

Edition 400
31582ZZ0000 Vanity unit

PRODUCT

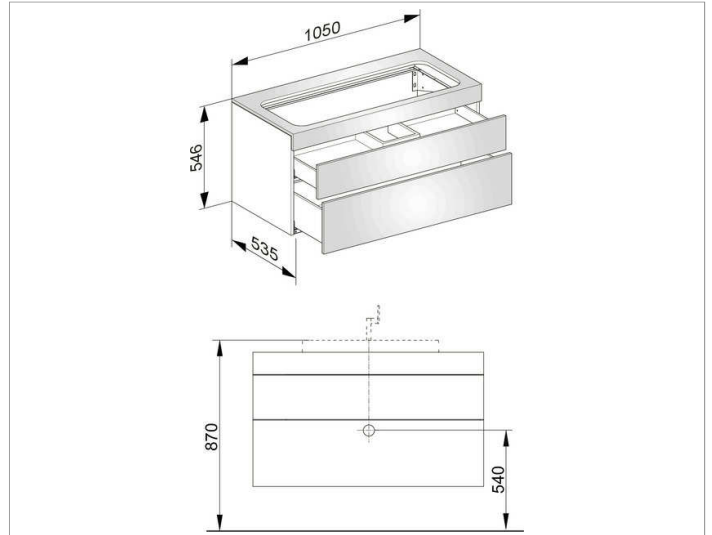

DRAWING



PRODUCT ATTRIBUTES

no tap hole,
compatible with ceramic washbasin Article No. 31580,
2 drawer fronts with push-to-open mechanism and
soft closing, incl. odour trap made of plastic 1 1/4 x 32

SURFACE

21, 40, 68, 80, 82, 84, 86, 87, 88, 96

DIMENSION

1050 x 546 x 535 mm