

Edition 400
31582XX0100 Vanity unit

PRODUCT

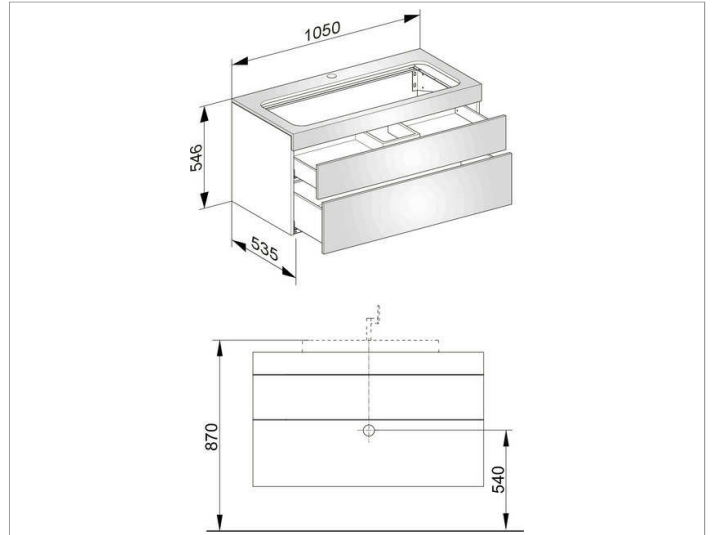

DRAWING



PRODUCT ATTRIBUTES

with tap hole,
compatible with ceramic washbasin Article No. 31580,
2 drawer fronts with push-to-open mechanism and
soft closing, incl. odour trap made of plastic 1 1/4 x 32

SURFACE

37,38,39,45,46,47

DIMENSION

1050 x 546 x 535 mm