

Edition 400
31573YY0100 Vanity unit

PRODUCT

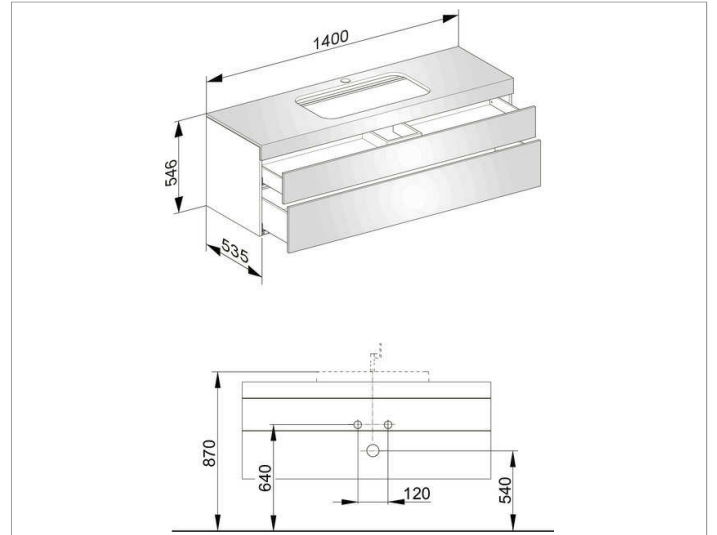

DRAWING



PRODUCT ATTRIBUTES

with tap hole,
compatible with ceramic washbasin Article No. 31570,
2 drawer fronts with push-to-open mechanism and
soft closing, incl. odour trap made of plastic 1 1/4 x 32

SURFACE

11,13,14,15,16,17,18,27,28,30,43,53,70,71,72,73,74,75,76,77,78,79

DIMENSION

1400 x 546 x 535 mm