

Crometta

Shower holder set 100 1jet EcoSmart 9 l/min with shower hose 160 cm

Surfaces: **white/chrome** Art. no. : **26569400**



Description

product features

- Consists of: hand shower, shower holder, shower hose
- Shower head size: 100 mm
- Spray pattern: Rain
- Maximum flow rate (at 3 bar): 9 l/min
- pivot connector prevent hose from tangling
- wall supports of plastic

Article Details

Price excl. VAT

£ 33.33

Technology



Product image

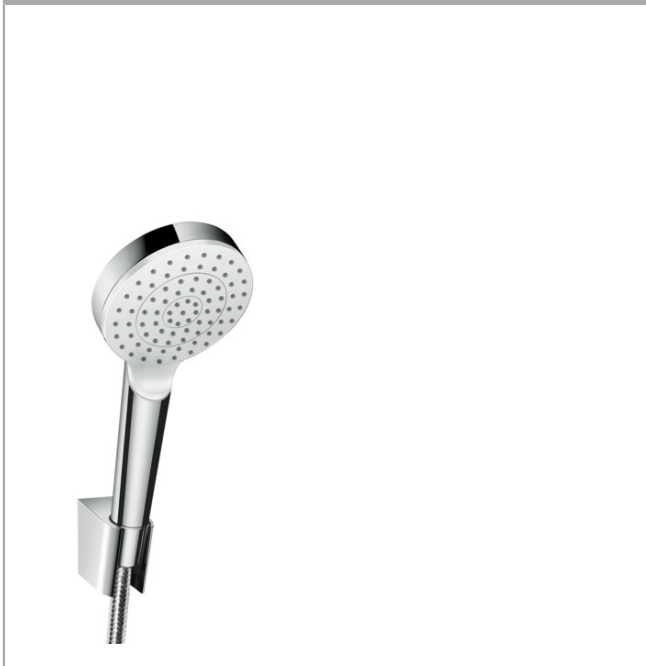

Scale drawing

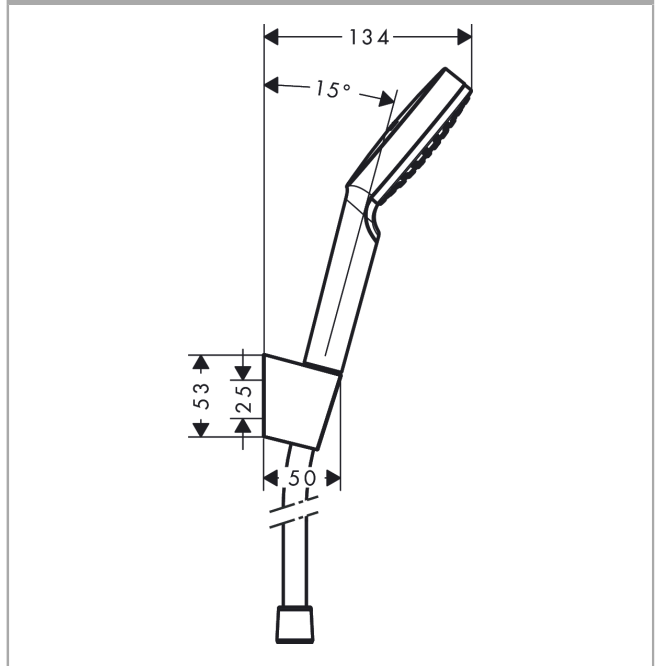

Flowchart

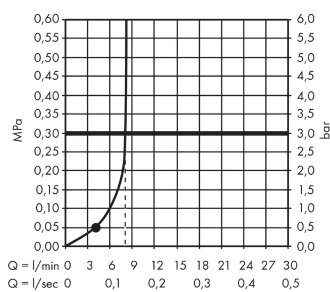

The consumption was measured in combination with the appropriate fittings (thermostat/mixer/ in-wall valve) to reflect actual application in practice.