

Royal Lumos

14302171331 Mirror cabinet

PRODUCT



DRAWING

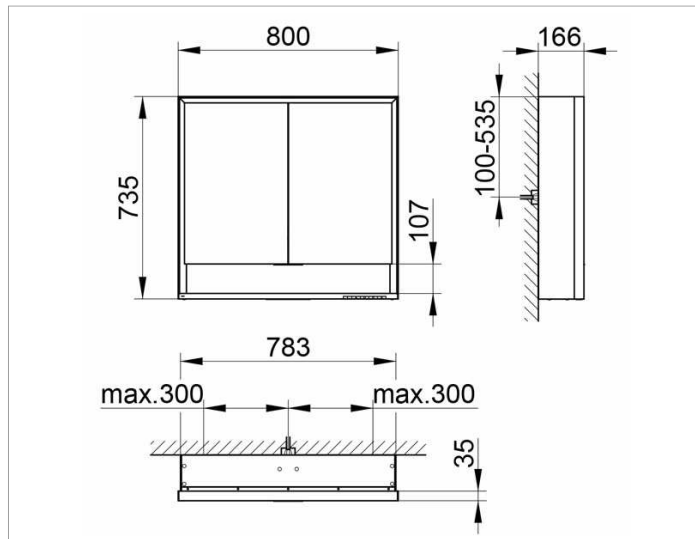

PRODUCT ATTRIBUTES

wall mounted,
adjustable light colour from 2700 kelvin (warm white)
to 6500 kelvin (daylight),
2 hinged double sided crystal mirrored doors,
Body: aluminium silver anodized
Body panels made from rear-lacquered white glass
interior rear wall mirrored

Operation:

key panel with capacitive touch sensor,
integrated extension function for e.g. light switch

Illumination:

frame lighting and washbasin/shelf light separately,
infinitely dimmable and can be switched on/off
LED 56 watt (lifespan > 30.000 hours)
infinitely dimmable, lamps non-exchangeable
EEK: A++, A+, A , 56 kWh/1000h

EQUIPMENT

- 1 shaver socket
- 2 x 2 adjustable glass shelves
- storage space across full width
- soft-closing doors

SURFACE

silver anodized

DIMENSION

800 x 735 x 165 mm