

D34027-002&BDC © 06-2009

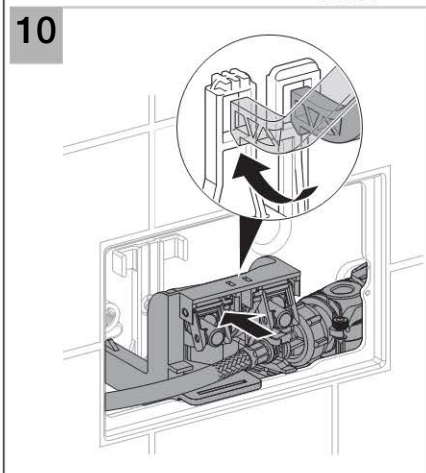

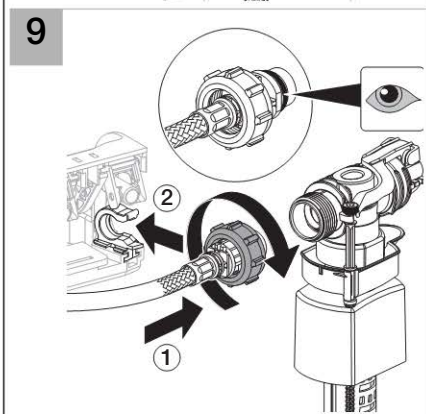

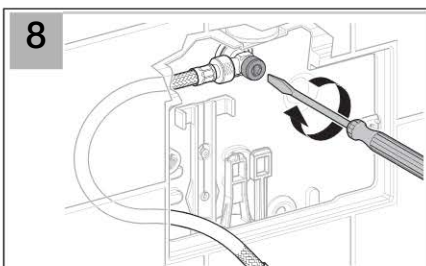

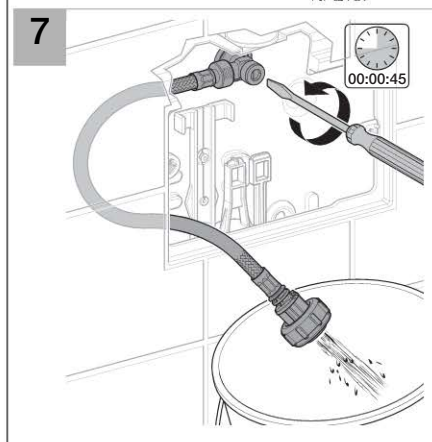
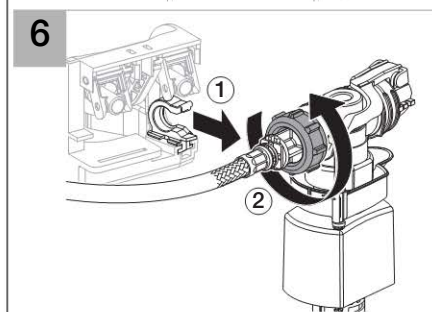
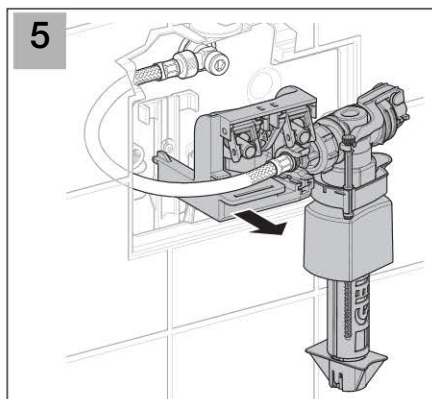
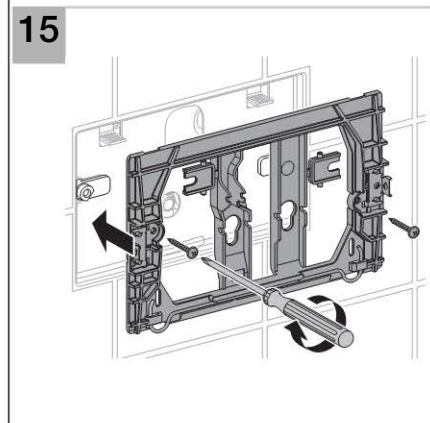
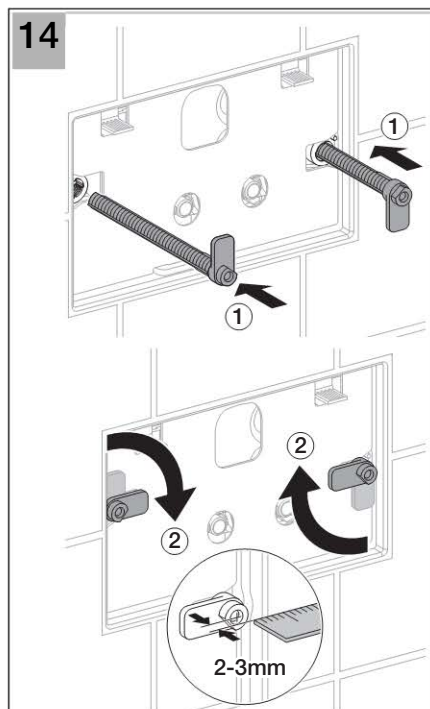
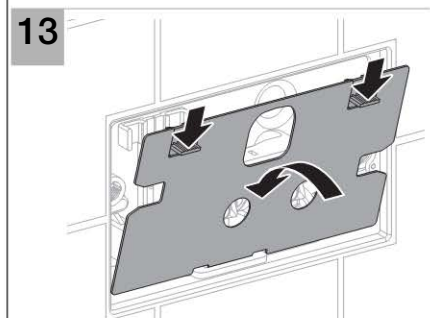
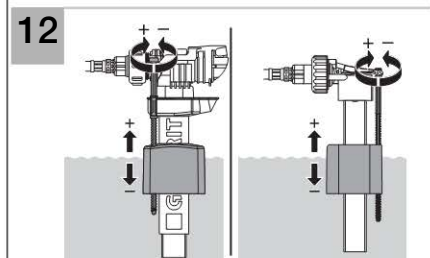
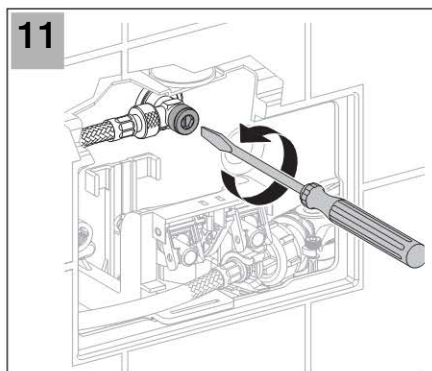
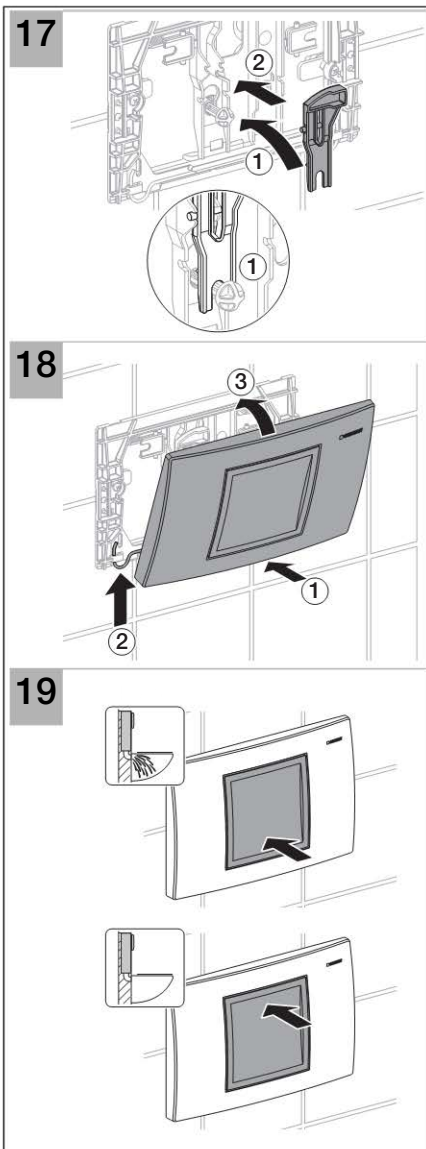
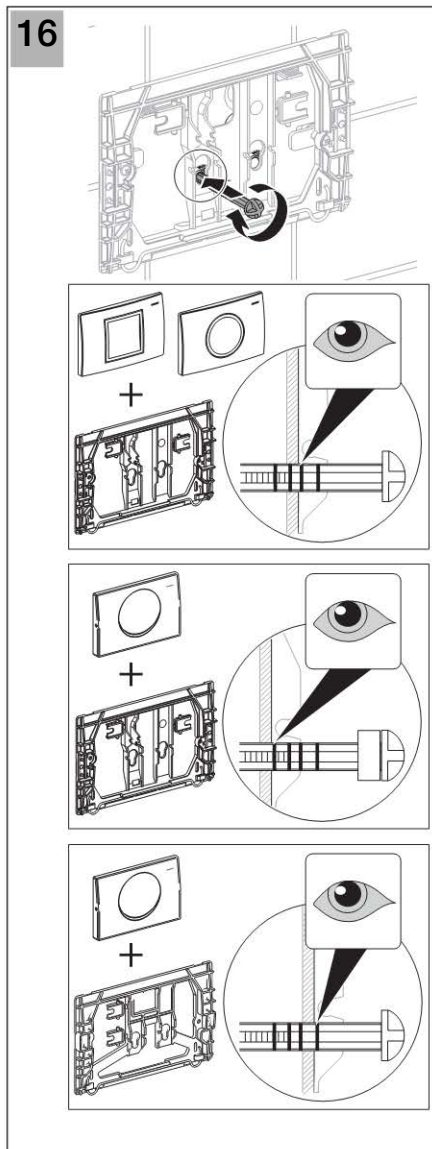
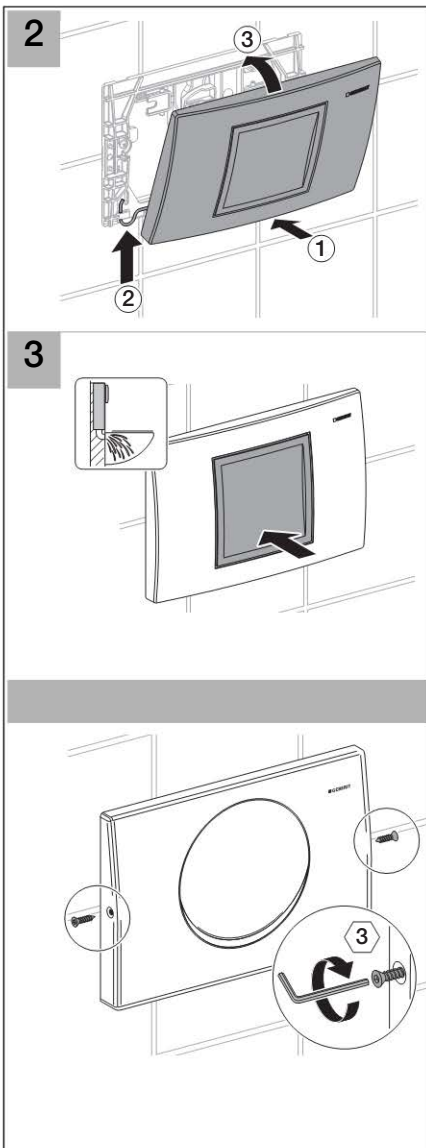
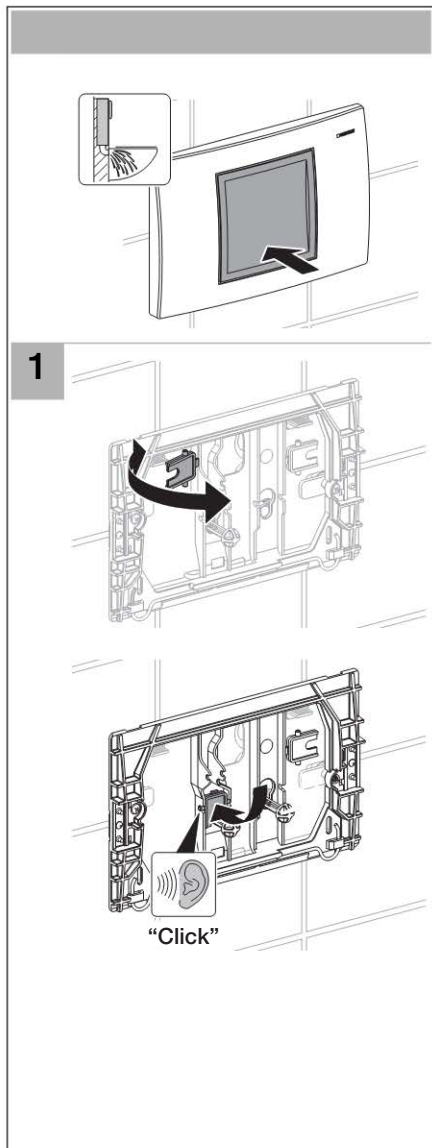

Geberit International AG
Schachenstrasse 77
CH-8645 Jona
www.geberit.com
dokumentation@geberit.com

D34027-002&BDC © 06-2009