

Installation

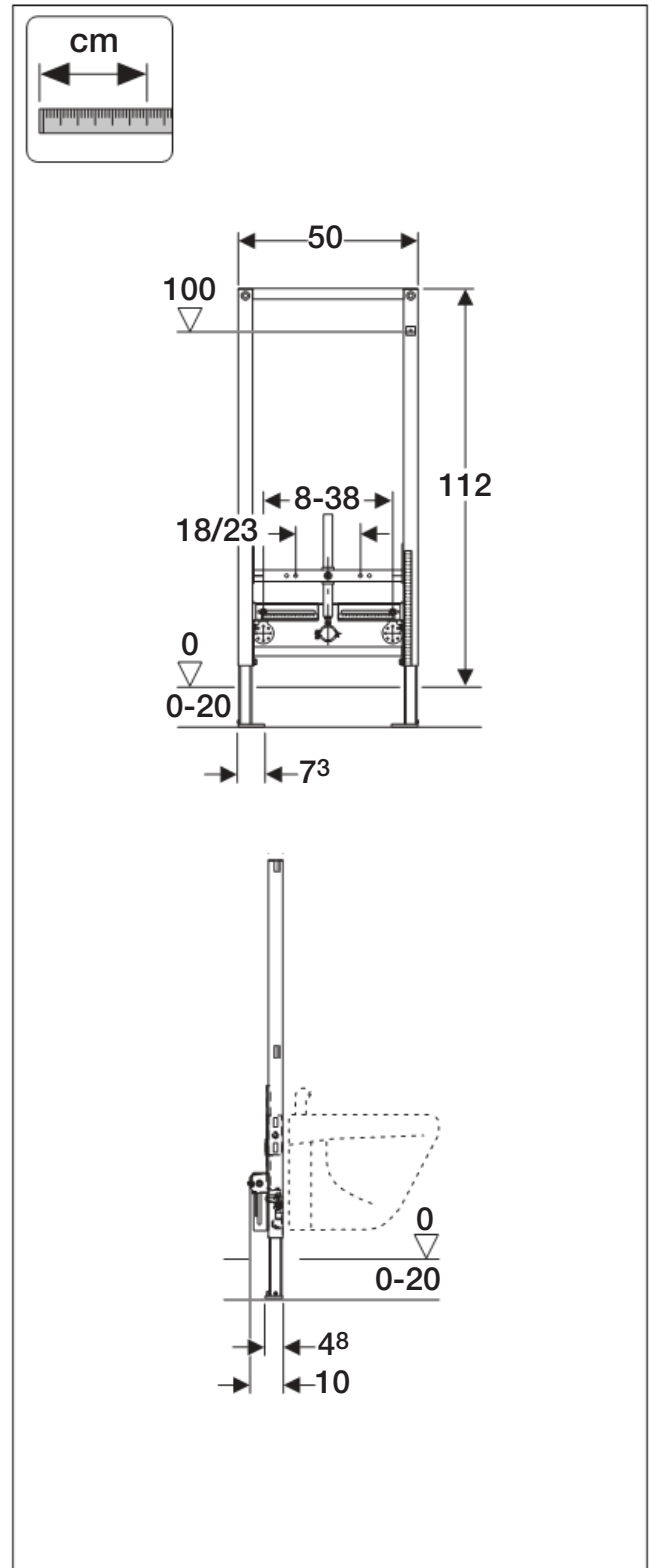

D25114-001&BDC © 02-2008

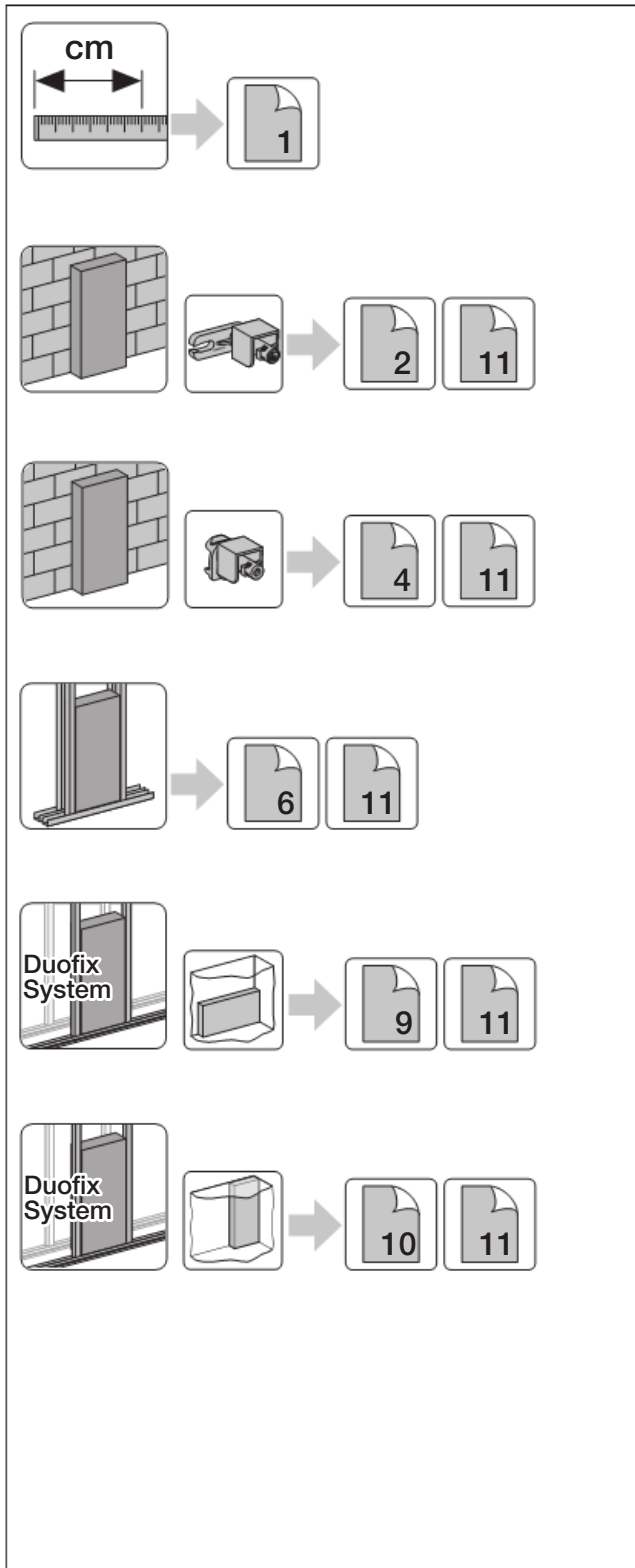

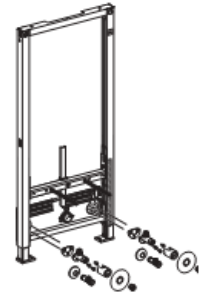
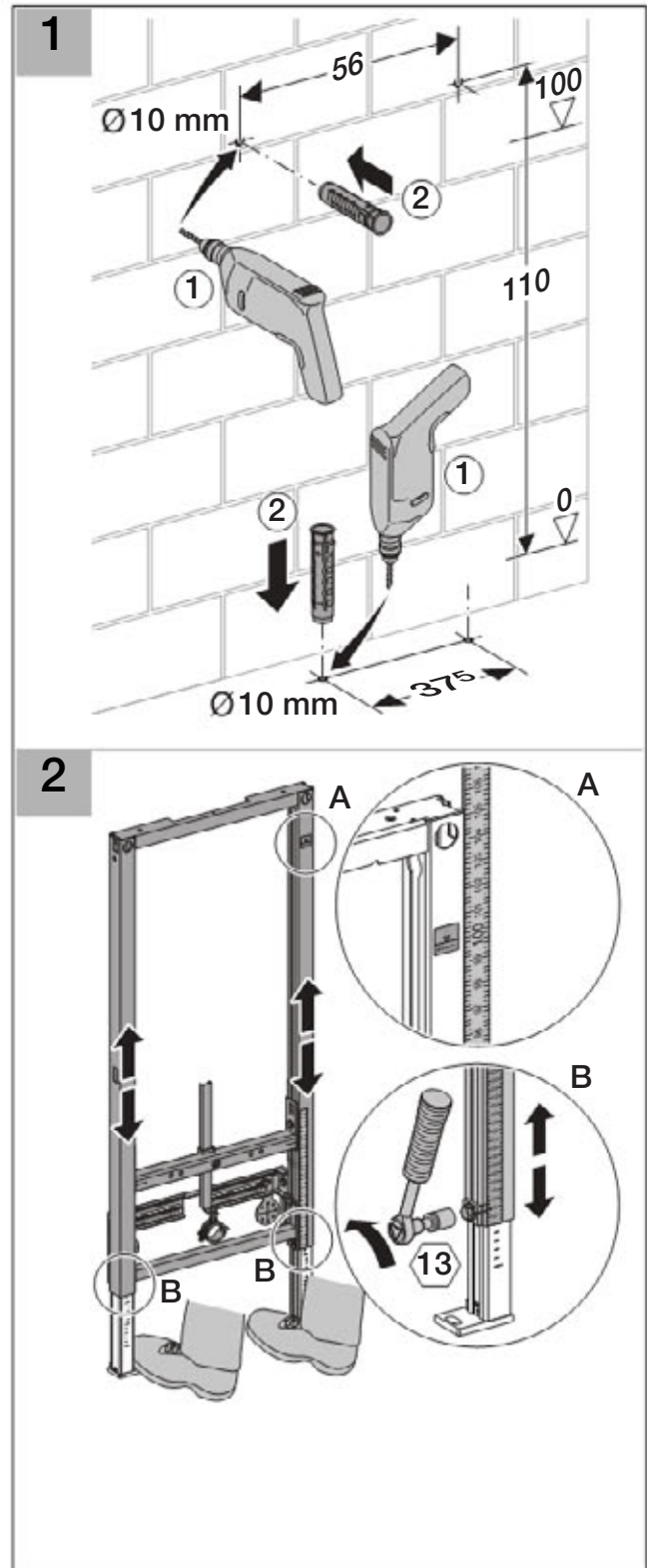
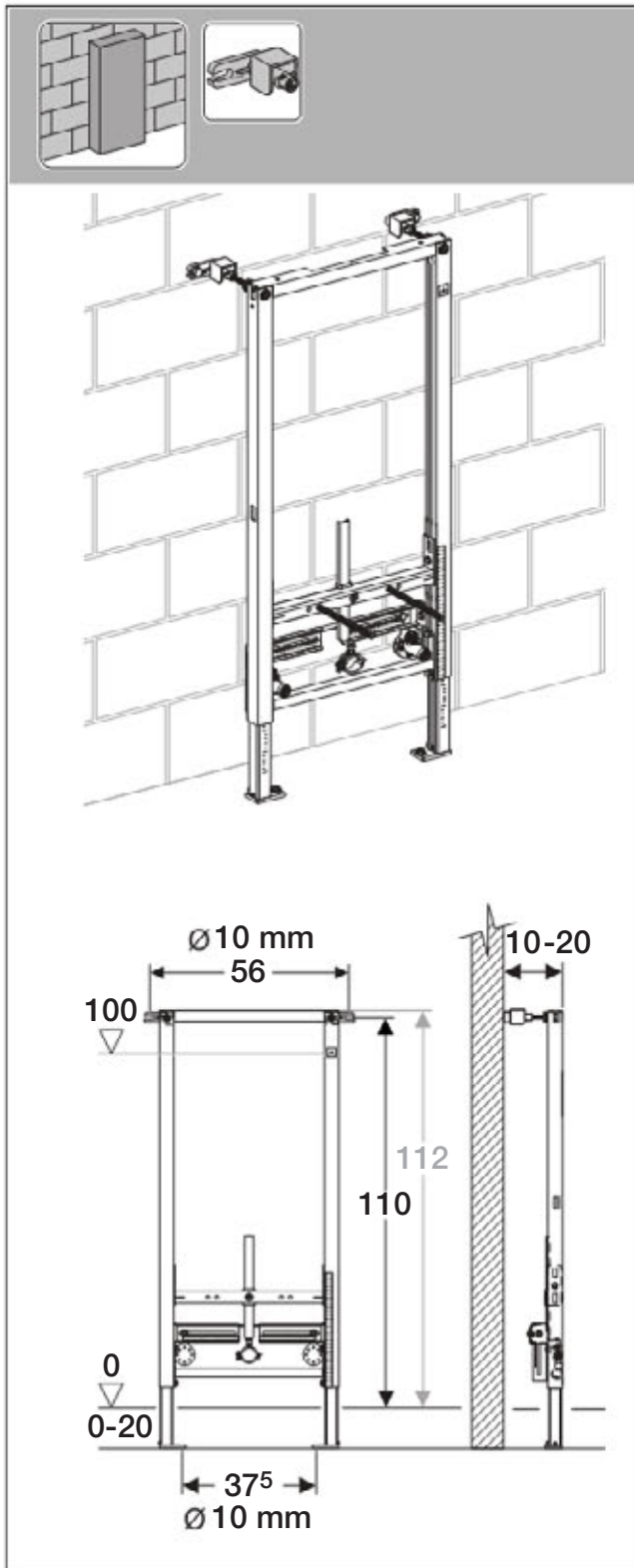
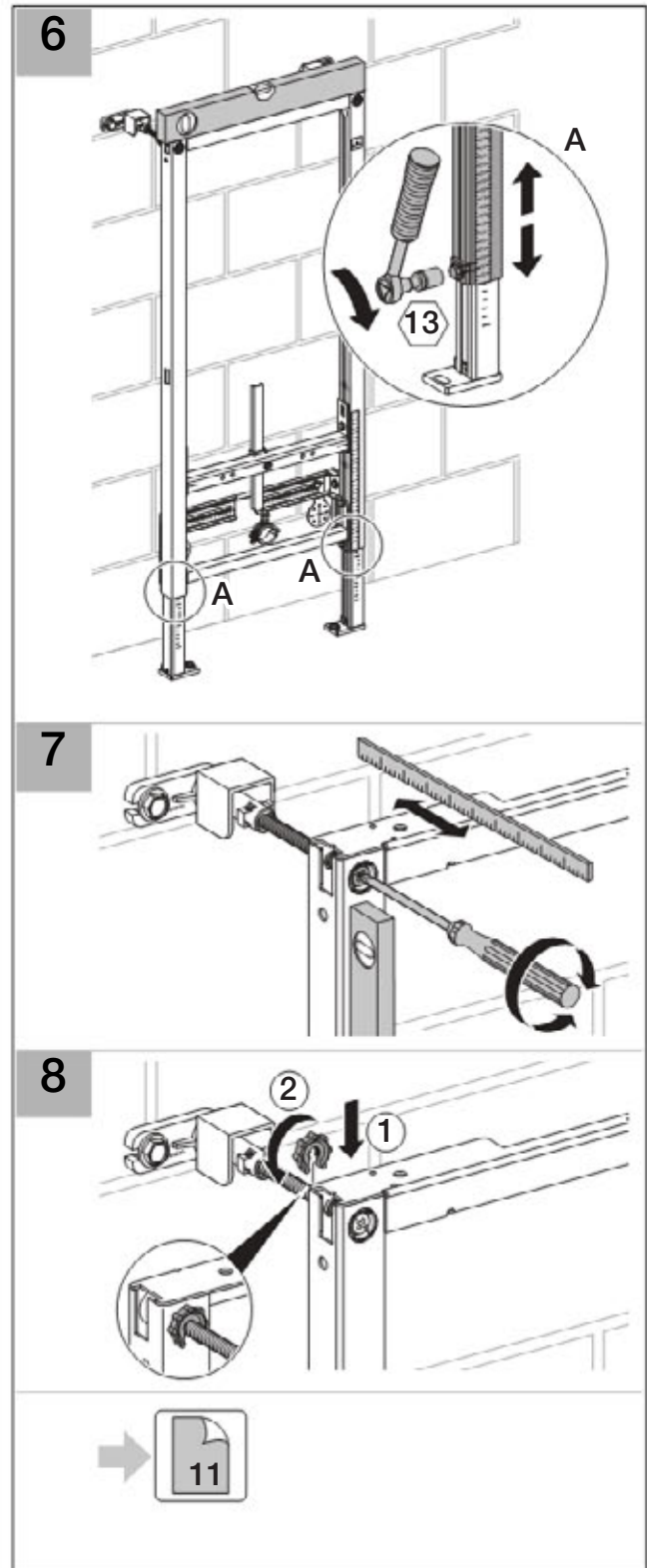
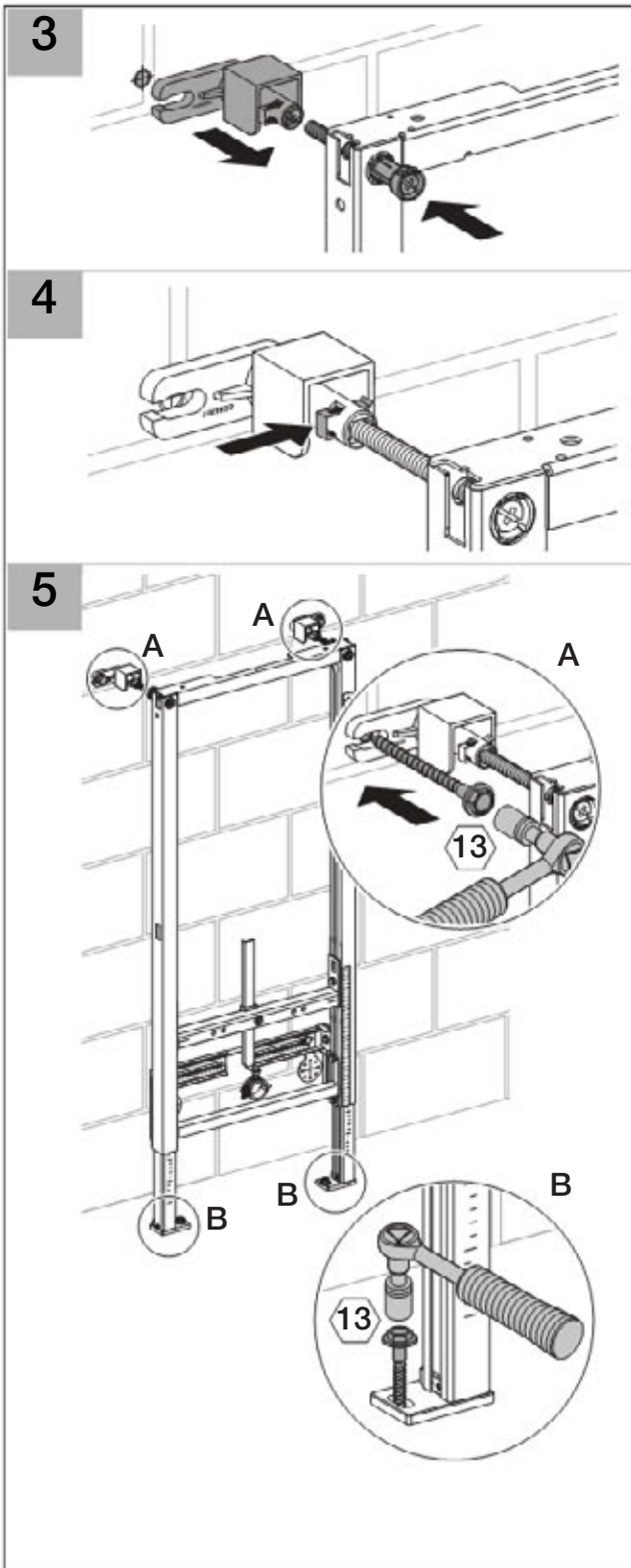

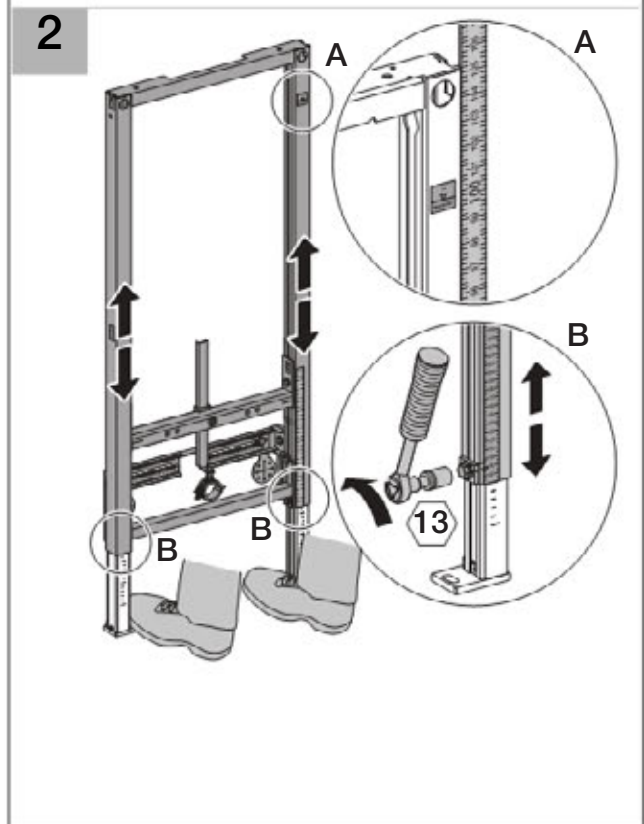
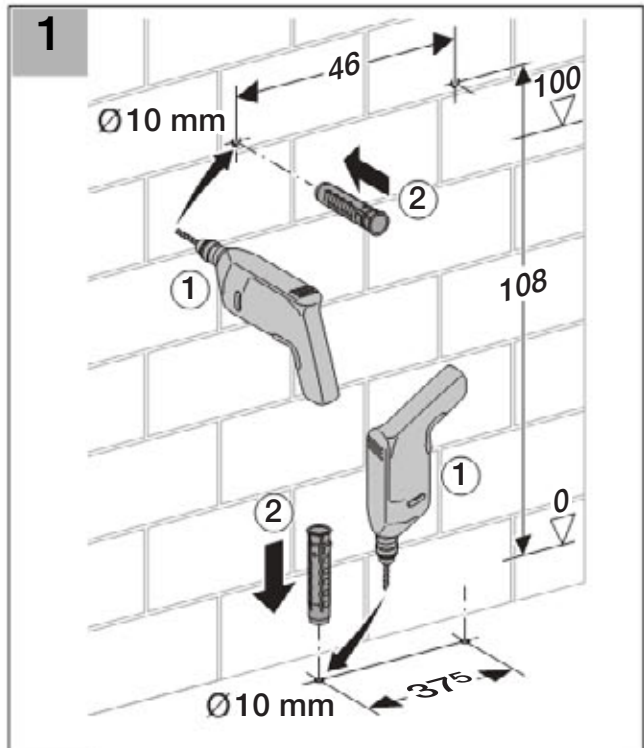
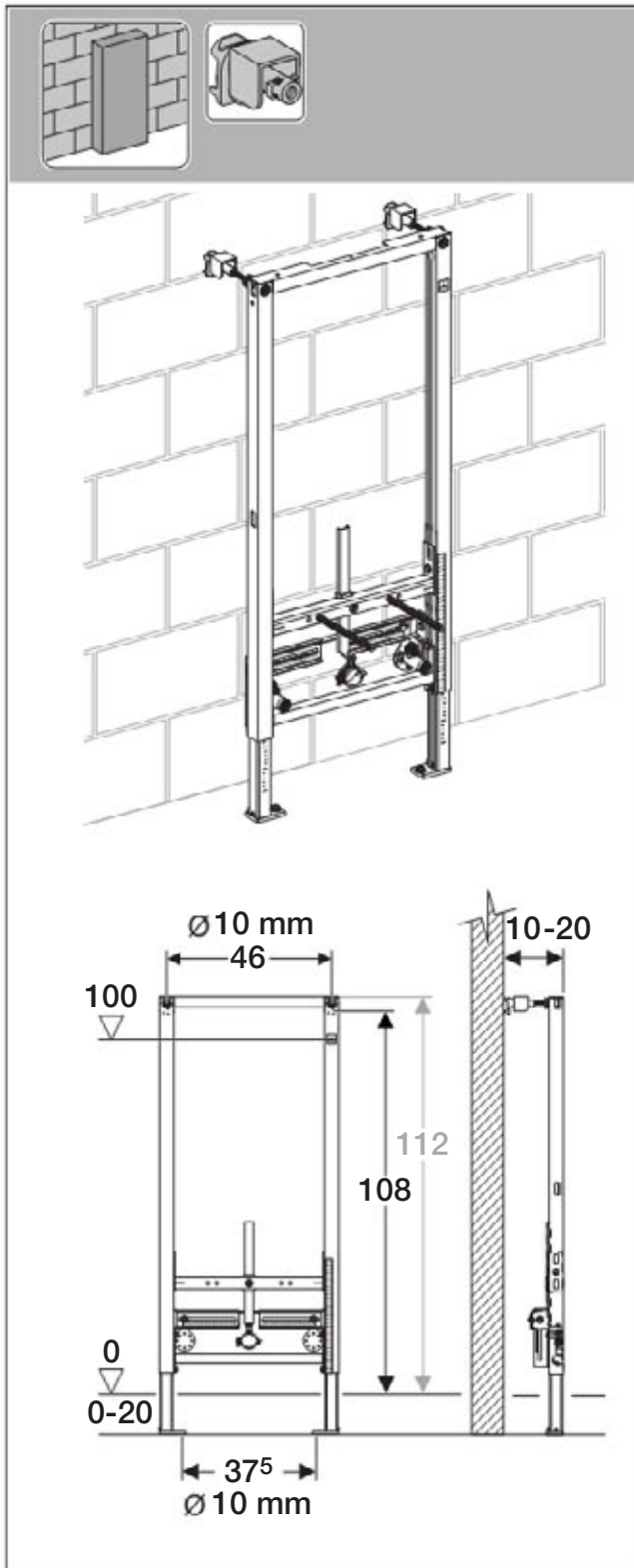

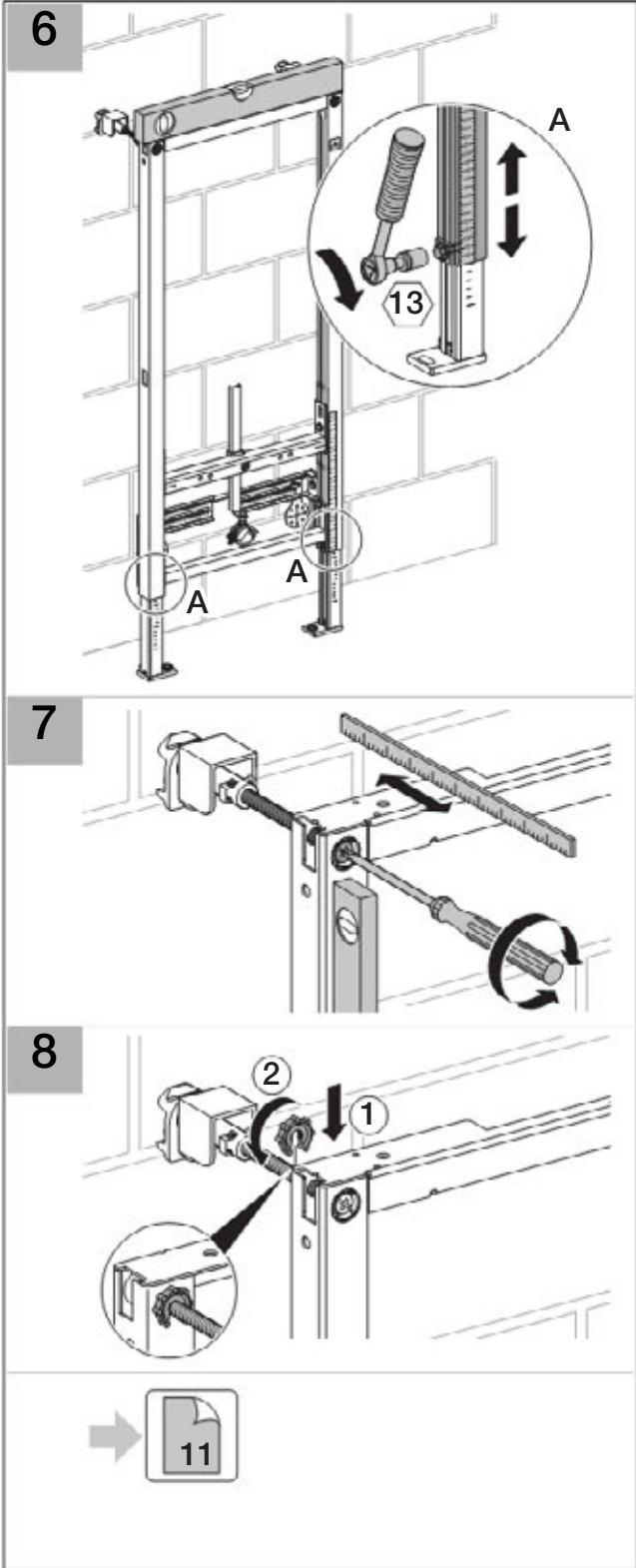
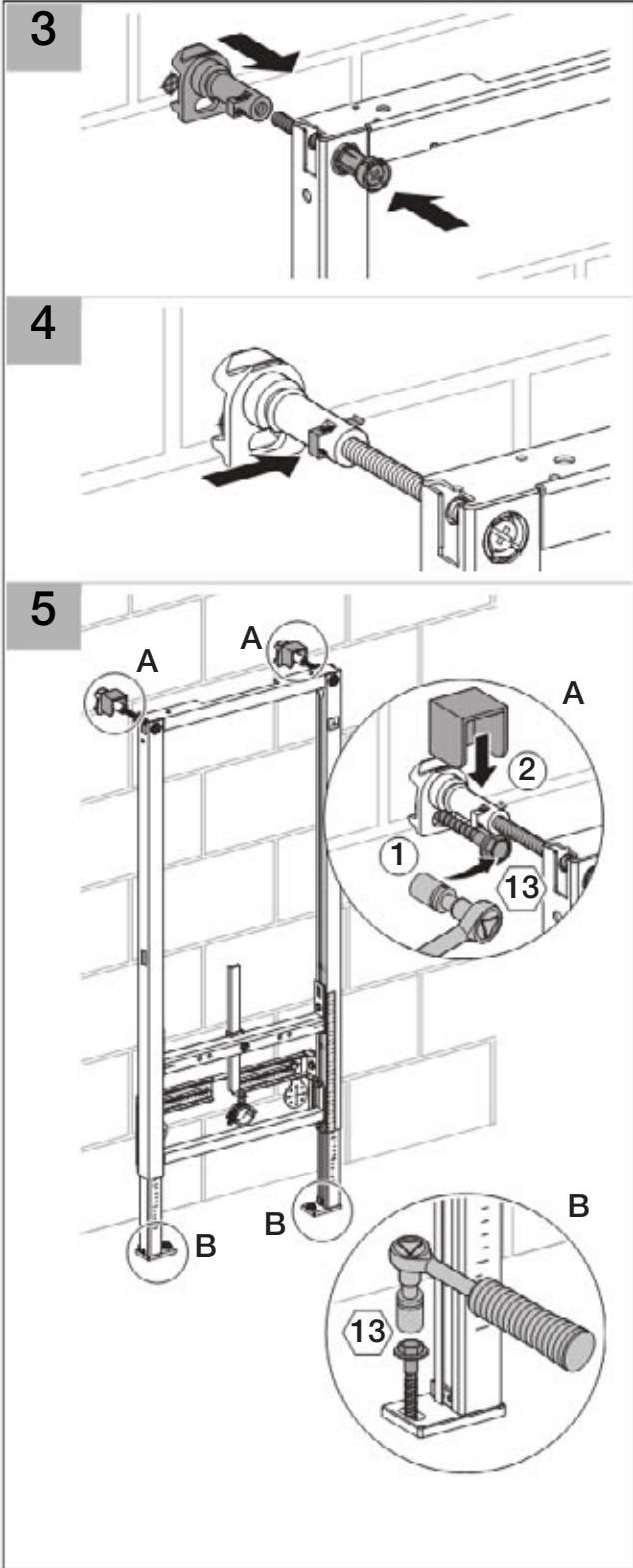

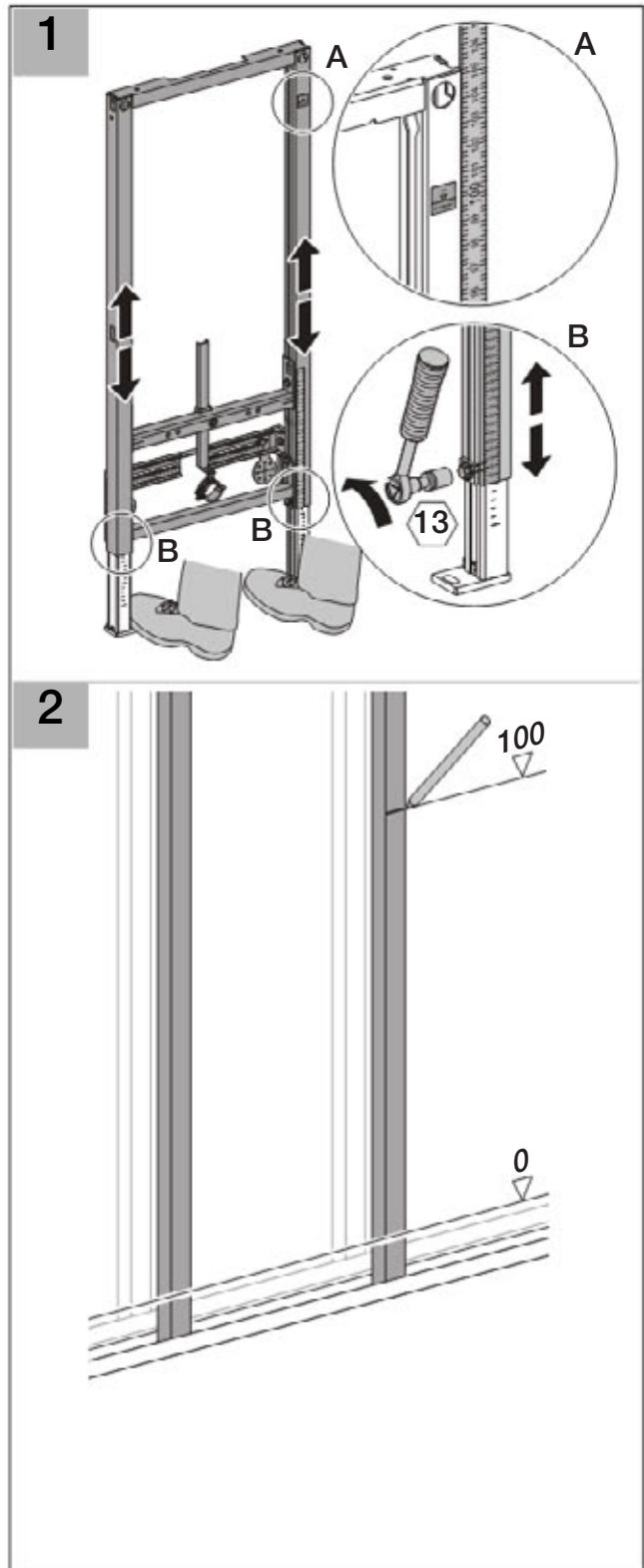
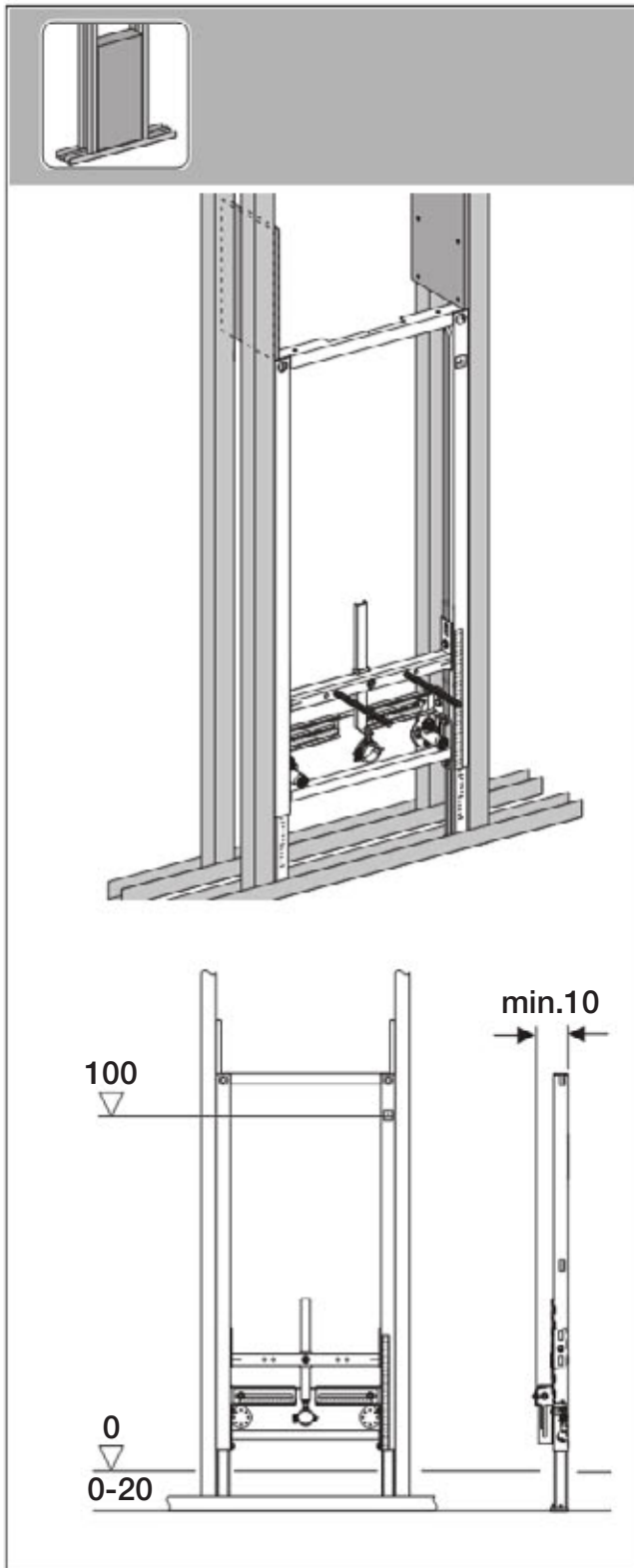

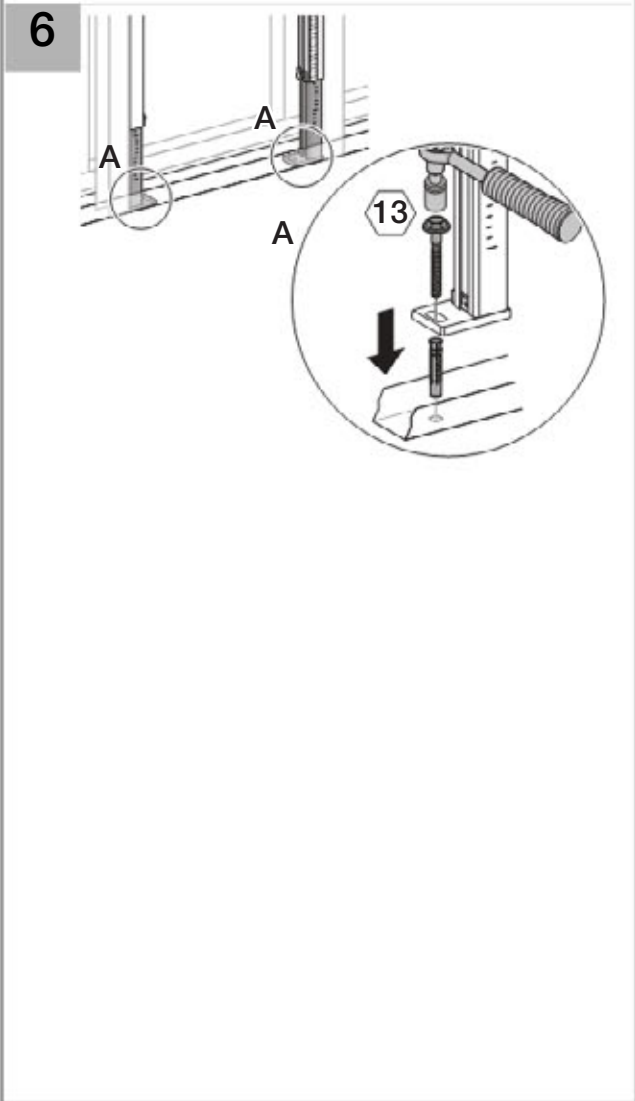
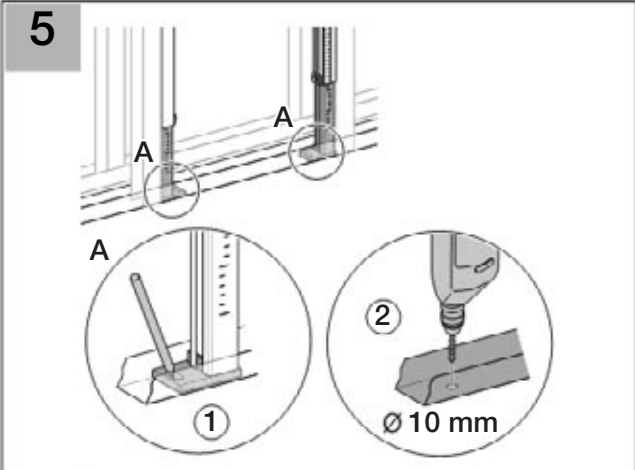
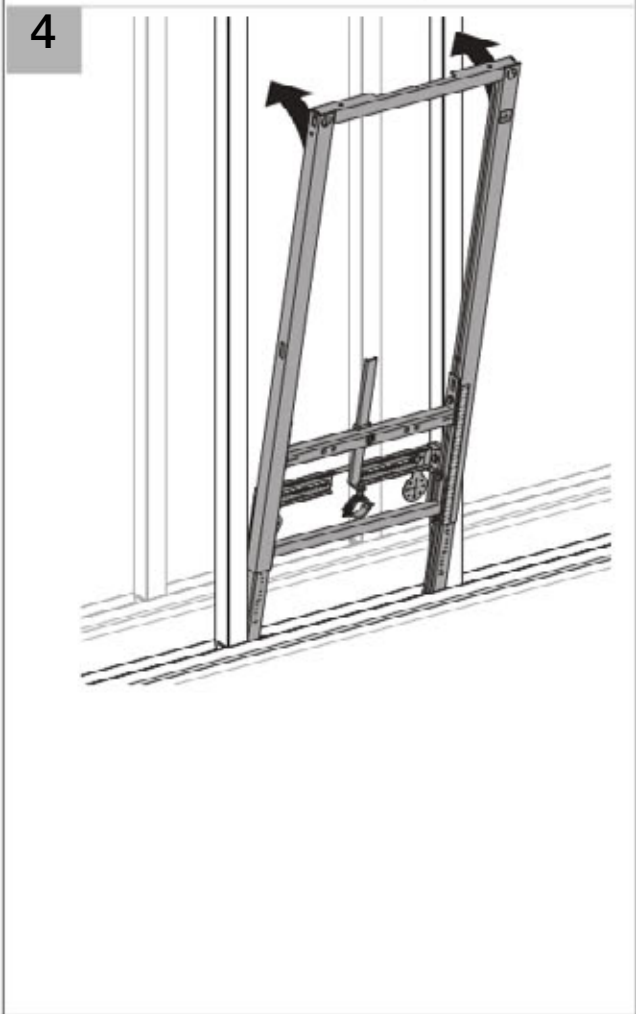
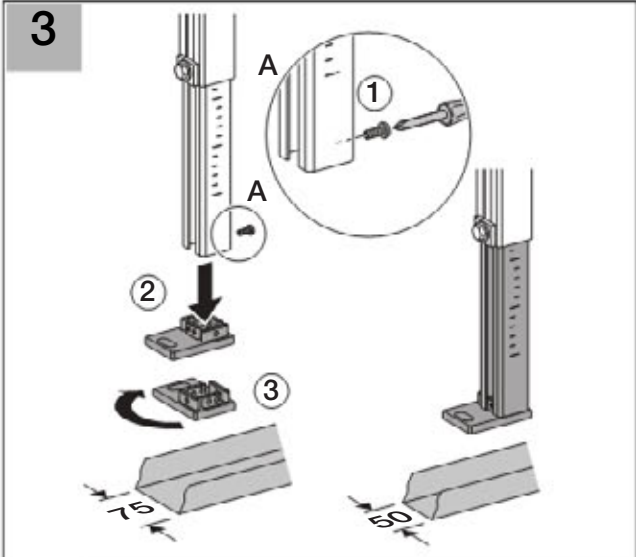

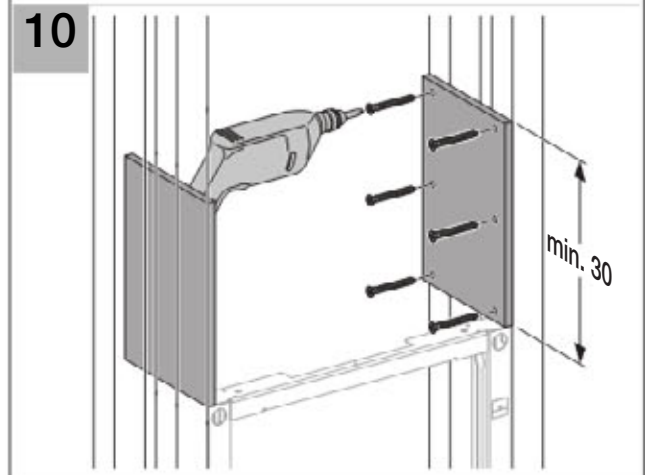
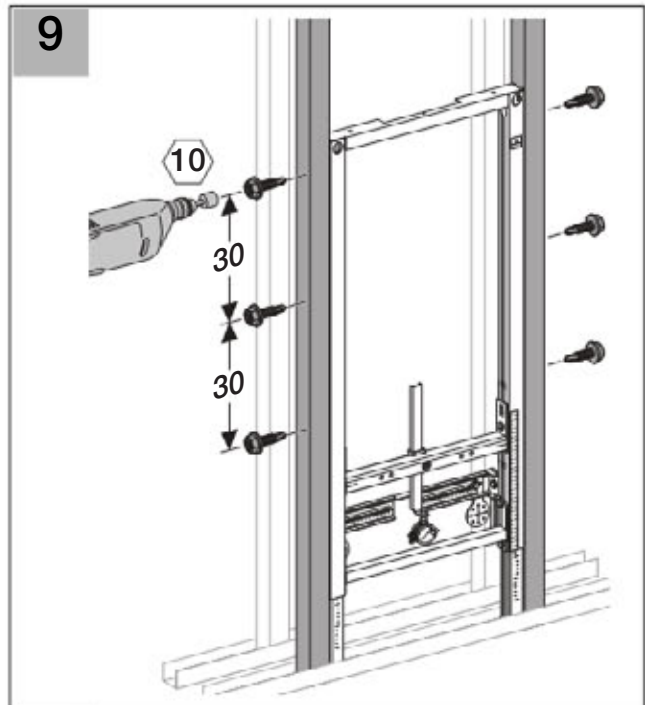
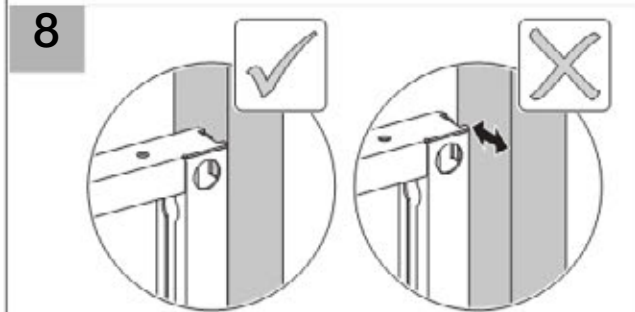
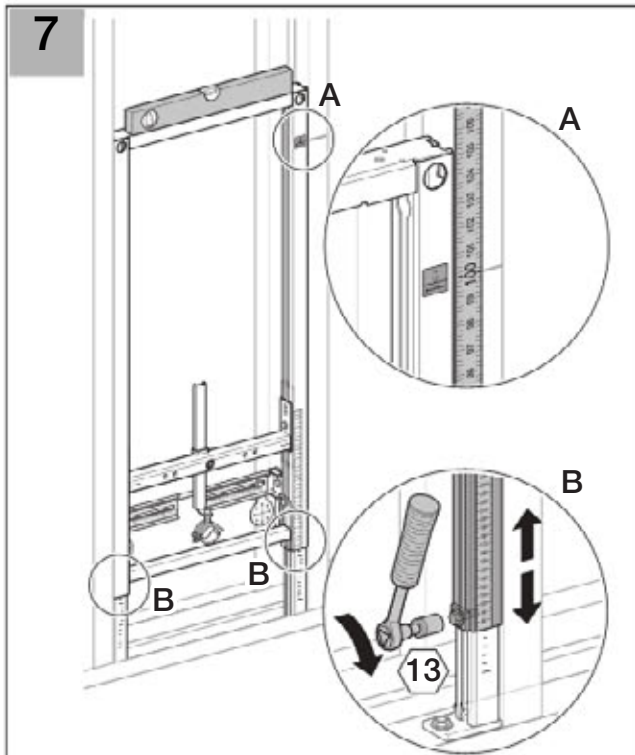

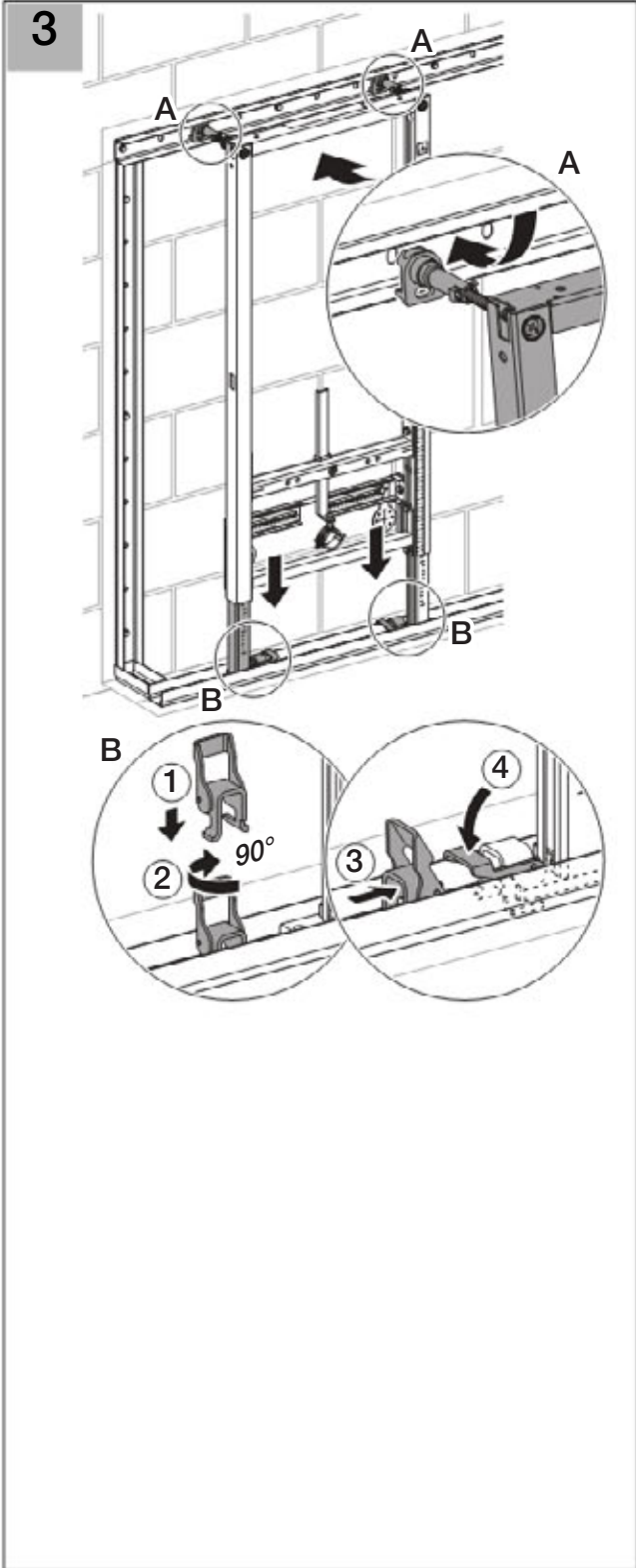
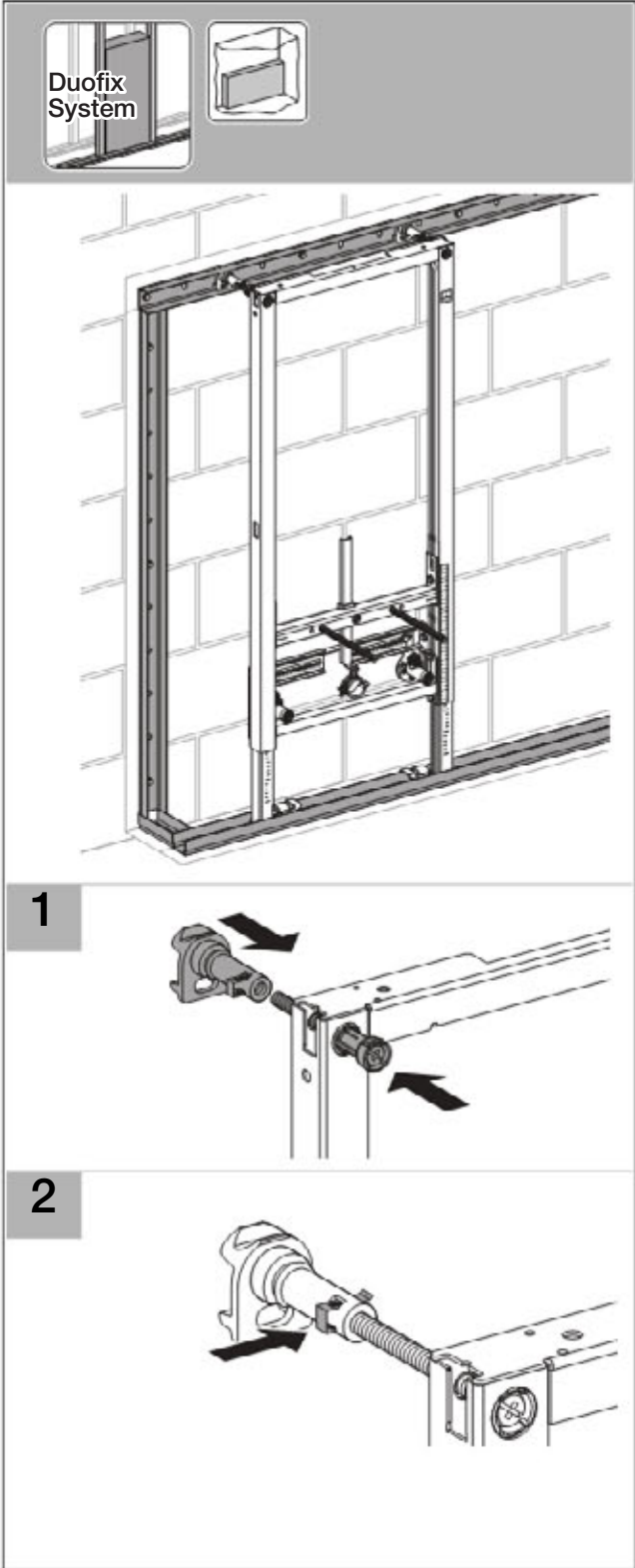

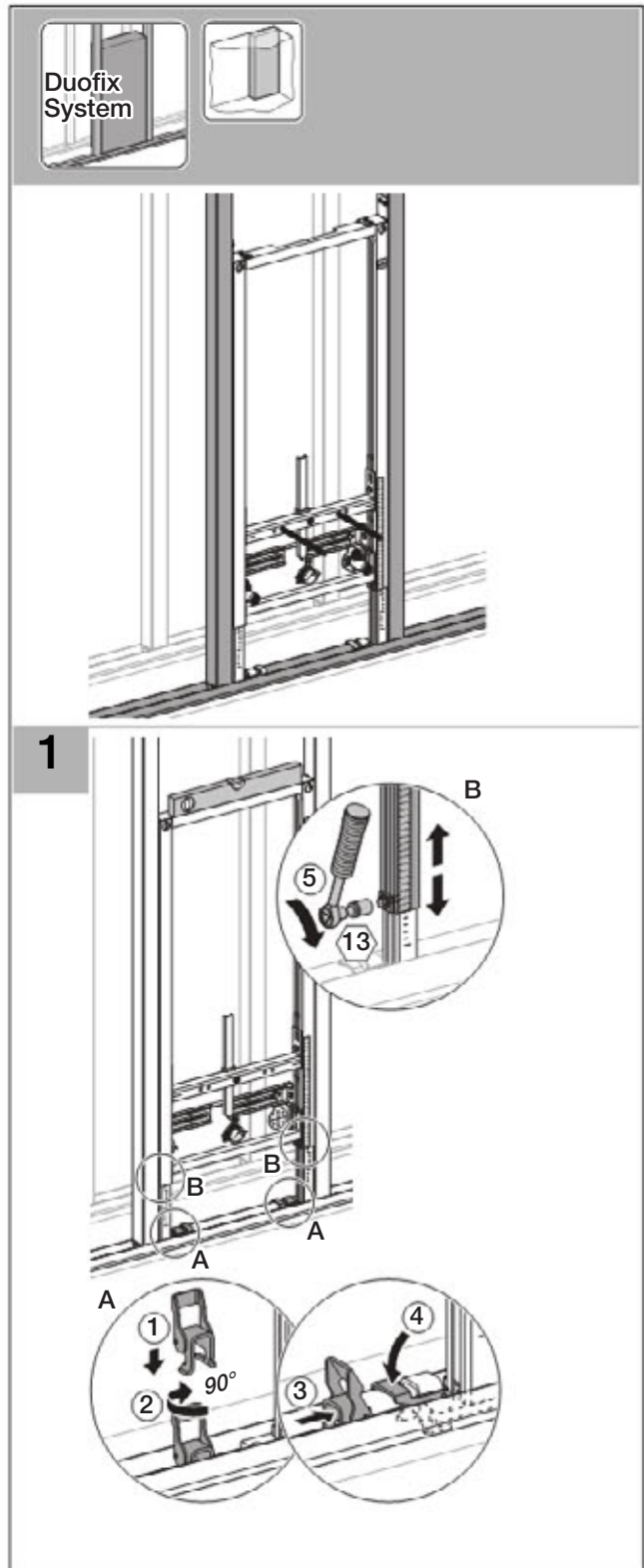
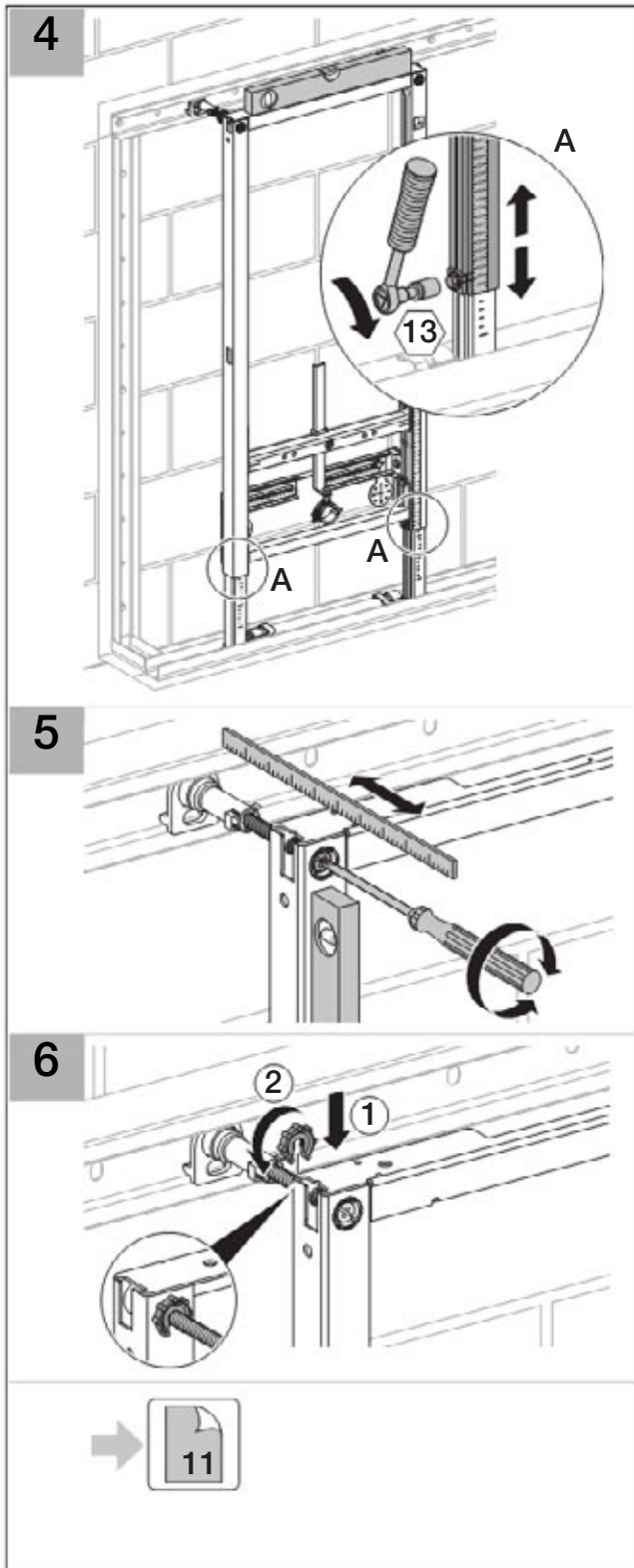

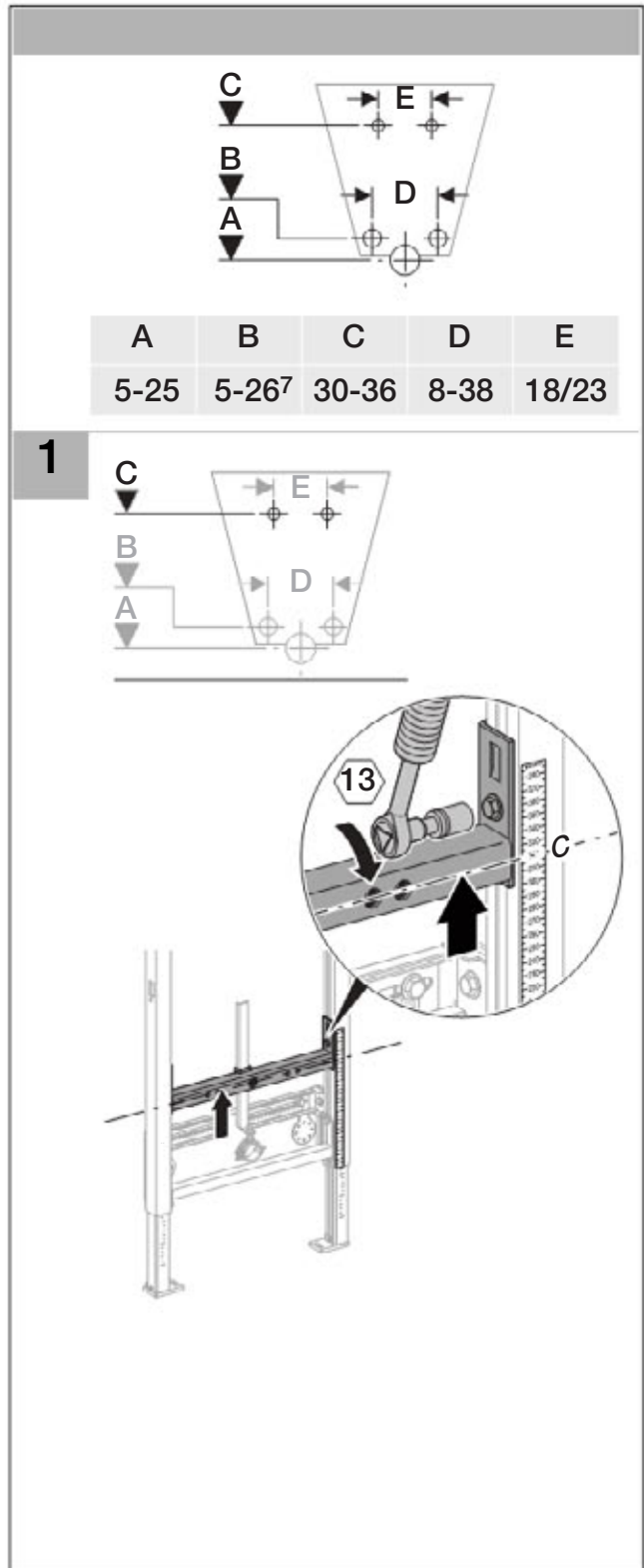
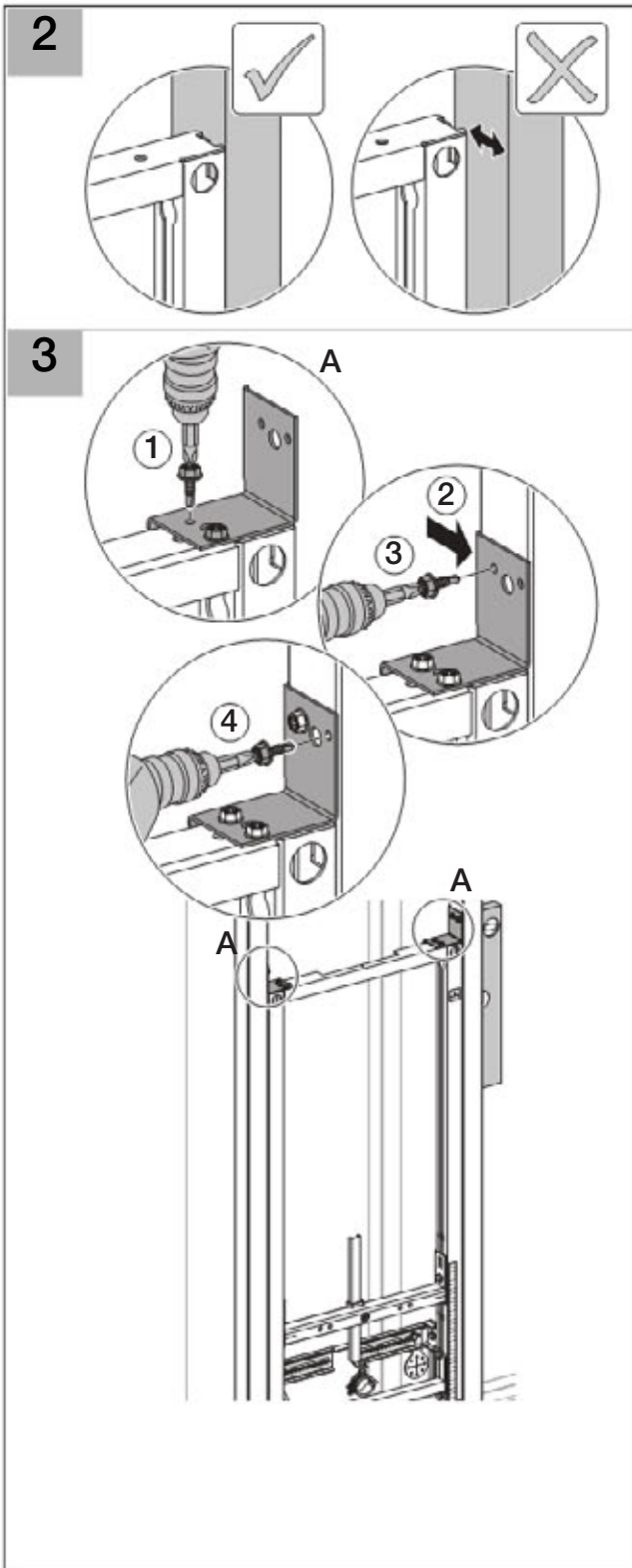

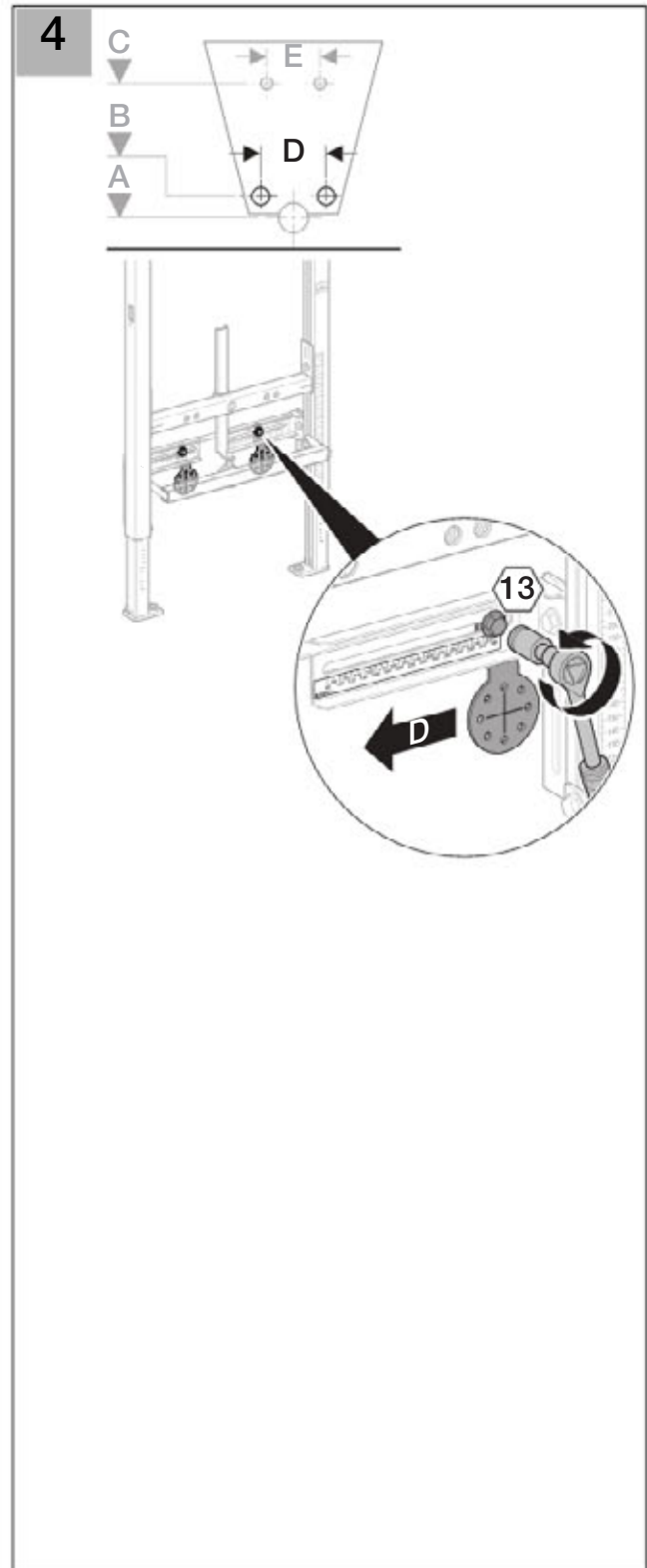
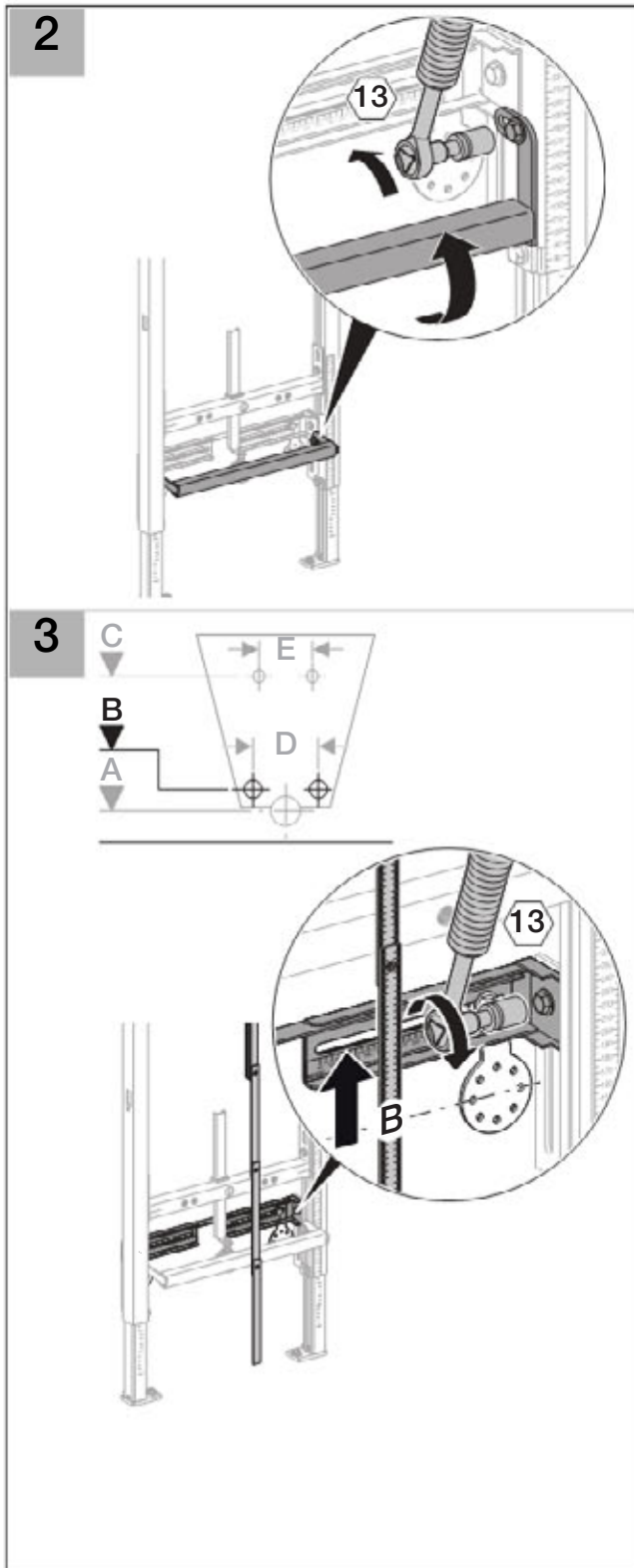

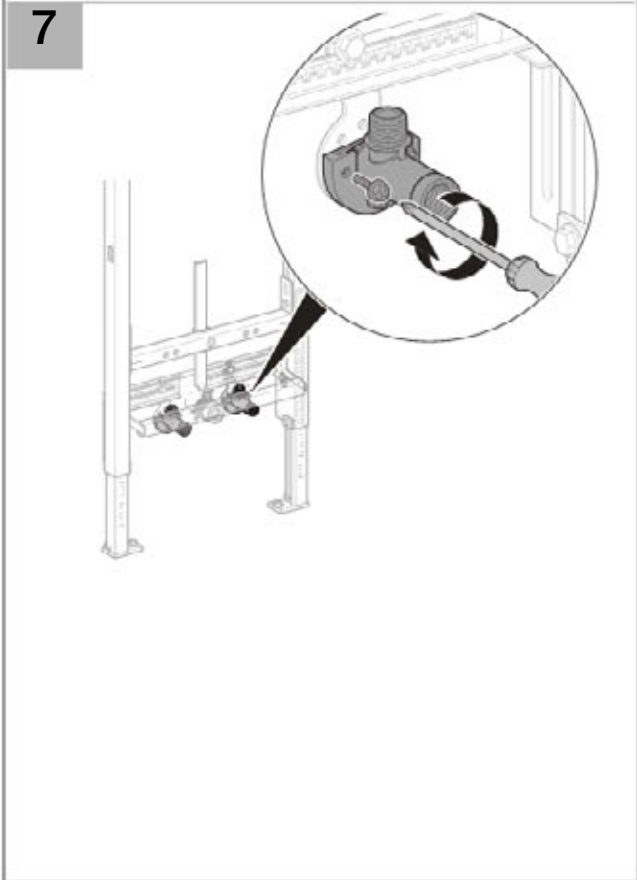
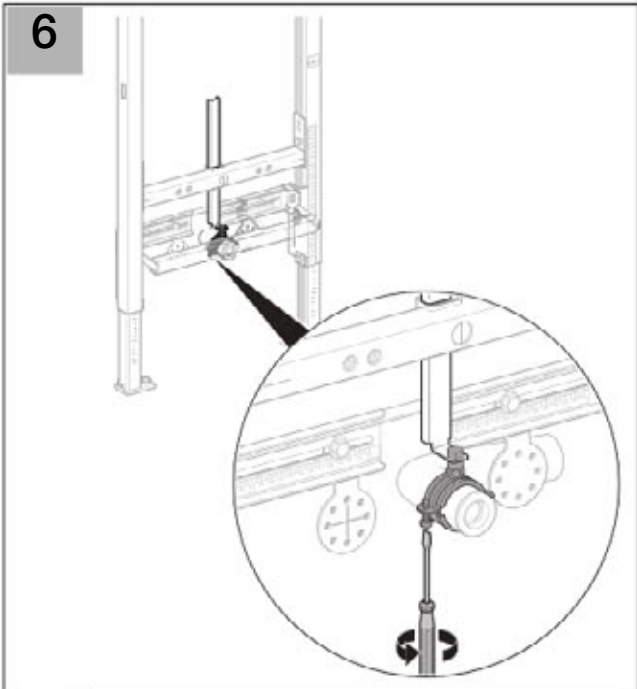
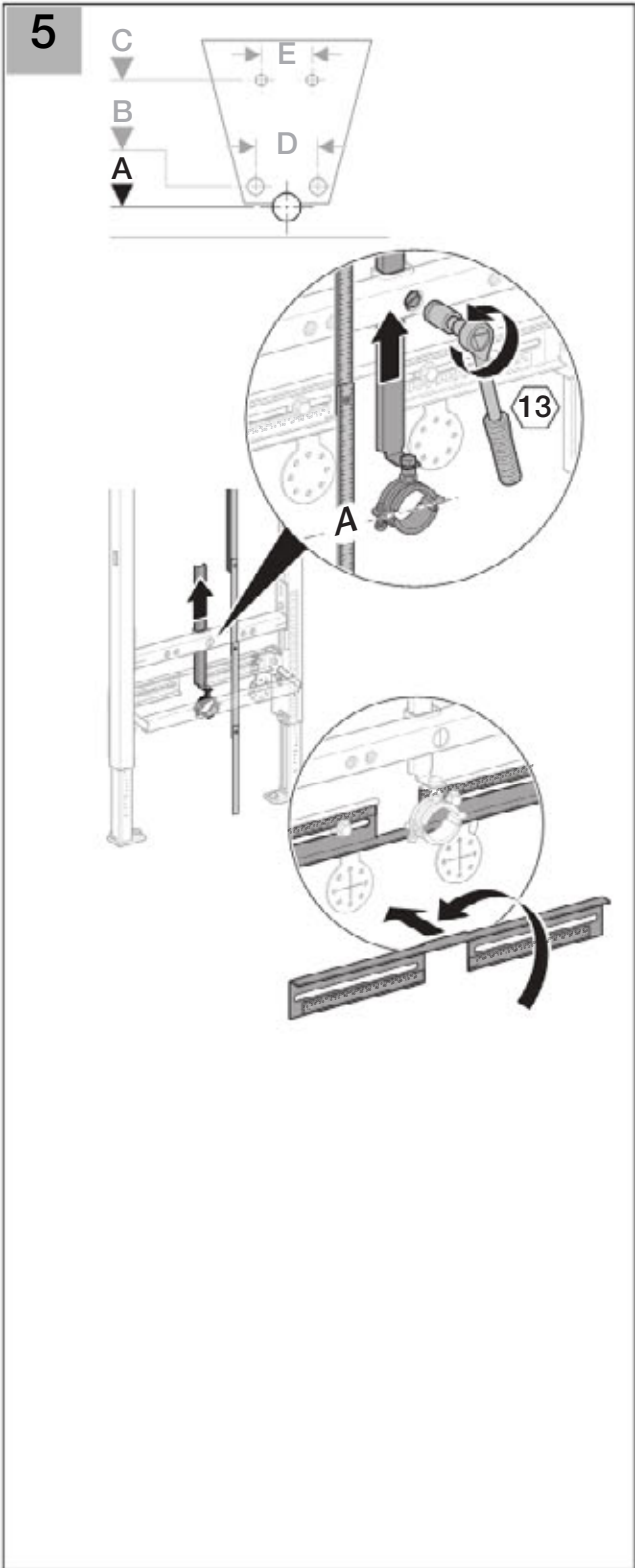

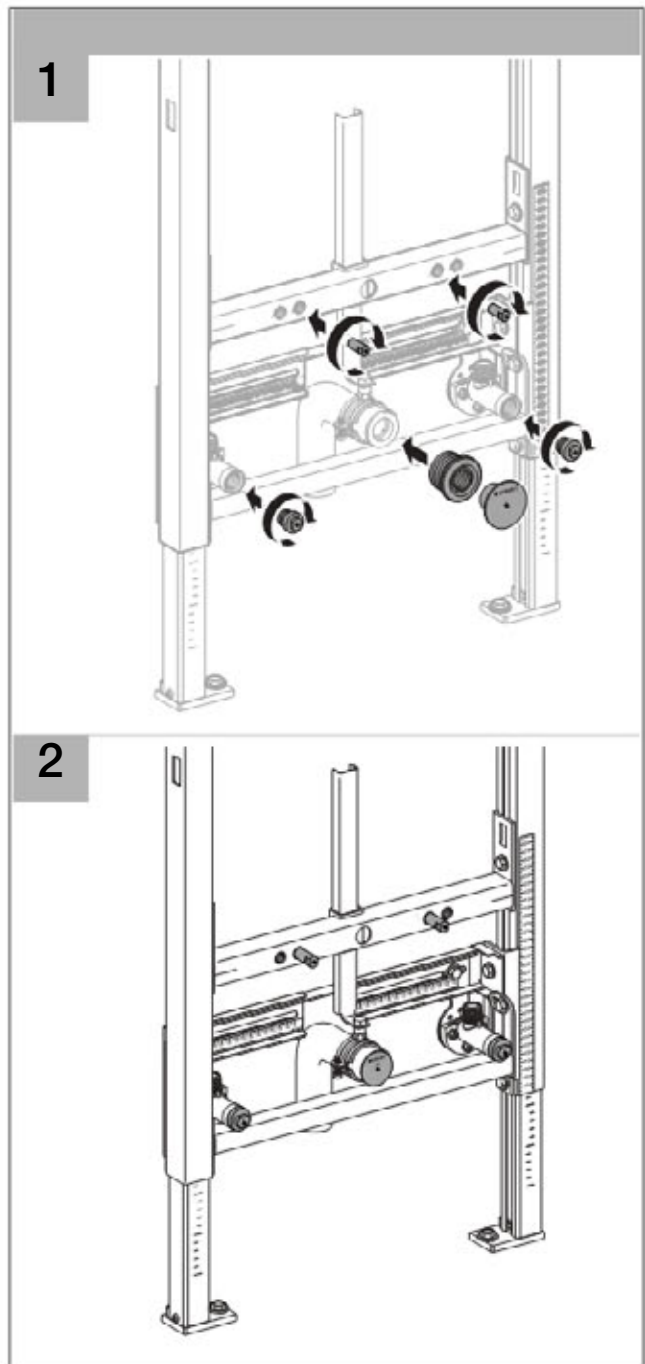
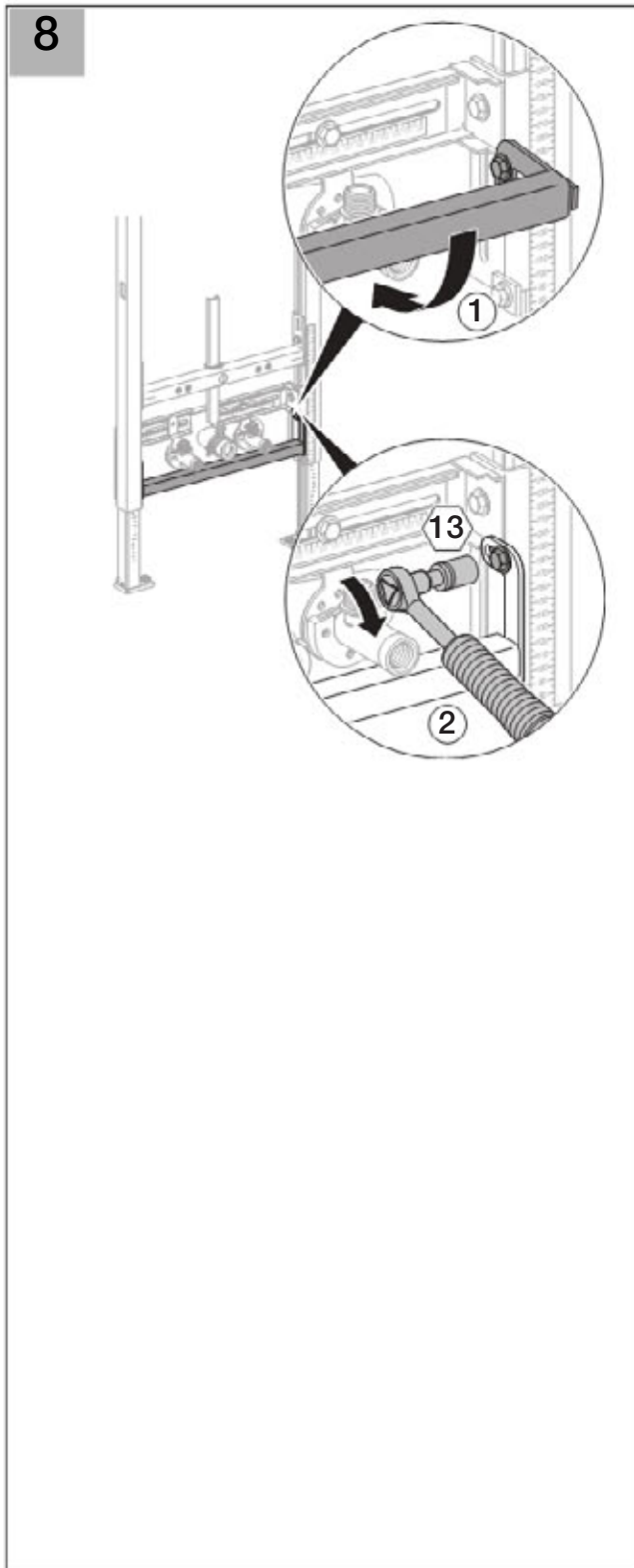

Geberit International AG
Schachenstrasse 77
CH-8645 Jona
www.geberit.com
dokumentation@geberit.com

D25114-001&BDC © 02-2008