

Model ECX20 - External Single Halyard

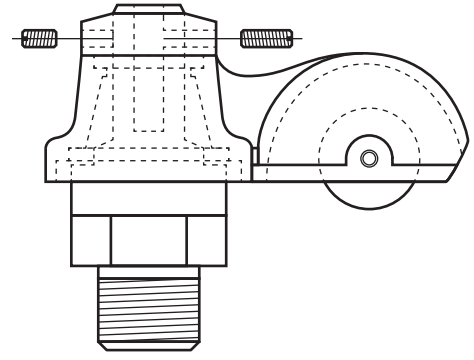
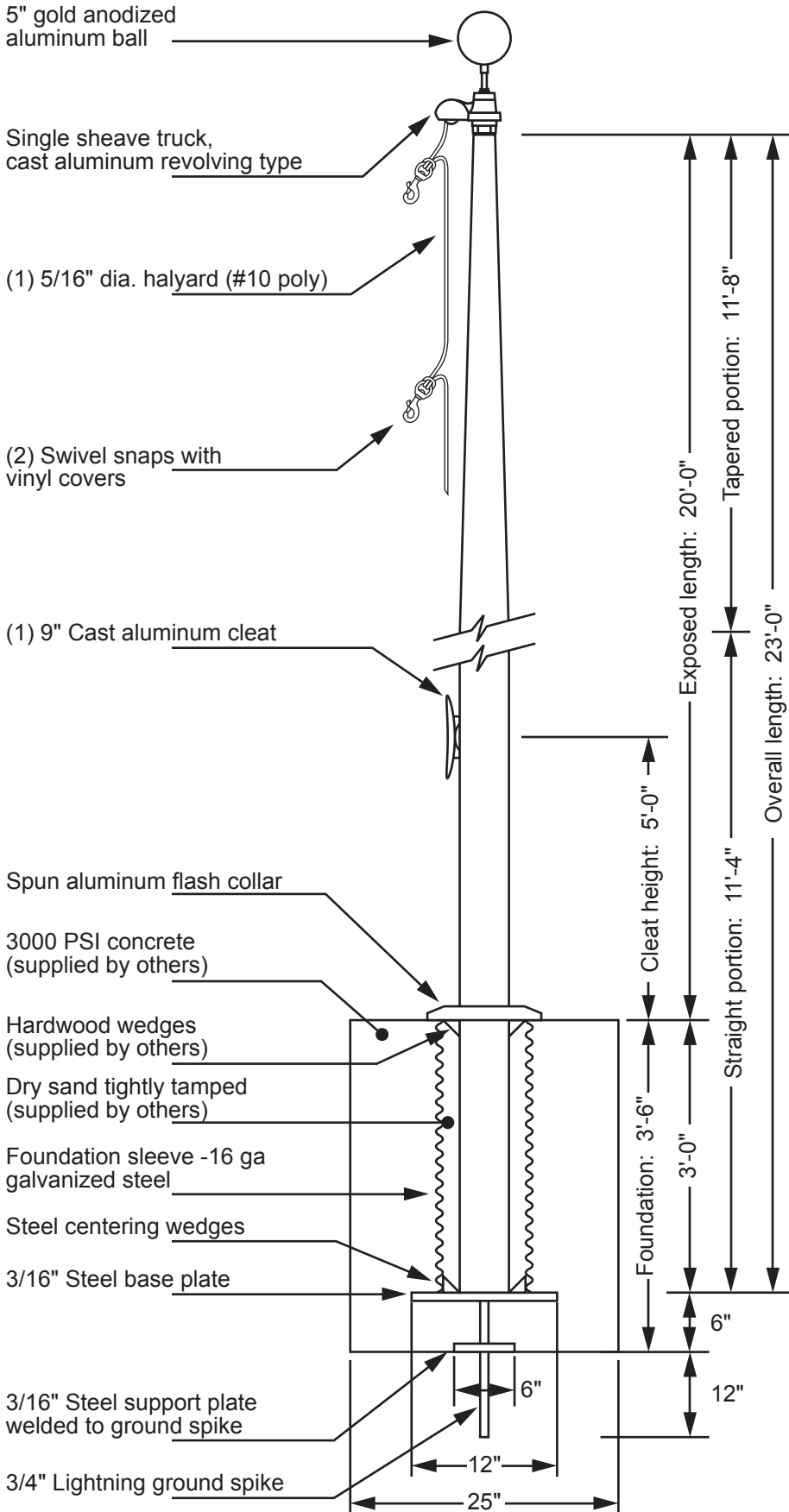

Single Sheave Truck Detail
 Revolving truck
 Cast aluminum body
 Stainless steel ball bearings
 Nylon sheave
 Cast aluminum spindle

Project: Location: Contractor: Customer:	Date: Job: Revision:	Exposed Height __ 20'-0" Overall Height __ 23'-0" Butt Diameter __ 5" Top Diameter __ 3" Wall Thickness __ .125" Ships in 1 section	Ground Set Tapered Aluminum Flagpole ALLOY 6063T6 80 grit polish FINISH:
			EDER FLAG 1000 W. Rawson Avenue Oak Creek, WI 53154 www.ederflag.com