



READYLIGHT

READYLIGHT GEN 2

INSTRUCTION MANUAL

DEAR FREESPIRIT FAMILY,

As a family owned and operated business, it is our hope that as you get out there and use the Freespirit products, you feel like a part of our extended family and also feel like we are all out there exploring this great planet *together.*

Our goal at Freespirit Recreation has always been to re-invent the roof top tent from the ground up and create amazing gear. We work hard to create the best designs using the best products that allow for a fast and easy set-up. We want you spending more time *exploring and enjoying life.*

You have asked us to be innovative, to provide the best quality, to provide great customer service, and to keep creating products that *Elevate Your Adventure* so stay in touch with us!

Follow us on social media and on our website, www.gofsr.com.

Have questions for us?

Reach out, we are here to help!

sales@gofsr.com

Oh, and because we have to put this in here...

**PLEASE REVIEW THIS INSTRUCTION MANUAL BEFORE USING
YOUR READYLIGHT GEN 2.**

From the Freespirit family to you, **THANK YOU for your purchase of the
Readylight Gen 2!**

We hope that it really will *Elevate Your Adventure!*

Renee Tewes: President and Team Leader, Customer Service

Tanner Tewes, Team Leader: Sales and Product Innovation

Kristine Sewell, Team Leader: Marketing

Ben Tewes, Team Leader: Sales and Product Innovation

TABLE OF CONTENTS:

PRODUCT OVERVIEW/VIDEO RESOURCES (PAGE 4)

PACKAGE CONTENTS (PAGE 5-6)

ASSEMBLY INSTRUCTIONS (PAGE 7-8)

MAIN PANEL INFO/CHARGING/OPERATION (PAGE 9-10)

PODLIGHTS OPERATION (PAGE 10-11)

PRODUCT SPECIFICATIONS (PAGE 12)

FREESPIRIT RECREATION CONTACT INFORMATION (PAGE 13)

PRODUCT OVERVIEW:

The next generation of ReadyLight is here! The Gen2 features a telescoping base so you can make it higher or lower, wider or slimmer to fit any space. The main light comes with 4 detachable white and amber colored Lightpods. Gen2 also comes with a compact, hard shell carrying case with foam inserts to keep the ReadyLight safe and secure when stored.

The Gen2 is the same high quality light as customers have come to expect from ReadyLight but with the new enhancements and improvements listed above. The ReadyLight has an extremely bright 550 lumens center light and 4 removable Light Pods which replace the need for flashlights, lanterns, work lights, strobe lights—you name it. Offering up to 30-hours of light, the powerful lithium batteries can be charged 3 different ways—solar, AC & DC. Plus, it's a USB charging station for your mobile devices. We like to think of it as the most versatile backyard to back country light ever designed.

Available in Black Ops and Desert Sand.

VIDEO RESOURCES:

READYLIGHT TIPS AND TRICKS

BY: FREESPIRIT RECREATION

SOURCE: YOUTUBE

https://www.youtube.com/watch?v=KLAz_J1sGDA

YOU WILL NEVER BUY ANOTHER CAMP LIGHT AGAIN

THE FSR GEN 2 READYLIGHT

BY: BAPTISM OVERLAND

SOURCE: YOUTUBE

<https://www.youtube.com/watch?v=EsCIsABlcXQ>

PACKAGE CONTENTS:

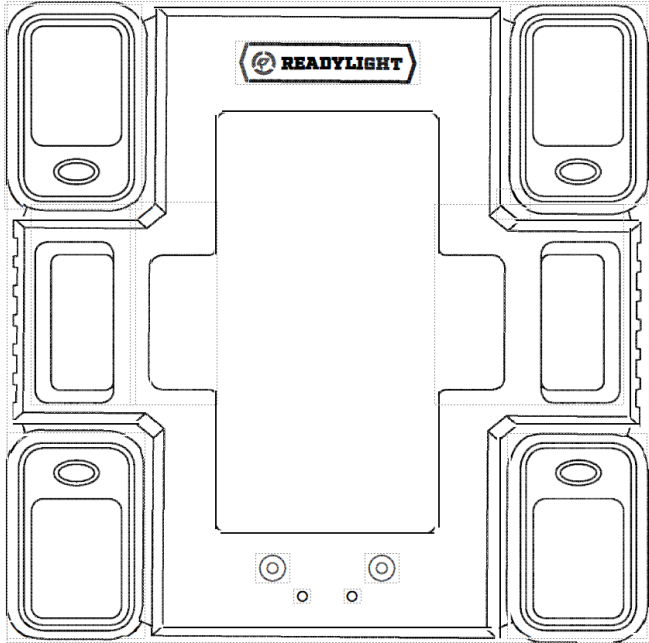

READYLIGHT HEAD

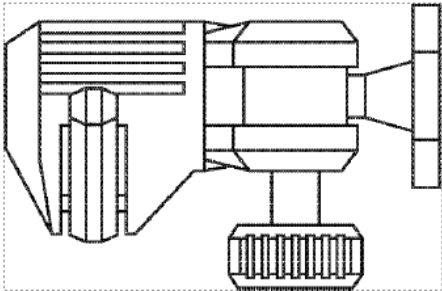

TRIPOD SWIVEL CLAMP

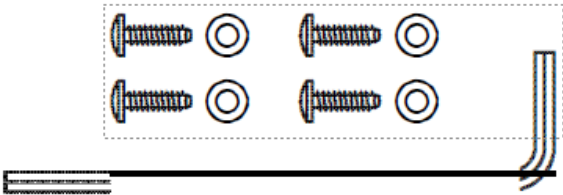

**FASTENERS, LOCK
WASHERS, HEX-KEY
WRENCH**

**2 FASTENERS REQUIRED; 2
EXTRAS ARE PROVIDED**



TELESCOPING TRIPOD LEGS

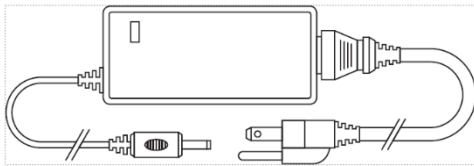

AC POWER ADAPTER

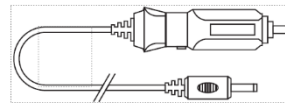

DC POWER ADAPTER/ CAR CHARGER

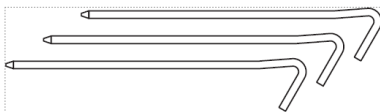

GROUND STAKES



HARD SHELL CARRYING CASE

ASSEMBLY INSTRUCTIONS:

1. Remove all parts from the hard shell carrying case.

2. Screw all three legs into the center hub to make the tri-pod base.



3. Assemble the Readylight head.

a. Using two of the supplied fasteners, two lock washers, and the hex key wrench, secure tripod swivel clamp to ReadyLight head as shown.

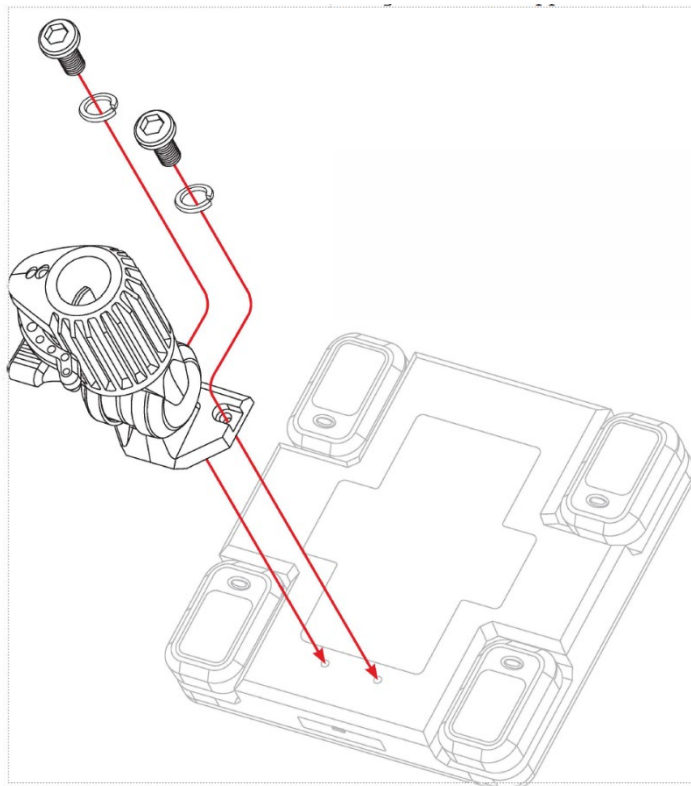

b. Release locking lever on swivel clamp ...

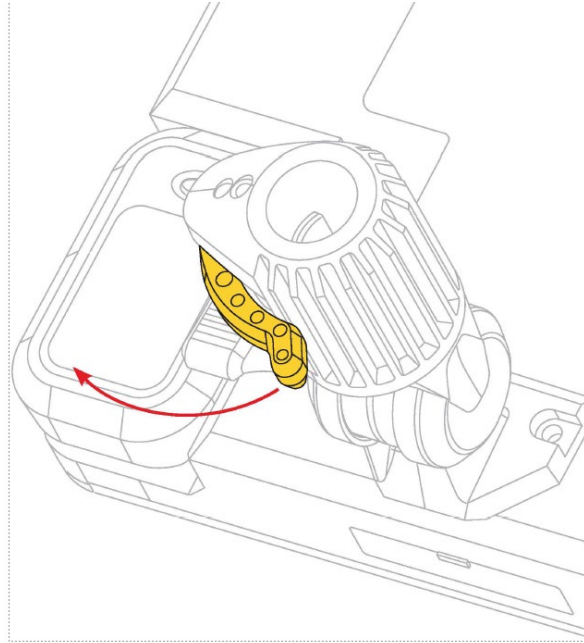

c.

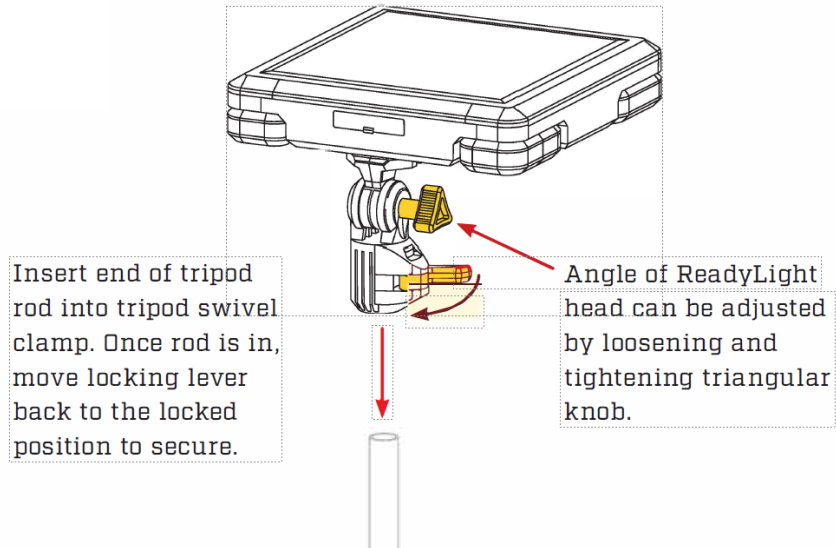

MAIN PANEL:

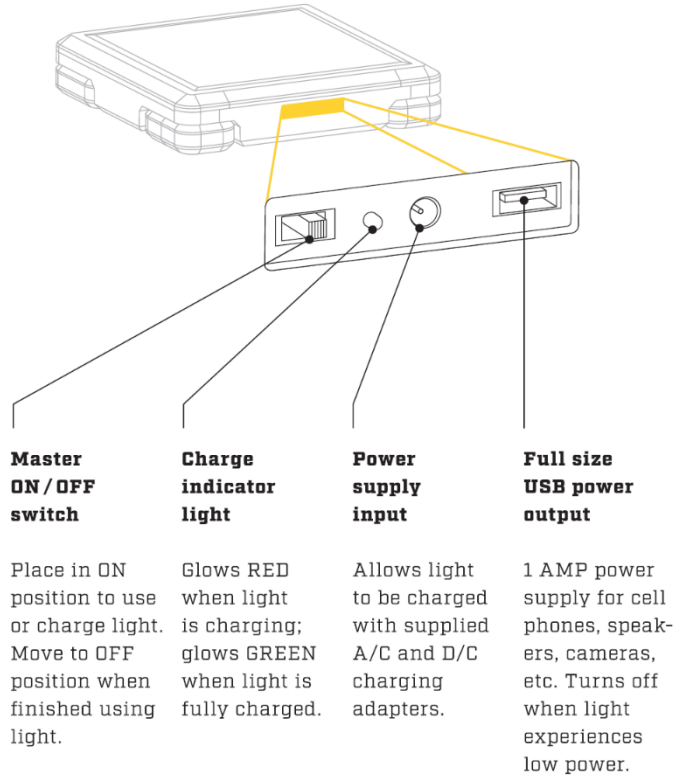

CHARGING:

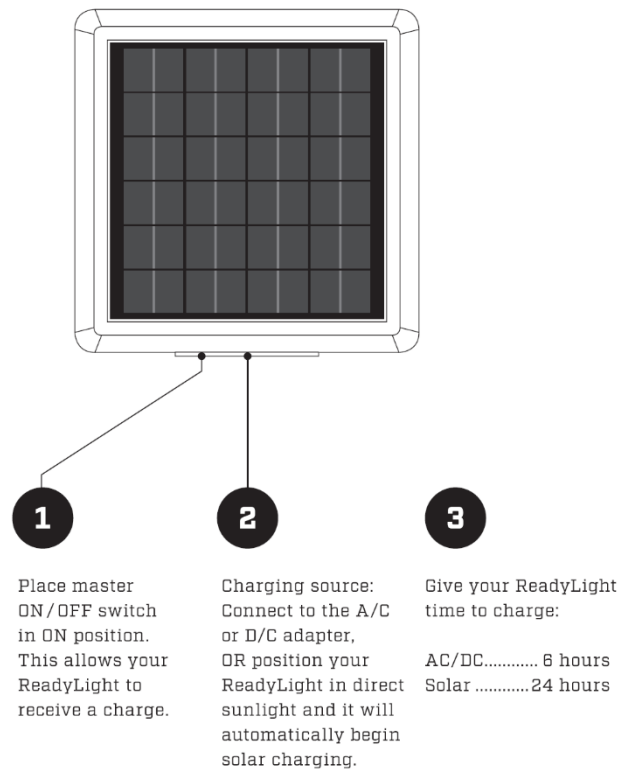

MAIN LIGHT OPERATION:

1

Turn on light:
Press and hold ON/OFF button for 1-2 seconds...
...lights will first activate at their brightest (5 WATT) setting.

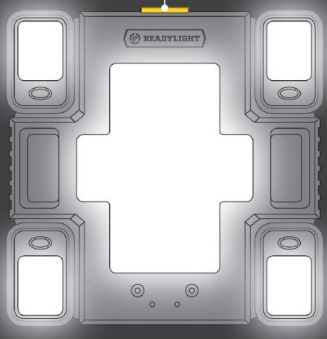

2

Momentarily depress ON/OFF button a second time:
Lights will dim to their low (2.5 WATT) setting.

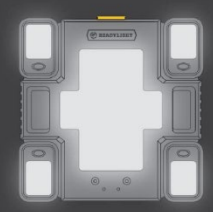

3

Momentarily depress ON/OFF button a third time:
Main lights will deactivate and red warning lights will turn on and blink slowly.

To repeat the cycle of light functions, continue to depress the ON/OFF button.

Press and hold ON/OFF button to turn off light.

Red indicator lights will flash quickly when batteries are low on power.

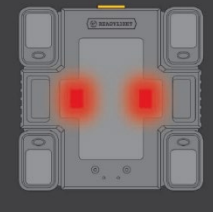

PODLIGHTS:

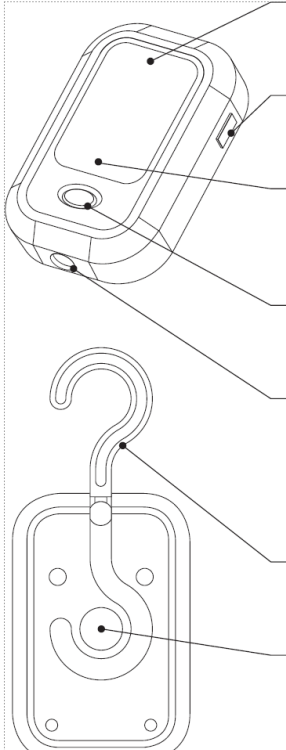

Charge indicator light
Hidden under main lens.
Lights red when charging.

Mini USB charging port
Allows for charging of light independent of main light.

Low power indicator light
Hidden under main lens.
When charging is required, light turns red.

ON/OFF switch
Press and hold 1-2 seconds to turn on light.

LED spot light

Fold-out hook
Lets you hang your light just about anywhere.

Powerful base magnet
Firmly secures light to main ReadyLight. Also allows light to adhere to any ferrous metal surface.

PODLIGHTS OPERATION:

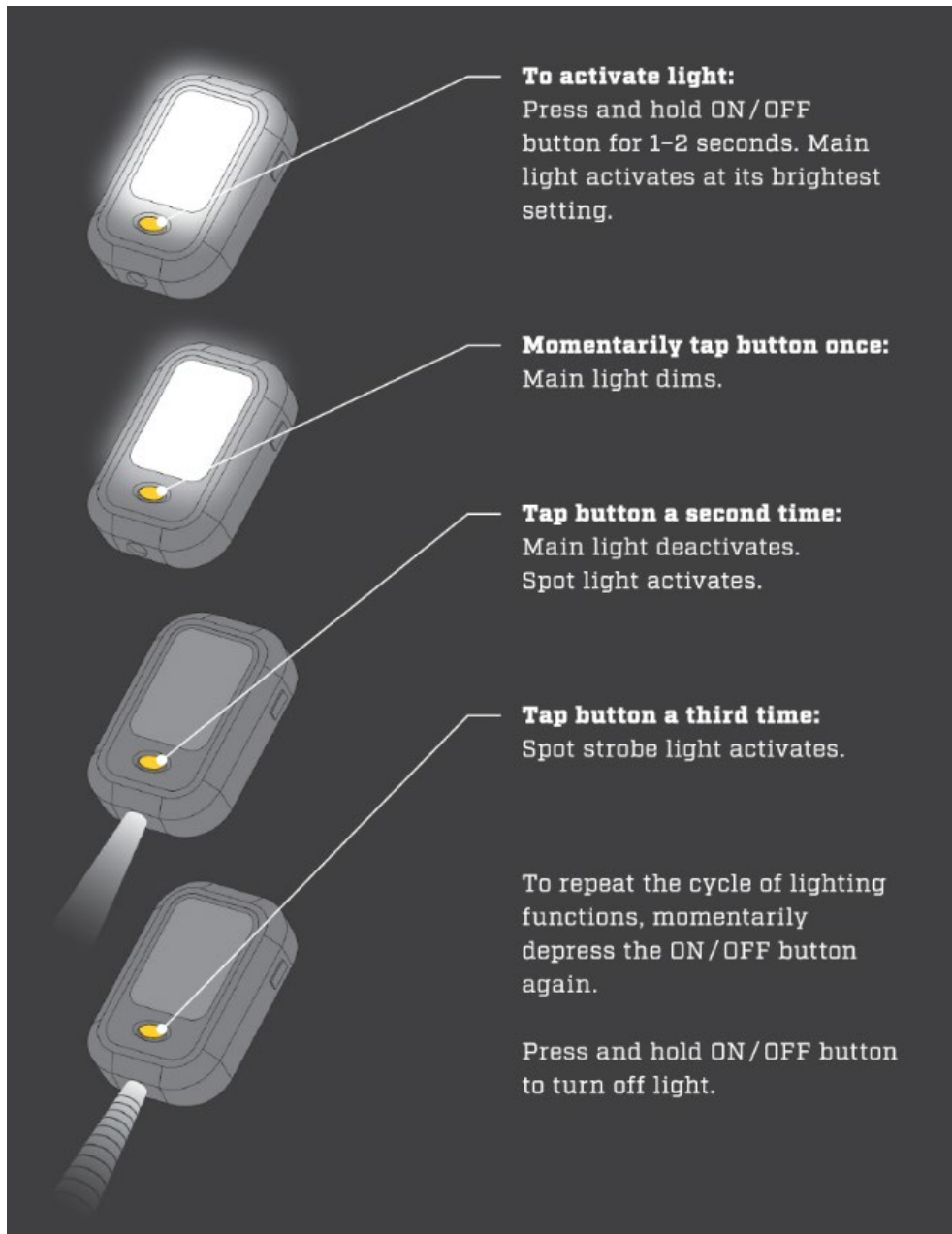

SPECIFICATIONS:

MAIN LIGHT

BATTERY TYPE.....	Lithium-Ion
BATTERY CAPACITY.....	7.4V 7800mAh
DC POWER.....	12V CLA charger
AC/DC CHARGE TIME	6 hours
SOLAR CHARGE TIME.....	up to 24 hours
RUN TIME	15 hours / 30 hours
MAXIMUM POWER	15W
BRIGHTNESS SETTINGS	5W / 2.5W
LUMENS.....	350lm / 175lm
CHARGING TEMPERATURE, CELSIUS.....	0°–50°
DISCHARGE TEMPERATURE, CELSIUS.....	-20°–50°
EXTERNAL USB POWER SUPPLY.....	5V 1A

PORTABLE LIGHTS

BATTERY TYPE.....	Lithium-Ion
BATTERY CAPACITY.....	3.7V 1800mAh
WATTAGE, SINGLE UNIT	1W
WATTAGE, ALL 4 UNITS.....	4W
LUMENS, SINGLE UNIT	80lm
LUMENS, ALL 4 UNITS.....	320lm
RUN TIME, SINGLE UNIT.....	8 hours
CHARGE TIME	8 hours
WORKING TEMPERATURE, CELSIUS	-20°–60°

TOTAL LIGHT SPECIFICATIONS

LUMENS.....	500lm
RENDERING INDEX.....	Ra80
CCT	6500K
SERVICE LIFE.....	20,000 hours
WORKING HUMIDITY	≤ 95%
SHELL MATERIAL	Flame-retardant ABS
INGRESS PROTECTION	IP63



**Freespirit Denver
120 Capital Drive
Golden, CO 80410**

**Freespirit Bend
2453 NE 4th Street Suite 110
Bend, OR 97701**

WWW.GOFSR.COM

Have Questions? Please reach out to sales@gofsr.com.

#gofsr