

MB5526-03
Qty: 1

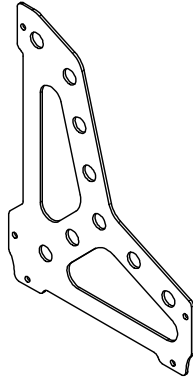

MB5526-02_MIR
Qty: 1

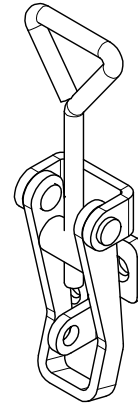

TOGGLE CLAMP
Qty: 1

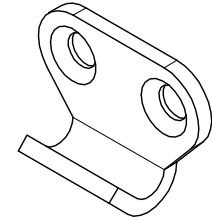

**TOGGLE CLAMP
KEEPER**
Qty: 1

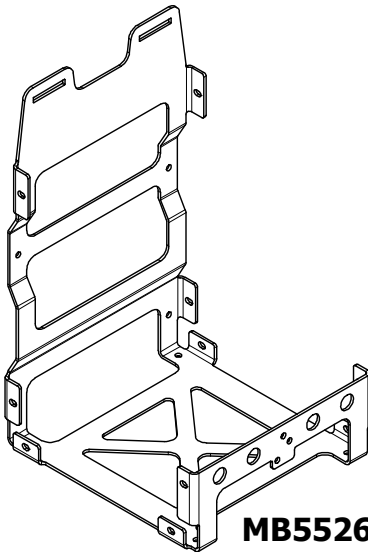

MB5526-01
Qty: 1

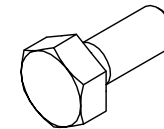

HEX BOLT
1/4"-20 x 5/8" GR 8
Qty: 10

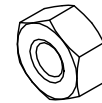

NYLOCK THIN NUT
1/4"-20
Qty: 10

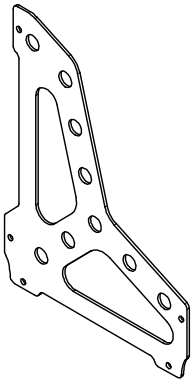

MB5526-02
Qty: 1



**COUNTER SUNK
MACHINE SCREW**
#10-24 x 1/2"
Qty: 5



MACHINE NUT
#8-32
Qty: 5



Dwg/Part No:
MB5526 - Shipping
Description:
VP Gas Can Mount

Sheet No: **1** of **1**
Rev No: **0**

Mat'l: