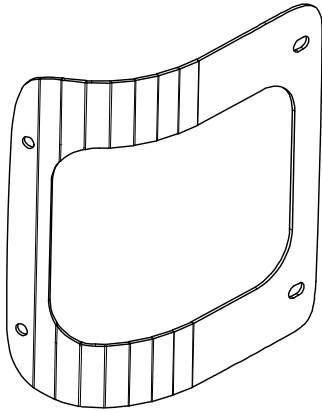
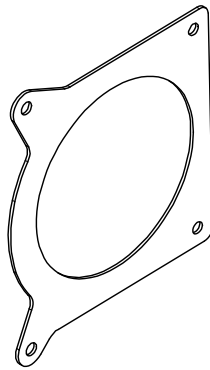
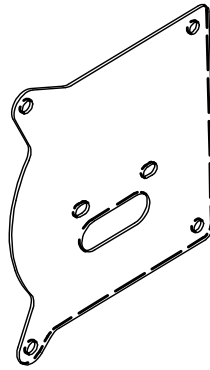
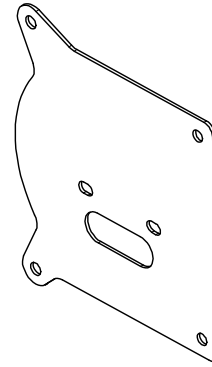
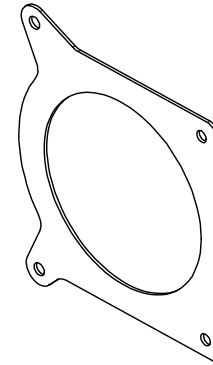
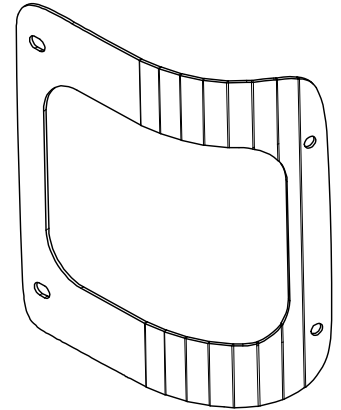
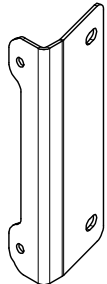
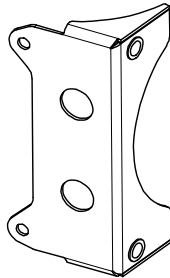
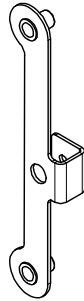
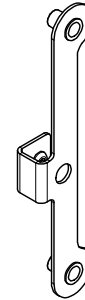
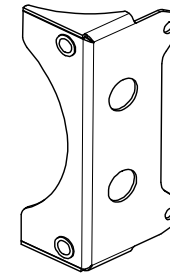
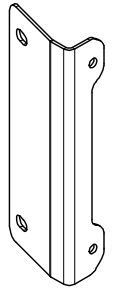
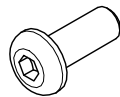

DRIVERS SIDE

PASSENGER SIDE

**MB5521-01\_MIR**  
Qty 1

**MB5521-03\_MIR**  
Qty 1

**MB5521-06\_MIR**  
Qty 1

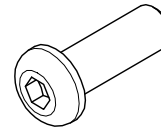
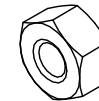
**MB5521-06**  
Qty 1

**MB5521-03**  
Qty 1

**MB5521-01**  
Qty 1

**MB5521-02\_MIR**  
Qty 1

**MB5521-04\_MIR**  
Qty 1

**MB5521-05\_MIR**  
Qty 1

**MB5521-05**  
Qty 1

**MB5521-04**  
Qty 1

**MB5521-02**  
Qty 1

FASTENERS

**HEX BUTTON HEAD SCREW**  
#10-24 x 1/2" S.S.  
Qty 6

**NYLOCK NUT**  
#10-24 S.S.  
Qty 6

**HEX BUTTON HEAD SCREW**  
1/4"-20 x 3/4" S.S.  
Qty 12

**NYLOCK NUT**  
1/4"-20 S.S.  
Qty 4

Dwg/Part No:

**MB5521 - Shipping**

Description:

**JL Round Taillight Conversion Kit**

Mat'l:

Sheet No: 1 of 1

Rev No: 0