

MB5040 - TANK
Qty: 1

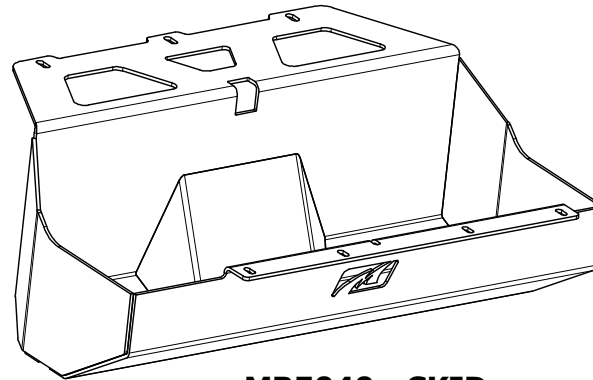

MB5040 - SKID
Qty: 1

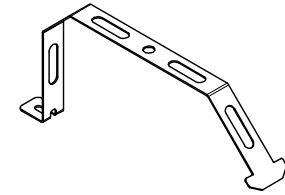

**MB5040-09
TANK STRAP**
Qty: 1

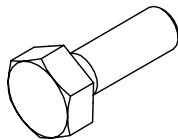

HEX BOLT
1/4\"-20 x 3/4\"
Qty: 6



LOCK WASHER
1/4\"
Qty: 6



FLAT WASHER
1/4\"
Qty: 6

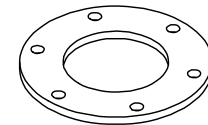

**MB5527-02
FUEL PUMP CLAMPING RING**
Qty: 1

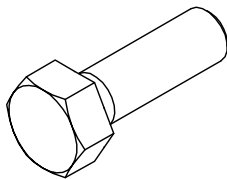

HEX BOLT
5/16\"-18 x 1\"
Qty: 1

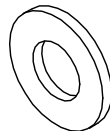

FLAT WASHER
5/16\"
Qty: 2

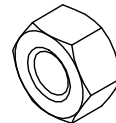

NYLOCK NUT
5/16\"-18
Qty: 1

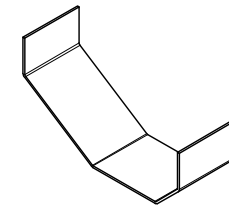

MB5040 - RUBBER STRIP
18\" x 4\"
Qty: 2



Dwg/Part No:

MB5040 - Shipping

Description:

CJ-7 Stretch Fuel Tank and SkidSheet No: **1** of **1**Rev No: **0**

Mat'l: