

MB1218 - Shipping Crusher Rear Bumper

CONTENTS

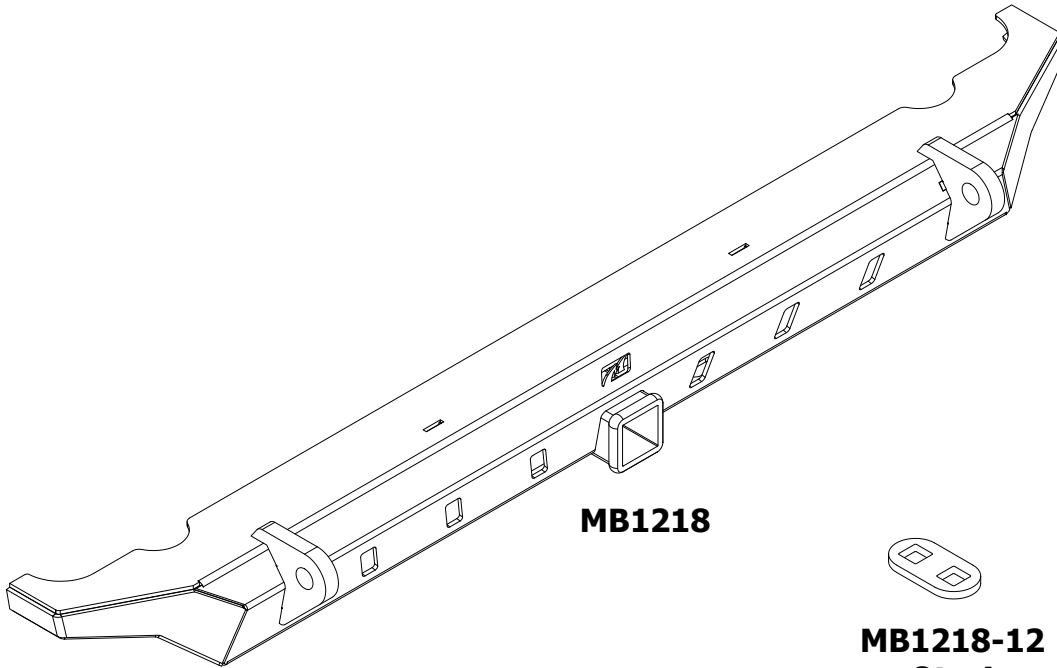

MB1218

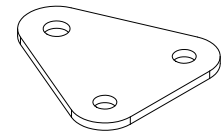

MB1218-11
Qty 2

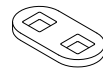

MB1218-12
Qty 4

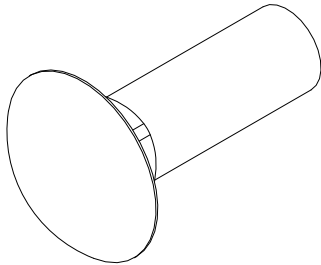

1/2"-13 x 1.5" Carriage Bolt
Qty 8

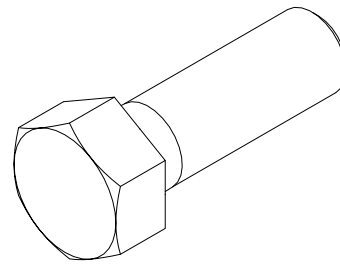

1/2"-13 x 1.5" Hex Bolt
Qty 6

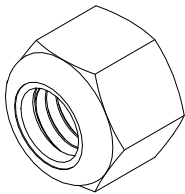

1/2"-13 Lock Nut
Qty 12



1/2" Push-Nut
Qty 8

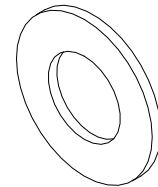

1/2" Plain Washer
Qty 18