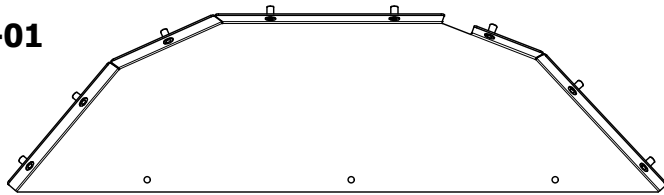
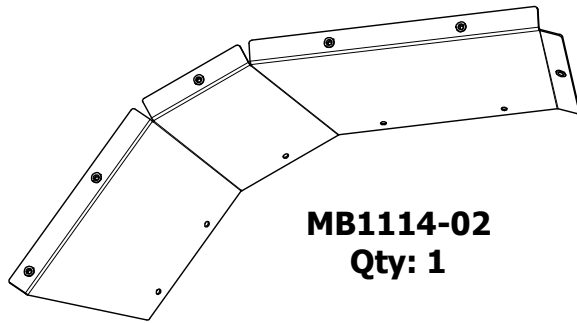
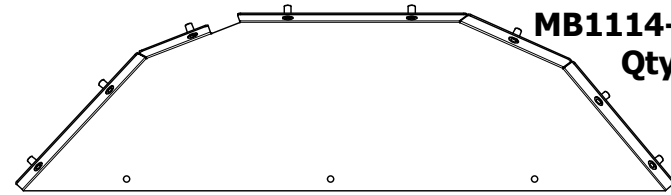
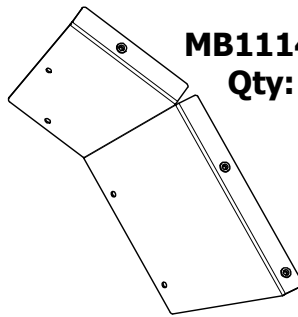
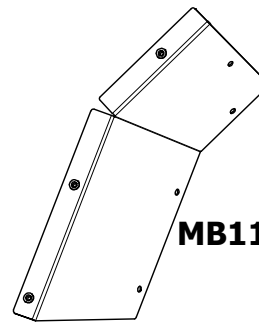
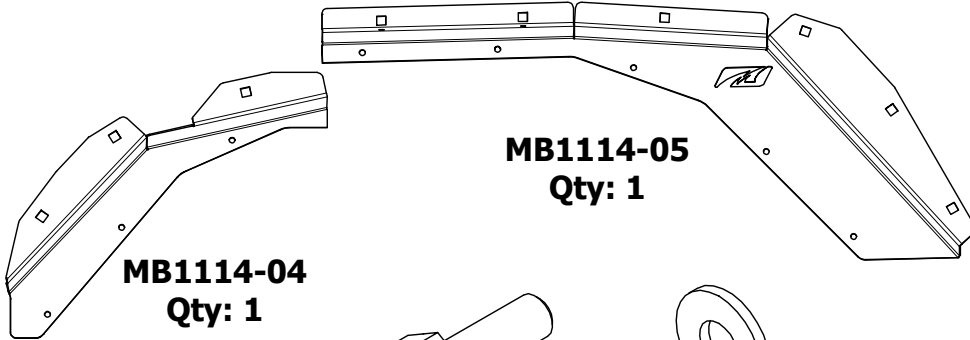
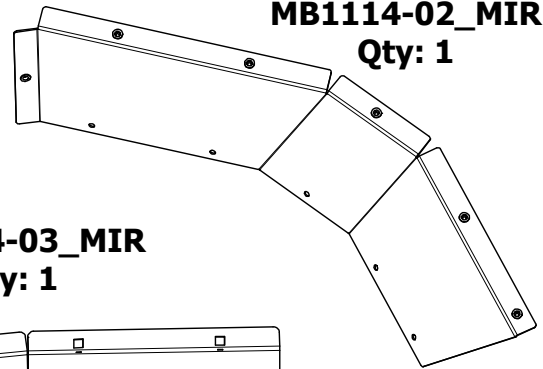
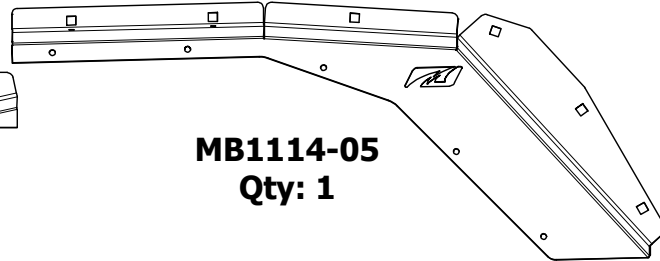
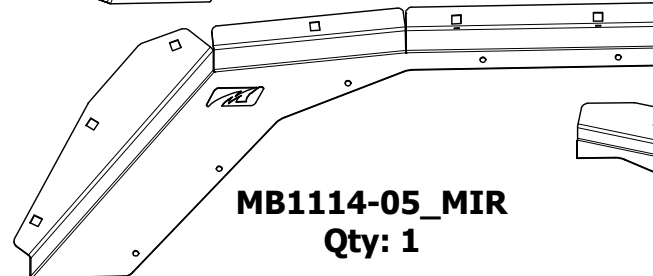
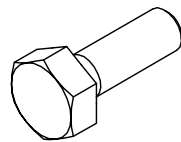
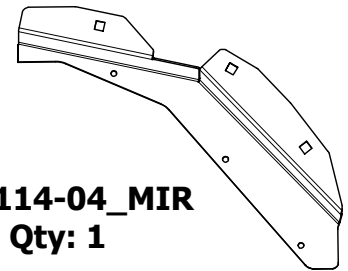

DRIVER

PASSENGER

**MB1114-01**  
 Qty: 1

**MB1114-01\_MIR**  
 Qty: 1

**MB1114-02**  
 Qty: 1

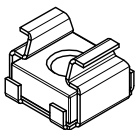
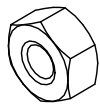
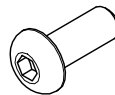
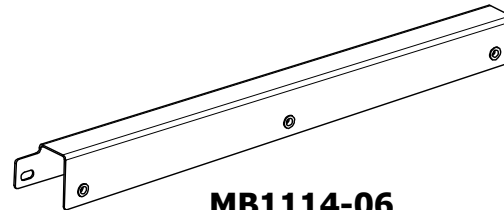
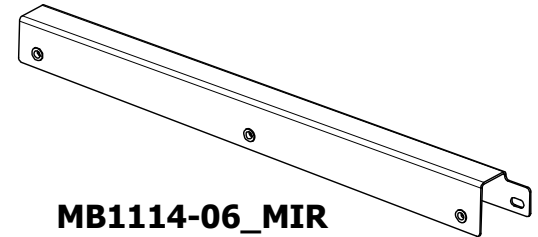
**MB1114-03**  
 Qty: 1

**MB1114-02\_MIR**  
 Qty: 1

**MB1114-03\_MIR**  
 Qty: 1

**MB1114-04**  
 Qty: 1

**MB1114-05**  
 Qty: 1

**MB1114-05\_MIR**  
 Qty: 1

**MB1114-04\_MIR**  
 Qty: 1

**HEX BOLT**  
 1/4"-20 x 3/4"  
 Qty: 22

**FLAT WASHER**  
 1/4"  
 Qty: 8

**CAGE NUT**  
 1/4"-20  
 Qty: 18

**NYLOCK NUT**  
 1/4"-20  
 Qty: 4

**BUTTON HEAD SCREW**  
 #10-24 x 1/2"  
 Qty: 40

**MB1114-06**  
 Qty: 1

**MB1114-06\_MIR**  
 Qty: 1

Dwg/Part No:

**MB1114 - Shipping**

Description:

**Rear Inner Fender - JT**

Sheet No: 1 of 1

Rev No: 0

Mat'l: