

MB1101 - PASSENGER
Qty: 1

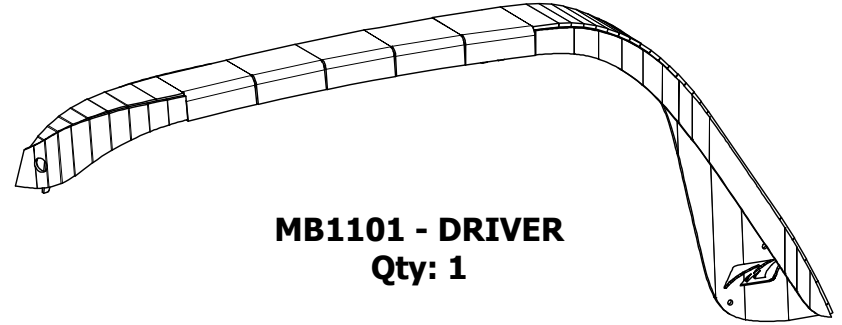

MB1101 - DRIVER
Qty: 1

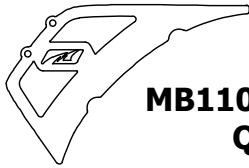

MB1101-09_MIR
Qty: 1

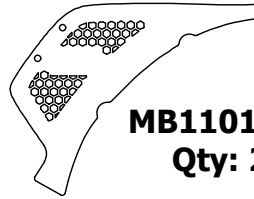

MB1101-08
Qty: 2

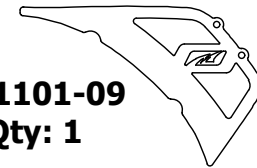

MB1101-09
Qty: 1

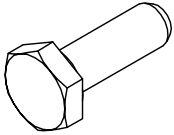

HEX BOLT
1/4"-20 x 3/4"
Qty: 6

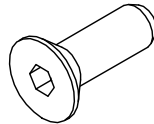

COUNTER SUNK BOLT
1/4"-20 x 3/4"
Qty: 4

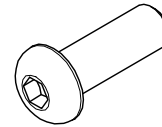

BUTTON HEAD SCREW
1/4"-20 x 3/4"
Qty: 4

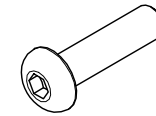

BUTTON HEAD SCREW
#10-24 x 3/4"
Qty: 4

3/4" CLEAR LENS LED
FENDER/SIDE
MARKER LIGHT
2 PACK

MB6500
Qty: 1

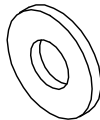

FLAT WASHER
1/4"
Qty: 16



NYLOCK NUT
1/4"-20
Qty: 10

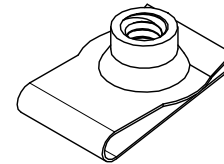

BARREL NUT
1/4"-20
Qty: 4

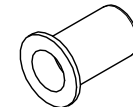

RIVNUT
#10-24
Qty: 4



Dwg/Part No:

MB1101 - Shipping

Description:

Front Fenders - JL/JLU/JT

Mat'l:

Sheet No: 1 of 1

Rev No: 0