

IMANIX[®]
by Braintoys



DESCARGABLES
IMANIX
DESCARGABLES

DESCARGABLE

El juego de replicar

A stylized illustration of a hand holding a white paper strip with a black border. The strip contains the text 'El juego de replicar'. A soccer ball icon is positioned on the right side of the strip. The hand is drawn with yellow outlines, and there are blue and yellow abstract shapes in the background.

LÁMINAS QUE ESTIMULAN
LA HABILIDAD VISUAL

imanix.com



**Desafío nivel
principiante**

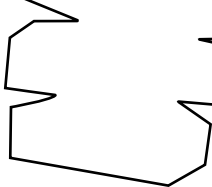

Un barco

puede flotar y desplazarse en el agua. Los barcos **navegan** por los mares. Existen diferentes tipos de embarcaciones. Según su tamaño, número de velas y otras características, reciben su nombre.

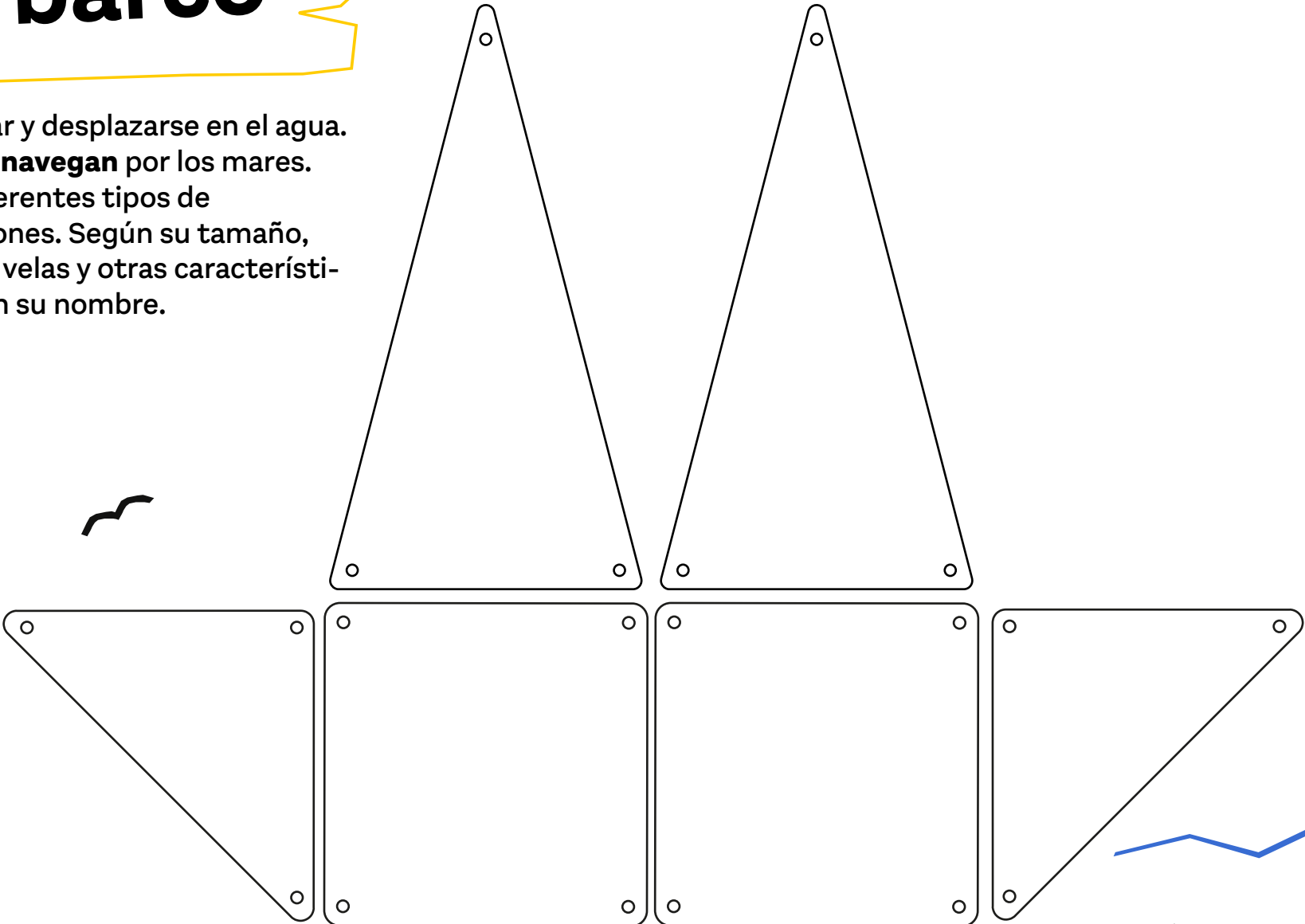

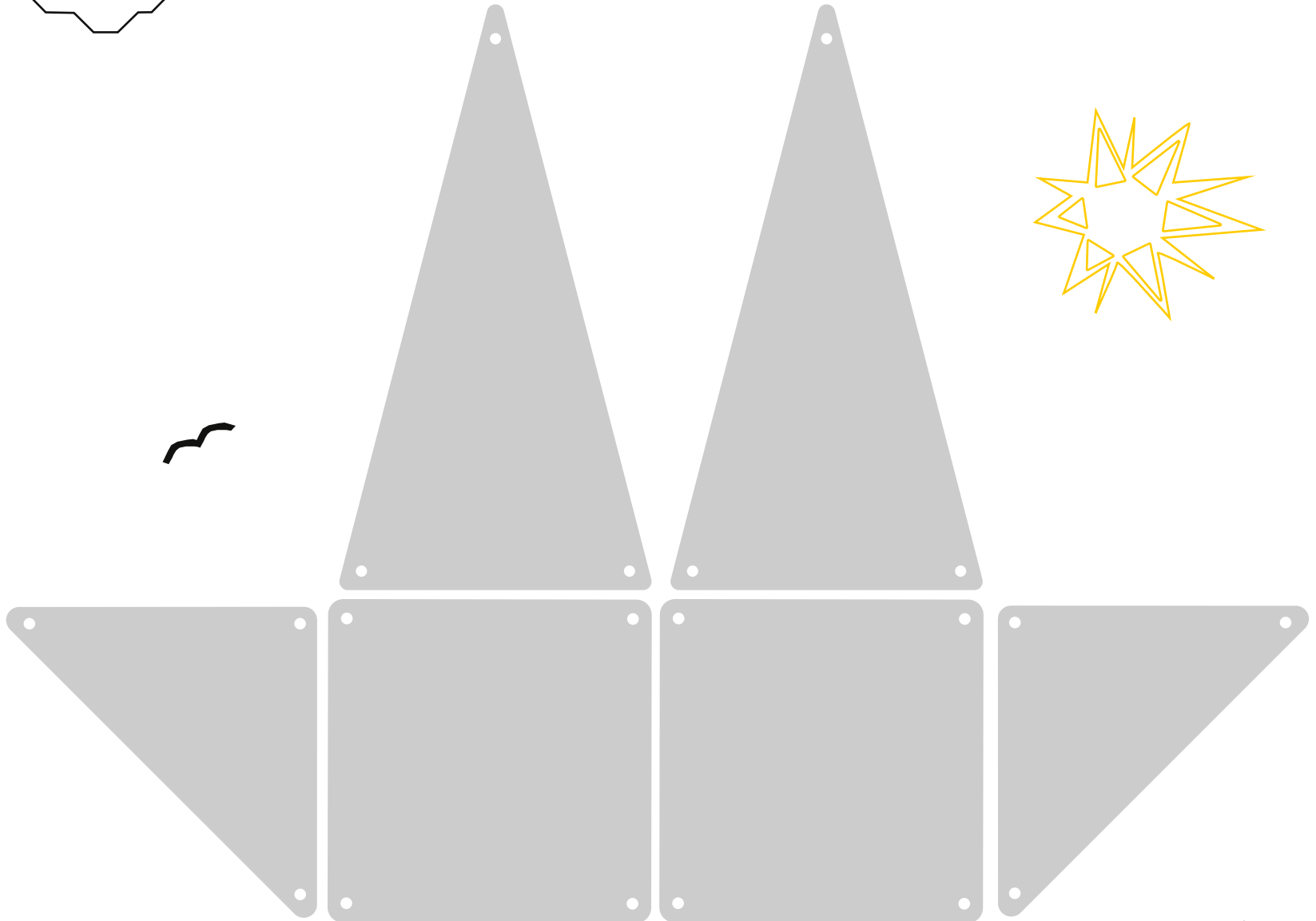
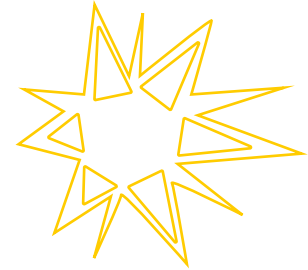
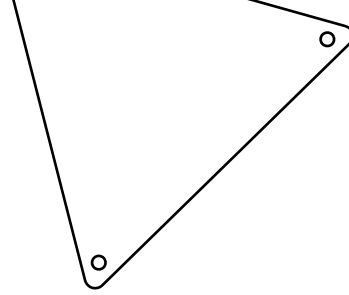
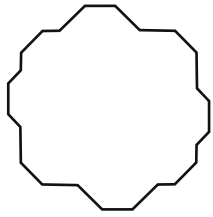

imanix.com

IMANIX[®]
by Braintoyz

El astillero

es el lugar donde se construyen y arreglan los barcos. Los astilleros se construyen cerca del mar o de ríos navegables, para permitir el acceso de las embarcaciones.

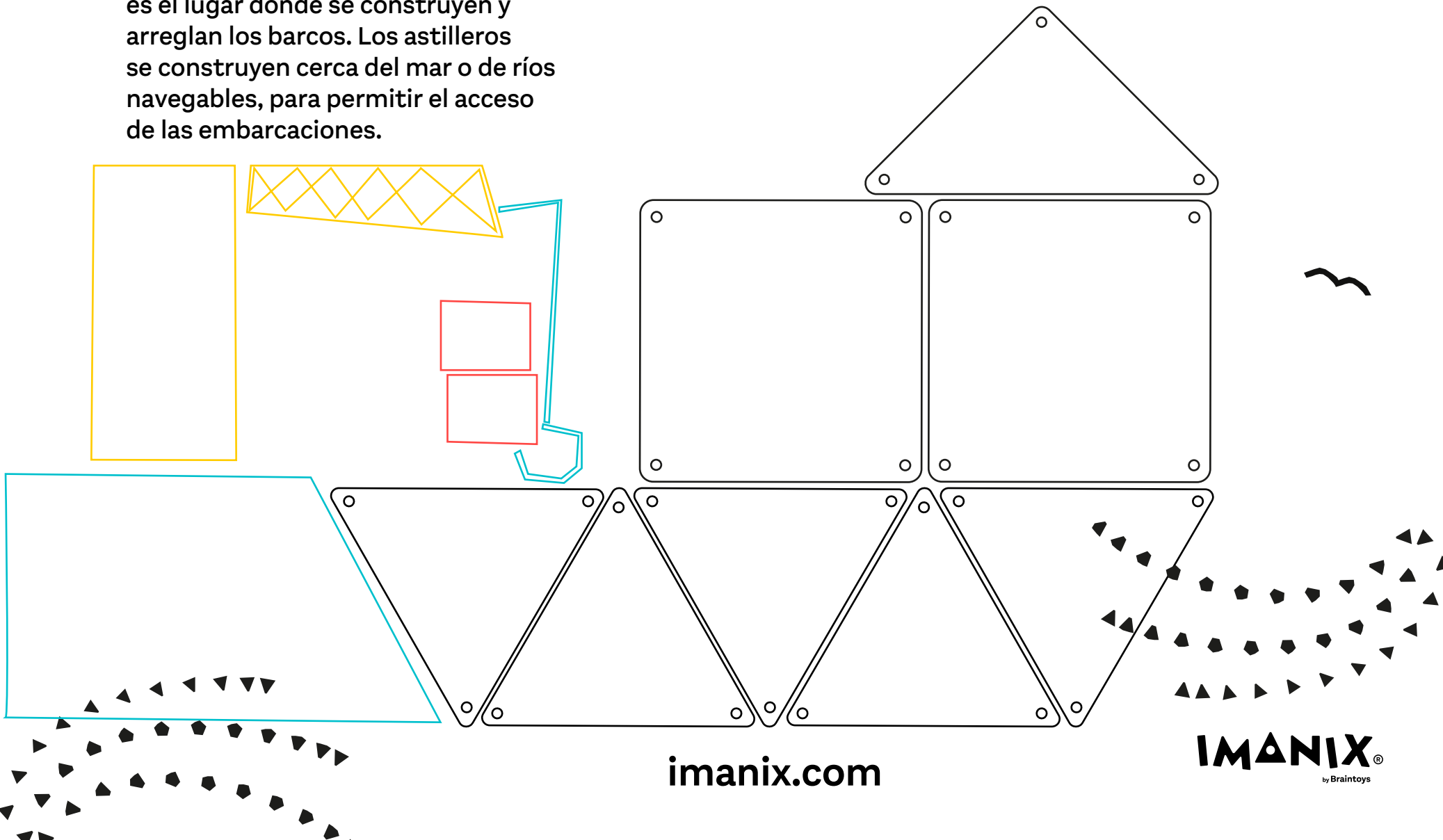

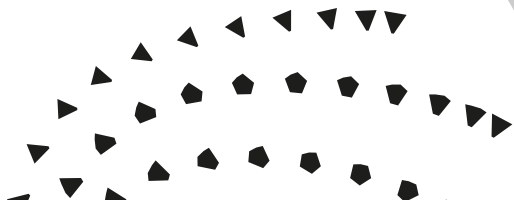
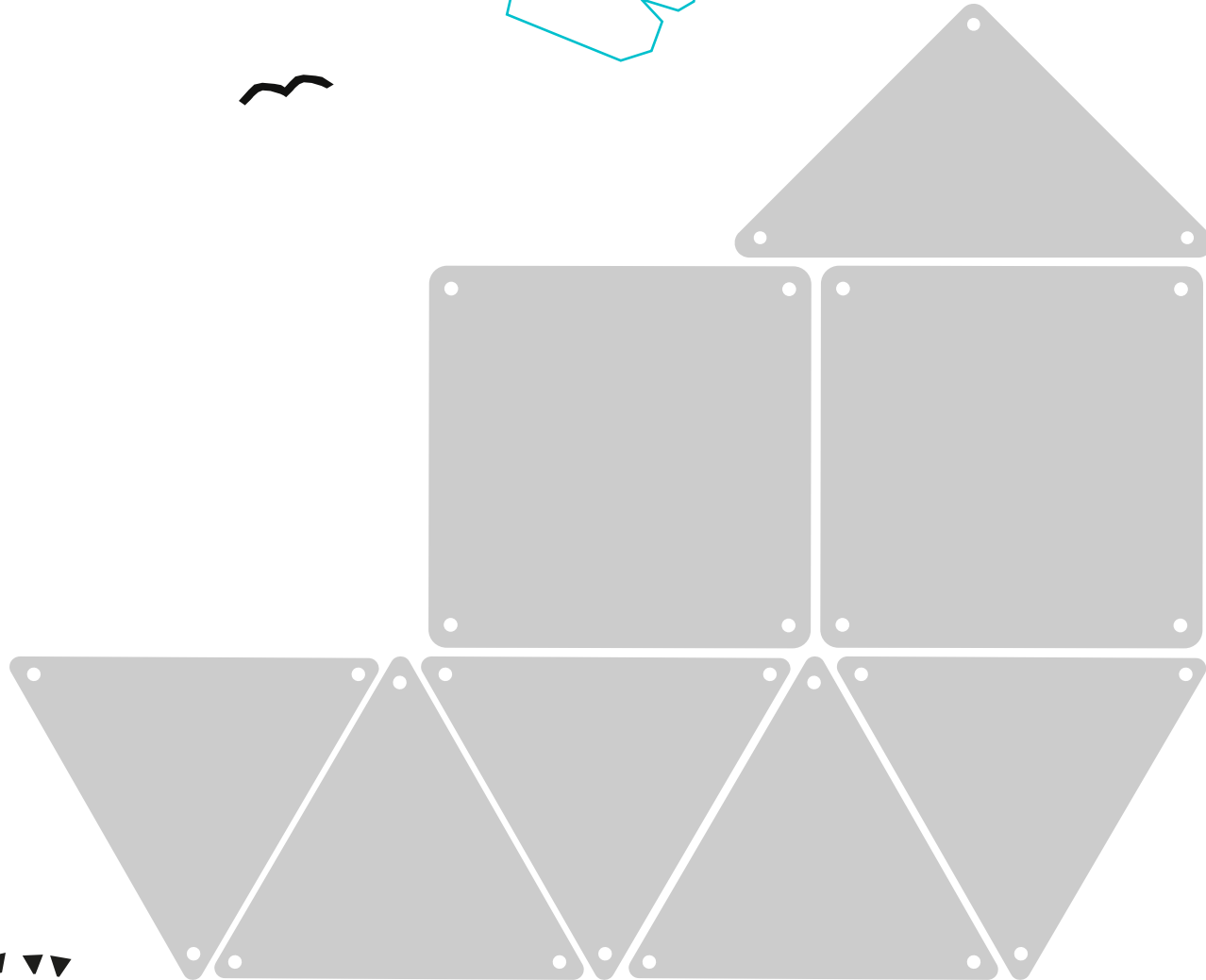
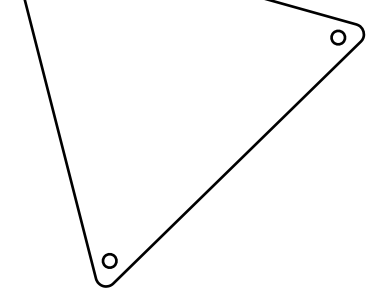
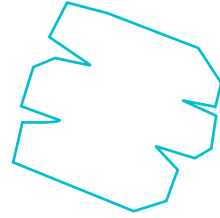
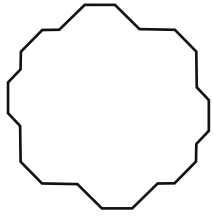

imanix.com

IMANIX[®]
by Braintoyz

Timón

Los **barcos** tienen un timón que le permite a los navegantes **maniobrar** y dirigir el barco hacia cualquier dirección.

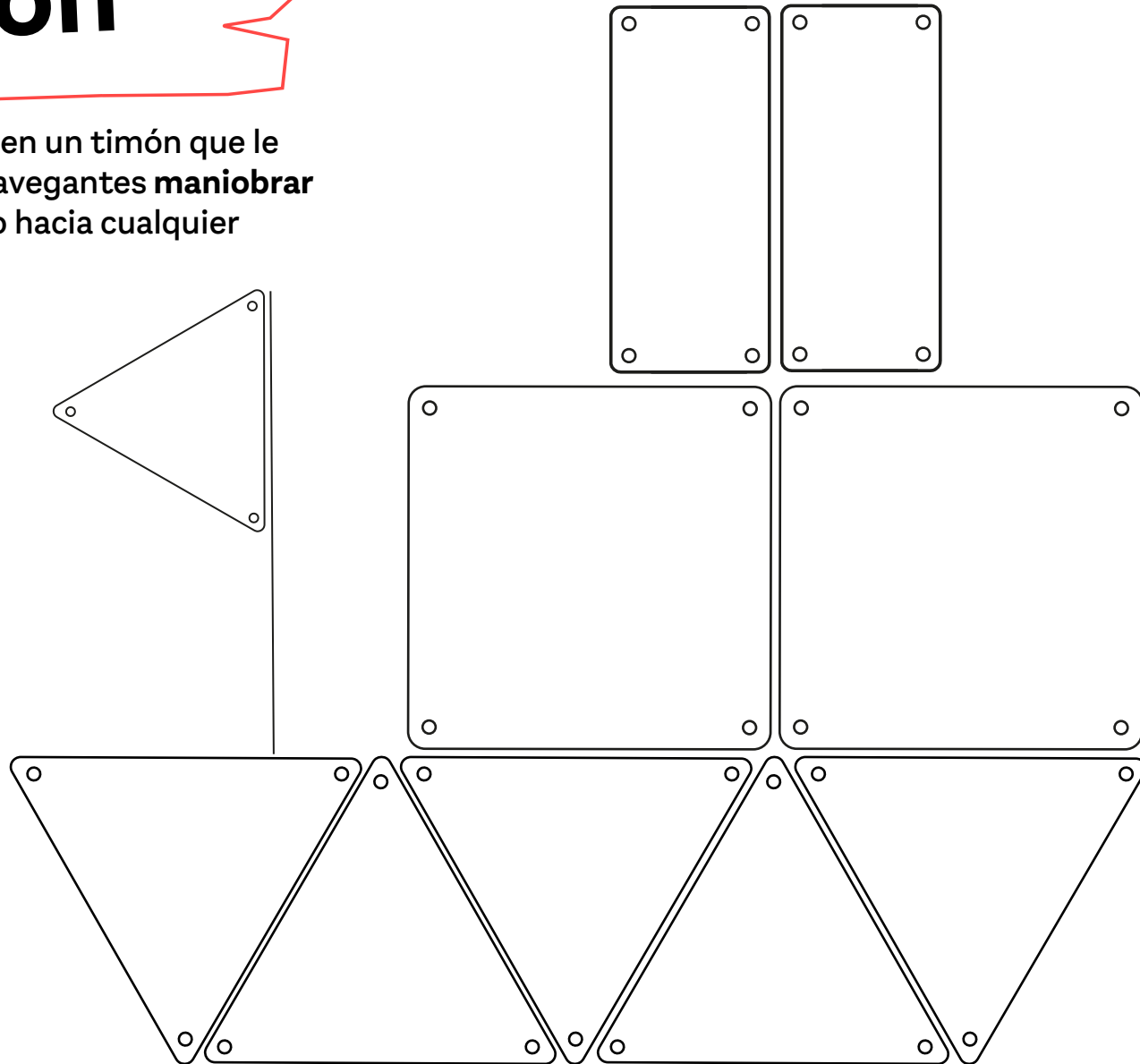

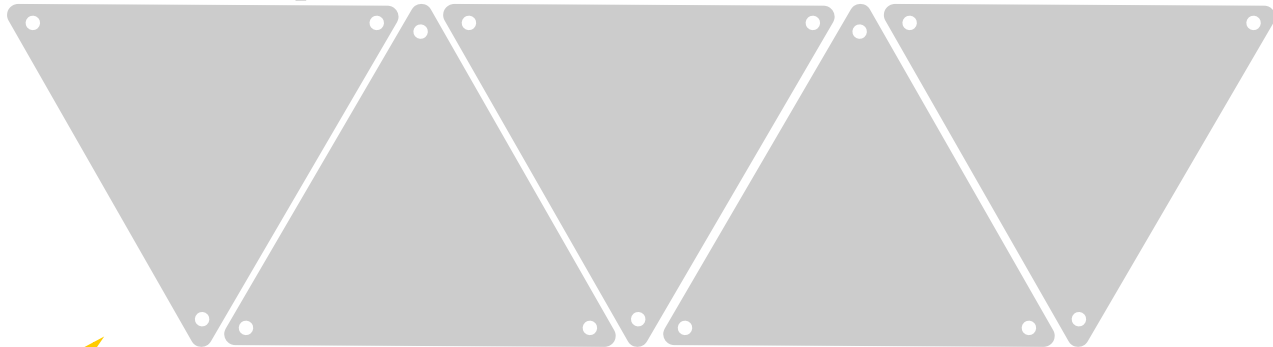
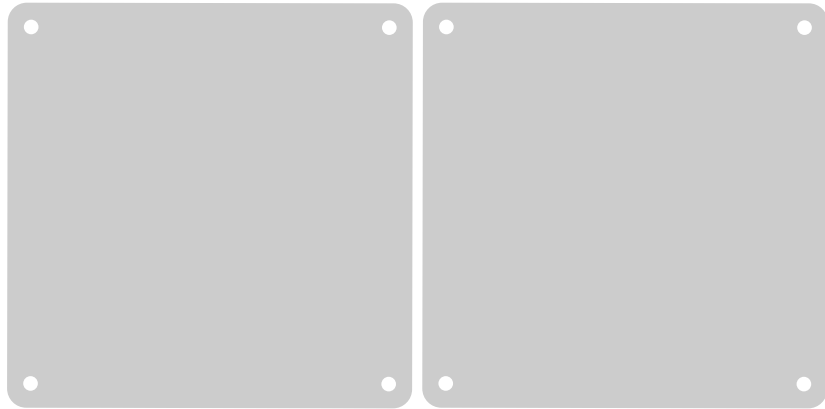
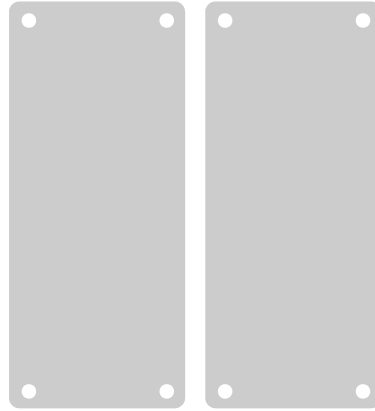
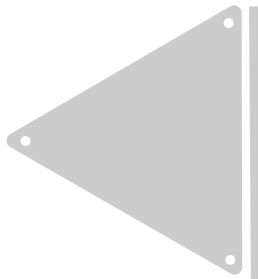
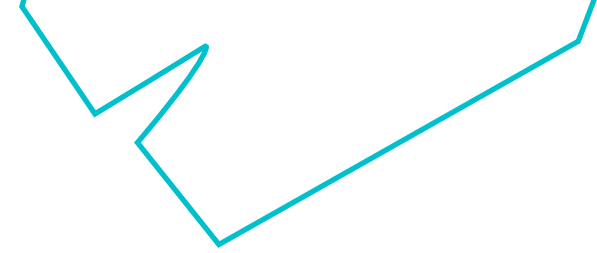
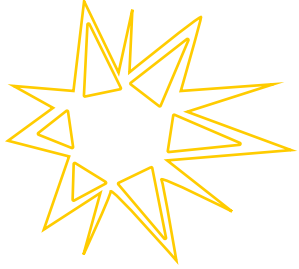

imanix.com

IMANIX[®]
by BrainToys



Las velas

de una embarcación son, generalmente de tela o de un material plástico. Son muy importantes ya que permiten, junto con el viento, que la embarcación **pueda avanzar**.

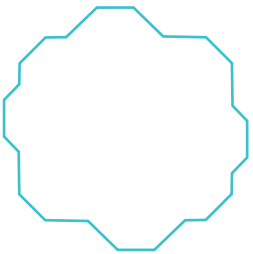
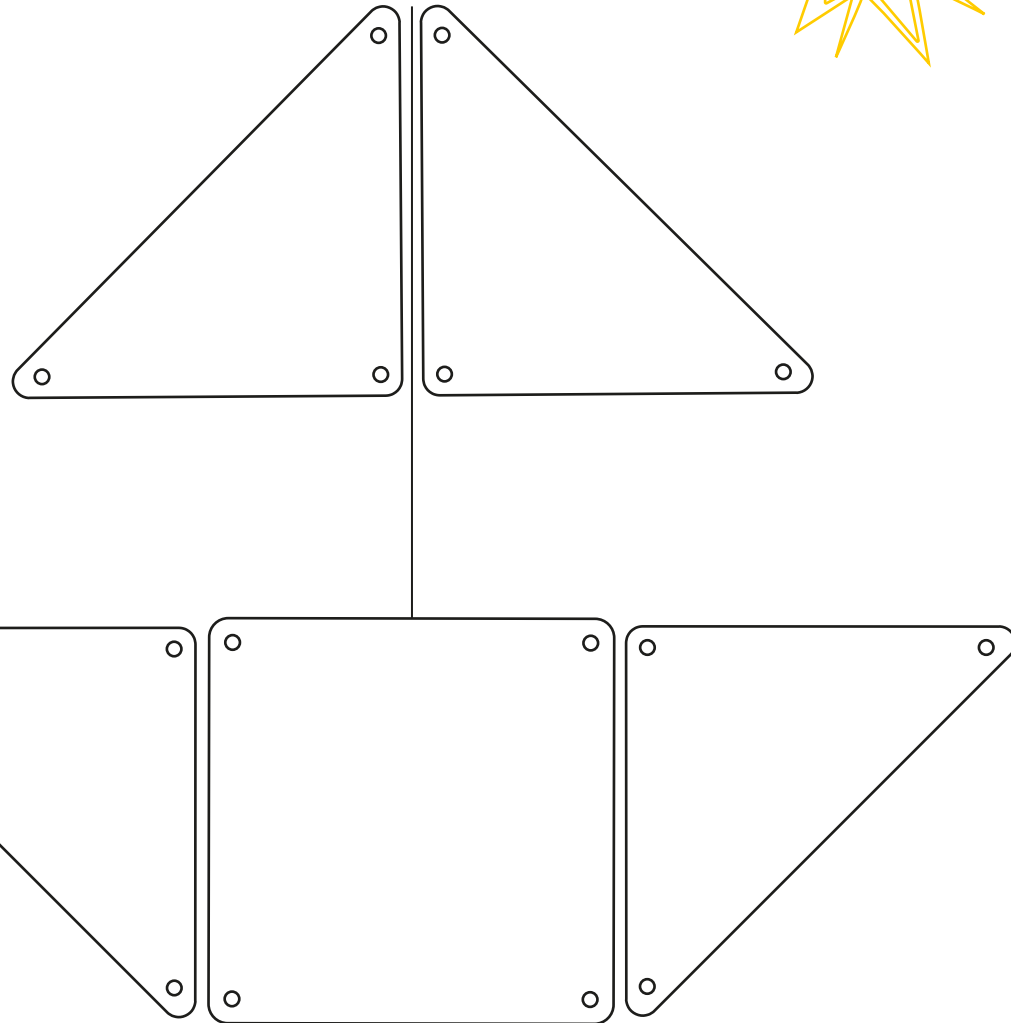

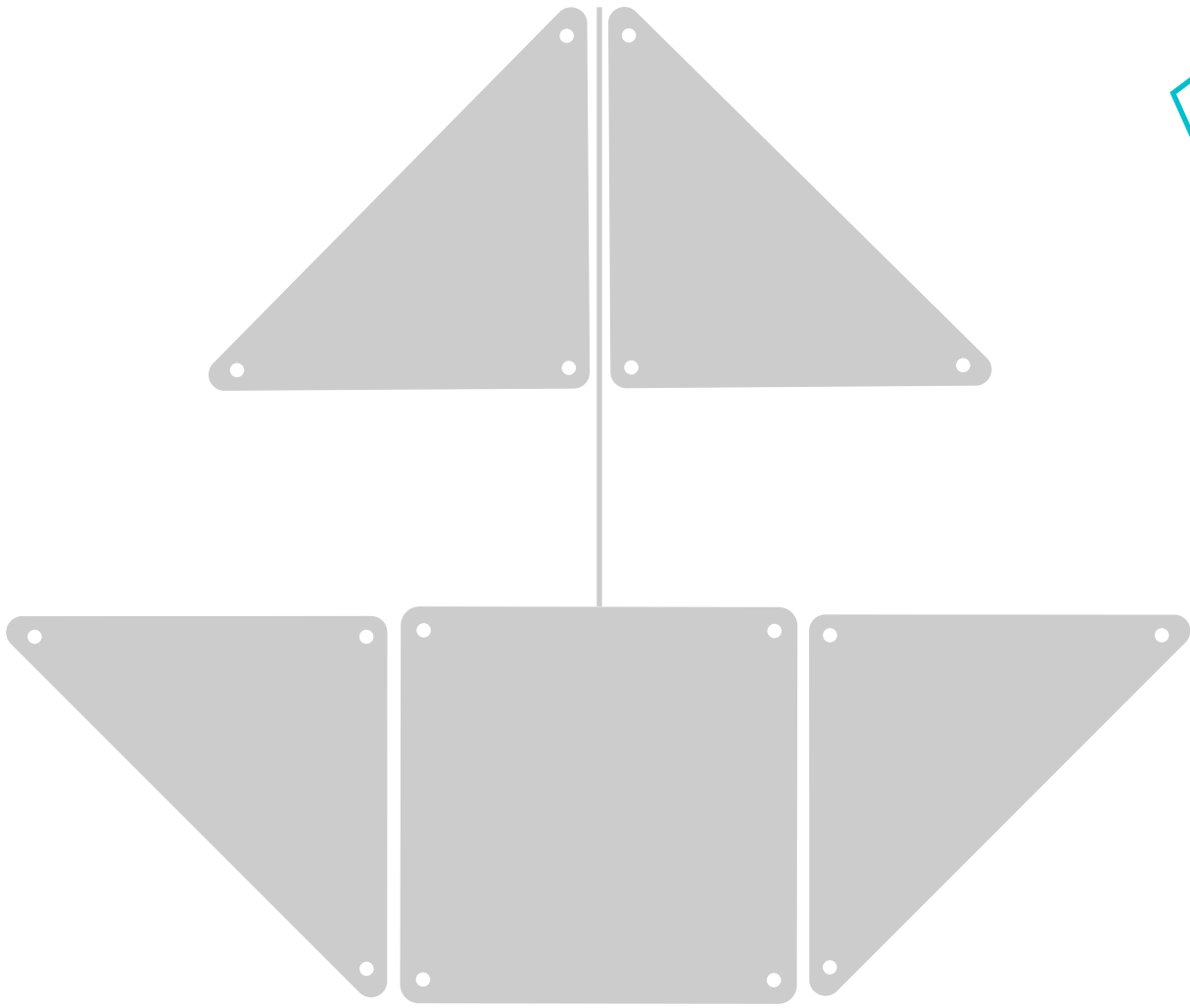
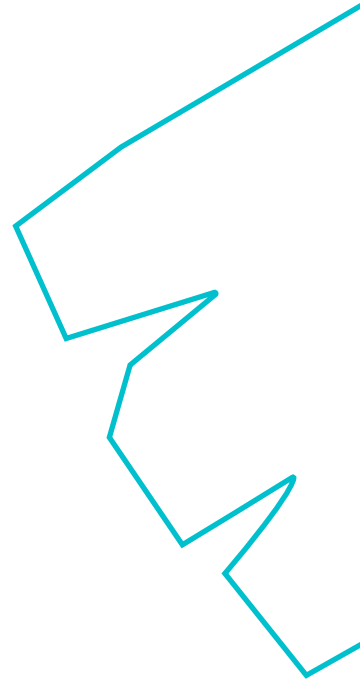
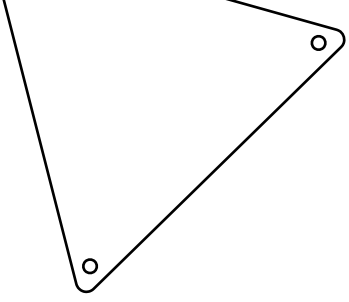

imanix.com

IMANIX[®]
by Braintoyz

La ballena

es el animal **mamífero** más grande de todos.

Elas respiran aire como nosotros, por lo que deben salir a la superficie del mar.

Esa agua que expulsan cerca de su cabeza es vapor que botan al exhalar.

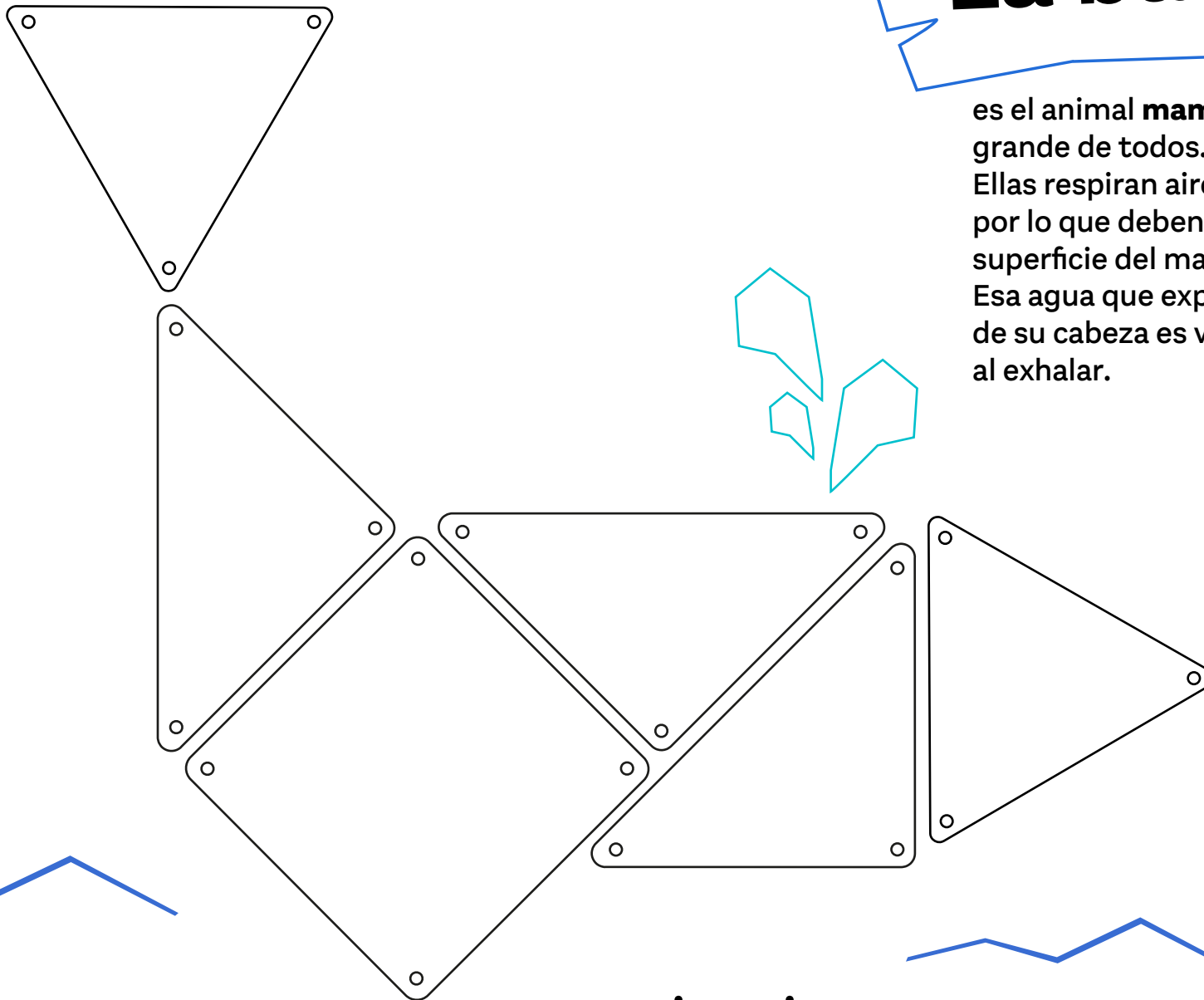
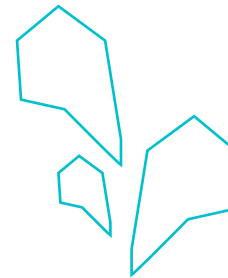

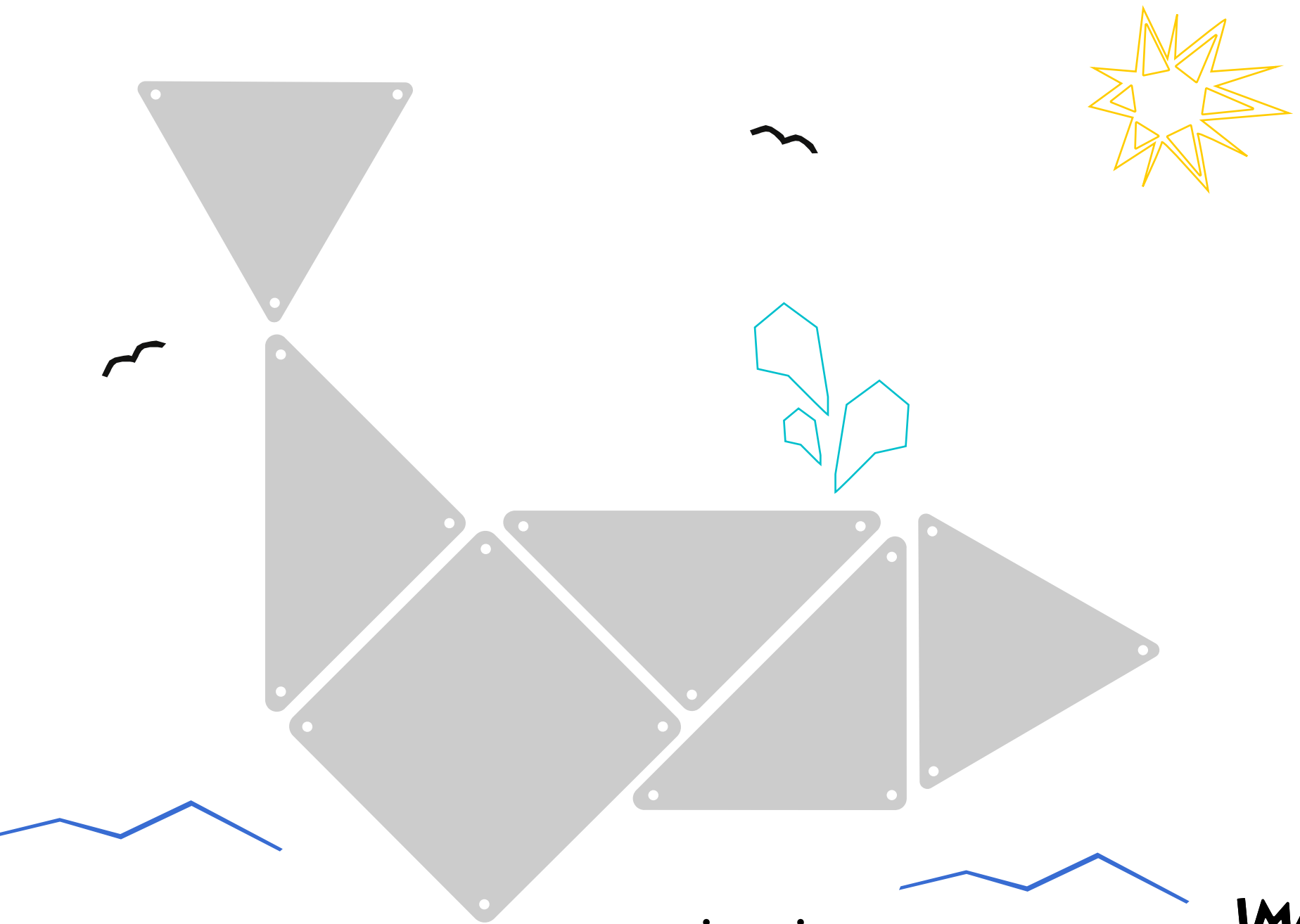

imanix.com

IMANIX[®]
by Braintoyz

Las medusas

tienen cuerpo gelatinoso y utilizan sus **tentáculos para inmovilizar y capturar a sus presas** con las toxinas que liberan.

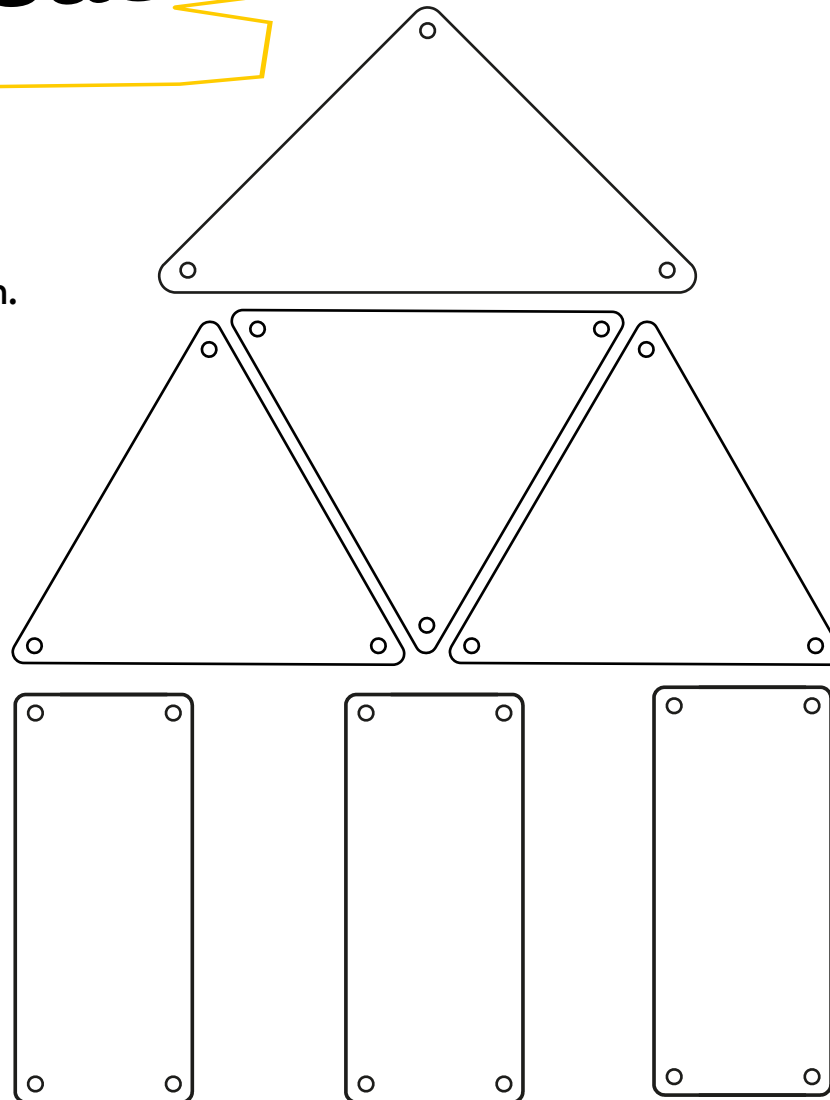

imanix.com

IMANIX[®]
by BrainToys

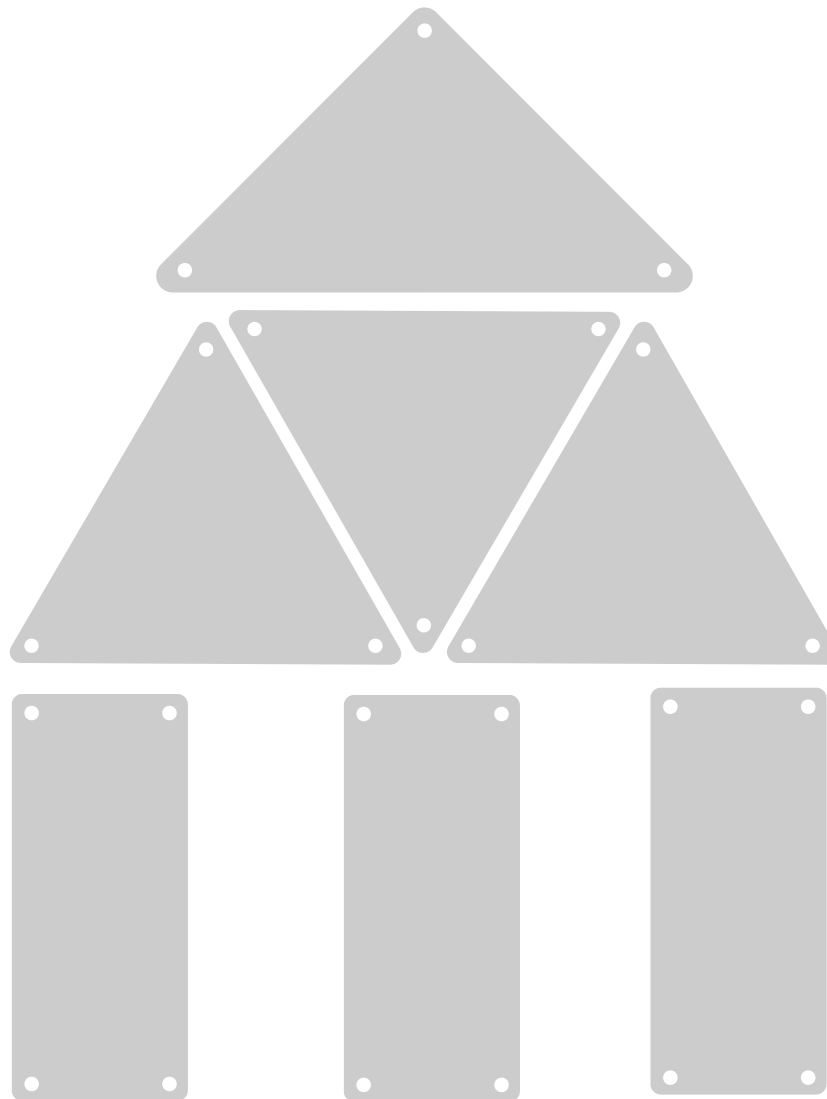
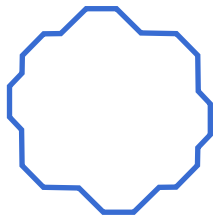
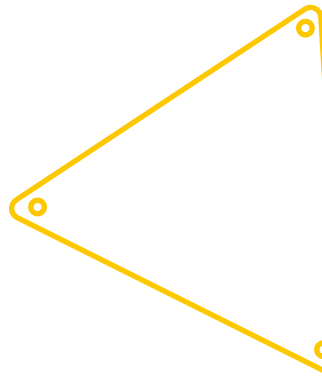
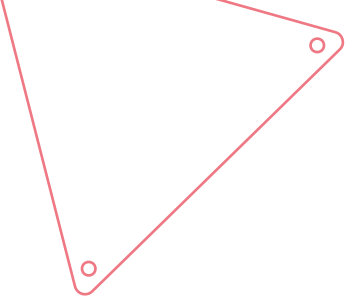

imanix.com

IMANIX[®]
by Braintoyz

Las estrellas de mar

son animales **carnívoros**.
Comen moluscos, almejas,
mejillones, ostras,
caracoles de mar, e incluso,
algunos peces de tamaño
pequeño.

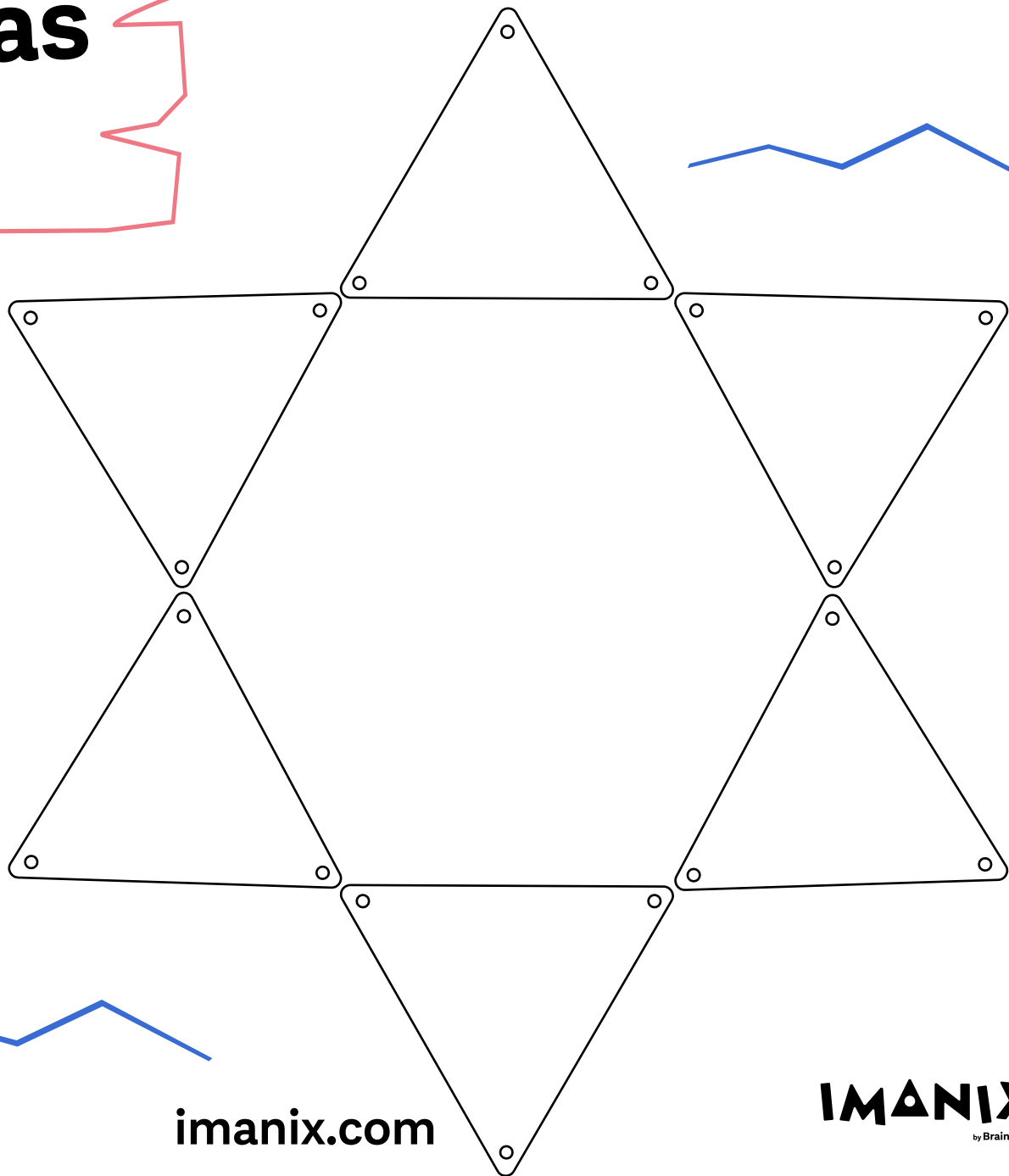
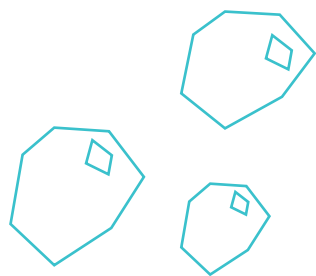

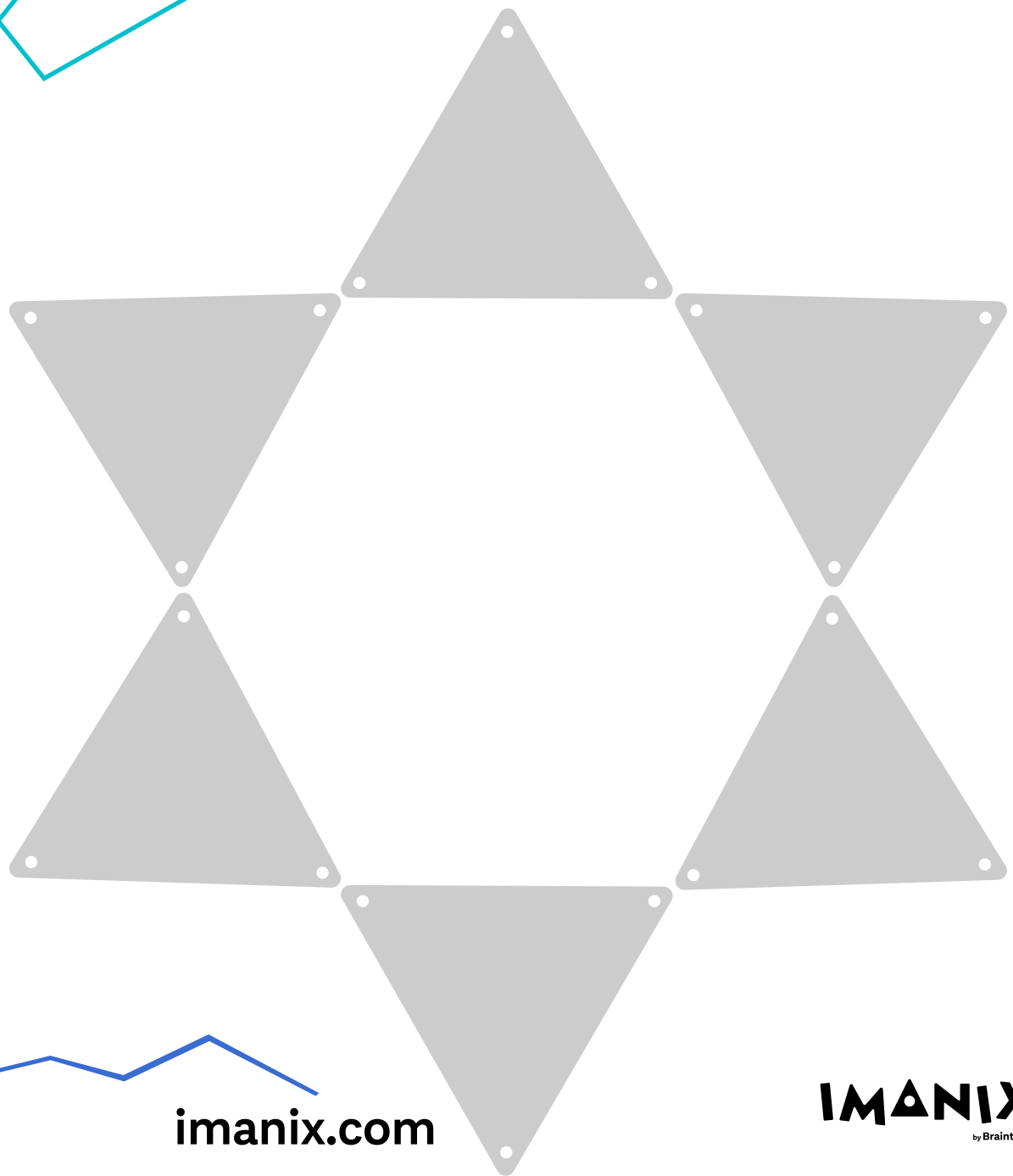
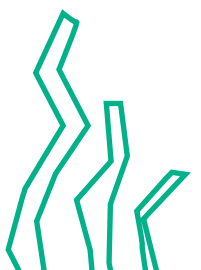
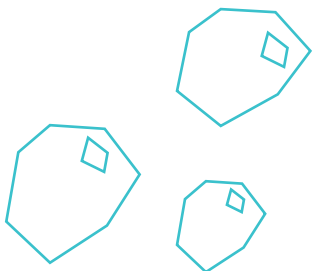
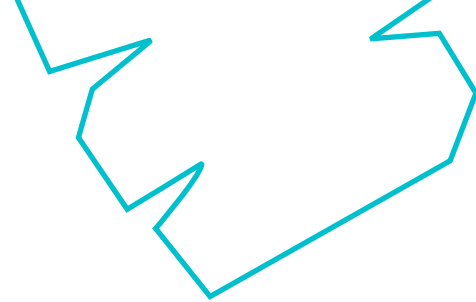

imanix.com

IMANIX[®]
by Braintoyz

Un submarino

es un tipo especial de buque capaz de navegar **bajo el agua** y también sobre la **superficie**.

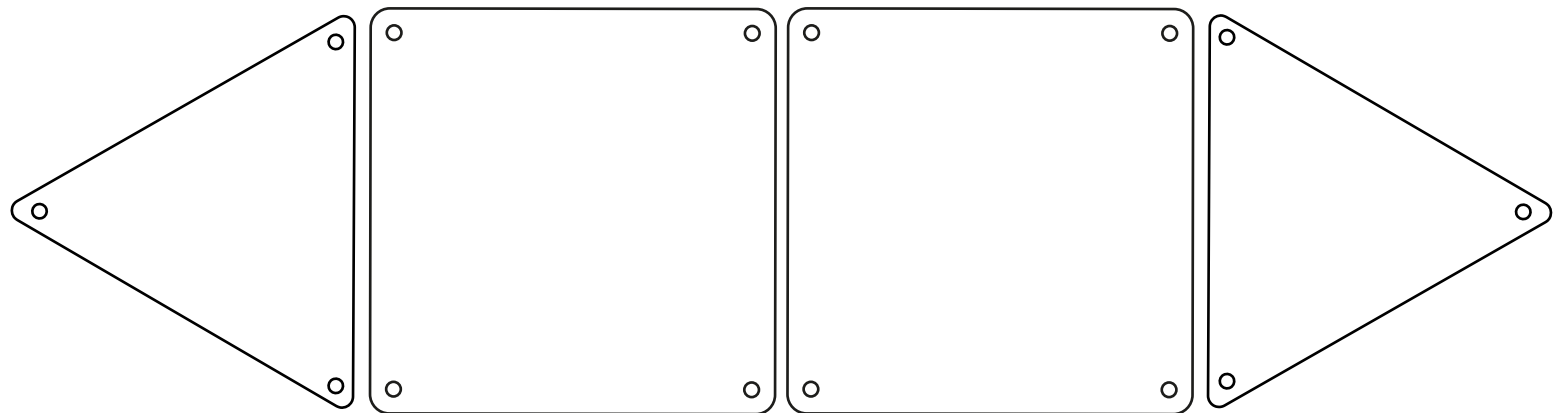
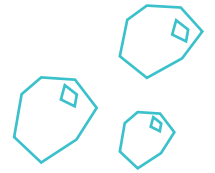

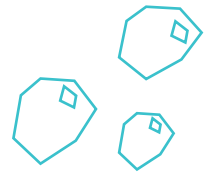
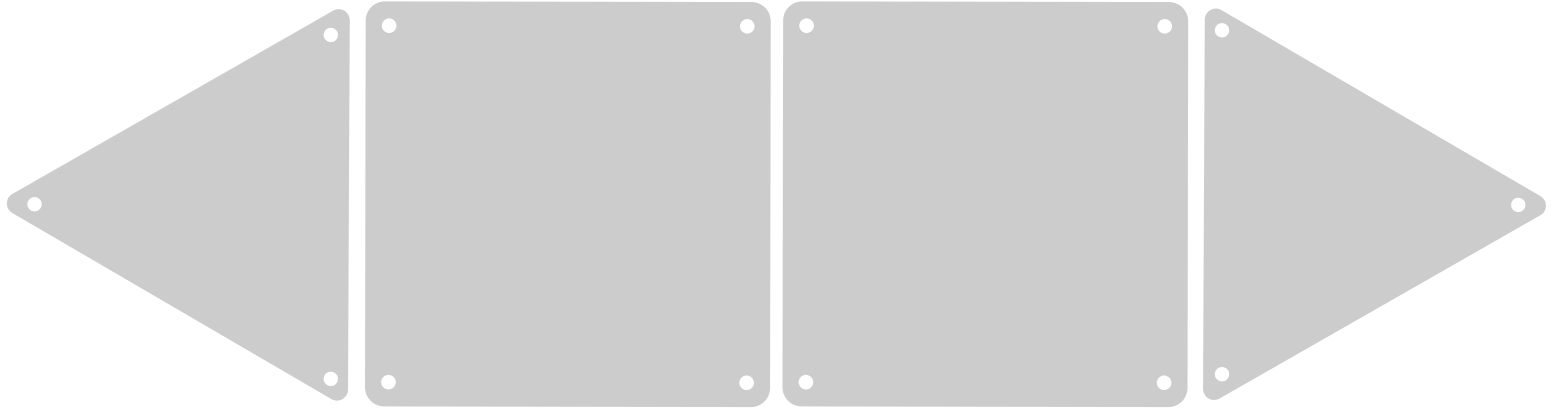
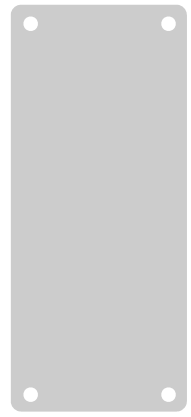
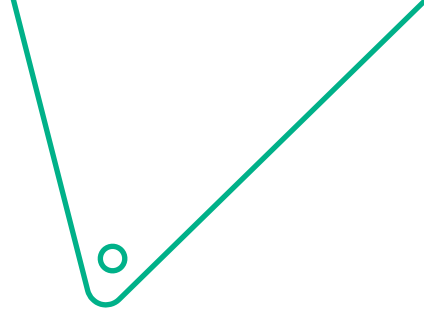

imanix.com

IMANIX[®]
by BrainToys

Los faros

son torres ubicadas cerca de la costa.
Antiguamente, mediante señales de luz,
**avisaban a los navegantes para que no
chocaran contra los acantilados** y zonas
escarpadas.

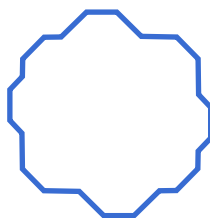
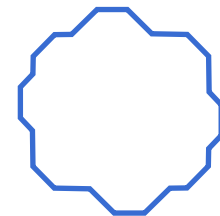
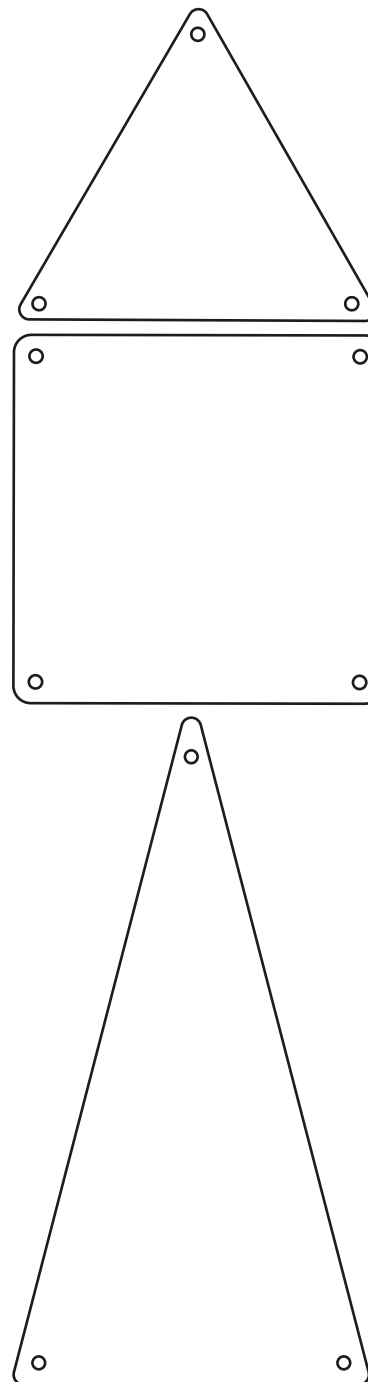

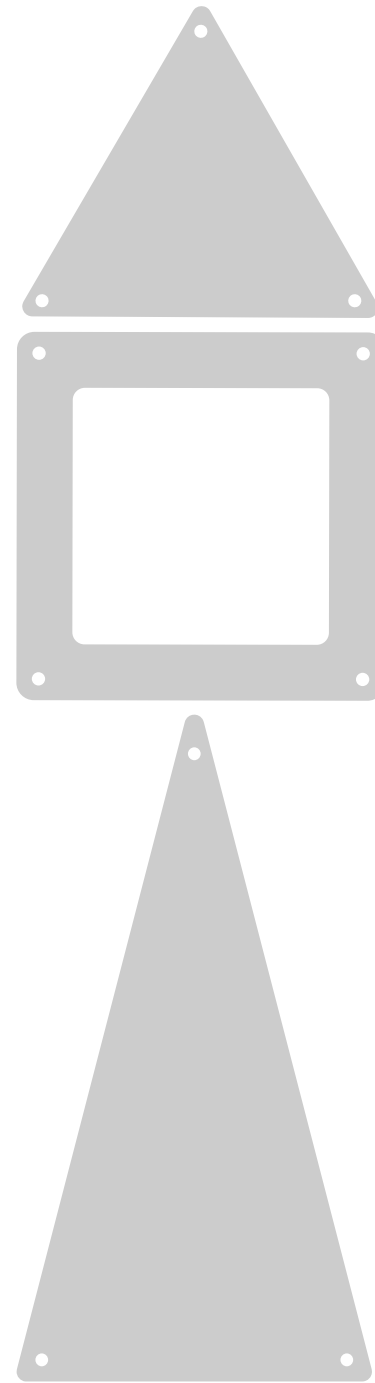
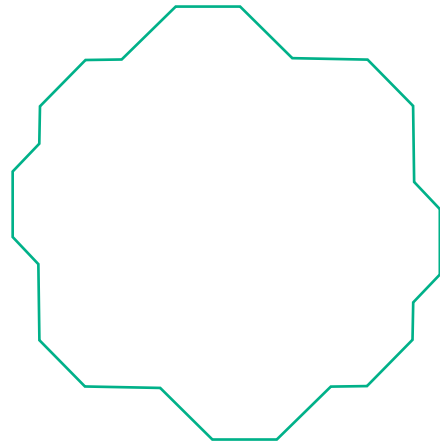

imanix.com

IMANIX[®]
by Braintoyz



Los patos

son aves muy sociales a las que les gusta mantenerse en suelo firme y también en el agua.

Los patos tienen en sus extremidades unas **membranas llamadas interdigitales que les permitan nadar.**

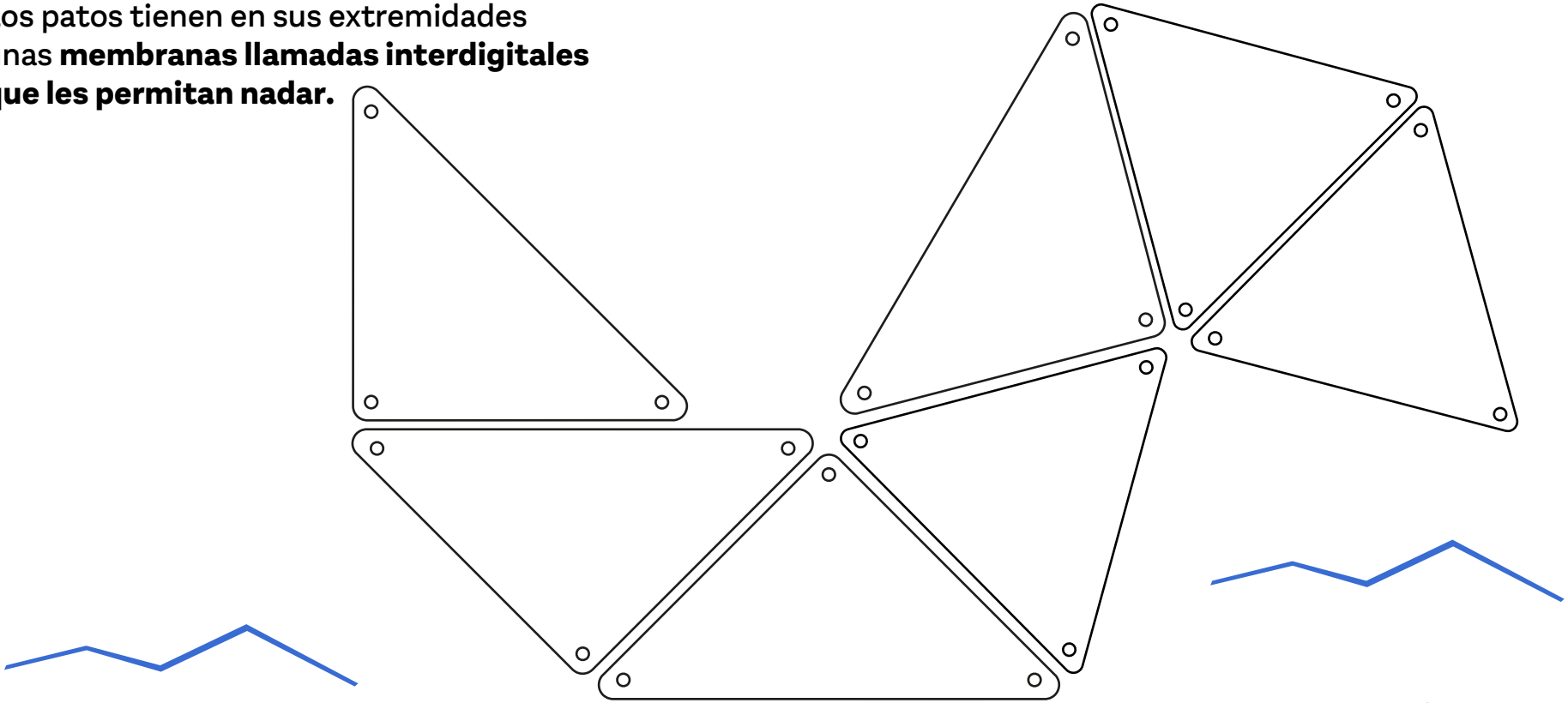

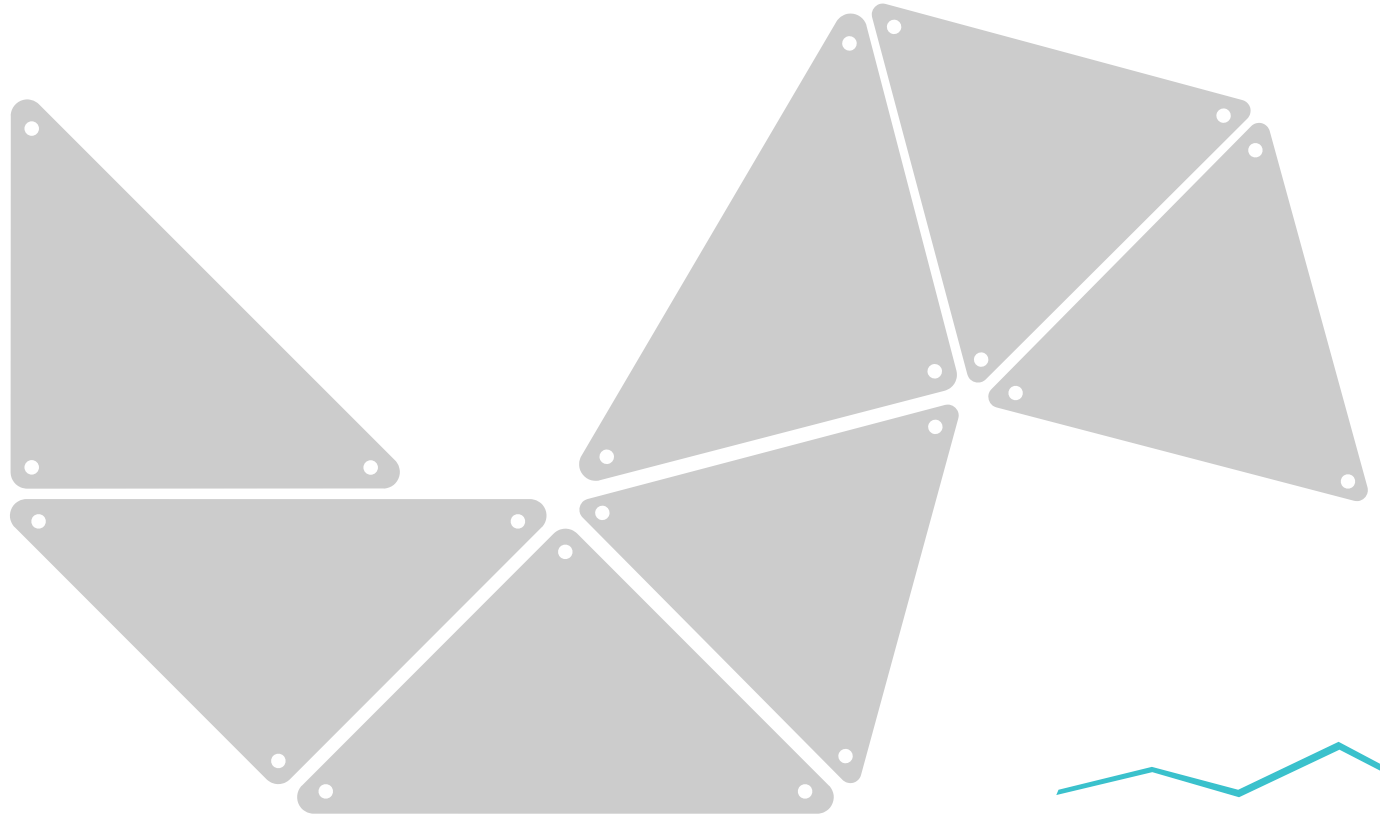
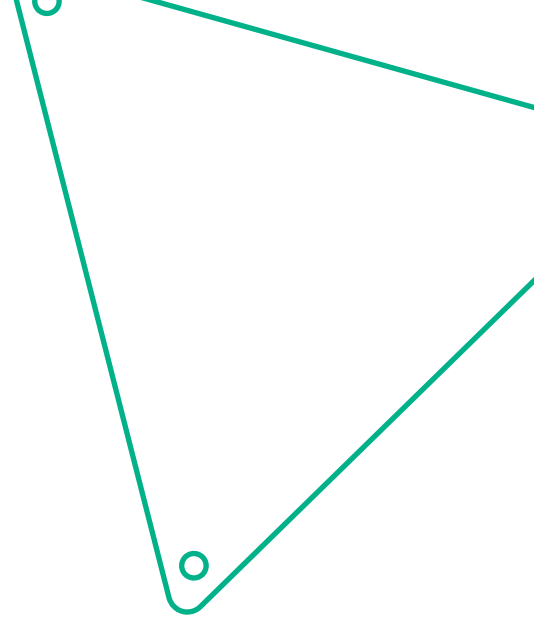
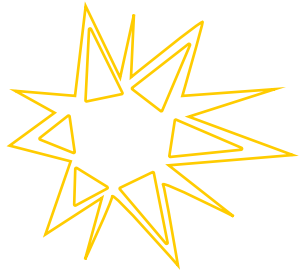

imanix.com

IMANIX[®]
by Braintoyz



IMANIX[®]

by Braintoys

Tómate una foto realizando el descargable y súbelo a nuestras redes sociales etiquetándonos como [@braintoys_cl](#).

imanix.com

 [@braintoys_cl](#)