

## PRODUCTS AND SERVICES

Spo2 Sensors & Adaptor Cables  
ECG Monitoring Cables & Leadwires  
NIBP Cuffs & Accessories  
IBP Cables & Transducers  
Temperature Probes & Adaptor Cables  
Muti-Parameter Patient Cables  
ECG Telemetry and Holter Leadwire  
Diagnostic ECG Cables & Accessories  
Disposable Monitoring Accessories  
Fetal Transducers & Accessories  
Veterinary Medical Accessories  
Spare Parts & Repair Services  
OEM & ODM Services  
Original Brand Devices

## 产品类目

血氧探头及血氧转接电缆  
心电监护电缆及附件  
无创血压袖套及附件  
有创血压电缆及传感器  
体温探头及转接线  
多参数电缆及附件  
心电遥测及动态心电导联线  
诊断类心电电缆及附件  
一次性监护附件  
胎监探头及附件  
动物医用配件耗材  
零部件及维修服务  
OEM和ODM服务  
贸易类产品



### Shenzhen Sino-K Medical Technology Co.,Ltd

A:4/F,Bldg2,Veteran Ind.City,Gongle Community,  
Xixiang Street,Baoan District ,Shenzhen  
T:+86 755 23341807 +86 755 23341804  
F:+86 755 23204076  
E:info@sino-k.com  
W:www.sino-k.com

### 深圳市中仓医疗科技有限公司

地址：深圳市宝安区西乡街道共乐社区西乡  
老兵工业城2栋4楼  
电话：+86 755 23341807 +86 755 23341804  
传真：+86 755 23204076  
邮箱：info@sino-k.com  
网址：www.sino-k.com



www.sino-k.com

版本号：v1.1.1



## Monitoring Accessories

## 监护仪配件

From Sino-K

源自·中仓





## C 企业简介

Corporate profile

Sino-K is a hi-tech manufacturer integrating professional R&D, production and sales in three field of Medical device, Electronics energy and Software development. We have a 1,600 square meters trial production workshop in Shenzhen city (First-Tier) and a 6,900 square meters production base in Maoming city (Second-Tier), a number of modernization production workshop, with advanced production testing device. We have a technical team of professional technical backbones and senior engineers which have more than 10 years experience in medical machinery and electronic energy R&D and production management.

Main Products Include:

Healthcare: Monitor and Medical software development, Nebulizer & Compression nebulizer, SpO2 sensors & Adaptor cables, ECG cables, EKG cables, NIBP cuffs, IBP cables, Temperature probes etc.

Electronics Energy: DC-DC Step up and down converters, AC-DC High frequency switching power supply, DC-AC off grid/grid tie inverter and software development etc. Widely used in cars, boats, telecom, solar energy systems, military, aerospace, medical and other industrial equipment.

We have passed TUV Nande, ISO13485 quality management system certification and SGS9001 certification, some products has passed CE and RoHS. Our products are sold to more than 100 countries and regions in the world, and established long-term cooperation relationships with global distributors.

We respective a enterprise spirit "Practical, Strive, Responsibility" and a business philosophy "Faithfulness, Mutual Benefit, Innovation", create a nice office and production environment. We in a new management model, perfect technology, best service and excellent quality as our fundamental of survival. We always adhere to customer first, service first, insist on using quality and service to benefit our customers.

**为响应国家“一带一路，中国制造2025”战略，特成立Sino-K公司与全球无缝对接。**

Sino-K公司是一家集专业研发、生产、销售医疗器械、电子能源及软件开发三大领域的高科技制造商。在一线城市（深圳市）设有工厂及试产车间1600平方米，二线城市（茂名市）拥有6900平方米生产基地，多间现代化生产车间，具备先进生产检测设备。拥有10年以上医疗、电子及软件开发专业技术管理骨干及高级工程师团队。

主营产品包括

医疗类：监护仪及医疗软件开发、雾化器及压缩雾化吸入机；血氧探头及延长/转接线，心电图线，心电图机线，血压袖套，血压连接管，有创压电缆，体温探头等。

电源类：DC-DC直流升降压防水电源转换器、AC-DC高频开关电源、DC-AC离/并网逆变器及软件开发等，广泛应用于汽车、游艇、电信、太阳能系统、军工、航天，医疗等工业设备。

公司已通过国际知名TUV南德ISO 13485质量管理体系认证及SGS9001认证，部份产品通过TUV南德CE、RoHS等国际知名认证公司认证。产品销往全球100多个国家和地区，并与全球分销商建立了长期合作关系。

公司尊崇“踏实、拼搏、责任”的企业精神，并以“诚信、共赢、创新”的经营理念，创造良好的办公及生产环境。以全新的管理模式，完善的技术，周到的服务，卓越的品质为生存根本。我们始终坚持以用户至上，用心服务于客户，坚持以质量、服务去互利客户。



# Directory

## 目录

Disposable SpO2 Sensors 一次性血氧探头	.....	001
REUSABLE SPO2 SENSORS 重复性血氧探头	.....	010
SPO2 ADAPTER CABLES 血氧转接线	.....	065
ECG CABLES&LEADWIRES 心电导联线	.....	078
EKG CABLES 心电图机导联线	.....	112
NIBP CUFFS 血压袖带	.....	124
NIBP ADAPTER HOSES 血压连接管	.....	131
IBP 有创血压(B)	.....	139
Temperature 体温(T)	.....	145
FETAL TRANSDUCER 胎监探头	.....	149



## Disposable SpO2 Sensors 一次性血氧探头

### Qualifications 资质



EN ISO 13485 质量体系认证



Medical Devices Manufacturing License  
医疗器械生产许可证



医疗器械注册证(中国)

### Regular Exhibitions 常年展会



中国 China



德国 Germany



美国 U.S.A.



迪拜 Dubai

### Certification 产品认证



### Compliance with 符合标准

ISO 13485: 2016

ISO10993-5-2009

ISO10993-10-2009

## Disposable SpO2 Sensors 一次性血氧探头

### Features and benefits

- ◆ **Adhesive Tape and Foam are available**  
无纺布, 泡棉可用
- ◆ **Latex-free**  
不含乳胶
- ◆ **Available in adult, pediatric, infant and Neonate sizes**  
成人, 儿童, 婴儿, 新生儿可用
- ◆ **Single patient use to reduce cross-contamination**  
单个病人使用, 减少交叉感染



Product types 产品类型	Photo 图片	P/N Example 型号示例	P/N Guide 型号识别
Adhesive Tape sensor 无纺布粘性探头		SP 10 19	S: Sino-K P: SpO2 1: disposable sensors 0: Neonate/adult adhesive sensor (1: Infant; 2: Pediatric; 3: Adult) 19: Nellcor (10: GE-Datex; 19A: Nellcor Oximax)
Non-Adhesive Foam sensor 海绵非粘性探头		SP 18 19	S: Sino-K P: SpO2 1: disposable sensors 8: Neonate/adult foam non-adhesive sensor (9: Infant/Pediatric) 19: Nellcor Non-Oximax (03: BCI; 10: GE-Datex)
Adhesive Foam sensor 泡绵粘性探头		SP 14 19	S: Sino-K P: SpO2 1: disposable sensors 4: Neonate/adult foam adhesive sensor (5: Infant; 6: Pediatric; 7: Adult) 19: Nellcor(03: BCI; 10: GE-Datex)

Warranty: no warranty for disposable sensors except defectiveness found in the first use  
Package: 1pcs/bag, 24pcs/box  
保修: 第一次使用时, 若存在质量问题, 换新  
包装: 1个/包, 24个/箱

### BCI Disposable Sensors 一次性血氧探头

Product types 类别	Connector 接头	Options 探头类型	Sino-K P/N 型号	OEM # 原装型号	Len. 长度
Adhesive Tape sensor 粘性探头型号		Neonate/Adult 成人 /新生儿(<3kg/>40kg)	SP1003	1302	0.9m
		Infant 婴儿(3-20kg)	SP1103	1303	0.9m
		Pediatric 儿童(10-50kg)	SP1203	1301	0.9m
		Adult 成人(>30kg)	SP1303	1300	0.9m
Adhesive Foam sensor 泡绵粘性探头		Neonate/Adult 成人 /新生儿(<3kg/>40kg)	SP1403	1302	0.9m
		Infant 婴儿(3-20kg)	SP1503	1303	0.9m
		Pediatric 儿童(10-50kg)	SP1603	1301	0.9m
		Adult 成人(>30kg)	SP1703	1300	0.9m
Non-Adhesive Foam sensor 海绵非粘性探头		Neonate/Adult 成人 /新生儿(<3kg/>40kg)	SP1803	1302	0.9m
		Infant 婴儿(3-20kg)	SP1903	1303	0.9m
		Pediatric 儿童(10-50kg)	SP1903	1301	0.9m
		Adult 成人(>30kg)	SP1803	1300	0.9m



### Criticare Disposable Sensors 一次性血氧探头

Product types 类别	Connector 接头	Options 探头类型	Sino-K P/N 型号	OEM # 原装型号	Len. 长度
Adhesive Tape sensor 粘性探头型号		Neonate/Adult 成人 /新生儿(<3kg/>40kg)	SP1007A	573SD	0.9m
		Infant 婴儿(3-20kg)	SP1107A	572SD	0.9m
		Pediatric 儿童(10-50kg)	SP1207A	571SD	0.9m
		Adult 成人(>30kg)	SP1307A	570SD	0.9m
Adhesive Foam sensor 泡绵粘性探头		Neonate/Adult 成人 /新生儿(<3kg/>40kg)	SP1407A	573SD	0.9m
		Infant 婴儿(3-20kg)	SP1507A	572SD	0.9m
		Pediatric 儿童(10-50kg)	SP1607A	571SD	0.9m
		Adult 成人(>30kg)	SP1707A	570SD	0.9m
Non-Adhesive Foam sensor 海绵非粘性探头		Neonate/Adult 成人 /新生儿(<3kg/>40kg)	SP1807A	573SD	0.9m
		Infant 婴儿(3-20kg)	SP1907A	572SD	0.9m
		Pediatric 儿童(10-50kg)	SP1907A	571SD	0.9m
		Adult 成人(>30kg)	SP1807A	570SD	0.9m



Datascope Disposable Sensors 一次性血氧探头

Product types 类别	Connector 接头	Options 探头类型	Sino-K P/N 型号	OEM # 原装型号	Len. 长度
Adhesive Tape sensor 粘性探头型号	 SCN08	Neonate/Adult 成人 /新生儿(<3kg/>40kg)	SP1008	0998-00-0074-04	0.9m
		Infant 婴儿(3-20kg)	SP1108	0998-00-0074-03	0.9m
		Pediatric 儿童(10-50kg)	SP1208	0998-00-0074-04	0.9m
		Adult 成人(>30kg)	SP1308	0998-00-0076-05	0.9m
Adhesive Foam sensor 海绵粘性探头	 SCN08	Neonate/Adult 成人 /新生儿(<3kg/>40kg)	SP1408	0998-00-0074-04	0.9m
		Infant 婴儿(3-20kg)	SP1508	0998-00-0074-03	0.9m
		Pediatric 儿童(10-50kg)	SP1608	0998-00-0074-04	0.9m
		Adult 成人(>30kg)	SP1708	0998-00-0076-05	0.9m
Non-Adhesive Foam sensor 海绵非粘性探头	 SCN08	Neonate/Adult 成人 /新生儿(<3kg/>40kg)	SP1808	0998-00-0074-04	0.9m
		Infant 婴儿(3-20kg)	SP1908	0998-00-0074-03	0.9m
		Pediatric 儿童(10-50kg)	SP1908	0998-00-0074-04	0.9m
		Adult 成人(>30kg)	SP1808	0998-00-0076-05	0.9m

GE-Datex Disposable Sensors 德恩一次性血氧探头

Product types 类别	Connector 接头	Options 探头类型	Sino-K P/N 型号	OEM # 原装型号	Len. 长度
Adhesive Tape sensor 粘性探头型号	 SCN04-32	Neonate/Adult 成人 /新生儿(<3kg/>40kg)	SP1010	SAS-AF	0.9m
		Infant 婴儿(3-20kg)	SP1110	SAS-AF	0.9m
		Pediatric 儿童(10-50kg)	SP1210	SAS-AF/SAS-AF	0.9m
		Adult 成人(>30kg)	SP1310	SAS-AF/SAS-AF	0.9m
Adhesive Foam sensor 海绵粘性探头	 SCN04-32	Neonate/Adult 成人 /新生儿(<3kg/>40kg)	SP1410	SAS-AF	0.9m
		Infant 婴儿(3-20kg)	SP1510	SAS-AF	0.9m
		Pediatric 儿童(10-50kg)	SP1610	SAS-AF/SAS-AF	0.9m
		Adult 成人(>30kg)	SP1710	SAS-AF/SAS-AF	0.9m
Non-Adhesive Foam sensor 海绵非粘性探头	 SCN04-32	Neonate/Adult 成人 /新生儿(<3kg/>40kg)	SP1810	SAS-AF	0.9m
		Infant 婴儿(3-20kg)	SP1910	SAS-AF	0.9m
		Pediatric 儿童(10-50kg)	SP1910	SAS-AF/SAS-AF	0.9m
		Adult 成人(>30kg)	SP1810	SAS-AF/SAS-AF	0.9m







GE-TruSignal Disposable Sensors 一次性血氧探头

Product types 类别	Connector 接头	Options 探头类型	Sino-K P/N 型号	OEM # 原装型号	Len. 长度
Adhesive Tape sensor 粘性探头型号	 SCN64	Neonate/Adult 成人 /新生儿(<3kg/>40kg)	SP1010S	TS-AF-10 TS-AF-25	0.9m
		Infant 婴儿(3-20kg)	SP1110S	TS-AF-10 TS-AF-25	0.9m
		Pediatric 儿童(10-50kg)	SP1210S	TS-AF-10 TS-AF-25	0.9m
		Adult 成人(>30kg)	SP1310S	TS-AF-10 TS-AF-25	0.9m
Adhesive Foam sensor 海绵粘性探头	 SCN64	Neonate/Adult 成人 /新生儿(<3kg/>40kg)	SP1410S	TS-AF-10 TS-AF-25	0.9m
		Infant 婴儿(3-20kg)	SP1510S	TS-AF-10 TS-AF-25	0.9m
		Pediatric 儿童(10-50kg)	SP1610S	TS-AF-10 TS-AF-25	0.9m
		Adult 成人(>30kg)	SP1710S	TS-AF-10 TS-AF-25	0.9m
Non-Adhesive Foam sensor 海绵非粘性探头	 SCN64	Neonate/Adult 成人 /新生儿(<3kg/>40kg)	SP1810S	TS-AF-10 TS-AF-25	0.9m
		Infant 婴儿(3-20kg)	SP1910S	TS-AF-10 TS-AF-25	0.9m
		Pediatric 儿童(10-50kg)	SP1910S	TS-AF-10 TS-AF-25	0.9m
		Adult 成人(>30kg)	SP1810S	TS-AF-10 TS-AF-25	0.9m

GE-OXYTIP+ Disposable Sensors 一次性血氧探头

Product types 类别	Connector 接头	Options 探头类型	Sino-K P/N 型号	OEM # 原装型号	Len. 长度
Adhesive Tape sensor 粘性探头型号	 SCN17	Neonate/Adult 成人 /新生儿(<3kg/>40kg)	SP1010L	OXY-AF-10	0.9m
		Infant 婴儿(3-20kg)	SP1110L	OXY-AF-10	0.9m
		Pediatric 儿童(10-50kg)	SP1210L	OXY-AF-10	0.9m
		Adult 成人(>30kg)	SP1310L	OXY-AF-10	0.9m
Adhesive Foam sensor 海绵粘性探头	 SCN17	Neonate/Adult 成人 /新生儿(<3kg/>40kg)	SP1410L	OXY-AF-10	0.9m
		Infant 婴儿(3-20kg)	SP1510L	OXY-AF-10	0.9m
		Pediatric 儿童(10-50kg)	SP1610L	OXY-AF-10	0.9m
		Adult 成人(>30kg)	SP1710L	OXY-AF-10	0.9m
Non-Adhesive Foam sensor 海绵非粘性探头	 SCN17	Neonate/Adult 成人 /新生儿(<3kg/>40kg)	SP1810L	OXY-AF-10	0.9m
		Infant 婴儿(3-20kg)	SP1910L	OXY-AF-10	0.9m
		Pediatric 儿童(10-50kg)	SP1910L	OXY-AF-10	0.9m
		Adult 成人(>30kg)	SP1810L	OXY-AF-10	0.9m

Masim Disposable Sensors 一次性血氧探头

Product types 类别	Connector 接头	Options 探头类型	Sino-K P/N 型号	OEM # 原装型号	Len. 长度
Adhesive Tape sensor 粘性探头型号		Neonate/Adult 成人 /新生儿(<3kg/>40kg)	SP1015A	1862	0.9m
		Infant 婴儿(3-20kg)	SP1115A	1861	0.9m
		Pediatric 儿童(10-50kg)	SP1215A	1860	0.9m
		Adult 成人(>30kg)	SP1315A	1859	0.9m
Adhesive Foam sensor 泡沫粘性探头		Neonate/Adult 成人 /新生儿(<3kg/>40kg)	SP1415A	1862	0.9m
		Infant 婴儿(3-20kg)	SP1515A	1861	0.9m
		Pediatric 儿童(10-50kg)	SP1615A	1860	0.9m
		Adult 成人(>30kg)	SP1715A	1859	0.9m
Non-Adhesive Foam sensor 海绵非粘性探头		Neonate/Adult 成人 /新生儿(<3kg/>40kg)	SP1815A	1862	0.9m
		Infant 婴儿(3-20kg)	SP1915A	1861	0.9m
		Pediatric 儿童(10-50kg)	SP1915A	1860	0.9m
		Adult 成人(>30kg)	SP1815A	1859	0.9m
Adhesive Tape sensor 粘性探头型号		Neonate/Adult 成人 /新生儿(<3kg/>40kg)	SP1015B	1002	0.9m
		Infant 婴儿(3-20kg)	SP1115B		0.9m
		Pediatric 儿童(10-50kg)	SP1215B	1025	0.9m
		Adult 成人(>30kg)	SP1315B	1001	0.9m
Adhesive Foam sensor 泡沫粘性探头		Neonate/Adult 成人 /新生儿(<3kg/>40kg)	SP1415B	1002	0.9m
		Infant 婴儿(3-20kg)	SP1515B		0.9m
		Pediatric 儿童(10-50kg)	SP1615B	1025	0.9m
		Adult 成人(>30kg)	SP1715B	1001	0.9m
Non-Adhesive Foam sensor 海绵非粘性探头		Neonate/Adult 成人 /新生儿(<3kg/>40kg)	SP1815B	1002	0.9m
		Infant 婴儿(3-20kg)	SP1915B		0.9m
		Pediatric 儿童(10-50kg)	SP1915B	1025	0.9m
		Adult 成人(>30kg)	SP1815B	1001	0.9m



Masim Disposable Sensors 一次性血氧探头

Product types 类别	Connector 接头	Options 探头类型	Sino-K P/N 型号	OEM # 原装型号	Len. 长度
Adhesive Tape sensor 粘性探头型号		Neonate/Adult 成人 /新生儿(<3kg/>40kg)	SP1015H		0.9m
		Infant 婴儿(3-20kg)	SP1115H		0.9m
		Pediatric 儿童(10-50kg)	SP1215H		0.9m
		Adult 成人(>30kg)	SP1315H		0.9m
Adhesive Foam sensor 泡沫粘性探头		Neonate/Adult 成人 /新生儿(<3kg/>40kg)	SP1415H		0.9m
		Infant 婴儿(3-20kg)	SP1515H		0.9m
		Pediatric 儿童(10-50kg)	SP1615H		0.9m
		Adult 成人(>30kg)	SP1715H		0.9m
Non-Adhesive Foam sensor 海绵非粘性探头		Neonate/Adult 成人 /新生儿(<3kg/>40kg)	SP1815H		0.9m
		Infant 婴儿(3-20kg)	SP1915H		0.9m
		Pediatric 儿童(10-50kg)	SP1915H		0.9m
		Adult 成人(>30kg)	SP1815H		0.9m



Nonin Disposable Sensors 燕牌一次性血氧探头

Product types 类别	Connector 接头	Options 探头类型	Sino-K P/N 型号	OEM # 原装型号	Len. 长度
Adhesive Tape sensor 粘性探头型号		Neonate/Adult 成人 /新生儿(<3kg/>40kg)	SP1022	9000N	0.9m
		Infant 婴儿(3-20kg)	SP1122	9000 I	0.9m
		Pediatric 儿童(10-50kg)	SP1222	9000P	0.9m
		Adult 成人(>30kg)	SP1322	9000A	0.9m
Adhesive Foam sensor 泡沫粘性探头		Neonate/Adult 成人 /新生儿(<3kg/>40kg)	SP1422	9000N	0.9m
		Infant 婴儿(3-20kg)	SP1522	9000 I	0.9m
		Pediatric 儿童(10-50kg)	SP1622	9000P	0.9m
		Adult 成人(>30kg)	SP1722	9000A	0.9m
Non-Adhesive Foam sensor 海绵非粘性探头		Neonate/Adult 成人 /新生儿(<3kg/>40kg)	SP1822	9000N	0.9m
		Infant 婴儿(3-20kg)	SP1922	9000 I	0.9m
		Pediatric 儿童(10-50kg)	SP1922	9000P	0.9m
		Adult 成人(>30kg)	SP1822	9000A	0.9m







Novamatrix Disposable Sensors 诺医一次性血氧探头

Product types 类别	Connector 接头	Options 探头类型	Sino-K P/N 型号	OEM # 原装型号	Len. 长度
Adhesive Tape sensor 粘性探头型号	 SCN04-32	Neonate/Adult 成人 /新生儿(<3kg/>40kg)	SP1023	AS140	0.9m
		Infant 婴儿(3-20kg)	SP1123	AS120	0.9m
		Pediatric 儿童(10-50kg)	SP1223	AS120	0.9m
		Adult 成人(>30kg)	SP1323	AS110	0.9m
Adhesive Foam sensor 海绵粘性探头	 SCN04-32	Neonate/Adult 成人 /新生儿(<3kg/>40kg)	SP1423	AS140	0.9m
		Infant 婴儿(3-20kg)	SP1523	AS120	0.9m
		Pediatric 儿童(10-50kg)	SP1623	AS120	0.9m
		Adult 成人(>30kg)	SP1723	AS110	0.9m
Non-Adhesive Foam sensor 海绵非粘性探头	 SCN04-32	Neonate/Adult 成人 /新生儿(<3kg/>40kg)	SP1823	AS140	0.9m
		Infant 婴儿(3-20kg)	SP1923	AS120	0.9m
		Pediatric 儿童(10-50kg)	SP1923	AS120	0.9m
		Adult 成人(>30kg)	SP1823	AS110	0.9m

Nihon Kohden Disposable Sensors 光电一次性血氧探头

Product types 类别	Connector 接头	Options 探头类型	Sino-K P/N 型号	OEM # 原装型号	Len. 长度
Adhesive Tape sensor 粘性探头型号	 SCN33	Neonate/Adult 成人 /新生儿(<3kg/>40kg)	SP1021	TL-253T	0.9m
		Infant 婴儿(3-20kg)	SP1121	TL-252T	0.9m
		Pediatric 儿童(10-50kg)	SP1221	TL-252T	0.9m
		Adult 成人(>30kg)	SP1321	TL-251T	0.9m
Adhesive Foam sensor 海绵粘性探头	 SCN33	Neonate/Adult 成人 /新生儿(<3kg/>40kg)	SP1421	TL-253T	0.9m
		Infant 婴儿(3-20kg)	SP1521	TL-252T	0.9m
		Pediatric 儿童(10-50kg)	SP1621	TL-252T	0.9m
		Adult 成人(>30kg)	SP1721	TL-251T	0.9m
Non-Adhesive Foam sensor 海绵非粘性探头	 SCN33	Neonate/Adult 成人 /新生儿(<3kg/>40kg)	SP1821	TL-253T	0.9m
		Infant 婴儿(3-20kg)	SP1921	TL-252T	0.9m
		Pediatric 儿童(10-50kg)	SP1921	TL-252T	0.9m
		Adult 成人(>30kg)	SP1821	TL-251T	0.9m

Nellcor Disposable Sensors 一次性血氧探头

Product types 类别	Connector 接头	Options 探头类型	Sino-K P/N 型号	OEM # 原装型号	Len. 长度
Adhesive Tape sensor 粘性探头型号	 SCN30-32	Neonate/Adult 成人 /新生儿(<3kg/>40kg)	SP1019	N25	0.9m
		Infant 婴儿(3-20kg)	SP1119	I20	0.9m
		Pediatric 儿童(10-50kg)	SP1219	D20	0.9m
		Adult 成人(>30kg)	SP1319	D25	0.9m
Adhesive Foam sensor 海绵粘性探头	 SCN30-32	Neonate/Adult 成人 /新生儿(<3kg/>40kg)	SP1419	N25	0.9m
		Infant 婴儿(3-20kg)	SP1519	I20	0.9m
		Pediatric 儿童(10-50kg)	SP1619	D20	0.9m
		Adult 成人(>30kg)	SP1719	D25	0.9m
Non-Adhesive Foam sensor 海绵非粘性探头	 SCN30-32	Neonate/Adult 成人 /新生儿(<3kg/>40kg)	SP1819	N25	0.9m
		Infant 婴儿(3-20kg)	SP1919	I20	0.9m
		Pediatric 儿童(10-50kg)	SP1919	D20	0.9m
		Adult 成人(>30kg)	SP1819	D25	0.9m
Adhesive Tape sensor 粘性探头型号	 SCN31-32	Neonate/Adult 成人 /新生儿(<3kg/>40kg)	SP1019A	MAX-N	0.9m
		Infant 婴儿(3-20kg)	SP1119A	MAX-I	0.9m
		Pediatric 儿童(10-50kg)	SP1219A	MAX-P	0.9m
		Adult 成人(>30kg)	SP1319A	MAX-A	0.9m
Adhesive Foam sensor 海绵粘性探头	 SCN31-32	Neonate/Adult 成人 /新生儿(<3kg/>40kg)	SP1419A	MAX-N	0.9m
		Infant 婴儿(3-20kg)	SP1519A	MAX-I	0.9m
		Pediatric 儿童(10-50kg)	SP1619A	MAX-P	0.9m
		Adult 成人(>30kg)	SP1719A	MAX-A	0.9m
Non-Adhesive Foam sensor 海绵非粘性探头	 SCN31-32	Neonate/Adult 成人 /新生儿(<3kg/>40kg)	SP1819A	MAX-N	0.9m
		Infant 婴儿(3-20kg)	SP1919A	MAX-I	0.9m
		Pediatric 儿童(10-50kg)	SP1919A	MAX-P	0.9m
		Adult 成人(>30kg)	SP1819A	MAX-A	0.9m

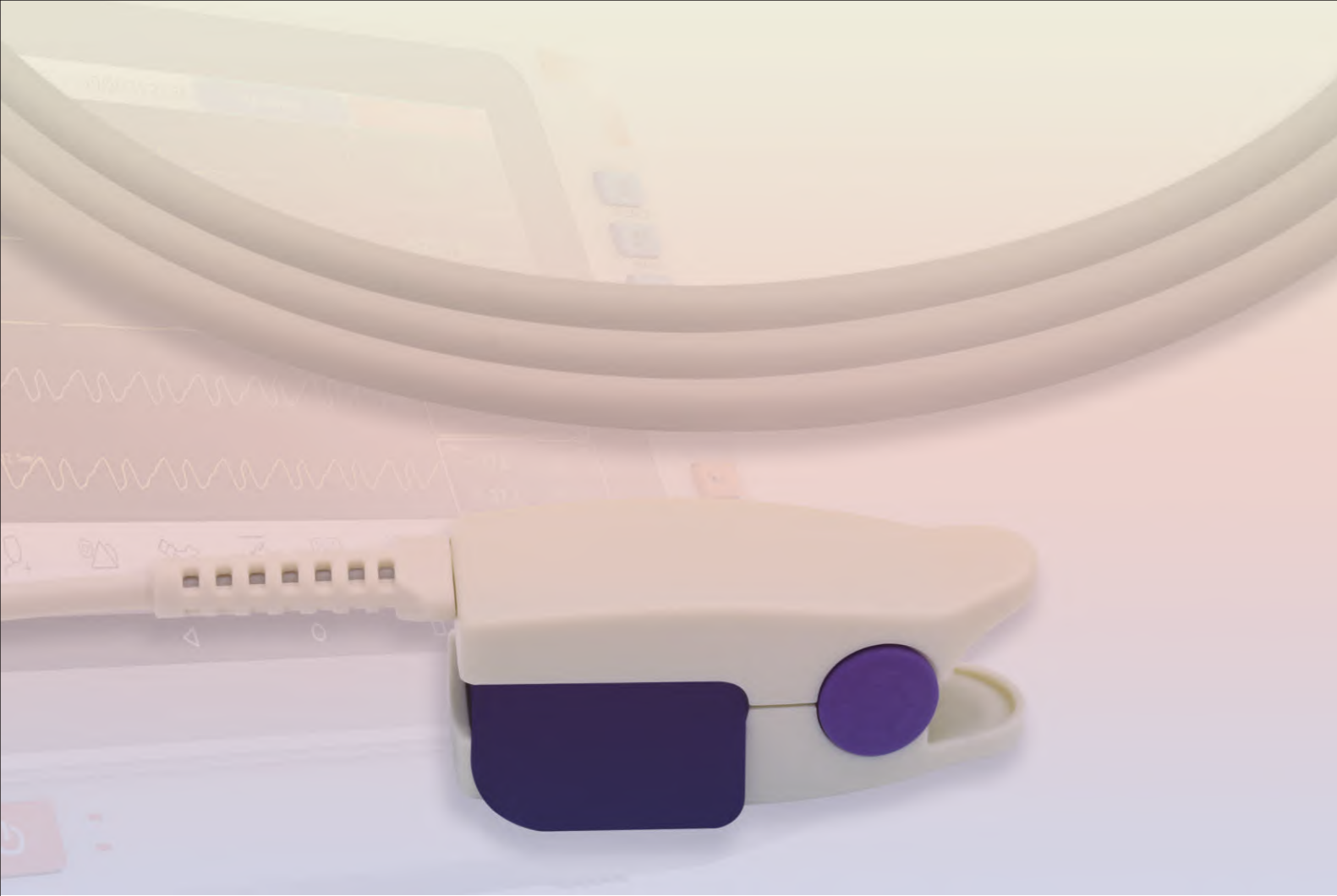

## Reusable SpO<sub>2</sub> Sensors 重复性血氧探头

### Features and benefits

- ◆ **Cost-effective 12 months' warranty**  
最优性价比，12月质保
- ◆ **Guaranteed compatibility to the original sensor regarding accuracy and specification**  
精度和规格上与原装探头完美兼容
- ◆ **Use of latex free and biocompatible components**  
使用具有生物兼容性和不含乳胶的原材料
- ◆ **Large variety of SpO<sub>2</sub> sensors compatible to leading monitoring manufacturers**  
兼容大多数监护仪品牌
- ◆ **Comfortable Easy to clean and disinfect by immersing or wiping with many popular disinfectant solutions**  
舒适 易于清洗和消毒
- ◆ **These durable sensors come in sizes to fit a wide variety of patients from large neonates to adults**  
新生儿到成人各种尺寸，满足于不同病人的需求





## Reusable SpO<sub>2</sub> Sensors 重复性血氧探头

### Certification 产品认证



### Compliance with 符合标准

- ISO EN 9919-2005
- ISO10993-5-2009
- ISO10993-10-2009
- EN 60601-1:1990
- ISO 13485: 2016

Product types 产品类型	Photo 图片	P/N Example 型号示例	P/N Guide 型号识别
Reusable SpO <sub>2</sub> Sensors 重复性血氧探头		SP 8 3 25A	S: Sino-K P: SpO <sub>2</sub> 8: Adult soft (9: Adult clip; 7: Pediatric clip; 6: Pediatric soft; 5: Neonate wrap; 4: Multi Y; 3: Ear clip) 3: 3.0m (1: 1.0m) 25A: Philips 8 pins (25: Philips 12 pins; 19: Nellcor 7 pins; 19A: Nellcor 9 pins)
			
SpO <sub>2</sub> Adapter Cables 血氧转接线		SP 0 2 21B	S: Sino-K P: SpO <sub>2</sub> 0: SpO <sub>2</sub> Adapter Cables 2: 2.2m (1: 1.0m; 3: 3.0m) 21B: NIHON KOHDEN
Warranty: one-year warranty for reusable sensors and cables 保修：一年 包装：1个/包		Package: 1pcs/bag	



Armstrong Medical Reusable Sensors 重复性血氧探头

Models 监护仪型号	Connector 接头	Options 探头类型	Sino-K P/N 型号	OEM # 原装型号	Len. 长度
AD-900, 1000, 2000, 3000, 4000(BCI tech)	 SCN81	Adult clip 成人指夹	SP9303A		3m
		Adult soft 成人软指套	SP8303A		3m
		Pediatric clip 儿童指夹	SP7303A		3m
		Pediatric soft 儿童软指套	SP6303A		3m
		Neonate Wrap 新生儿包裹	SP5303A		3m
		Multi-Y 多功能Y型	SP4303A		3m
		Ear clip 成人耳夹	SP3303A		3m

Artema Reusable Sensors 阿体玛重复性血氧探头

Models 监护仪型号	Connector 接头	Options 探头类型	Sino-K P/N 型号	OEM # 原装型号	Len. 长度
Diascope	 SCN01	Adult clip 成人指夹	SP9301	SI033057	3m
		Adult soft 成人软指套	SP8301		3m
		Pediatric clip 儿童指夹	SP7301		3m
		Pediatric soft 儿童软指套	SP6301		3m
		Neonate Wrap 新生儿包裹	SP5301		3m
		Multi-Y 多功能Y型	SP4301		3m
		Ear clip 成人耳夹	SP3301		3m



Artema Reusable Sensors 阿体玛重复性血氧探头

Models 监护仪型号	Connector 接头	Options 探头类型	Sino-K P/N 型号	OEM # 原装型号	Len. 长度
S&W	 SCN02	Adult clip 成人指夹	SP9301A	SI033057	3m
		Adult soft 成人软指套	SP8301A		3m
		Pediatric clip 儿童指夹	SP7301A		3m
		Pediatric soft 儿童软指套	SP6301A		3m
		Neonate Wrap 新生儿包裹	SP5301A		3m
		Multi-Y 多功能Y型	SP4301A		3m
		Ear clip 成人耳夹	SP3301A		3m

Baxter/Simed Reusable Sensors 百特重复性血氧探头

Models 监护仪型号	Connector 接头	Options 探头类型	Sino-K P/N 型号	OEM # 原装型号	Len. 长度
ASAT S-50, S100, S-100e(Simed)	 SCN03	Adult clip 成人指夹	SP9302	600015	3m
		Adult soft 成人软指套	SP8302		3m
		Pediatric clip 儿童指夹	SP7302		3m
		Pediatric soft 儿童软指套	SP6302		3m
		Neonate Wrap 新生儿包裹	SP5302		3m
		Multi-Y 多功能Y型	SP4302		3m
		Ear clip 成人耳夹	SP3302		3m

BCI/Smiths Reusable Sensors 重复性血氧探头

Models 监护仪型号	Connector 接头	Options 探头类型	Sino-K P/N 型号	OEM # 原装型号	Len. 长度
3100, 3101, 6100, 9100, Advisor, Autocorr, Mini Torr, Mini Torr Plus	 SCP7	Adult clip 成人指夹	SP9303		3m
		Adult soft 成人软指套	SP8303		3m
		Pediatric clip 儿童指夹	SP7303		3m
		Pediatric soft 儿童软指套	SP6303		3m
		Neonate Wrap 新生儿包裹	SP5303		3m
		Multi-Y 多功能Y型	SP4303		3m
		Ear clip 成人耳夹	SP3303		3m
3300, 3301, 3302, 3303, 3304, 3401, 3180	 SCN81	Adult clip 成人指夹	SP9103A		1m
		Adult soft 成人软指套	SP8103A		1m
		Pediatric clip 儿童指夹	SP7103A		1m
		Pediatric soft 儿童软指套	SP6103A		1m
		Neonate Wrap 新生儿包裹	SP5103A		1m
		Multi-Y 多功能Y型	SP4103A		1m
Ear clip 成人耳夹	SP3103A		1m		

BCI/Smiths Reusable Sensors 重复性血氧探头

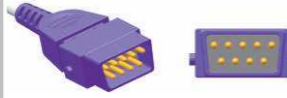
Models 监护仪型号	Connector 接头	Options 探头类型	Sino-K P/N 型号	OEM # 原装型号	Len. 长度
3300, 3301, 3302, 3303, 3304, 3401, 3180	 SCN81	成人指夹	SP9303A	3044/3444	3m
		Adult soft 成人软指套	SP8303A		3m
		Pediatric clip 儿童指夹	SP7303A		3m
		Pediatric soft 儿童软指套	SP6303A		3m
		Neonate Wrap 新生儿包裹	SP5303A	3025/3026	3m
		Multi-Y 多功能Y型	SP4303A	3043	3m
		Ear clip 成人耳夹	SP3303A		3m



Bionet Reusable Sensors 重复性血氧探头

Models 监护仪型号	Connector 接头	Options 探头类型	Sino-K P/N 型号	OEM # 原装型号	Len. 长度
	 SCN78	Adult clip 成人指夹	SP9306B		3m
		Adult soft 成人软指套	SP8306B		3m
		Pediatric clip 儿童指夹	SP7306B		3m
		Pediatric soft 儿童软指套	SP6306B		3m
		Neonate Wrap 新生儿包裹	SP5306B		3m
		Multi-Y 多功能Y型	SP4306B		3m
		Ear clip 成人耳夹	SP3306B		3m

Bionet Reusable Sensors 重复性血氧探头

Models 监护仪型号	Connector 接头	Options 探头类型	Sino-K P/N 型号	OEM # 原装型号	Len. 长度
	 SCP7-1	Adult clip 成人指夹	SP9306		3m
		Adult soft 成人软指套	SP8306		3m
		Pediatric clip 儿童指夹	SP7306		3m
		Pediatric soft 儿童软指套	SP6306		3m
		Neonate Wrap 新生儿包裹	SP5306		3m
		Multi-Y 多功能Y型	SP4306		3m
		Ear clip 成人耳夹	SP3306		3m
	 SCN63	Adult clip 成人指夹	SP9306A		3m
		Adult soft 成人软指套	SP8306A		3m
		Pediatric clip 儿童指夹	SP7306A		3m
		Pediatric soft 儿童软指套	SP6306A		3m
		Neonate Wrap 新生儿包裹	SP5306A		3m
		Multi-Y 多功能Y型	SP4306A		3m
		Ear clip 成人耳夹	SP3306A		3m



Biolight Reusable Sensors 宝莱特重复性血氧探头

Models 监护仪型号	Connector 接头	Options 探头类型	Sino-K P/N 型号	OEM # 原装型号	Len. 长度
	 SCP5	Adult clip 成人指夹	SP9305		3m
		Adult soft 成人软指套	SP8305		3m
		Pediatric clip 儿童指夹	SP7305		3m
		Pediatric soft 儿童软指套	SP6305		3m
		Neonate Wrap 新生儿包裹	SP5305		3m
		Multi-Y 多功能Y型	SP4305		3m
		Ear clip 成人耳夹	SP3305		3m
Biolight M69; M9000 Biocare Neusoft NSC-M10; Contec CSM9000, CSM6000 (Digital)	 SCP5	Adult clip 成人指夹	SP9305A		3m
		Adult soft 成人软指套	SP8305A		3m
		Pediatric clip 儿童指夹	SP7305A		3m
		Pediatric soft 儿童软指套	SP6305A		3m
		Neonate Wrap 新生儿包裹	SP5305A		3m
		Multi-Y 多功能Y型	SP4305A		3m
		Ear clip 成人耳夹	SP3305A		3m

**Biolight Reusable Sensors 宝莱特重复性血氧探头**

Models 监护仪型号	Connector 接头	Options 探头类型	Sino-K P/N 型号	OEM # 原装型号	Len. 长度
M700,M800 (Digital)	 SCN30	Adult clip 成人指夹	SP9105C		1m
		Adult soft 成人软指套	SP8105C		1m
		Pediatric clip 儿童指夹	SP7105C		1m
		Pediatric soft 儿童软指套	SP6105C		1m
		Neonate Wrap 新生儿包裹	SP5105C		1m
		Multi-Y 多功能Y型	SP4105C		1m
		Ear clip 成人耳夹	SP3105C		1m
		M7000 (Digital)	 SCN61	Adult clip 成人指夹	SP9305D
Adult soft 成人软指套	SP8305D				3m
Pediatric clip 儿童指夹	SP7305D				3m
Pediatric soft 儿童软指套	SP6305D				3m
Neonate Wrap 新生儿包裹	SP5305D				3m
Multi-Y 多功能Y型	SP4305D				3m
Ear clip 成人耳夹	SP3305D				3m
(Digital)	 SCN62			Adult clip 成人指夹	SP9305E
		Adult soft 成人软指套	SP8305E		3m
		Pediatric clip 儿童指夹	SP7305E		3m
		Pediatric soft 儿童软指套	SP6305E		3m
		Neonate Wrap 新生儿包裹	SP5305E		3m
		Multi-Y 多功能Y型	SP4305E		3m
		Ear clip 成人耳夹	SP3305E		3m

**Biolight Reusable Sensors 宝莱特重复性血氧探头**

Models 监护仪型号	Connector 接头	Options 探头类型	Sino-K P/N 型号	OEM # 原装型号	Len. 长度
(Nellcor Oximax)	 SCN61	Adult clip 成人指夹	SP9305F		3m
		Adult soft 成人软指套	SP8305F		3m
		Pediatric clip 儿童指夹	SP7305F		3m
		Pediatric soft 儿童软指套	SP6305F		3m
		Neonate Wrap 新生儿包裹	SP5305F		3m
		Multi-Y 多功能Y型	SP4305F		3m
		Ear clip 成人耳夹	SP3305F		3m
		A8,M9000 (Digital)	 SCN82	Adult clip 成人指夹	SP9305H
Adult soft 成人软指套	SP8305H				3m
Pediatric clip 儿童指夹	SP7305H				3m
Pediatric soft 儿童软指套	SP6305H				3m
Neonate Wrap 新生儿包裹	SP5305H				3m
Multi-Y 多功能Y型	SP4305H				3m
Ear clip 成人耳夹	SP3305H				3m

**Biosys Reusable Sensors 重复性血氧探头**

Models 监护仪型号	Connector 接头	Options 探头类型	Sino-K P/N 型号	OEM # 原装型号	Len. 长度
BPM-200, Vital Sign Monitor SENTRY	 SCN05	Adult clip 成人指夹	SP9304		3m
		Adult soft 成人软指套	SP8304		3m
		Pediatric clip 儿童指夹	SP7304		3m
		Pediatric soft 儿童软指套	SP6304		3m
		Neonate Wrap 新生儿包裹	SP5304		3m
		Multi-Y 多功能Y型	SP4304		3m
		Ear clip 成人耳夹	SP3304		3m



CAS Medical Reusable Sensors 重复性血氧探头

Models 监护仪型号	Connector 接头	Options 探头类型	Sino-K P/N 型号	OEM # 原装型号	Len. 长度
OscilloMate 9002, 9303, 9302S(Nonin tech)	 SCN83	Adult clip 成人指夹	SP9322B		3m
		Adult soft 成人软指套	SP8322B		3m
		Pediatric clip 儿童指夹	SP7322B		3m
		Pediatric soft 儿童软指套	SP6322B		3m
		Neonate Wrap 新生儿包裹	SP5322B		3m
		Multi-Y 多功能Y型	SP4322B		3m
		Ear clip 成人耳夹	SP3322B		3m
		740-750(Masim tech)	 SCN22	Adult clip 成人指夹	SP9315
Adult soft 成人软指套	SP8315			3m	
Pediatric clip 儿童指夹	SP7315			3m	
Pediatric soft 儿童软指套	SP6315			3m	
Neonate Wrap 新生儿包裹	SP5315			3m	
Multi-Y 多功能Y型	SP4315			3m	
Ear clip 成人耳夹	SP3315			3m	

Charmcare Reusable Sensors 重复性血氧探头

Models 监护仪型号	Connector 接头	Options 探头类型	Sino-K P/N 型号	OEM # 原装型号	Len. 长度
CX100(Nellcor tech)	 SCN30	Adult clip 成人指夹	SP9319		3m
		Adult soft 成人软指套	SP8319		3m
		Pediatric clip 儿童指夹	SP7319		3m
		Pediatric soft 儿童软指套	SP6319		3m
		Neonate Wrap 新生儿包裹	SP5319		3m
		Multi-Y 多功能Y型	SP4319		3m
		Ear clip 成人耳夹	SP3319		3m

Choice Electronic Reusable Sensors 超思重复性血氧探头

Models 监护仪型号	Connector 接头	Options 探头类型	Sino-K P/N 型号	OEM # 原装型号	Len. 长度
M3	 SCP6	Adult clip 成人指夹	SP9342		3m
		Adult soft 成人软指套	SP8342		3m
		Pediatric clip 儿童指夹	SP7342		3m
		Pediatric soft 儿童软指套	SP6342		3m
		Neonate Wrap 新生儿包裹	SP5342		3m
		Multi-Y 多功能Y型	SP4342		3m
		Ear clip 成人耳夹	SP3342		3m
		(Digital)	 SCP6	Adult clip 成人指夹	SP9342A
Adult soft 成人软指套	SP8342A			3m	
Pediatric clip 儿童指夹	SP7342A			3m	
Pediatric soft 儿童软指套	SP6342A			3m	
Neonate Wrap 新生儿包裹	SP5342A			3m	
Multi-Y 多功能Y型	SP4342A			3m	
Ear clip 成人耳夹	SP3342A			3m	

Colin Reusable Sensors 科林重复性血氧探头

Models 监护仪型号	Connector 接头	Options 探头类型	Sino-K P/N 型号	OEM # 原装型号	Len. 长度
BP88/306/508/608 /BX10ne(Nellcor tech)	 SCN30	Adult clip 成人指夹	SP9319		3m
		Adult soft 成人软指套	SP8319		3m
		Pediatric clip 儿童指夹	SP7319		3m
		Pediatric soft 儿童软指套	SP6319		3m
		Neonate Wrap 新生儿包裹	SP5319		3m
		Multi-Y 多功能Y型	SP4319		3m
		Ear clip 成人耳夹	SP3319		3m



Colin Reusable Sensors 科林重复性血氧探头

Models 监护仪型号	Connector 接头	Options 探头类型	Sino-K P/N 型号	OEM # 原装型号	Len. 长度
BP 88S	 SCN22	成人指夹	SP9319B		3m
		Adult soft 成人软指套	SP8319B		3m
		Pediatric clip 儿童指夹	SP7319B		3m
		Pediatric soft 儿童软指套	SP6319B		3m
		Neonate Wrap 新生儿包裹	SP5319B		3m
		Multi-Y 多功能Y型	SP4319B		3m
		Ear clip 成人耳夹	SP3319B		3m
		BX10ma(Masim tech)	 SCN22	Adult clip 成人指夹	SP9315
Adult soft 成人软指套	SP8315				1m
Pediatric clip 儿童指夹	SP7315				1m
Pediatric soft 儿童软指套	SP6315				1m
Neonate Wrap 新生儿包裹	SP5315				1m
Multi-Y 多功能Y型	SP4315				1m
Ear clip 成人耳夹	SP3315				1m



Comen Reusable Sensors 科曼重复性血氧探头

Models 监护仪型号	Connector 接头	Options 探头类型	Sino-K P/N 型号	OEM # 原装型号	Len. 长度
CM8000A	 SCP6	Adult clip 成人指夹	SP9361		3m
		Adult soft 成人软指套	SP8361		3m
		Pediatric clip 儿童指夹	SP7361		3m
		Pediatric soft 儿童软指套	SP6361		3m
		Neonate Wrap 新生儿包裹	SP5361		3m
		Multi-Y 多功能Y型	SP4361		3m
		Ear clip 成人耳夹	SP3361		3m



Comen Reusable Sensors 科曼重复性血氧探头

Models 监护仪型号	Connector 接头	Options 探头类型	Sino-K P/N 型号	OEM # 原装型号	Len. 长度
(Digital)	 SCP6	Adult clip 成人指夹	SP9361A		3m
		Adult soft 成人软指套	SP8361A		3m
		Pediatric clip 儿童指夹	SP7361A		3m
		Pediatric soft 儿童软指套	SP6361A		3m
		Neonate Wrap 新生儿包裹	SP5361A		3m
		Multi-Y 多功能Y型	SP4361A		3m
		Ear clip 成人耳夹	SP3361A		3m
		(Digital)	 SCP6R	Adult clip 成人指夹	SP9361B
Adult soft 成人软指套	SP8361B				3m
Pediatric clip 儿童指夹	SP7361B				3m
Pediatric soft 儿童软指套	SP6361B				3m
Neonate Wrap 新生儿包裹	SP5361B				3m
Multi-Y 多功能Y型	SP4361B				3m
Ear clip 成人耳夹	SP3361B				3m
(Digital)	 SCP6R			Adult clip 成人指夹	SP9361C
		Adult soft 成人软指套	SP8361C		3m
		Pediatric clip 儿童指夹	SP7361C		3m
		Pediatric soft 儿童软指套	SP6361C		3m
		Neonate Wrap 新生儿包裹	SP5361C		3m
		Multi-Y 多功能Y型	SP4361C		3m
		Ear clip 成人耳夹	SP3361C		3m

Comen Reusable Sensors 科曼重复性血氧探头

Models 监护仪型号	Connector 接头	Options 探头类型	Sino-K P/N 型号	OEM # 原装型号	Len. 长度
Oximax	 SCP8R-R	Adult clip 成人指夹	SP9361D		3m
		Adult soft 成人软指套	SP8361D		3m
		Pediatric clip 儿童指夹	SP7361D		3m
		Pediatric soft 儿童软指套	SP6361D		3m
		Neonate Wrap 新生儿包裹	SP5361D		3m
		Multi-Y 多功能Y型	SP4361D		3m
		Ear clip 成人耳夹	SP3361D		3m
		C70 C90	 SCN96	Adult clip 成人指夹	SP9361H
Adult soft 成人软指套	SP8361H				3m
Pediatric clip 儿童指夹	SP7361H				3m
Pediatric soft 儿童软指套	SP6361H				3m
Neonate Wrap 新生儿包裹	SP5361H				3m
Multi-Y 多功能Y型	SP4361H				3m
Ear clip 成人耳夹	SP3361H				3m

CSI Reusable Sensors 重复性血氧探头

Models 监护仪型号	Connector 接头	Options 探头类型	Sino-K P/N 型号	OEM # 原装型号	Len. 长度
501,503,504,507,508,581, 1100,8100,Poet(602-3A), Scholar	 SCM5	Adult clip 成人指夹	SP9307	934-10LN	3m
		Adult soft 成人软指套	SP8307	975AD-10L	3m
		Pediatric clip 儿童指夹	SP7307	1563-10L	3m
		Pediatric soft 儿童软指套	SP6307	975PD-10L	3m
		Neonate Wrap 新生儿包裹	SP5307		3m
		Multi-Y 多功能Y型	SP4307	940-10L	3m
		Ear clip 成人耳夹	SP3307	1567-10L	3m
		503 Spot, 504Plus, 504DX, 506DXN 90 degree angle	 SCN06	Adult clip 成人指夹	SP9307A
Adult soft 成人软指套	SP8307A			975AD-10	3m
Pediatric clip 儿童指夹	SP7307A			1563-10D	3m
Pediatric soft 儿童软指套	SP6307A			975PD-10	3m
Neonate Wrap 新生儿包裹	SP5307A				3m
Multi-Y 多功能Y型	SP4307A			940-10D	3m
Ear clip 成人耳夹	SP3307A			1567-10D	3m

CSI Reusable Sensors 重复性血氧探头

Models 监护仪型号	Connector 接头	Options 探头类型	Sino-K P/N 型号	OEM # 原装型号	Len. 长度
90 degree angle	 SCN06	Adult clip 成人指夹	SP9107A	934SDN	1m
		Adult soft 成人软指套	SP8107A	975AD-3	1m
		Pediatric clip 儿童指夹	SP7107A	1563-SD	1m
		Pediatric soft 儿童软指套	SP6107A	975PD-3	1m
		Neonate Wrap 新生儿包裹	SP5107A		1m
		Multi-Y 多功能Y型	SP4107A	940SD	1m
		Ear clip 成人耳夹	SP3107A	1567SD	1m



Dolphin Reusable Sensors 海豚重复性血氧探头

Models 监护仪型号	Connector 接头	Options 探头类型	Sino-K P/N 型号	OEM # 原装型号	Len. 长度
2100, 2150 (Digital)	 SCN71	Adult clip 成人指夹	SP9162A		1m
		Adult soft 成人软指套	SP8162A		1m
		Pediatric clip 儿童指夹	SP7162A		1m
		Pediatric soft 儿童软指套	SP6162A		1m
		Neonate Wrap 新生儿包裹	SP5162A		1m
		Multi-Y 多功能Y型	SP4162A		1m
		Ear clip 成人耳夹	SP3162A		1m

Dolphin Reusable Sensors 海豚重复性血氧探头

Models 监护仪型号	Connector 接头	Options 探头类型	Sino-K P/N 型号	OEM # 原装型号	Len. 长度
2100, 2150 (Digital)	 SCN22	Adult clip 成人指夹	SP9362		3m
		Adult soft 成人软指套	SP8362		3m
		Pediatric clip 儿童指夹	SP7362		3m
		Pediatric soft 儿童软指套	SP6362		3m
		Neonate Wrap 新生儿包裹	SP5362		3m
		Multi-Y 多功能Y型	SP4362		3m
		Ear clip 成人耳夹	SP3362		3m

Drager-Siemens Reusable Sensors 德尔格-西门子重复性血氧探头

Models 监护仪型号	Connector 接头	Options 探头类型	Sino-K P/N 型号	OEM # 原装型号	Len. 长度
Vitalert 1000, Cicero, GammaXL, DeltaXL, Kappa	 SCM8	Adult clip 成人指夹	SP9309		3m
		Adult soft 成人软指套	SP8309		3m
		Pediatric clip 儿童指夹	SP7309		3m
		Pediatric soft 儿童软指套	SP6309		3m
		Neonate Wrap 新生儿包裹	SP5309		3m
		Multi-Y 多功能Y型	SP4309		3m
		Ear clip 成人耳夹	SP3309		3m
Sirecust, Sirem Spo2	 SCN09	Adult clip 成人指夹	SP9309A		3m
		Adult soft 成人软指套	SP8309A		3m
		Pediatric clip 儿童指夹	SP7309A		3m
		Pediatric soft 儿童软指套	SP6309A		3m
		Neonate Wrap 新生儿包裹	SP5309A		3m
		Multi-Y 多功能Y型	SP4309A		3m
		Ear clip 成人耳夹	SP3309A		3m

Drager-Siemens Reusable Sensors 德尔格-西门子重复性血氧探头

Models 监护仪型号	Connector 接头	Options 探头类型	Sino-K P/N 型号	OEM # 原装型号	Len. 长度
SC6000, 7000,9000	 SCN10	Adult clip 成人指夹	SP9309B		3m
		Adult soft 成人软指套	SP8309B		3m
		Pediatric clip 儿童指夹	SP7309B		3m
		Pediatric soft 儿童软指套	SP6309B		3m
		Neonate Wrap 新生儿包裹	SP5309B		3m
		Multi-Y 多功能Y型	SP4309B		3m
		Ear clip 成人耳夹	SP3309B		3m

GE-Corometrics Reusable Sensors 科洛重复性血氧探头

Models 监护仪型号	Connector 接头	Options 探头类型	Sino-K P/N 型号	OEM # 原装型号	Len. 长度
Corometrics 120, 510, 511, 118,556	 SCN11	Adult clip 成人指夹	SP9310		3m
		Adult soft 成人软指套	SP8310		3m
		Pediatric clip 儿童指夹	SP7310		3m
		Pediatric soft 儿童软指套	SP6310		3m
		Neonate Wrap 新生儿包裹	SP5310		3m
		Multi-Y 多功能Y型	SP4310		3m
		Ear clip 成人耳夹	SP3310		3m

GE-Critikon Reusable Sensors 强生重复性血氧探头

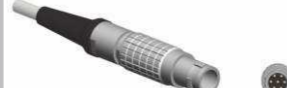
Models 监护仪型号	Connector 接头	Options 探头类型	Sino-K P/N 型号	OEM # 原装型号	Len. 长度
Dinamap 8700/8710 /8720 Plus, Oxysuttle	 SCM7	Adult clip 成人指夹	SP9310A		3m
		Adult soft 成人软指套	SP8310A		3m
		Pediatric clip 儿童指夹	SP7310A		3m
		Pediatric soft 儿童软指套	SP6310A		3m
		Neonate Wrap 新生儿包裹	SP5310A		3m
		Multi-Y 多功能Y型	SP4310A		3m
		Ear clip 成人耳夹	SP3310A		3m

GE-Critikon Reusable Sensors 强生重复性血氧探头

Models 监护仪型号	Connector 接头	Options 探头类型	Sino-K P/N 型号	OEM # 原装型号	Len. 长度
Dinamap 9700 / 9710 / 9720, Plus, Compact, MPS, Select	 SCN30	Adult clip 成人指夹			
		Adult soft 成人软指套	SP8319		3m
		Pediatric clip 儿童指夹	SP7319		3m
		Pediatric soft 儿童软指套	SP6319		3m
		Neonate Wrap 新生儿包裹	SP5319		3m
		Multi-Y 多功能Y型	SP4319		3m
		Ear clip 成人耳夹	SP3319		3m
		Dinamap ProSeries V1 and Pro 1000 V2 (Nellcor tech)	 SCN22	Adult clip 成人指夹	SP9319B
Adult soft 成人软指套	SP8319B			3m	
Pediatric clip 儿童指夹	SP7319B			3m	
Pediatric soft 儿童软指套	SP6319B			3m	
Neonate Wrap 新生儿包裹	SP5319B			3m	
Multi-Y 多功能Y型	SP4319B			3m	
Ear clip 成人耳夹	SP3319B			3m	
ProCare; ProSeries V2; Pro 1000 V3(Masim)	 SCN22	Adult clip 成人指夹	SP9315		3m
		Adult soft 成人软指套	SP8315		3m
		Pediatric clip 儿童指夹	SP7315		3m
		Pediatric soft 儿童软指套	SP6315		3m
		Neonate Wrap 新生儿包裹	SP5315		3m
		Multi-Y 多功能Y型	SP4315		3m
		Ear clip 成人耳夹	SP3315		3m

GE-Datex Ohmeda Reusable Sensors 德思重复性血氧探头

Models 监护仪型号	Connector 接头	Options 探头类型	Sino-K P/N 型号	OEM # 原装型号	Len. 长度		
S/5, AS/3, CS/3 Modular Monitors; with M-series modules; Cardiocap/5, Cardiocap S/5 Light Monitor; Capnomac Ultima Satlite Plus II	 SCN12	Adult clip 成人指夹	SP9310B	OXY-F4-N	3m		
		Adult soft 成人软指套	SP8310B		3m		
		Pediatric clip 儿童指夹	SP7310B		3m		
		Pediatric soft 儿童软指套	SP6310B		3m		
		Neonate Wrap 新生儿包裹	SP5310B		3m		
		Multi-Y 多功能Y型	SP4310B		3m		
		Ear clip 成人耳夹	SP3310B	OXY-E4-N	3m		
		E-NSAT Modules for i4 Modular Monitors	 SCN31	Adult clip 成人指夹	SP9119A		1m
		Adult soft 成人软指套		SP8119A		1m	
Pediatric clip 儿童指夹	SP7119A			1m			
Pediatric soft 儿童软指套	SP6119A			1m			
Neonate Wrap 新生儿包裹	SP5119A			1m			
Multi-Y 多功能Y型	SP4119A			1m			
Ear clip 成人耳夹	SP3119A			1m			
S/5, AS/3, CS/3 Modular Monitors; with M-series modules; Cardiocap/5, Cardiocap S/5 Light Monitor; Capnomac Ultima Satlite Plus II	 SCN04	Adult clip 成人指夹	SP9110C	OXY-F-DB	1m		
		Adult soft 成人软指套	SP8110C		1m		
		Pediatric clip 儿童指夹	SP7110C		1m		
		Pediatric soft 儿童软指套	SP6110C		1m		
		Neonate Wrap 新生儿包裹	SP5110C	OXY-W-DB	1m		
		Multi-Y 多功能Y型	SP4110C		1m		
		Ear clip 成人耳夹	SP3110C	OXY-E-DB	1m		



GE-Datex Ohmeda Reusable Sensors 德思重复性血氧探头

Models 监护仪型号	Connector 接头	Options 探头类型	Sino-K P/N 型号	OEM # 原装型号	Len. 长度
M-NSAT Modules for AS/3, CS/3,S/5 Modular	 SCN22	Adult clip 成人指夹	SP9319B		3m
		Adult soft 成人软指套	SP8319B		3m
		Pediatric clip 儿童指夹	SP7319B		3m
		Pediatric soft 儿童软指套	SP6319B		3m
		Neonate Wrap 新生儿包裹	SP5319B		3m
		Multi-Y 多功能Y型	SP4319B		3m
		Ear clip 成人耳夹	SP3319B		3m

GE-Hellige Reusable Sensors 海力格重复性血氧探头

Models 兼容型号	Connector 接头	Options 探头	Sino-k P/N 型号	OEM # 原装	Len. 长度
Eagle 1000, 3000, SMU, SMK, SMV, cardioserv	 SCN13	Adult clip 成人指夹	SP9310D		3m
		Adult soft 成人软指套	SP8310D		3m
		Pediatric clip 儿童指夹	SP7310D		3m
		Pediatric soft 儿童软指套	SP6310D		3m
		Neonate Wrap 新生儿包裹	SP5310D		3m
		Multi-Y 多功能Y型	SP4310D		3m
		Ear clip 成人耳夹	SP3310D		3m



GE-Ohmeda Reusable Sensors 欧美达重复性血氧探头

Models 监护仪型号	Connector 接头	Options 探头类型	Sino-K P/N 型号	OEM # 原装型号	Len. 长度
Ohmeda TuffSat;3775, 37xx Series, 3800, 3900, 3900P, 4700 and 5250 respiratory gas monitors;Cardiocap/5	 SCN16	Adult clip 成人指夹	SP9310H	OXY-F4-H	3m
		Adult soft 成人软指套	SP8310H		3m
		Pediatric clip 儿童指夹	SP7310H		3m
		Pediatric soft 儿童软指套	SP6310H		3m
		Neonate Wrap 新生儿包裹	SP5310H	OXY-W4-H	3m
		Multi-Y 多功能Y型	SP4310H		3m
		Ear clip 成人耳夹	SP3310H	OXY-E4-H	3m



GE-Ohmeda Reusable Sensors 欧美达重复性血氧探头

Models 监护仪型号	Connector 接头	Options 探头类型	Sino-K P/N 型号	OEM # 原装型号	Len. 长度
	 SCN04	Adult clip 成人指夹	SP9110J		1m
		Adult soft 成人软指套	SP8110J		1m
		Pediatric clip 儿童指夹	SP7110J		1m
		Pediatric soft 儿童软指套	SP6110J		1m
		Neonate Wrap 新生儿包裹	SP5110J		1m
		Multi-Y 多功能Y型	SP4110J		1m
		Ear clip 成人耳夹	SP3110J		1m
		Ohmeda TuffSat	 SCN16	Adult clip 成人指夹	SP9110H
Adult soft 成人软指套	SP8110H				1m
Pediatric clip 儿童指夹	SP7110H				1m
Pediatric soft 儿童软指套	SP6110H				1m
Neonate Wrap 新生儿包裹	SP5110H				1m
Multi-Y 多功能Y型	SP4110H				1m
Ohmeda TruSat, Ohmeda TruSat TD	 SCN18	Adult clip 成人指夹	SP9310M	OXY-F4-MC	3m
		Adult soft 成人软指套	SP8310M		3m
		Pediatric clip 儿童指夹	SP7310M		3m
		Pediatric soft 儿童软指套	SP6310M		3m
		Neonate Wrap 新生儿包裹	SP5310M		3m
		Multi-Y 多功能Y型	SP4310M		3m
		Ear clip 成人耳夹	SP3310M	OXY-E4-MC	3m

GE-Datex Ohmeda Reusable Sensors 德思重复性血氧探头

Models 监护仪型号	Connector 接头	Options 探头类型	Sino-K P/N 型号	OEM # 原装型号	Len. 长度
S/5, i4 Modular Monitors with E-series modules; Corometrics 259 with TruSignal(Ohmeda tech) B20/30/40 Series	 SCN15	Adult clip 成人指夹	SP9310K	OXY-F4-GE	3m
		Adult soft 成人软指套	SP8310K		3m
		Pediatric clip 儿童指夹	SP7310K		3m
		Pediatric soft 儿童软指套	SP6310K		3m
		Neonate Wrap 新生儿包裹	SP5310K		3m
		Multi-Y 多功能Y型	SP4310K		3m
		Ear clip 成人耳夹	SP3310K		3m
GE-Ohmeda OxyTip sensor	 SCN17	Adult clip 成人指夹	SP9110L	OXY-F4-UN	1m
		Adult soft 成人软指套	SP8110L		1m
		Pediatric clip 儿童指夹	SP7110L		1m
		Pediatric soft 儿童软指套	SP6110L		1m
		Neonate Wrap 新生儿包裹	SP5110L	OXY-W-UN	1m
		Multi-Y 多功能Y型	SP4110L	OXY-SE-3	1m
		Ear clip 成人耳夹	SP3110L		1m

GE-Marquette Reusable Sensors 马奎重复性血氧探头

Models 监护仪型号	Connector 接头	Options 探头类型	Sino-K P/N 型号	OEM # 原装型号	Len. 长度
Dash 3000/4000/5000 (OxiMax); Solar 8000/8000M, i9500 with Tram module 451N5/851N5; Dash 3000/4000/5000(OxiMax); Solar 8000/8000M, i9500 with Tram module 451N5/851N5	 SCN15	Adult clip 成人指夹	SP9310F		3m
		Adult soft 成人软指套	SP8310F		3m
		Pediatric clip 儿童指夹	SP7310F		3m
		Pediatric soft 儿童软指套	SP6310F		3m
		Neonate Wrap 新生儿包裹	SP5310F		3m
		Multi-Y 多功能Y型	SP4310F		3m
		Ear clip 成人耳夹	SP3310F		3m
Dash 3000/4000/5000 (Masim) Solar 8000/8000M, i9500 with Tram Module 451M/851M CardioLab /Mac-Lab with Tram Module 451M; Corometrics 259(Masim)	 SCN15	Adult clip 成人指夹	SP9310G		3m
		Adult soft 成人软指套	SP8310G		3m
		Pediatric clip 儿童指夹	SP7310G		3m
		Pediatric soft 儿童软指套	SP6310G		3m
		Neonate Wrap 新生儿包裹	SP5310G		3m
		Multi-Y 多功能Y型	SP4310G		3m
		Ear clip 成人耳夹	SP3310G		3m

GE-Marquette Reusable Sensors 马奎重复性血氧探头

Models 监护仪型号	Connector 接头	Options 探头类型	Sino-K P/N 型号	OEM # 原装型号	Len. 长度
Dash 2000/3000/4000(Nellcor); Solar 8000/8000M, i9500 with Tram Module 451/451N/851/851N; CardioLab /Mac-Lab with Tram Module 451/451N; Corometrics 120/2120 series; Eagle 1000/3000/4000; Responder 3000 (Nellcor tech)	 SCN14	Adult clip 成人指夹	SP9310E		3m
		Adult soft 成人软指套	SP8310E		3m
		Pediatric clip 儿童指夹	SP7310E		3m
		Pediatric soft 儿童软指套	SP6310E		3m
		Neonate Wrap 新生儿包裹	SP5310E		3m
		Multi-Y 多功能Y型	SP4310E		3m
		Ear clip 成人耳夹	SP3310E		3m

GE TruSignal Reusable Sensors 重复性血氧探头

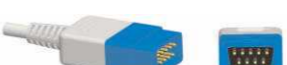
Models 监护仪型号	Connector 接头	Options 探头类型	Sino-K P/N 型号	OEM # 原装型号	Len. 长度
TruSignal sensor	 SCN64	Adult clip 成人指夹	SP9110S	TS-F-D	1m
		Adult soft 成人软指套	SP8110S	TS-SA-D	1m
		Pediatric clip 儿童指夹	SP7110S		1m
		Pediatric soft 儿童软指套	SP6110S	TS-SP-D	1m
		Neonate Wrap 新生儿包裹	SP5110S	TS-W-D	1m
		Multi-Y 多功能Y型	SP4110S	TS-SE-3	1m
		Ear clip 成人耳夹			

GE Trusignal Reusable Sensors 重复性血氧探头

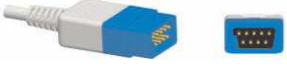
Models 监护仪型号	Connector 接头	Options 探头类型	Sino-K P/N 型号	OEM # 原装型号	Len. 长度
	 SCN74	Adult clip 成人指夹			
		Adult soft 成人软指套			
		Pediatric clip 儿童指夹			
		Pediatric soft 儿童软指套			
		Neonate Wrap 新生儿包裹			
		Multi-Y 多功能Y型			
		Ear clip 成人耳夹	SP3110T	TS-E-D	1m

Goldway Reusable Sensors 金科威重复性血氧探头

Models 监护仪型号	Connector 接头	Options 探头类型	Sino-K P/N 型号	OEM # 原装型号	Len. 长度
940	 SCM5	Adult clip 成人指夹	SP9311		3m
		Adult soft 成人软指套	SP8311		3m
		Pediatric clip 儿童指夹	SP7311		3m
		Pediatric soft 儿童软指套	SP6311		3m
		Neonate Wrap 新生儿包裹	SP5311		3m
		Multi-Y 多功能Y型	SP4311		3m
		Ear clip 成人耳夹	SP3311		3m
		南京世帝;深迈900F; 科力威;思创7000C; 宏润达 EM6/EM7	 SCP5	Adult clip 成人指夹	SP9311A
Adult soft 成人软指套	SP8311A				3m
Pediatric clip 儿童指夹	SP7311A				3m
Pediatric soft 儿童软指套	SP6311A				3m
Neonate Wrap 新生儿包裹	SP5311A				3m
Multi-Y 多功能Y型	SP4311A				3m
Ear clip 成人耳夹	SP3311A				3m

Goldway Reusable Sensors 金科威重复性血氧探头

Models 监护仪型号	Connector 接头	Options 探头类型	Sino-K P/N 型号	OEM # 原装型号	Len. 长度
	 SCP7	Adult clip 成人指夹	SP9311B		3m
		Adult soft 成人软指套	SP8311B		3m
		Pediatric clip 儿童指夹	SP7311B		3m
		Pediatric soft 儿童软指套	SP6311B		3m
		Neonate Wrap 新生儿包裹	SP5311B		3m
		Multi-Y 多功能Y型	SP4311B		3m
		Ear clip 成人耳夹	SP3311B		3m



Guoteng Reusable Sensors 珠海国腾重复性血氧探头

Models 监护仪型号	Connector 接头	Options 探头类型	Sino-K P/N 型号	OEM # 原装型号	Len. 长度
	 SCP6	Adult clip 成人指夹	SP9350		3m
		Adult soft 成人软指套	SP8350		3m
		Pediatric clip 儿童指夹	SP7350		3m
		Pediatric soft 儿童软指套	SP6350		3m
		Neonate Wrap 新生儿包裹	SP5350		3m
		Multi-Y 多功能Y型	SP4350		3m
		Ear clip 成人耳夹	SP3350		3m

Infinium Reusable Sensors 重复性血氧探头

Models 监护仪型号	Connector 接头	Options 探头类型	Sino-K P/N 型号	OEM # 原装型号	Len. 长度
OMNI 2, OMNI 3; 武汉思创 (Digital)	 SCP5R	Adult clip 成人指夹	SP9365		3m
		Adult soft 成人软指套	SP8365		3m
		Pediatric clip 儿童指夹	SP7365		3m
		Pediatric soft 儿童软指套	SP6365		3m
		Neonate Wrap 新生儿包裹	SP5365		3m
		Multi-Y 多功能Y型	SP4365		3m
		Ear clip 成人耳夹	SP3365		3m

Infinium Reusable Sensors 重复性血氧探头

Models 监护仪型号	Connector 接头	Options 探头类型	Sino-K P/N 型号	OEM # 原装型号	Len. 长度
OMNI(BCI Tech)	 SCP6	Adult clip 成人指夹	SP9365A		3m
		Adult soft 成人软指套	SP8365A		3m
		Pediatric clip 儿童指夹	SP7365A		3m
		Pediatric soft 儿童软指套	SP6365A		3m
		Neonate Wrap 新生儿包裹	SP5365A		3m
		Multi-Y 多功能Y型	SP4365A		3m
		Ear clip 成人耳夹	SP3365A		3m
	 SCN93	Adult clip 成人指夹	SP9361G		3m
		Adult soft 成人软指套	SP8361G		3m
		Pediatric clip 儿童指夹	SP7361G		3m
		Pediatric soft 儿童软指套	SP6361G		3m
		Neonate Wrap 新生儿包裹	SP5361G		3m
		Multi-Y 多功能Y型	SP4361G		3m
Ear clip 成人耳夹	SP3361G		3m		

Invivo Reusable Sensors 英威重复性血氧探头

Models 监护仪型号	Connector 接头	Options 探头类型	Sino-K P/N 型号	OEM # 原装型号	Len. 长度
4500, 4500 Plus, Millenia, Omega 1445, Omni-Trak TVS, Sat Scout, 4500 Plus 2	 SCM7	Adult clip 成人指夹	SP9312		3m
		Adult soft 成人软指套	SP8312		3m
		Pediatric clip 儿童指夹	SP7312		3m
		Pediatric soft 儿童软指套	SP6312		3m
		Neonate Wrap 新生儿包裹	SP5312		3m
		Multi-Y 多功能Y型	SP4312		3m
		Ear clip 成人耳夹	SP3312		3m

Invivo Reusable Sensors 英威重复性血氧探头

Models 监护仪型号	Connector 接头	Options 探头类型	Sino-K P/N 型号	OEM # 原装型号	Len. 长度
New generation(Masim)	 SCM7	Adult clip 成人指夹	SP9312A		3m
		Adult soft 成人软指套	SP8312A		3m
		Pediatric clip 儿童指夹	SP7312A		3m
		Pediatric soft 儿童软指套	SP6312A		3m
		Neonate Wrap 新生儿包裹	SP5312A		3m
		Multi-Y 多功能Y型	SP4312A		3m
		Ear clip 成人耳夹	SP3312A		3m



Ivy Biomedical Reusable Sensors 重复性血氧探头

Models 监护仪型号	Connector 接头	Options 探头类型	Sino-K P/N 型号	OEM # 原装型号	Len. 长度
Vital-Guard 450C	 SCN22	Adult clip 成人指夹	SP9315		3m
		Adult soft 成人软指套	SP8315		3m
		Pediatric clip 儿童指夹	SP7315		3m
		Pediatric soft 儿童软指套	SP6315		3m
		Neonate Wrap 新生儿包裹	SP5315		3m
		Multi-Y 多功能Y型	SP4315		3m
		Ear clip 成人耳夹	SP3315		3m

Jeteem Reusable Sensors 井田医电重复性血氧探头

Models 监护仪型号	Connector 接头	Options 探头类型	Sino-K P/N 型号	OEM # 原装型号	Len. 长度
BD9000	 SCP6R	Adult clip 成人指夹	SP9349		3m
		Adult soft 成人软指套	SP8349		3m
		Pediatric clip 儿童指夹	SP7349		3m
		Pediatric soft 儿童软指套	SP6349		3m
		Neonate Wrap 新生儿包裹	SP5349		3m
		Multi-Y 多功能Y型	SP4349		3m
		Ear clip 成人耳夹	SP3349		3m

Kontron Reusable Sensors 康强重复性血氧探头

Models 监护仪型号	Connector 接头	Options 探头类型	Sino-K P/N 型号	OEM # 原装型号	Len. 长度
7840, 7845, Minimon 7137, Micromon, Supermon, Kolormon, Trakmon	 SCN20	Adult clip 成人指夹	SP9313	0608010	3m
		Adult soft 成人软指套	SP8313		3m
		Pediatric clip 儿童指夹	SP7313		3m
		Pediatric soft 儿童软指套	SP6313		3m
		Neonate Wrap 新生儿包裹	SP5313		3m
		Multi-Y 多功能Y型	SP4313		3m
		Ear clip 成人耳夹	SP3313		3m
		7 pins 80 degree	 SCP7T	Adult clip 成人指夹	SP9313A
Adult soft 成人软指套	SP8313A			3m	
Pediatric clip 儿童指夹	SP7313A			3m	
Pediatric soft 儿童软指套	SP6313A			3m	
Neonate Wrap 新生儿包裹	SP5313A			3m	
Multi-Y 多功能Y型	SP4313A			3m	
Ear clip 成人耳夹	SP3313A			3m	

Masim Reusable Sensors 迈心诺重复性血氧探头

Models 监护仪型号	Connector 接头	Options 探头类型	Sino-K P/N 型号	OEM # 原装型号	Len. 长度
	 SCN22	Adult clip 成人指夹	SP9315	1396/1969	3m
		Adult soft 成人软指套	SP8315		3m
		Pediatric clip 儿童指夹	SP7315		3m
		Pediatric soft 儿童软指套	SP6315		3m
		Neonate Wrap 新生儿包裹	SP5315		3m
		Multi-Y 多功能Y型	SP4315		3m
		Ear clip 成人耳夹	SP3315		3m

Masim Reusable Sensors 迈心诺重复性血氧探头

Models 监护仪型号	Connector 接头	Options 探头类型	Sino-K P/N 型号	OEM # 原装型号	Len. 长度
	 SCN23	Adult clip 成人指夹	SP9115A	1863/LNCS DCI	1m
		Adult soft 成人软指套	SP8115A		1m
		Pediatric clip 儿童指夹	SP7115A		1m
		Pediatric soft 儿童软指套	SP6115A		1m
		Neonate Wrap 新生儿包裹	SP5115A		1m
		Multi-Y 多功能Y型	SP4115A		1m
		Ear clip 成人耳夹	SP3115A		1m
			 SCN24	Adult clip 成人指夹	SP9115B
Adult soft 成人软指套	SP8115B				1m
Pediatric clip 儿童指夹	SP7115B			LNOP DC-IP	1m
Pediatric soft 儿童软指套	SP6115B				1m
Neonate Wrap 新生儿包裹	SP5115B				1m
Multi-Y 多功能Y型	SP4115B			1544	1m
Ear clip 成人耳夹	SP3115B			LNOP TC-I	1m
M-LNCS™ DCI	 SCN86			Adult clip 成人指夹	SP9115H
		Adult soft 成人软指套	SP8115H		1m
		Pediatric clip 儿童指夹	SP7115H		1m
		Pediatric soft 儿童软指套	SP6115H		1m
		Neonate Wrap 新生儿包裹	SP5115H		1m
		Multi-Y 多功能Y型	SP4115H		1m
		Ear clip 成人耳夹	SP3115H		1m

Masim Reusable Sensors 迈心诺重复性血氧探头

Models 监护仪型号	Connector 接头	Options 探头类型	Sino-K P/N 型号	OEM # 原装型号	Len. 长度
DB9PIN(M* chip)	 SCN23	Adult clip 成人指夹	SP9115F		1m
		Adult soft 成人软指套	SP8115F		1m
		Pediatric clip 儿童指夹	SP7115F		1m
		Pediatric soft 儿童软指套	SP6115F		1m
		Neonate Wrap 新生儿包裹	SP5115F		1m
		Multi-Y 多功能Y型	SP4115F		1m
		Ear clip 成人耳夹	SP3115F		1m
		Radical-7, Rad-87, Rad-57, Pronto	 SCN80	Adult clip 成人指夹	SP9315G
Adult soft 成人软指套	SP8315G				3m
Pediatric clip 儿童指夹	SP7315G				3m
Pediatric soft 儿童软指套	SP6315G				3m
Neonate Wrap 新生儿包裹	SP5315G				3m
Multi-Y 多功能Y型	SP4315G				3m
Ear clip 成人耳夹	SP3315G		3m		

M.D.E Reusable Sensors 重复性血氧探头

Models 监护仪型号	Connector 接头	Options 探头类型	Sino-K P/N 型号	OEM # 原装型号	Len. 长度
Escort II OPT30; Prism	 SCN30	Adult clip 成人指夹	SP9319		3m
		Adult soft 成人软指套	SP8319		3m
		Pediatric clip 儿童指夹	SP7319		3m
		Pediatric soft 儿童软指套	SP6319		3m
		Neonate Wrap 新生儿包裹	SP5319		3m
		Multi-Y 多功能Y型	SP4319		3m
		Ear clip 成人耳夹	SP3319		3m

Mediana Reusable Sensors 重复性血氧探头

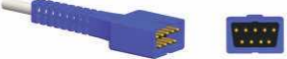
Models 监护仪型号	Connector 接头	Options 探头类型	Sino-K P/N 型号	OEM # 原装型号	Len. 长度
YM-2002 Series	 SCN31	Adult clip 成人指夹	SP9119A		1m
		Adult soft 成人软指套	SP8119A		1m
		Pediatric clip 儿童指夹	SP7119A		1m
		Pediatric soft 儿童软指套	SP6119A		1m
		Neonate Wrap 新生儿包裹	SP5119A		1m
		Multi-Y 多功能Y型	SP4119A		1m
		Ear clip 成人耳夹	SP3119A		1m



Medlab Reusable Sensors 重复性血氧探头

Models 监护仪型号	Connector 接头	Options 探头类型	Sino-K P/N 型号	OEM # 原装型号	Len. 长度
CAPNOX, VITRO, élan, POX 10, P-OX100L	 SCP7	Adult clip 成人指夹	SP9303		3m
		Adult soft 成人软指套	SP8303		3m
		Pediatric clip 儿童指夹	SP7303		3m
		Pediatric soft 儿童软指套	SP6303		3m
		Neonate Wrap 新生儿包裹	SP5303		3m
		Multi-Y 多功能Y型	SP4303		3m
		Ear clip 成人耳夹	SP3303		3m

MEK Reusable Sensors 重复性血氧探头

Models 监护仪型号	Connector 接头	Options 探头类型	Sino-K P/N 型号	OEM # 原装型号	Len. 长度
MP 100,110,400,1000	 SCN30	Adult clip 成人指夹	SP9316		3m
		Adult soft 成人软指套	SP8316		3m
		Pediatric clip 儿童指夹	SP7316		3m
		Pediatric soft 儿童软指套	SP6316		3m
		Neonate Wrap 新生儿包裹	SP5316		3m
		Multi-Y 多功能Y型	SP4316		3m
		Ear clip 成人耳夹	SP3316		3m



MEK Reusable Sensors 重复性血氧探头

Models 监护仪型号	Connector 接头	Options 探头类型	Sino-K P/N 型号	OEM # 原装型号	Len. 长度
MP 100,110,400,1000	 SCN30-L6	Adult clip 成人指夹	SP9116		1m
		Adult soft 成人软指套	SP8116		1m
		Pediatric clip 儿童指夹	SP7116		1m
		Pediatric soft 儿童软指套	SP6116		1m
		Neonate Wrap 新生儿包裹	SP5116		1m
		Multi-Y 多功能Y型	SP4116		1m
		Ear clip 成人耳夹	SP3116		1m
		Normal 8 pins	 SCN65	Adult clip 成人指夹	SP9316A
Adult soft 成人软指套	SP8316A				3m
Pediatric clip 儿童指夹	SP7316A				3m
Pediatric soft 儿童软指套	SP6316A				3m
Neonate Wrap 新生儿包裹	SP5316A				3m
Multi-Y 多功能Y型	SP4316A				3m
Normal 8 pins	 SCN65	Adult clip 成人指夹	SP9316B		3m
		Adult soft 成人软指套	SP8316B		3m
		Pediatric clip 儿童指夹	SP7316B		3m
		Pediatric soft 儿童软指套	SP6316B		3m
		Neonate Wrap 新生儿包裹	SP5316B		3m
		Multi-Y 多功能Y型	SP4316B		3m
		Ear clip 成人耳夹	SP3316B		3m

MEK Reusable Sensors 重复性血氧探头

Models 监护仪型号	Connector 接头	Options 探头类型	Sino-K P/N 型号	OEM # 原装型号	Len. 长度
	 SCN66	Adult clip 成人指夹	SP9316C		3m
		Adult soft 成人软指套	SP8316C		3m
		Pediatric clip 儿童指夹	SP7316C		3m
		Pediatric soft 儿童软指套	SP6316C		3m
		Neonate Wrap 新生儿包裹	SP5316C		3m
		Multi-Y 多功能Y型	SP4316C		3m
		Ear clip 成人耳夹	SP3316C		3m



Mennen Reusable Sensors 美能重复性血氧探头

Models 监护仪型号	Connector 接头	Options 探头类型	Sino-K P/N 型号	OEM # 原装型号	Len. 长度
Normal 8 pins	 SCN25	Adult clip 成人指夹	SP9317A		3m
		Adult soft 成人软指套	SP8317A		3m
		Pediatric clip 儿童指夹	SP7317A		3m
		Pediatric soft 儿童软指套	SP6317A		3m
		Neonate Wrap 新生儿包裹	SP5317A		3m
		Multi-Y 多功能Y型	SP4317A		3m
(Masim tech)	 SCN26	Ear clip 成人耳夹	SP3317A		3m
		成人指夹	SP9317B		3m
		Adult soft 成人软指套	SP8317B		3m
		Pediatric clip 儿童指夹	SP7317B		3m
		Pediatric soft 儿童软指套	SP6317B		3m
		Neonate Wrap 新生儿包裹	SP5317B		3m
		Multi-Y 多功能Y型	SP4317B		3m
		Ear clip 成人耳夹	SP3317B		3m

Mindray Reusable Sensors 迈瑞重复性血氧探头

Models 监护仪型号	Connector 接头	Options 探头类型	Sino-K P/N 型号	OEM # 原装型号	Len. 长度
12 Male pins	 SCN39	Adult clip 成人指夹	SP9318		3m
		Adult soft 成人软指套	SP8318		3m
		Pediatric clip 儿童指夹	SP7318		3m
		Pediatric soft 儿童软指套	SP6318		3m
		Neonate Wrap 新生儿包裹	SP5318		3m
		Multi-Y 多功能Y型	SP4318		3m
		Ear clip 成人耳夹	SP3318		3m
		12 Male pins (Masim tech)	 SCN39	Adult clip 成人指夹	SP9318A
Adult soft 成人软指套	SP8318A		3m		
Pediatric clip 儿童指夹	SP7318A		3m		
Pediatric soft 儿童软指套	SP6318A		3m		
Neonate Wrap 新生儿包裹	SP5318A		3m		
Multi-Y 多功能Y型	SP4318A		3m		
Ear clip 成人耳夹	SP3318A		3m		
503,507,508,509 (Criticare tech)	 SCM5	Adult clip 成人指夹	SP9318B		3m
		Adult soft 成人软指套	SP8318B		3m
		Pediatric clip 儿童指夹	SP7318B		3m
		Pediatric soft 儿童软指套	SP6318B		3m
		Neonate Wrap 新生儿包裹	SP5318B		3m
		Multi-Y 多功能Y型	SP4318B		3m
		Ear clip 成人耳夹	SP3318B		3m

Mindray Reusable Sensors 迈瑞重复性血氧探头



Models 监护仪型号	Connector 接头	Options 探头类型	Sino-K P/N 型号	OEM # 原装型号	Len. 长度
Normal 5 pins	 SCP5	Adult clip 成人指夹	SP9318C		3m
		Adult soft 成人软指套	SP8318C		3m
		Pediatric clip 儿童指夹	SP7318C		3m
		Pediatric soft 儿童软指套	SP6318C		3m
		Neonate Wrap 新生儿包裹	SP5318C		3m
		Multi-Y 多功能Y型	SP4318C		3m
		Ear clip 成人耳夹	SP3318C		3m
		Normal 6 pins	 SCP6	Adult clip 成人指夹	SP9318D
Adult soft 成人软指套	SP8318D				3m
Pediatric clip 儿童指夹	SP7318D				3m
Pediatric soft 儿童软指套	SP6318D				3m
Neonate Wrap 新生儿包裹	SP5318D				3m
Multi-Y 多功能Y型	SP4318D				3m
Ear clip 成人耳夹	SP3318D				3m
Pm7000, 8000, 9000, MEC-1000, MEC-2000 (6 pins, 40 degree) 科瑞康PC-900 PC-9000 M8B	 SCP6R	Adult clip 成人指夹	SP9318E		3m
		Adult soft 成人软指套	SP8318E		3m
		Pediatric clip 儿童指夹	SP7318E		3m
		Pediatric soft 儿童软指套	SP6318E		3m
		Neonate Wrap 新生儿包裹	SP5318E		3m
		Multi-Y 多功能Y型	SP4318E		3m
		Ear clip 成人耳夹	SP3318E		3m



Mindray Reusable Sensors 迈瑞重复性血氧探头

Models 监护仪型号	Connector 接头	Options 探头类型	Sino-K P/N 型号	OEM # 原装型号	Len. 长度
6 male pins, 40 degree (Masim tech)	 SCP6R	Adult clip 成人指夹	SP9318F		3m
		Adult soft 成人软指套	SP8318F		3m
		Pediatric clip 儿童指夹	SP7318F		3m
		Pediatric soft 儿童软指套	SP6318F		3m
		Neonate Wrap 新生儿包裹	SP5318F		3m
		Multi-Y 多功能Y型	SP4318F		3m
		Ear clip 成人耳夹	SP3318F		3m
		6 male pins, 60 degree (Masim tech)	 SCP6S	Adult clip 成人指夹	SP9318G
Adult soft 成人软指套	SP8318G				3m
Pediatric clip 儿童指夹	SP7318G				3m
Pediatric soft 儿童软指套	SP6318G				3m
Neonate Wrap 新生儿包裹	SP5318G				3m
Multi-Y 多功能Y型	SP4318G				3m
Ear clip 成人耳夹	SP3318G				3m
T5/T8 (Mindray tech)	 SCN27			Adult clip 成人指夹	SP9318H
		Adult soft 成人软指套	SP8318H		3m
		Pediatric clip 儿童指夹	SP7318H		3m
		Pediatric soft 儿童软指套	SP6318H		3m
		Neonate Wrap 新生儿包裹	SP5318H		3m
		Multi-Y 多功能Y型	SP4318H		3m
		Ear clip 成人耳夹	SP3318H		3m



Mindray Reusable Sensors 迈瑞重复性血氧探头

Models 监护仪型号	Connector 接头	Options 探头类型	Sino-K P/N 型号	OEM # 原装型号	Len. 长度
T5/T8(Masim tech)	 SCN28	Adult clip 成人指夹	SP9318J		3m
		Adult soft 成人软指套	SP8318J		3m
		Pediatric clip 儿童指夹	SP7318J		3m
		Pediatric soft 儿童软指套	SP6318J		3m
		Neonate Wrap 新生儿包裹	SP5318J		3m
		Multi-Y 多功能Y型	SP4318J		3m
		Ear clip 成人耳夹	SP3318J		3m
		T5/T8(Nellcor Oximax)	 SCN29	Adult clip 成人指夹	SP9318K
Adult soft 成人软指套	SP8318K				3m
Pediatric clip 儿童指夹	SP7318K				3m
Pediatric soft 儿童软指套	SP6318K				3m
Neonate Wrap 新生儿包裹	SP5318K				3m
Multi-Y 多功能Y型	SP4318K				3m
Ear clip 成人耳夹	SP3318K				3m

Mindray Reusable Sensors 迈瑞重复性血氧探头

Models 监护仪型号	Connector 接头	Options 探头类型	Sino-K P/N 型号	OEM # 原装型号	Len. 长度
	 SCP6T	Adult clip 成人指夹	SP9318L		3m
		Adult soft 成人软指套	SP8318L		3m
		Pediatric clip 儿童指夹	SP7318L		3m
		Pediatric soft 儿童软指套	SP6318L		3m
		Neonate Wrap 新生儿包裹	SP5318L		3m
		Multi-Y 多功能Y型	SP4318L		3m
		Ear clip 成人耳夹	SP3318L		3m

Mindray-Datascope Reusable Sensors 重复性血氧探头

Models 监护仪型号	Connector 接头	Options 探头类型	Sino-K P/N 型号	OEM # 原装型号	Len. 长度
Accusat, Accutor 3/4/SAT/PLUS Passport (Datascope Tech)	 SCN07	Adult clip 成人指夹	SP9308		3m
		Adult soft 成人软指套	SP8308		3m
		Pediatric clip 儿童指夹	SP7308		3m
		Pediatric soft 儿童软指套	SP6308		3m
		Neonate Wrap 新生儿包裹	SP5308		3m
		Multi-Y 多功能Y型	SP4308		3m
		Ear clip 成人耳夹	SP3308		3m
		Accusat, Accutor 3/4/SAT/PLUS Passport (Datascope Tech)	 SCN08	Adult clip 成人指夹	SP9108A
Adult soft 成人软指套	SP8108A				1m
Pediatric clip 儿童指夹	SP7108A				1m
Pediatric soft 儿童软指套	SP6108A				1m
Neonate Wrap 新生儿包裹	SP5108A				1m
Multi-Y 多功能Y型	SP4108A				1m
Ear clip 成人耳夹	SP3108A		1m		

Mindray-Datascope Reusable Sensors 重复性血氧探头

Models 监护仪型号	Connector 接头	Options 探头类型	Sino-K P/N 型号	OEM # 原装型号	Len. 长度
Passport II/ILT, XG, Accutor Plus, Expert(Nellcor) (Trio/Spectrum w/opt. Nellcor)	 SCN22	Adult clip 成人指夹	SP9319B		3m
		Adult soft 成人软指套	SP8319B		3m
		Pediatric clip 儿童指夹	SP7319B		3m
		Pediatric soft 儿童软指套	SP6319B		3m
		Neonate Wrap 新生儿包裹	SP5319B		3m
		Multi-Y 多功能Y型	SP4319B		3m
		Ear clip 成人耳夹	SP3319B		3m

Mindray-Datascope Reusable Sensors 重复性血氧探头

Models 监护仪型号	Connector 接头	Options 探头类型	Sino-K P/N 型号	OEM # 原装型号	Len. 长度
Passport II/ILT, XG, Accutor Plus, Trio, Spectrum (Masim)	 SCN22	Adult clip 成人指夹	SP9315		3m
		Adult soft 成人软指套	SP8315		3m
		Pediatric clip 儿童指夹	SP7315		3m
		Pediatric soft 儿童软指套	SP6315		3m
		Neonate Wrap 新生儿包裹	SP5315		3m
		Multi-Y 多功能Y型	SP4315		3m
		Ear clip 成人耳夹	SP3315		3m



M&B Reusable Sensors 北京麦邦重复性血氧探头

Models 监护仪型号	Connector 接头	Options 探头类型	Sino-K P/N 型号	OEM # 原装型号	Len. 长度
CD531, CD2000	 SCN70	Adult clip 成人指夹	SP9351		3m
		Adult soft 成人软指套	SP8351		3m
		Pediatric clip 儿童指夹	SP7351		3m
		Pediatric soft 儿童软指套	SP6351		3m
		Neonate Wrap 新生儿包裹	SP5351		3m
		Multi-Y 多功能Y型	SP4351		3m
		Ear clip 成人耳夹	SP3351		3m

Nellcor Reusable Sensors 重复性血氧探头

Models 监护仪型号	Connector 接头	Options 探头类型	Sino-K P/N 型号	OEM # 原装型号	Len. 长度
NPB 40, NPB20, NPB75, NPB 180, NPB 185, NPB-190, NPB-195, NPB 3900, NPB 4000	 SCN30	Adult clip 成人指夹	SP9319		3m
		Adult soft 成人软指套	SP8319		3m
		Pediatric clip 儿童指夹	SP7319		3m
		Pediatric soft 儿童软指套	SP6319		3m
		Neonate Wrap 新生儿包裹	SP5319		3m
		Multi-Y 多功能Y型	SP4319		3m
		Ear clip 成人耳夹	SP3319		3m

Nellcor Reusable Sensors 重复性血氧探头

Models 监护仪型号	Connector 接头	Options 探头类型	Sino-K P/N 型号	OEM # 原装型号	Len. 长度
NPB 40, NPB20, NPB75, NPB 180, NPB 185, NPB-190, NPB-195, NPB 3900, NPB 4000	 SCN30	Adult clip 成人指夹	SP9119		1m
		Adult soft 成人软指套	SP8119		1m
		Pediatric clip 儿童指夹	SP7119		1m
		Pediatric soft 儿童软指套	SP6119		1m
		Neonate Wrap 新生儿包裹	SP5119		1m
		Multi-Y 多功能Y型	SP4119		1m
		Ear clip 成人耳夹	SP3119		1m
		N550, N560, N595, N600, N751, N550DASH 2500, SOLAR 8000, 8000M, N65 Except CARESCAPE V100	 SCN31	Adult clip 成人指夹	SP9319A
Adult soft 成人软指套	SP8319A			3m	
Pediatric clip 儿童指夹	SP7319A			3m	
Pediatric soft 儿童软指套	SP6319A			3m	
Neonate Wrap 新生儿包裹	SP5319A			3m	
Multi-Y 多功能Y型	SP4319A			3m	
Ear clip 成人耳夹	SP3319A			3m	
N550, N560, N595, N600, N751, N550DASH 2500, SOLAR 8000, 8000M, N65 Except CARESCAPE V100	 SCN31	Adult clip 成人指夹		SP9119A	DS-100A
		Adult soft 成人软指套	SP8119A		1m
		Pediatric clip 儿童指夹	SP7119A		1m
		Pediatric soft 儿童软指套	SP6119A		1m
		Neonate Wrap 新生儿包裹	SP5119A		1m
		Multi-Y 多功能Y型	SP4119A	D-YS	1m
		Ear clip 成人耳夹	SP3119A		1m

Nellcor Reusable Sensors 重复性血氧探头

Models 监护仪型号	Connector 接头	Options 探头类型	Sino-K P/N 型号	OEM # 原装型号	Len. 长度
NPB3000-3100, Symphony, NPB290, 295, 395	 SCN22	Adult clip 成人指夹	SP9319B		3m
		Adult soft 成人软指套	SP8319B		3m
		Pediatric clip 儿童指夹	SP7319B		3m
		Pediatric soft 儿童软指套	SP6319B		3m
		Neonate Wrap 新生儿包裹	SP5319B		3m
		Multi-Y 多功能Y型	SP4319B		3m
		Ear clip 成人耳夹	SP3319B		3m
		N560, N600X	 SCN46	Adult clip 成人指夹	SP9319C
Adult soft 成人软指套	SP8319C				3m
Pediatric clip 儿童指夹	SP7319C				3m
Pediatric soft 儿童软指套	SP6319C				3m
Neonate Wrap 新生儿包裹	SP5319C				3m
Multi-Y 多功能Y型	SP4319C				3m
Ear clip 成人耳夹	SP3319C				3m

Nihon Kohden Reusable Sensors 光电重复性血氧探头

Models 监护仪型号	Connector 接头	Options 探头类型	Sino-K P/N 型号	OEM # 原装型号	Len. 长度
AL-800PA Module; BSM-1101, 2101/2, 3101, 7100, 7200; OLV-1100A, Lifescope	 SCN32	Adult clip 成人指夹	SP9321	TL-101S	3m
		Adult soft 成人软指套	SP8321		3m
		Pediatric clip 儿童指夹	SP7321		3m
		Pediatric soft 儿童软指套	SP6321		3m
		Neonate Wrap 新生儿包裹	SP5321		3m
		Multi-Y 多功能Y型	SP4321		3m
		Ear clip 成人耳夹	SP3321		3m



Nihon Kohden Reusable Sensors 光电重复性血氧探头

Models 监护仪型号	Connector 接头	Options 探头类型	Sino-K P/N 型号	OEM # 原装型号	Len. 长度
BSM-2301K, BSM-2303K, BSM-2351, BSM-2353, BSM-4103, BSM-4113	 SCN33	Adult clip 成人指夹	SP9121A	TL-201T	1m
		Adult soft 成人软指套	SP8121A		1m
		Pediatric clip 儿童指夹	SP7121A		1m
		Pediatric soft 儿童软指套	SP6121A		1m
		Neonate Wrap 新生儿包裹	SP5121A	TL-220T	1m
		Multi-Y 多功能Y型	SP4121A		1m
		Ear clip 成人耳夹	SP3121A		1m
		Adult clip 成人指夹	SP9321B		3m
Adult soft 成人软指套	SP8321B		3m		
Pediatric clip 儿童指夹	SP7321B		3m		
Pediatric soft 儿童软指套	SP6321B		3m		
Neonate Wrap 新生儿包裹	SP5321B		3m		
Multi-Y 多功能Y型	SP4321B		3m		
Ear clip 成人耳夹	SP3321B		3m		
Lifescope OPV 1500 1500k	 SCN84	Adult clip 成人指夹	SP9321C		3m
		Adult soft 成人软指套	SP8321C		3m
		Pediatric clip 儿童指夹	SP7321C		3m
		Pediatric soft 儿童软指套	SP6321C		3m
		Neonate Wrap 新生儿包裹	SP5321C		3m
		Multi-Y 多功能Y型	SP4321C		3m
		Ear clip 成人耳夹	SP3321C		3m



Nihon Kohden Reusable Sensors 光电重复性血氧探头

Models 监护仪型号	Connector 接头	Options 探头类型	Sino-K P/N 型号	OEM # 原装型号	Len. 长度
BSM Series ,Oximax	 SCN85	Adult clip 成人指夹	SP9321D		3m
		Adult soft 成人软指套	SP8321D		3m
		Pediatric clip 儿童指夹	SP7321D		3m
		Pediatric soft 儿童软指套	SP6321D		3m
		Neonate Wrap 新生儿包裹	SP5321D		3m
		Multi-Y 多功能Y型	SP4321D		3m
		Ear clip 成人耳夹	SP3321D		3m

Nonin Reusable Sensors 燕牌重复性血氧探头

Models 监护仪型号	Connector 接头	Options 探头类型	Sino-K P/N 型号	OEM # 原装型号	Len. 长度
8604	 SCM6	Adult clip 成人指夹	SP9322		3m
		Adult soft 成人软指套	SP8322		3m
		Pediatric clip 儿童指夹	SP7322		3m
		Pediatric soft 儿童软指套	SP6322		3m
		Neonate Wrap 新生儿包裹	SP5322		3m
		Multi-Y 多功能Y型	SP4322		3m
		Ear clip 成人耳夹	SP3322		3m
8500, PamSAT 2500, Avant 9600, Avant 9700, Avant 2120, 9840	 SCN83	Adult clip 成人指夹	SP9122B	8000AA-1+8500VI	1m
		Adult soft 成人软指套	SP8122B	8000AA-1+8500VI	1m
		Pediatric clip 儿童指夹	SP7122B		1m
		Pediatric soft 儿童软指套	SP6122B		1m
		Neonate Wrap 新生儿包裹	SP5122B		1m
		Multi-Y 多功能Y型	SP4122B		1m
		Ear clip 成人耳夹	SP3122B		1m

Neusoft Reusable Sensors 东软重复性血氧探头

Models 监护仪型号	Connector 接头	Options 探头类型	Sino-K P/N 型号	OEM # 原装型号	Len. 长度
	 SCP7	Adult clip 成人指夹	SP9343		3m
		Adult soft 成人软指套	SP8343		3m
		Pediatric clip 儿童指夹	SP7343		3m
		Pediatric soft 儿童软指套	SP6343		3m
		Neonate Wrap 新生儿包裹	SP5343		3m
		Multi-Y 多功能Y型	SP4343		3m
		Ear clip 成人耳夹	SP3343		3m
		General 杰纳瑞 (Digital)	 SCN39	Adult clip 成人指夹	SP9343A
Adult soft 成人软指套	SP8343A			3m	
Pediatric clip 儿童指夹	SP7343A			3m	
Pediatric soft 儿童软指套	SP6343A			3m	
Neonate Wrap 新生儿包裹	SP5343A			3m	
Multi-Y 多功能Y型	SP4343A			3m	
Ear clip 成人耳夹	SP3343A			3m	

Novamatrix Reusable Sensors 诺医重复性血氧探头

Models 监护仪型号	Connector 接头	Options 探头类型	Sino-K P/N 型号	OEM # 原装型号	Len. 长度
505, 510, 511, 515B, 515C, 520, 7000, 7100, Oxypleth	 SCN36	Adult clip 成人指夹	SP9323	8776-00	3m
		Adult soft 成人软指套	SP8323		3m
		Pediatric clip 儿童指夹	SP7323		3m
		Pediatric soft 儿童软指套	SP6323		3m
		Neonate Wrap 新生儿包裹	SP5323		3m
		Multi-Y 多功能Y型	SP4323		3m
		Ear clip 成人耳夹	SP3323		3m

Novamatrix Reusable Sensors 诺医重复性血氧探头

Models 监护仪型号	Connector 接头	Options 探头类型	Sino-K P/N 型号	OEM # 原装型号	Len. 长度
512/513/710/715,MARS	 SCN37	Adult clip 成人指夹	SP9123A		1m
		Adult soft 成人软指套	SP8123A		1m
		Pediatric clip 儿童指夹	SP7123A		1m
		Pediatric soft 儿童软指套	SP6123A		1m
		Neonate Wrap 新生儿包裹	SP5123A		1m
		Multi-Y 多功能Y型	SP4123A		1m
		Ear clip 成人耳夹	SP3123A		1m
			 SCN04	Adult clip 成人指夹	SP9123B
Adult soft 成人软指套	SP8123B				1m
Pediatric clip 儿童指夹	SP7123B				1m
Pediatric soft 儿童软指套	SP6123B				1m
Neonate Wrap 新生儿包裹	SP5123B				1m
Multi-Y 多功能Y型	SP4123B				1m
Ear clip 成人耳夹	SP3123B				1m

Palco Reusable Sensors 派克重复性血氧探头

Models 监护仪型号	Connector 接头	Options 探头类型	Sino-K P/N 型号	OEM # 原装型号	Len. 长度
All	 SCN38	Adult clip 成人指夹	SP9324		3m
		Adult soft 成人软指套	SP8324		3m
		Pediatric clip 儿童指夹	SP7324		3m
		Pediatric soft 儿童软指套	SP6324		3m
		Neonate Wrap 新生儿包裹	SP5324		3m
		Multi-Y 多功能Y型	SP4324		3m
		Ear clip 成人耳夹	SP3324		3m

Palco Reusable Sensors 派克重复性血氧探头

Models 监护仪型号	Connector 接头	Options 探头类型	Sino-K P/N 型号	OEM # 原装型号	Len. 长度
 SCN67	Adult clip 成人指夹	SP9324A		3m	
	Adult soft 成人软指套	SP8324A		3m	
	Pediatric clip 儿童指夹	SP7324A		3m	
	Pediatric soft 儿童软指套	SP6324A		3m	
	Neonate Wrap 新生儿包裹	SP5324A		3m	
	Multi-Y 多功能Y型	SP4324A		3m	
	Ear clip 成人耳夹	SP3324A		3m	

Pace Tech/Generra Reusable Sensors 重复性血氧探头

Models 监护仪型号	Connector 接头	Options 探头类型	Sino-K P/N 型号	OEM # 原装型号	Len. 长度
 SCN19	Adult clip 成人指夹	SP9311C		3m	
	Adult soft 成人软指套	SP8311C		3m	
	Pediatric clip 儿童指夹	SP7311C		3m	
	Pediatric soft 儿童软指套	SP6311C		3m	
	Neonate Wrap 新生儿包裹	SP5311C		3m	
	Multi-Y 多功能Y型	SP4311C		3m	
	Ear clip 成人耳夹	SP3311C		3m	



Perlong Reusable Sensors 南京普朗重复性血氧探头

Models 监护仪型号	Connector 接头	Options 探头类型	Sino-K P/N 型号	OEM # 原装型号	Len. 长度
 SCP6	Adult clip 成人指夹	SP9364		3m	
	Adult soft 成人软指套	SP8364		3m	
	Pediatric clip 儿童指夹	SP7364		3m	
	Pediatric soft 儿童软指套	SP6364		3m	
	Neonate Wrap 新生儿包裹	SP5364		3m	
	Multi-Y 多功能Y型	SP4364		3m	
	Ear clip 成人耳夹	SP3364		3m	

Philips-HP- Agilent Reusable Sensors 飞利浦重复性血氧探头

Models 监护仪型号	Connector 接头	Options 探头类型	Sino-K P/N 型号	OEM # 原装型号	Len. 长度
78352C, 78354C, 78834C, M1020A, M1025B, M1025A, M1350B, M1722A/B, M1732A/B, M2475B, ViridaA1, A3	 SCN39	Adult clip 成人指夹	SP9325	M1900B+M1196T	3m
		Adult soft 成人软指套	SP8325	M1900B+M1191T	3m
		Pediatric clip 儿童指夹	SP7325		3m
		Pediatric soft 儿童软指套	SP6325	M1900B+M1192T	3m
		Neonate Wrap 新生儿包裹	SP5325	M1900B+M1193T	3m
		Multi-Y 多功能Y型	SP4325		3m
		Ear clip 成人耳夹	SP3325		3m

Philips-HP- Agilent Reusable Sensors 飞利浦重复性血氧探头

Models 监护仪型号	Connector 接头	Options 探头类型	Sino-K P/N 型号	OEM # 原装型号	Len. 长度
MP20, MP30, MP40/50/60/70/90. VM4, VM6, VM8, M3046A	 SCN40	Adult clip 成人指夹	SP9325A	M1196A	3m
		Adult soft 成人软指套	SP8325A	M1191A/B M1191AL/BL	3m
		Pediatric clip 儿童指夹	SP7325A	M1196A	3m
		Pediatric soft 儿童软指套	SP6325A	M1192A	3m
		Neonate Wrap 新生儿包裹	SP5325A	M1193A	3m
		Multi-Y 多功能Y型	SP4325A		3m
		Ear clip 成人耳夹	SP3325A	M1194A	3m
MP20, MP30, MP40/50/60/70/90. VM4, VM6, VM8, M3046A	 SCN40	Adult clip 成人指夹	SP9125A		1m
		Adult soft 成人软指套	SP8125A		1m
		Pediatric clip 儿童指夹	SP7125A		1m
		Pediatric soft 儿童软指套	SP6125A		1m
		Neonate Wrap 新生儿包裹	SP5125A		1m
		Multi-Y 多功能Y型	SP4125A		1m
		Ear clip 成人耳夹	SP3125A		1m

Philips-HP- Agilent Reusable Sensors 飞利浦重复性血氧探头

Models 监护仪型号	Connector 接头	Options 探头类型	Sino-K P/N 型号	OEM # 原装型号	Len. 长度
Philips-masim	 SCN41	Adult clip 成人指夹	SP9325B		3m
		Adult soft 成人软指套	SP8325B		3m
		Pediatric clip 儿童指夹	SP7325B		3m
		Pediatric soft 儿童软指套	SP6325B		3m
		Neonate Wrap 新生儿包裹	SP5325B		3m
		Multi-Y 多功能Y型	SP4325B		3m
		Ear clip 成人耳夹	SP3325B		3m

RGB Reusable Sensors 重复性血氧探头

Models 监护仪型号	Connector 接头	Options 探头类型	Sino-K P/N 型号	OEM # 原装型号	Len. 长度
Omicrom FT, Omicron PREMIUM	 SCP7	Adult clip 成人指夹	SP9303		3m
		Adult soft 成人软指套	SP8303		3m
		Pediatric clip 儿童指夹	SP7303		3m
		Pediatric soft 儿童软指套	SP6303		3m
		Neonate Wrap 新生儿包裹	SP5303		3m
		Multi-Y 多功能Y型	SP4303		3m
		Ear clip 成人耳夹	SP3303		3m

Physio-Control Reusable Sensors 重复性血氧探头

Models 监护仪型号	Connector 接头	Options 探头类型	Sino-K P/N 型号	OEM # 原装型号	Len. 长度
Lifepak 12	 SCN30	Adult clip 成人指夹	SP9319		3m
		Adult soft 成人软指套	SP8319		3m
		Pediatric clip 儿童指夹	SP7319		3m
		Pediatric soft 儿童软指套	SP6319		3m
		Neonate Wrap 新生儿包裹	SP5319		3m
		Multi-Y 多功能Y型	SP4319		3m
		Ear clip 成人耳夹	SP3319		3m
Lifepak 12, 20(Masim tech)	 SCN22	Adult clip 成人指夹	SP9315		3m
		Adult soft 成人软指套	SP8315		3m
		Pediatric clip 儿童指夹	SP7315		3m
		Pediatric soft 儿童软指套	SP6315		3m
		Neonate Wrap 新生儿包裹	SP5315		3m
		Multi-Y 多功能Y型	SP4315		3m
		Ear clip 成人耳夹	SP3315		3m

Schiller/ODM/ Brucker Reusable Sensors 席勒重复性血氧探头

Models 监护仪型号	Connector 接头	Options 探头类型	Sino-K P/N 型号	OEM # 原装型号	Len. 长度
CM8	 SCN42	Adult clip 成人指夹	SP9326		3m
		Adult soft 成人软指套	SP8326		3m
		Pediatric clip 儿童指夹	SP7326		3m
		Pediatric soft 儿童软指套	SP6326		3m
		Neonate Wrap 新生儿包裹	SP5326		3m
		Multi-Y 多功能Y型	SP4326		3m
		Ear clip 成人耳夹	SP3326		3m
TM7, Argus LCM	 SCN42	Adult clip 成人指夹	SP9326A		3m
		Adult soft 成人软指套	SP8326A		3m
		Pediatric clip 儿童指夹	SP7326A		3m
		Pediatric soft 儿童软指套	SP6326A		3m
		Neonate Wrap 新生儿包裹	SP5326A		3m
		Multi-Y 多功能Y型	SP4326A		3m
		Ear clip 成人耳夹	SP3326A		3m

Schiller/ODM/ Brucker Reusable Sensors 席勒重复性血氧探头

Models 监护仪型号	Connector 接头	Options 探头类型	Sino-K P/N 型号	OEM # 原装型号	Len. 长度
TM 910	 SCN43	Adult clip 成人指夹	SP9326B		3m
		Adult soft 成人软指套	SP8326B		3m
		Pediatric clip 儿童指夹	SP7326B		3m
		Pediatric soft 儿童软指套	SP6326B		3m
		Neonate Wrap 新生儿包裹	SP5326B		3m
		Multi-Y 多功能Y型	SP4326B		3m
		Ear clip 成人耳夹	SP3326B		3m

Schiller/ODM/ Brucker Reusable Sensors 席勒重复性血氧探头

Models 监护仪型号	Connector 接头	Options 探头类型	Sino-K P/N 型号	OEM # 原装型号	Len. 长度
Schiller Truscope	 SCP7	Adult clip 成人指夹	SP9326C		3m
		Adult soft 成人软指套	SP8326C		3m
		Pediatric clip 儿童指夹	SP7326C		3m
		Pediatric soft 儿童软指套	SP6326C		3m
		Neonate Wrap 新生儿包裹	SP5326C		3m
		Multi-Y 多功能Y型	SP4326C		3m
		Ear clip 成人耳夹	SP3326C		3m

Spacelabs Reusable Sensors 太空重复性血氧探头

Models 兼容型号	Connector 接头	Options 探头	Sino-k P/N 型号	OEM # 原装	Len. 长度
90419, 90501, 90651A-03	 SCN36	Adult clip 成人指夹	SP9323	369083-001	3m
		Adult soft 成人软指套	SP8323		3m
		Pediatric clip 儿童指夹	SP7323		3m
		Pediatric soft 儿童软指套	SP6323		3m
		Neonate Wrap 新生儿包裹	SP5323		3m
		Multi-Y 多功能Y型	SP4323		3m
		Ear clip 成人耳夹	SP3323		3m

Spacelabs Reusable Sensors 太空重复性血氧探头



Models 兼容型号	Connector 接头	Options 探头	Sino-k P/N 型号	OEM # 原装	Len. 长度
90351-0/6, 90465, 90466, 90467, 90651A-08, PC Express, 90489, IM77	 SCN44	Adult clip 成人指夹	SP9327	015-0130-00 +175-0646-00	3m
		Adult soft 成人软指套	SP8327	015-0130-00 +175-0646-00	3m
		Pediatric clip 儿童指夹	SP7327		3m
		Pediatric soft 儿童软指套	SP6327		3m
		Neonate Wrap 新生儿包裹	SP5327		3m
		Multi-Y 多功能Y型	SP4327		3m
		Ear clip 成人耳夹	SP3327		3m
		90496 Ultraview	 SCN45	Adult clip 成人指夹	SP9327A
Adult soft 成人软指套	SP8327A			015-0130-00 +700-0029-00	3m
Pediatric clip 儿童指夹	SP7327A				3m
Pediatric soft 儿童软指套	SP6327A				3m
Neonate Wrap 新生儿包裹	SP5327A				3m
Multi-Y 多功能Y型	SP4327A				3m
Ear clip 成人耳夹	SP3327A				3m
(Masim tech)	 SCN48	Adult clip 成人指夹	SP9327B		3m
		Adult soft 成人软指套	SP8327B		3m
		Pediatric clip 儿童指夹	SP7327B		3m
		Pediatric soft 儿童软指套	SP6327B		3m
		Neonate Wrap 新生儿包裹	SP5327B		3m
		Multi-Y 多功能Y型	SP4327B		3m
		Ear clip 成人耳夹	SP3327B		3m



Spacelabs-Burdick Reusable Sensors 太空重复性血氧探头

Models 监护仪型号	Connector 接头	Options 探头类型	Sino-K P/N 型号	OEM # 原装型号	Len. 长度
PRO2	 SCN04	Adult clip 成人指夹	SP9303A		3m
		Adult soft 成人软指套	SP8303A		3m
		Pediatric clip 儿童指夹	SP7303A		3m
		Pediatric soft 儿童软指套	SP6303A		3m
		Neonate Wrap 新生儿包裹	SP5303A		3m
		Multi-Y 多功能Y型	SP4303A		3m
		Ear clip 成人耳夹	SP3303A		3m

Solaris/New Tech Reusable Sensors 索莱瑞/纽泰克重复性血氧探头

Models 监护仪型号	Connector 接头	Options 探头类型	Sino-K P/N 型号	OEM # 原装型号	Len. 长度
(Digital)	 SCP5	Adult clip 成人指夹	SP9320		3m
		Adult soft 成人软指套	SP8320		3m
		Pediatric clip 儿童指夹	SP7320		3m
		Pediatric soft 儿童软指套	SP6320		3m
		Neonate Wrap 新生儿包裹	SP5320		3m
		Multi-Y 多功能Y型	SP4320		3m
		Ear clip 成人耳夹	SP3320		3m
General 杰纳瑞 (Digital)	 SCP6R	Adult clip 成人指夹	SP9320A		3m
		Adult soft 成人软指套	SP8320A		3m
		Pediatric clip 儿童指夹	SP7320A		3m
		Pediatric soft 儿童软指套	SP6320A		3m
		Neonate Wrap 新生儿包裹	SP5320A		3m
		Multi-Y 多功能Y型	SP4320A		3m
		Ear clip 成人耳夹	SP3320A		3m

Solaris/New Tech Reusable Sensors 索莱瑞/纽泰克重复性血氧探头

Models 监护仪型号	Connector 接头	Options 探头类型	Sino-K P/N 型号	OEM # 原装型号	Len. 长度
(Digital)	 SCN30	Adult clip 成人指夹	SP9120B		1m
		Adult soft 成人软指套	SP8120B		1m
		Pediatric clip 儿童指夹	SP7120B		1m
		Pediatric soft 儿童软指套	SP6120B		1m
		Neonate Wrap 新生儿包裹	SP5120B		1m
		Multi-Y 多功能Y型	SP4120B		1m
		Ear clip 成人耳夹	SP3120B		1m
		世博达(Digital)	 SCP7	Adult clip 成人指夹	SP9320C
Adult soft 成人软指套	SP8320C				3m
Pediatric clip 儿童指夹	SP7320C				3m
Pediatric soft 儿童软指套	SP6320C				3m
Neonate Wrap 新生儿包裹	SP5320C				3m
Multi-Y 多功能Y型	SP4320C				3m
Ear clip 成人耳夹	SP3320C				3m
科瑞康PC-5000(Digital)	 SCP5T	Adult clip 成人指夹	SP9320D		3m
		Adult soft 成人软指套	SP8320D		3m
		Pediatric clip 儿童指夹	SP7320D		3m
		Pediatric soft 儿童软指套	SP6320D		3m
		Neonate Wrap 新生儿包裹	SP5320D		3m
		Multi-Y 多功能Y型	SP4320D		3m
Ear clip 成人耳夹	SP3320D		3m		

Solaris/New Tech Reusable Sensors 索莱瑞/纽泰克重复性血氧探头

Models 监护仪型号	Connector 接头	Options 探头类型	Sino-K P/N 型号	OEM # 原装型号	Len. 长度
(Digital)	 SCN40	Adult clip 成人指夹	SP9320E		3m
		Adult soft 成人软指套	SP8320E		3m
		Pediatric clip 儿童指夹	SP7320E		3m
		Pediatric soft 儿童软指套	SP6320E		3m
		Neonate Wrap 新生儿包裹	SP5320E		3m
		Multi-Y 多功能Y型	SP4320E		3m
		Ear clip 成人耳夹	SP3320E		3m
		Adult clip 成人指夹	SP9320F		3m
Adult soft 成人软指套	SP8320F		3m		
Pediatric clip 儿童指夹	SP7320F		3m		
Pediatric soft 儿童软指套	SP6320F		3m		
Neonate Wrap 新生儿包裹	SP5320F		3m		
Multi-Y 多功能Y型	SP4320F		3m		
Ear clip 成人耳夹	SP3320F		3m		

Sunmind Reusable Sensors 深迈重复性血氧探头

Models 监护仪型号	Connector 接头	Options 探头类型	Sino-K P/N 型号	OEM # 原装型号	Len. 长度
	 SCN40	Adult clip 成人指夹	SP9348		3m
		Adult soft 成人软指套	SP8348		3m
		Pediatric clip 儿童指夹	SP7348		3m
		Pediatric soft 儿童软指套	SP6348		3m
		Neonate Wrap 新生儿包裹	SP5348		3m
		Multi-Y 多功能Y型	SP4348		3m
		Ear clip 成人耳夹	SP3348		3m

Sunmind Reusable Sensors 深迈重复性血氧探头

Models 监护仪型号	Connector 接头	Options 探头类型	Sino-K P/N 型号	OEM # 原装型号	Len. 长度
(Digital)	 SCN40	Adult clip 成人指夹	SP9348A		3m
		Adult soft 成人软指套	SP8348A		3m
		Pediatric clip 儿童指夹	SP7348A		3m
		Pediatric soft 儿童软指套	SP6348A		3m
		Neonate Wrap 新生儿包裹	SP5348A		3m
		Multi-Y 多功能Y型	SP4348A		3m
		Ear clip 成人耳夹	SP3348A		3m

3F Reusable Sensors 上海三埃弗重复性血氧探头

Models 监护仪型号	Connector 接头	Options 探头类型	Sino-K P/N 型号	OEM # 原装型号	Len. 长度
CD531, CD2000	 SCN70	Adult clip 成人指夹	SP9351		3m
		Adult soft 成人软指套	SP8351		3m
		Pediatric clip 儿童指夹	SP7351		3m
		Pediatric soft 儿童软指套	SP6351		3m
		Neonate Wrap 新生儿包裹	SP5351		3m
		Multi-Y 多功能Y型	SP4351		3m
		Ear clip 成人耳夹	SP3351		3m

Welch Allyn Protocol Reusable Sensors 伟伦重复性血氧探头

Models 监护仪型号	Connector 接头	Options 探头类型	Sino-K P/N 型号	OEM # 原装型号	Len. 长度
Propaq 206-EL, 204-EL, 202-EL, 106-EL	 SCN30	Adult clip 成人指夹	SP9319		3m
		Adult soft 成人软指套	SP8319		3m
		Pediatric clip 儿童指夹	SP7319		3m
		Pediatric soft 儿童软指套	SP6319		3m
		Neonate Wrap 新生儿包裹	SP5319		3m
		Multi-Y 多功能Y型	SP4319		3m
		Ear clip 成人耳夹	SP3319		3m

# REUSABLE SPO<sub>2</sub> SENSORS 重复性血氧探头

## Weinmann Reusable Sensors 重复性血氧探头

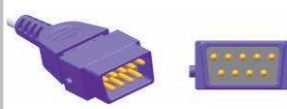
Models 监护仪型号	Connector 接头	Options 探头类型	Sino-K P/N 型号	OEM # 原装型号	Len. 长度
Oxycount Mini	 SCN81	Adult clip 成人指夹	SP9303A		3m
		Adult soft 成人软指套	SP8303A		3m
		Pediatric clip 儿童指夹	SP7303A		3m
		Pediatric soft 儿童软指套	SP6303A		3m
		Neonate Wrap 新生儿包裹	SP5303A		3m
		Multi-Y 多功能Y型	SP4303A		3m
		Ear clip 成人耳夹	SP3303A		3m

## Zondan Reusable Sensors 和心重典重复性血氧探头

Models 监护仪型号	Connector 接头	Options 探头类型	Sino-K P/N 型号	OEM # 原装型号	Len. 长度
ZD120	 SCP6	Adult clip 成人指夹	SP9345		3m
		Adult soft 成人软指套	SP8345		3m
		Pediatric clip 儿童指夹	SP7345		3m
		Pediatric soft 儿童软指套	SP6345		3m
		Neonate Wrap 新生儿包裹	SP5345		3m
		Multi-Y 多功能Y型	SP4345		3m
		Ear clip 成人耳夹	SP3345		3m

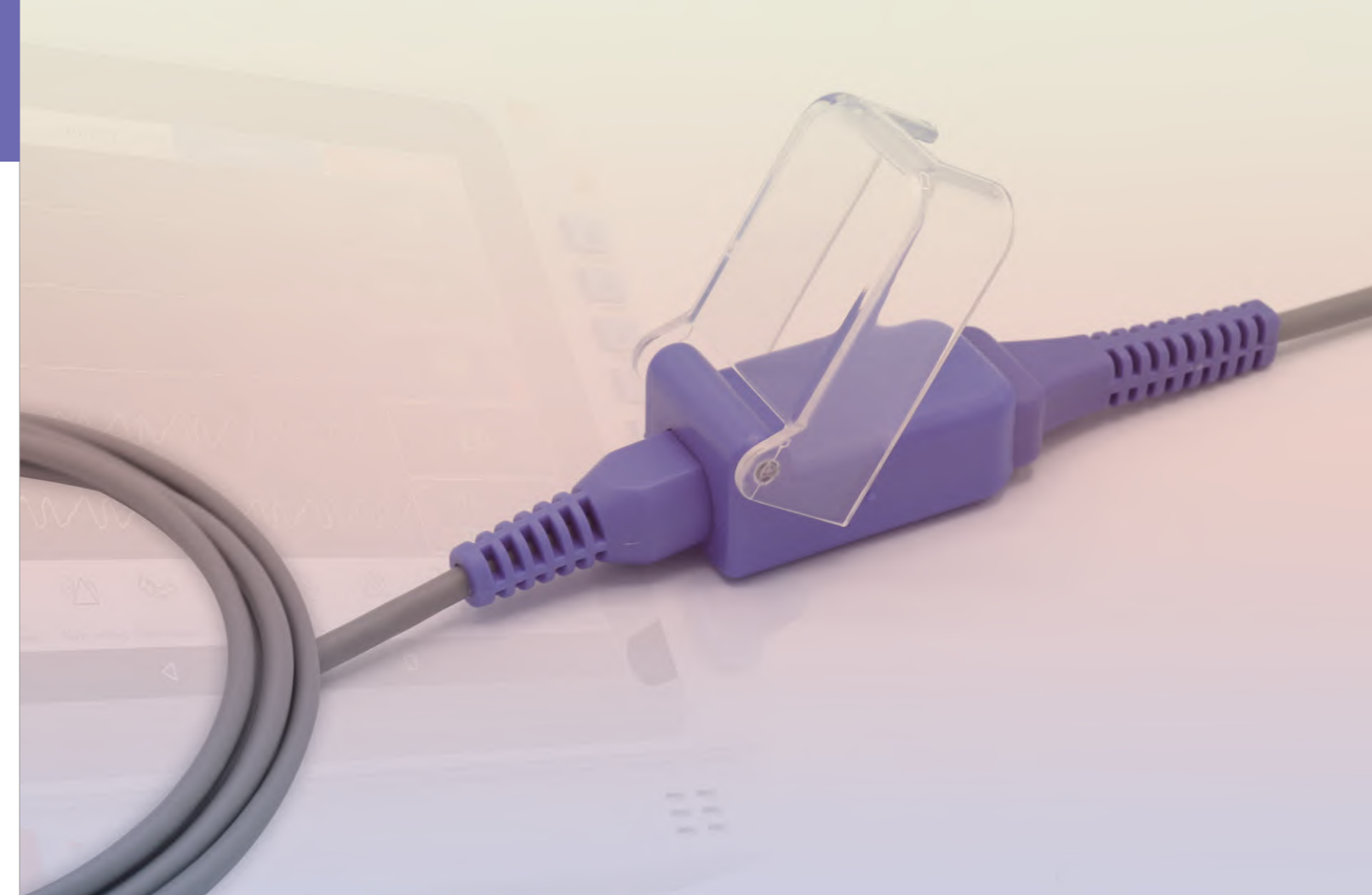

## Adapter cables 血氧转接线





Compliance with  
符合标准

ISO 13485: 2016



ISO10993-5-2009

ISO10993-10-2009





Artema-S&W Adapter Cables 阿体玛血氧转接线

Monitor side conn. P/N 监护仪端接头	Sensor side conn. P/N 探头端接头	Use with sensor 适用于	Sino-K P/N 型号	OEM # 原装型号	Len. 长度
 SCN01	 SCN49	Nellcor non-oximax	SP0201		2.2m
 SCN02	 SCN49	Ohmeda	SP0201A		2.2m

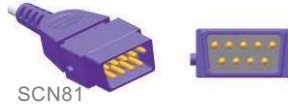

Baxter Adapter Cables 百特血氧转接线

Monitor side conn. P/N 监护仪端接头	Sensor side conn. P/N 探头端接头	Use with sensor 适用于	Sino-K P/N 型号	OEM # 原装型号	Len. 长度
 SCN03	 SCN49	Nellcor non-oximax /BCI	SP0202		2.2m







BCI/Smiths Adapter Cables 血氧转接线

Monitor side conn. P/N 监护仪端接头	Sensor side conn. P/N 探头端接头	Use with sensor 适用于	Sino-K P/N 型号	OEM # 原装型号	Len. 长度
 SCP7	 SCN50	BCI	SP0203		2.2m
 SCN81	 SCN50	BCI	SP0203A	3311	2.2m





Bionet Adapter Cables 血氧转接线

Monitor side conn. P/N 监护仪端接头	Sensor side conn. P/N 探头端接头	Use with sensor 适用于	Sino-K P/N 型号	OEM # 原装型号	Len. 长度
 SCP7	 SCN49	Nellcor non-oximax	SP0206		2.2m







Biolight Adapter Cables 宝莱特血氧转接线

Monitor side conn. P/N 监护仪端接头	Sensor side conn. P/N 探头端接头	Use with sensor 适用于	Sino-K P/N 型号	OEM # 原装型号	Len. 长度
 SCP5	 SCN49	Nellcor non-oximax/BCI	SP0205		2.2m
 SCP7	 SCN49	Nellcor Oximax	SP0205B		2.2m
 SCN62	 SCN49	Digital	SP0205E		2.2m

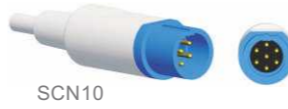

CSI Adapter Cables 血氧转接线

Monitor side conn. P/N 监护仪端接头	Sensor side conn. P/N 探头端接头	Use with sensor 适用于	Sino-K P/N 型号	OEM # 原装型号	Len. 长度
 SCM5	 SCN50	CSI	SP0207	518LD	2.2m
 SCN06	 SCN50	CSI	SP0207A	518DD	2.2m





Dräger Adapter Cables 德尔格血氧转接线

Monitor side conn. P/N 监护仪端接头	Sensor side conn. P/N 探头端接头	Use with sensor 适用于	Sino-K P/N 型号	OEM # 原装型号	Len. 长度
 SCM8	 SCN49	Nellcor non-oximax	SP0209	5720084	2.2m
 SCN09	 SCN49	Nellcor non-oximax	SP0209A	4533840	2.2m
 SCN10	 SCN49	Nellcor non-oximax	SP0209B	3375834/3368433	2.2m



GE-Corometrics Adapter Cables 科洛血氧转接线

Monitor side conn. P/N 监护仪端接头	Sensor side conn. P/N 探头端接头	Use with sensor 适用于	Sino-K P/N 型号	OEM # 原装型号	Len. 长度
 SCN11	 SCN49	Nellcor non-oximax	SP0210	4033CAX	2.2m









GE-Datex Ohmeda Adapter Cables 德恩血氧转接线

Monitor side conn. P/N 监护仪端接头	Sensor side conn. P/N 探头端接头	Use with sensor 适用于	Sino-K P/N 型号	OEM # 原装型号	Len. 长度
 SCN12	 SCN49	Datex sensor	SP0210B	OXY-C3	2.2m
 SCN12	 SCN54	OXY-TIP	SP0210P	OXY-SL3	2.2m











GE-Hellige Adapter Cables 海力格血氧转接线

Monitor side conn. P/N 监护仪端接头	Sensor side conn. P/N 探头端接头	Use with sensor 适用于	Sino-K P/N 型号	OEM # 原装型号	Len. 长度
 SCN13	 SCN49	Nellcor non-oximax	SP0210D	30344358	2.2m









GE-Ohmeda Adapter Cables 欧美达血氧转接线

Monitor side conn. P/N 监护仪端接头	Sensor side conn. P/N 探头端接头	Use with sensor 适用于	Sino-K P/N 型号	OEM # 原装型号	Len. 长度
 SCN16	 SCN49	Ohmeda	SP0210H		2.2m
 SCN15	 SCN54	OXY-TIP	SP0210K	OXY-ES3	2.2m
 SCN18	 SCN54	OXY-TIP	SP0210M	OXY-MC3	2.2m
 SCN16	 SCN54	OXY-TIP	SP0210Q	OXY-OL3	2.2m









GE-Marquette Adapter Cables 马奎血氧转接线

Monitor side conn. P/N 监护仪端接头	Sensor side conn. P/N 探头端接头	Use with sensor 适用于	Sino-K P/N 型号	OEM # 原装型号	Len. 长度
 SCN14	 SCN49	Nellcor non-oximax	SP0210E	2006644-001 E9004GE	2.2m
 SCN15	 SCN49	Nellcor oximax	SP0210F	2021406-001	2.2m
 SCN15	 SCN49	Nellcor non-oximax	SP0210G	Masim tech	2.2m
 SCN15	 SCN49	Masim LNCS	SP0210GM	2027263-002 (REF 2016)	2.2m
 SCN15	 SCN55	Masim LNOP	SP0210S	PC-12-GE	2.2m





GE-Trusignal Adapter Cables 血氧转接线

Monitor side conn. P/N 监护仪端接头	Sensor side conn. P/N 探头端接头	Use with sensor 适用于	Sino-K P/N 型号	OEM # 原装型号	Len. 长度
 SCN15	 SCN57	GE trusignal	P0210KT	TS-G3	2.2m
 SCN18	 SCN57	GE trusignal	P0210MT	TS-M3	2.2m
 SCN16	 SCN56	GE trusignal	P0210QS	TS-H3	2.2m
 SCN12	 SCN56	GE trusignal	P0210PS	TS-N3	2.2m





Goldway/Pace Tech/Generra Adapter Cables 金科威血氧转接线

Monitor side conn. P/N 监护仪端接头	Sensor side conn. P/N 探头端接头	Use with sensor 适用于	Sino-K P/N 型号	OEM # 原装型号	Len. 长度
 SCM5	 SCN49	Nellcor non-oximax/BCI	SP0211		2.2m
 SCP5	 SCN49	Nellcor non-oximax/BCI	SP0211A		2.2m
 SCP7	 SCN49	Nellcor non-oximax/BCI	SP0211		2.2m
 SCN19	 SCN49	Nellcor non-oximax/BCI	SP0211C		2.2m

Invivo Adapter Cables 英威血氧转接线

Monitor side conn. P/N 监护仪端接头	Sensor side conn. P/N 探头端接头	Use with sensor 适用于	Sino-K P/N 型号	OEM # 原装型号	Len. 长度
 SCM7	 SCN49	Nellcor non-oximax	SP0212		2.2m
 SCM7	 SCN49	Nellcor non-oximax	SP0212A	Masim tech.	2.2m
 SCM7	 SCN49	Masim LNCS	SP0212AM	Masim tech.	2.2m









Kontron Adapter Cables 康强血氧转接线

Monitor side conn. P/N 监护仪端接头	Sensor side conn. P/N 探头端接头	Use with sensor 适用于	Sino-K P/N 型号	OEM # 原装型号	Len. 长度
 SCN20	 SCN49	Nellcor non-oximax/BCI	SP0213		2.2m
 SCP7T	 SCN49	Nellcor non-oximax	SP0213A		2.2m







Masim Adapter Cables 迈心诺血氧转接线

Monitor side conn. P/N 监护仪端接头	Sensor side conn. P/N 探头端接头	Use with sensor 适用于	Sino-K P/N 型号	OEM # 原装型号	Len. 长度
 SCN22	 SCN49	Nellcor non-oximax/BCI	SP0215	Masim tech	2.2m
 SCN22	 SCN49	MASIM LNCS	SP0215M	1814/LNC-10	2.2m
 SCN22	 SCN55	MASIM LNOP	SP0215B	Masim 1005/PC08	2.2m
 SCN80	 SCN49	Masim LNCS	SP0215G	2059/RED LNC-10	2.2m
 SCN80	 SCN58	MASIM M-LNCS™	SP0215H		2.2m

Mennen Adapter Cables 美能血氧转接线

Monitor side conn. P/N 监护仪端接头	Sensor side conn. P/N 探头端接头	Use with sensor 适用于	Sino-K P/N 型号	OEM # 原装型号	Len. 长度
 SCN10	 SCN49	Nellcor non-oximax	SP0217		2.2m
 SCN25	 SCN49	Nellcor non-oximax	SP0217A		2.2m
 SCN26	 SCN49	Nellcor non-oximax	SP0217B		2.2m
 SCN26	 SCN49	Masim LNCS	SP0217BM		2.2m
 SCN26	 SCN55	Masim LNOP	SP0217C		2.2m

MEK Adapter Cables 血氧转接线

Monitor side conn. P/N 监护仪端接头	Sensor side conn. P/N 探头端接头	Use with sensor 适用于	Sino-K P/N 型号	OEM # 原装型号	Len. 长度
 SCN65	 SCN49	CSI	SP0216A		2.2m
 SCN65	 SCN49	Nellcor non-oximax /BCI	SP0216B		2.2m
 SCN66	 SCN49	MEK	SP0216C		2.2m

Mindray Adapter Cables 迈瑞血氧转接线

Monitor side conn. P/N 监护仪端接头	Sensor side conn. P/N 探头端接头	Use with sensor 适用于	Sino-K P/N 型号	OEM # 原装型号	Len. 长度
 SCN39	 SCN49	Nellcor non-oximax /BCI	SP0218	0515-30-11221	2.2m
 SCN39	 SCN49	Nellcor non-oximax /BCI	SP0218A	Masim tech.	2.2m
 SCN39	 SCN49	Masim LNCS	SP0218AM	0010-30-12452	2.2m
 SCM5	 SCN49	Nellcor non-oximax /BCI	SP0218B	512A-30-06074	2.2m
 SCP5	 SCN49	Nellcor non-oximax /BCI	SP0218C		2.2m
 SCP6	 SCN49	Nellcor non-oximax /BCI	SP0218D		2.2m
 SCP6R	 SCN49	Nellcor non-oximax /BCI	SP0218E	0010-20-42594	2.2m









Mindray Adapter Cables 迈瑞血氧转接线

Monitor side conn. P/N 监护仪端接头	Sensor side conn. P/N 探头端接头	Use with sensor 适用于	Sino-k P/N 型号	OEM # 原装	Len. 长度
 SCP6R	 SCN49	Nellcor non-oximax /BCI	SP0218F	Masim tech.	2.2m
 SCP6R	 SCN49	Masim LNCS	SP0218FM	0010-30-42602	2.2m
 SCP6S	 SCN49	Masim LNCS	SP0218GM	0010-30-42625	2.2m
 SCN27	 SCN49	Nellcor non-oximax /BCI	SP0218H	0010-20-42710	2.2m
 SCN28	 SCN49	Nellcor non-oximax /BCI	SP0218J	0515-30-11221	2.2m
 SCN28	 SCN49	Masim LNCS	SP0218JM		2.2m
 SCN29	 SCN49	Nellcor oximax	SP0218K	0010-30-12452	2.2m
 SCP6R	 SCN55	MASIM LNOP	SP0218N	512A-30-06074	2.2m

Mindray-Datascope Adapter Cables 血氧转接线

Monitor side conn. P/N 监护仪端接头	Sensor side conn. P/N 探头端接头	Use with sensor 适用于	Sino-K P/N 型号	OEM # 原装型号	Len. 长度
 SCN07	 SCN49	Datascope	SP0208	0012-00-0516-02	2.2m
 SCN22	 SCN55	MASIM LNOP	SP0215B	0012-00-1099-01	2.2m





Nellcor Adapter Cables 血氧转接线

Monitor side conn. P/N 监护仪端接头	Sensor side conn. P/N 探头端接头	Use with sensor 适用于	Sino-K P/N 型号	OEM # 原装型号	Len. 长度
 SCN30	 SCN49	Nellcor oximax /non-oximax	SP0219	DEC-8/EC-8 /DEC-4/EC-4	2.2m
		Nellcor non-oximax /BCI	SP0019A	Oximax adapter	---
 SCN31	 SCN51	Nellcor non-oximax /BCI	SP0219A	Oximax cable	2.2m
 SCN22	 SCN49	Nellcor non-oximax	SP0219B	SCP-10/MC-10	2.2m
 SCN46	 SCN51	Nellcor oximax	SP0319C	DOC-10	3.0m



Nihon Kohden Adapter Cables 光电血氧转接线

Monitor side conn. P/N 监护仪端接头	Sensor side conn. P/N 探头端接头	Use with sensor 适用于	Sino-K P/N 型号	OEM # 原装型号	Len. 长度
 SCN32	 SCN52	DB9 N.K sensor	SP0221		2.2m
 SCN34	 SCN52	DB9 N.K sensor	SP0221B	JL-900P	2.2m

Nonin Adapter Cables 燕牌血氧转接线

Monitor side conn. P/N 监护仪端接头	Sensor side conn. P/N 探头端接头	Use with sensor 适用于	Sino-K P/N 型号	OEM # 原装型号	Len. 长度
 SCM6	 SCN49	Nonin sensor	SP0222		2.2m
 SCN35	 SCN49	Nonin sensor	SP0222A		2.2m



Novamatrix Adapter Cables 诺医血氧转接线

Monitor side conn. P/N 监护仪端接头	Sensor side conn. P/N 探头端接头	Use with sensor 适用于	Sino-K P/N 型号	OEM # 原装型号	Len. 长度
 SCN36	 SCN49	Novamatrix sensor	SP0223		2.2m

Philips-HP-Agilent Adapter Cables 飞利浦血氧转接线







Monitor side conn. P/N 监护仪端接头	Sensor side conn. P/N 探头端接头	Use with sensor 适用于	Sino-K P/N 型号	OEM # 原装型号	Len. 长度
 SCN39	 SCN49	Nellcor non-oximax	SP0225	M1900B	2.2m
 SCN40	 SCN53	Philips 8 pins sensor	SP0225A	M1941A	2.2m
 SCN41	 SCN55	Masim sensor	SP0225F	1847/LNOP MP12 Masim	2.2m
 SCN41	 SCN49	Nellcor non-oximax	SP0225B		2.2m
 SCN41	 SCN49	Masim LNCS sensor	SP0225BM	2281/LNC MP10 Masim	2.2m
 SCN39	 SCN53	Philips 8 pins sensor	SP0225C	M1940A	2.2m
 SCN40	 SCN49	Nellcor non-oximax	SP0225D	M1943A/ M1943AL	2.2m
 SCN40	 SCN49	Nellcor oximax	SP0225E	M1943NL	2.2m

Schiller/ODM/ Brucker Adapter Cables 席勒血氧转接线

Monitor side conn. P/N 监护仪端接头	Sensor side conn. P/N 探头端接头	Use with sensor 适用于	Sino-K P/N 型号	OEM # 原装型号	Len. 长度
 SCN42	 SCN49	BCI sensor	SP0226		2.2m







Schiller/ODM/ Brucker Adapter Cables 席勒血氧转接线

Monitor side conn. P/N 监护仪端接头	Sensor side conn. P/N 探头端接头	Use with sensor 适用于	Sino-K P/N 型号	OEM # 原装型号	Len. 长度
 SCN42	 SCN49	Nellcor Non-Oximax	SP0226A		2.2m
 SCN42	 SCN49	Masim LNCS sensor	SP0226AM		2.2m
 SCN43	 SCN49	BCI sensor	SP0226B		2.2m

Spacelabs Adapter Cables 太空血氧转接线

Monitor side conn. P/N 监护仪端接头	Sensor side conn. P/N 探头端接头	Use with sensor 适用于	Sino-K P/N 型号	OEM # 原装型号	Len. 长度
 SCN44	 SCN49	Nellcor Non-Oximax	SP0227	700-0002-00	2.2m
 SCN45	 SCN49	Nellcor Non-Oximax	SP0227A	700-0030-00	2.2m
 SCN48	 SCN49	Nellcor Non-Oximax	SP0227B		2.2m
 SCN48	 SCN49	Masim LNCS	SP0227BM	700-0906-00	2.2m
 SCN48	 SCN55	Masim LNOP	SP0227C		2.2m
 SCN72	 SCN49	Nellcor oximax	SP0227D		2.2m

Solaris/New Tech Adapter Cables 索莱瑞/纽泰克血氧转接线

Monitor side conn. P/N 监护仪端接头	Sensor side conn. P/N 探头端接头	Use with sensor 适用于	Sino-K P/N 型号	OEM # 原装型号	Len. 长度
 SCP5	 SCN49	DB9 digital sensor	SP0220		2.2m
 SCP6R	 SCN49	DB9 digital sensor	SP0220A		2.2m

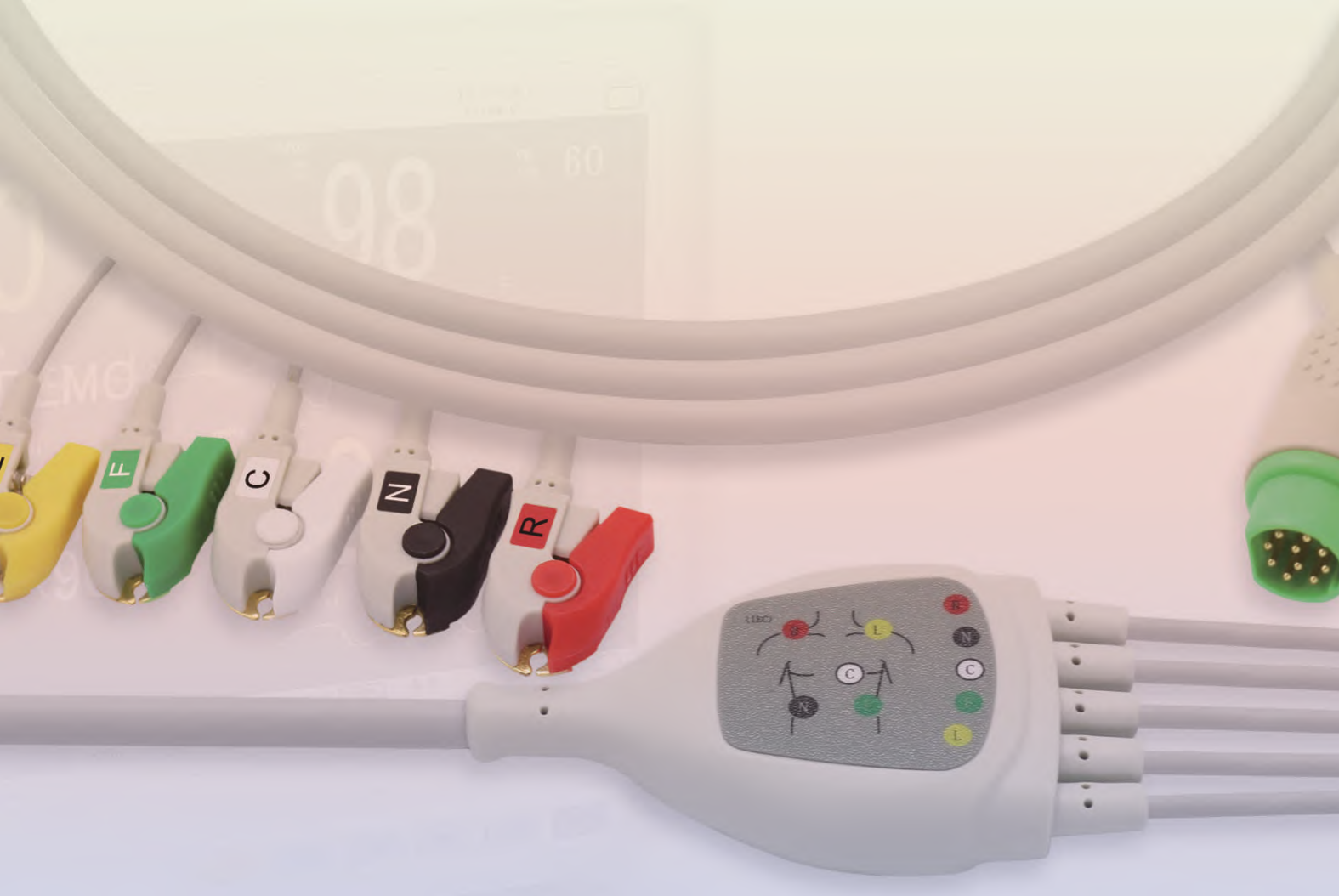

## ECG cables 心电导联线

### Certification 产品认证



医疗器械产品备案编号：粤深械备20180153号

医疗器械生产备案编号：粤深食药监械生产备20180045号

### Compliance with 符合标准

ANSI/AAMI EC53-1998(R)2001

EN 60601-1:1990

ISO10993-5-2009

ISO10993-10-2009

ISO 13485: 2016

## ECG CABLES&LEADWIRES 心电导联线











### Features and benefits

- ◆ Specially designed, fully shielded low noise medical TPU cable make show real signal  
全屏蔽低噪音定做TPU线材保证信号的真实性和真实性
- ◆ Use of latex free and biocompatible components  
使用具有生物兼容性和不含乳胶的原材料
- ◆ Different connectors available for ECG cable compatible to most patient monitors  
兼容大多数监护仪品牌
- ◆ Comfortable Easy to clean and disinfect by immersing or wiping with many popular disinfectant solutions  
舒适易于清洗和消毒

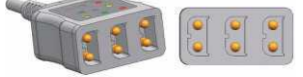

Product types 产品类型	Photo 图片	P/N Example 型号示例	P/N Guide 型号识别
Fixed one-piece ECG cable 一体化心电导联线		SG 5 1 01 S	S: Sino-K G: ECG cables 5: 5 leads (3: 3 leads) 1: AHA (2: IEC) 01: General (10: GE-DATEX; 12: GE-Marquette) S: fixed Snap (P: Fixed pinch)
Trunk cable 心电主电缆		SG 5 112 MQ	S: Sino-K G: ECG cables 5: 5 leads (3: 3 leads) 1: AHA (2: IEC) 12: GE-Marquette (10: GE-DATEX) MQ: MQ type
Leadwire 心电导联线		SG 3 1 1 AA	S: Sino-K G: ECG cables 3: 3 leads (5: 5 leads) 1: AHA (2: IEC) 1: Pinch (2: snap) AA: AA type
Warranty: six-month warranty for ECG cables, trunk cables and leadwires Package: 1pcs/bag 保修：6个月 包装：1个/包			

General 6 pins 普通6针

Models 监护仪型号	Connector 接头	Leads/label 导联数	Sino-K P/N 型号	OEM # 原装型号
Angle connector	 SCN151	3/AHA	SG3101DN	
	 SCN101	3/IEC	SG3201DN	
	 SCN152	5/AHA	SG5101DN	
	 SCN101	5/IEC	SG5201DN	
Straight connector	 SCN151	3/AHA	SG3140DN	
	 SCN101A	3/IEC	SG3240DN	
	 SCN152	5/AHA	SG5140DN	
	 SCN101A	5/IEC	SG5240DN	
LL style	 SCN154	3/AHA	SG3140LL	
	 SCN101A	3/IEC	SG3240LL	

General 6 pins 普通6针

Models 监护仪型号	Connector 接头	Leads/label 导联数	Sino-K P/N 型号	OEM # 原装型号
LL style	 SCN155	5/AHA	SG5140LL	
	 SCN101A	5/IEC	SG5240LL	
Straight connector	 SCN153	3/AHA Leadwire-Pinch 夹式导联线	SG311DN	
		3/AHA Leadwire-Snap 扣式导联线	SG312DN	
		3/IEC Leadwire-Pinch 夹式导联线	SG321DN	
		3/IEC Leadwire-Snap 扣式导联线	SG322DN	
	 SCN153	5/AHA Leadwire-Pinch 夹式导联线	SG511DN	
		5/AHA Leadwire-Snap 扣式导联线	SG512DN	
		5/IEC Leadwire-Pinch 夹式导联线	SG521DN	
		5/IEC Leadwire-Snap 扣式导联线	SG522DN	
LL style	 SCN156	3/AHA Leadwire-Pinch 夹式导联线	SG311LL	
		3/AHA Leadwire-Snap 扣式导联线	SG312LL	
		3/IEC Leadwire-Pinch 夹式导联线	SG321LL	
		3/IEC Leadwire-Snap 扣式导联线	SG322LL	
LL style	 SCN156	5/AHA Leadwire-Pinch 夹式导联线	SG511LL	
		5/AHA Leadwire-Snap 扣式导联线	SG512LL	
		5/IEC Leadwire-Pinch 夹式导联线	SG521LL	
		5/IEC Leadwire-Snap 扣式导联线	SG522LL	

General 6 pins 普通6针

Models 监护仪型号	Connector 接头	Leads/label 导联数	Sino-K P/N 型号	OEM # 原装型号
Angle connector	SCN101	3/AHA Fixed-Pinch 夹式一体化	SG3101P	
		3/AHA Fixed-Snap 扣式一体化	SG3101S	
		3/IEC Fixed-Pinch 夹式一体化	SG3201P	
		3/IEC Fixed-Snap 扣式一体化	SG3201S	
	SCN101	5/AHA Fixed-Pinch 夹式一体化	SG5101P	
		5/AHA Fixed-Snap 扣式一体化	SG5101S	
		5/IEC Fixed-Pinch 夹式一体化	SG5201P	
		5/IEC Fixed-Snap 扣式一体化	SG5201S	
Straight connector	SCN101A	3/AHA Fixed-Pinch 夹式一体化	SG3140P	
		3/AHA Fixed-Snap 扣式一体化	SG3140S	
		3/IEC Fixed-Pinch 夹式一体化	SG3240P	
		3/IEC Fixed-Snap 扣式一体化	SG3240S	
Straight connector	SCN101A	5/AHA Fixed-Pinch 夹式一体化	SG5140P	
		5/AHA Fixed-Snap 扣式一体化	SG5140S	
		5/IEC Fixed-Pinch 夹式一体化	SG5240P	
		5/IEC Fixed-Snap 扣式一体化	SG5240S	
Normal 6 pins conn. With 1k resistor, Straight connector	SCN151	3/AHA	SG3141DN	
	SCN101A	3/IEC	SG3241DN	

General 6 pins with Resistor 普通6针带电阻

Models 监护仪型号	Connector 接头	Leads/label 导联数	Sino-K P/N 型号	OEM # 原装型号
Normal 6 pins conn. With 1k resistor, Straight connector	SCN152	5/AHA	SG5141DN	
	SCN101A	5/IEC	SG5241DN	

General 6 pins with Resistor 普通6针带电阻

Models 监护仪型号	Connector 接头	Leads/label 导联数	Sino-K P/N 型号	OEM # 原装型号
Normal 6 pins conn. With 1k resistor, Straight connector	SCN101A	3/AHA Fixed-Pinch 夹式一体化	SG3141P	
		3/AHA Fixed-Snap 扣式一体化	SG3141S	
		3/IEC Fixed-Pinch 夹式一体化	SG3241P	
		3/IEC Fixed-Snap 扣式一体化	SG3241S	
	SCN101A	5/AHA Fixed-Pinch 夹式一体化	SG5141P	
		5/AHA Fixed-Snap 扣式一体化	SG5141S	
		5/IEC Fixed-Pinch 夹式一体化	SG5241P	
		5/IEC Fixed-Snap 扣式一体化	SG5241S	



Artema-S/W ECG CABLES&LEADWIRES 阿提玛心电导联线

Models 监护仪型号	Connector 接头	Leads/label 导联数	Sino-K P/N 型号	OEM # 原装型号
Normal 6 pins conn. With 1k resistor, Straight connector	SCN102	3/AHA Fixed-Pinch 夹式一体化	SG3103P	
		3/AHA Fixed-Snap 扣式一体化	SG3103S	
		3/IEC Fixed-Pinch 夹式一体化	SG3203P	
		3/IEC Fixed-Snap 扣式一体化	SG3203S	

Bionet ECG CABLES&LEADWIRES 心电导联线

Models 监护仪型号	Connector 接头	Leads/label 导联数	Sino-K P/N 型号	OEM # 原装型号
BM3	 SCN103	3/AHA Fixed-Pinch 夹式一体化	SG3104P	
		3/AHA Fixed-Snap 扣式一体化	SG3104S	
		3/IEC Fixed-Pinch 夹式一体化	SG3204P	
		3/IEC Fixed-Snap 扣式一体化	SG3204S	
	 SCN103	5/AHA Fixed-Pinch 夹式一体化	SG5104P	
		5/AHA Fixed-Snap 扣式一体化	SG5104S	
		5/IEC Fixed-Pinch 夹式一体化	SG5204P	
		5/IEC Fixed-Snap 扣式一体化	SG5204S	

Biosys ECG CABLES&LEADWIRES 心电导联线

Models 监护仪型号	Connector 接头	Options 探头类型	Sino-K P/N 型号	OEM # 原装型号
	 SCP6-F5	3/AHA Fixed-Pinch 夹式一体化	SG3105P	
		3/AHA Fixed-Snap 扣式一体化	SG3105S	
		3/IEC Fixed-Pinch 夹式一体化	SG3205P	
		3/IEC Fixed-Snap 扣式一体化	SG3205S	
	 SCP6-F5	5/AHA Fixed-Pinch 夹式一体化	SG5105P	
		5/AHA Fixed-Snap 扣式一体化	SG5105S	
		5/IEC Fixed-Pinch 夹式一体化	SG5205P	
		5/IEC Fixed-Snap 扣式一体化	SG5205S	

Colin ECG CABLES&LEADWIRES 科林心电导联线

Models 监护仪型号	Connector 接头	Leads/label 导联数	Sino-K P/N 型号	OEM # 原装型号
BP 88 - 306 - 508 Plastic connector	 SCN104	3/AHA Fixed-Pinch 夹式一体化	SG3106P	
		3/AHA Fixed-Snap 扣式一体化	SG3106S	







Colin ECG CABLES&LEADWIRES 科林心电导联线

Models 监护仪型号	Connector 接头	Leads/label 导联数	Sino-K P/N 型号	OEM # 原装型号
BP 88 - 306 - 508 Plastic connector	 SCN104	3/IEC Fixed-Pinch 夹式一体化	SG3206P	
		3/IEC Fixed-Snap 扣式一体化	SG3206S	
	 SCN104	5/AHA Fixed-Pinch 夹式一体化	SG5106P	
		5/AHA Fixed-Snap 扣式一体化	SG5106S	
		5/IEC Fixed-Pinch 夹式一体化	SG5206P	
		5/IEC Fixed-Snap 扣式一体化	SG5206S	
Mental L connector	 SCN105	3/AHA Fixed-Pinch 夹式一体化	SG3107P	
		3/AHA Fixed-Snap 扣式一体化	SG3107S	
		3/IEC Fixed-Pinch 夹式一体化	SG3207P	
		3/IEC Fixed-Snap 扣式一体化	SG3207S	
		5/AHA Fixed-Pinch 夹式一体化	SG5107P	
	 SCN105	5/AHA Fixed-Snap 扣式一体化	SG5105S	
		5/IEC Fixed-Pinch 夹式一体化	SG5207P	
		5/IEC Fixed-Snap 扣式一体化	SG5207S	

Drager-Siemens ECG CABLES&LEADWIRES 德尔格-西门子心电导联线

Models 监护仪型号	Connector 接头	Leads/label 导联数	Sino-K P/N 型号	OEM # 原装型号
Sirecust 341-342 R Series 200-400-600- 700-900-1200	 SCN159 SCN106	3/AHA	SG3108DR	
		3/IEC	SG3208DR	





Drager-Siemens ECG CABLES&LEADWIRES 德尔格-西门子心电导联线

Models 监护仪型号	Connector 接头	Sino-K P/N 型号	OEM # 原装型号	
Sirecust 341-342 R Series 200-400-600- 700-900-1200	 SCN160	5/AHA	SG5108DR	
	 SCN106	5/IEC	SG5208DR	
Sirecust 341-342 R Series 200-400-600- 700-900-1200	 SCN161	3/AHA Leadwire-Pinch 夹式导联线	SG311DR	
		3/AHA Leadwire-Snap 扣式导联线	SG312DR	
		3/IEC Leadwire-Pinch 夹式导联线	SG321DR	
		3/IEC Leadwire-Snap 扣式导联线	SG322DR	
	 SCN162	5/AHA Leadwire-Pinch 夹式导联线	SG511DR	5956490
		5/AHA Leadwire-Snap 扣式导联线	SG512DR	
Sirecust 341-342 R Series 200-400-600- 700-900-1200	 SCN106	5/IEC Leadwire-Pinch 夹式导联线	SG521DR	5956508
		5/IEC Leadwire-Snap 扣式导联线	SG522DR	
		3/AHA Fixed-Pinch 夹式一体化	SG3108P	
		3/AHA Fixed-Snap 扣式一体化	SG3108S	
	 SCN106	3/IEC Fixed-Pinch 夹式一体化	SG3208P	
		3/IEC Fixed-Snap 扣式一体化	SG3208S	
		5/AHA Fixed-Pinch 夹式一体化	SG5108P	
		5/AHA Fixed-Snap 扣式一体化	SG5108S	
	 SCN106	5/IEC Fixed-Pinch 夹式一体化	SG5208P	
		5/IEC Fixed-Snap 扣式一体化	SG5208S	



Drager-Siemens ECG CABLES&LEADWIRES 德尔格-西门子心电导联线

Models 监护仪型号	Connector 接头	Leads/label 导联数	Sino-K P/N 型号	OEM # 原装型号
SC5000, SC6000, SC7000, SC8000, SC9000.	 SCN128	3/AHA Fixed-Pinch 夹式一体化	SG3131P	
		3/AHA Fixed-Snap 扣式一体化	SG3131S	
		3/IEC Fixed-Pinch 夹式一体化	SG3231P	
		3/IEC Fixed-Snap 扣式一体化	SG3231S	





Fukuda Denshi ECG CABLES&LEADWIRES 福田心电导联线

Models 监护仪型号	Connector 接头	Leads/label 导联数	Sino-K P/N 型号	OEM # 原装型号
	 SCN160	5/AHA	SG5109DR	
		5/IEC	SG5209DR	
DS-7000 DS-7100 DS-7200 DS-7300	 SCN162	5/AHA Leadwire-Pinch 夹式导联线	SG511DR	
		5/AHA Leadwire-Snap 扣式导联线	SG512DR	
		5/IEC Leadwire-Pinch 夹式导联线	SG521DR	
		5/IEC Leadwire-Snap 扣式导联线	SG522DR	
	 SCN107	5/AHA Fixed-Pinch 夹式一体化	SG5109P	
		5/AHA Fixed-Snap 扣式一体化	SG5109S	
		5/IEC Fixed-Pinch 夹式一体化	SG5209P	
		5/IEC Fixed-Snap 扣式一体化	SG5209S	
DS-5300W DS-5100E DS-7001	 SCN123	3/AHA Fixed-Pinch 夹式一体化	SG3133P	
		3/AHA Fixed-Snap 扣式一体化	SG3133S	



Fukuda Denshi ECG CABLES&LEADWIRES 福田心电导联线

Models 监护仪型号	Connector 接头	Leads/label 导联数	Sino-K P/N 型号	OEM # 原装型号
DS-5300W DS-5100E DS-7001	 SCN123	3/IEC Fixed-Pinch 夹式一体化	SG3233P	
		3/IEC Fixed-Snap 扣式一体化	SG3233S	
	 SCN123	5/AHA Fixed-Pinch 夹式一体化	SG5133P	
		5/AHA Fixed-Snap 扣式一体化	SG5133S	
		5/IEC Fixed-Pinch 夹式一体化	SG5233P	
		5/IEC Fixed-Snap 扣式一体化	SG5233S	

GE-Critikon ECG CABLES&LEADWIRES 强生心电导联线

Models 监护仪型号	Connector 接头	Leads/label 导联数	Sino-K P/N 型号	OEM # 原装型号
Series 8700 - Dinamap + Dinamap MPS Select Dinamap MPS Select Portable	 SCN163	3/AHA	SG3102DX	
	 SCN101	3/IEC	SG3202DX	
	 SCN164	5/AHA	SG5102DX	
	 SCN101	5/IEC	SG5202DX	
Series 8700 - Dinamap + Dinamap MPS Select Dinamap MPS Select Portable	 SCN165	3/AHA Leadwire-Pinch 夹式导联线	SG311DX	
		3/AHA Leadwire-Snap 扣式导联线	SG312DX	
		3/IEC Leadwire-Pinch 夹式导联线	SG321DX	
		3/IEC Leadwire-Snap 扣式导联线	SG322DX	





GE-Critikon ECG CABLES&LEADWIRES 强生心电导联线

Models 监护仪型号	Connector 接头	Leads/label 导联数	Sino-K P/N 型号	OEM # 原装型号
Series 8700 - Dinamap + Dinamap MPS Select Dinamap MPS Select Portable	 SCN166	5/AHA Leadwire-Pinch 夹式导联线	SG511DX	
		5/AHA Leadwire-Snap 扣式导联线	SG512DX	
		5/IEC Leadwire-Pinch 夹式导联线	SG521DX	
		5/IEC Leadwire-Snap 扣式导联线	SG522DX	
	 SCN101	3/AHA Fixed-Pinch 夹式一体化	SG3102P	
		3/AHA Fixed-Snap 扣式一体化	SG3102S	
		3/IEC Fixed-Pinch 夹式一体化	SG3202P	
		3/IEC Fixed-Snap 扣式一体化	SG3202S	
	 SCN101	5/AHA Fixed-Pinch 夹式一体化	SG5102P	
		5/AHA Fixed-Snap 扣式一体化	SG5102S	
		5/IEC Fixed-Pinch 夹式一体化	SG5202P	
		5/IEC Fixed-Snap 扣式一体化	SG5202S	

GE-Datex Ohmeda ECG CABLES&LEADWIRES 德恩心电导联线

Models 监护仪型号	Connector 接头	Leads/label 导联数	Sino-K P/N 型号	OEM # 原装型号
AS/3, CS/3, Cardiocap 1, Cardiocap 2, Cardiocap 5, S/5, Satellite Plus	 SCN163	3/AHA	SG3110DX	545302 545307
	 SCN125	3/IEC	SG3210DX	545305 545300 545304
	 SCN164	5/AHA	SG5110DX	545303 545308
	 SCN125	5/IEC	SG5210DX	545301 545306







GE-Datex Ohmeda ECG CABLES&LEADWIRES 德思心电导联线

Models 监护仪型号	Connector 接头	Leads/label 导联数	Sino-K P/N 型号	OEM # 原装型号
AS/3, CS/3, Cardiocard 1, Cardiocard 2, Cardiocard 5, S/5, Satellite Plus	 SCN165	3/AHA Leadwire-Pinch 夹式导联线	SG311DX	8001958 545317
		3/AHA Leadwire-Snap 扣式导联线	SG312DX	545327
		3/IEC Leadwire-Pinch 夹式导联线	SG321DX	8001960 545315
		3/IEC Leadwire-Snap 扣式导联线	SG322DX	
	 SCN166	5/AHA Leadwire-Pinch 夹式导联线	SG511DX	8001959 545318
		5/AHA Leadwire-Snap 扣式导联线	SG512DX	545328
		5/IEC Leadwire-Pinch 夹式导联线	SG521DX	8001961 545316
		5/IEC Leadwire-Snap 扣式导联线	SG522DX	
	 SCN125	3/AHA Fixed-Pinch 夹式一体化	SG3110P	
		3/AHA Fixed-Snap 扣式一体化	SG3110S	
		3/IEC Fixed-Pinch 夹式一体化	SG3210P	
		3/IEC Fixed-Snap 扣式一体化	SG3210S	
	 SCN125	5/AHA Fixed-Pinch 夹式一体化	SG5110P	
		5/AHA Fixed-Snap 扣式一体化	SG5110S	
		5/IEC Fixed-Pinch 夹式一体化	SG5210P	
		5/IEC Fixed-Snap 扣式一体化	SG5210S	

GE-Hellige ECG CABLES&LEADWIRES 海力格心电导联线







Models 监护仪型号	Connector 接头	Leads/label 导联数	Sino-K P/N 型号	OEM # 原装型号
Eagle 1000, Def. SCP 900, Cardioserv, SMC, SMS, SMK, SMU, SMV.	 SCN163	3/AHA	SG3111DX	
	 SCN108	3/IEC	SG3211DX	

GE-Hellige ECG CABLES&LEADWIRES 海力格心电导联线

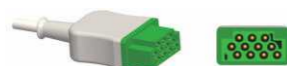

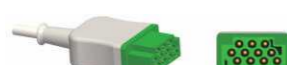
Models 监护仪型号	Connector 接头	Leads/label 导联数	Sino-K P/N 型号	OEM # 原装型号
Eagle 1000, Def. SCP 900, Cardioserv, SMC, SMS, SMK, SMU, SMV.	 SCN164	5/AHA	SG5111DX	
	 SCN108	5/IEC	SG5211DX	
Eagle 1000, Def. SCP 900, Cardioserv, SMC, SMS, SMK, SMU, SMV.	 SCN165	3/AHA Leadwire-Pinch 夹式导联线	SG311DX	
		3/AHA Leadwire-Snap 扣式导联线	SG312DX	
		3/IEC Leadwire-Pinch 夹式导联线	SG321DX	
		3/IEC Leadwire-Snap 扣式导联线	SG322DX	
	 SCN166	5/AHA Leadwire-Pinch 夹式导联线	SG511DX	
		5/AHA Leadwire-Snap 扣式导联线	SG512DX	
		5/IEC Leadwire-Pinch 夹式导联线	SG521DX	
		5/IEC Leadwire-Snap 扣式导联线	SG522DX	
	 SCN108	3/AHA Fixed-Pinch 夹式一体化	SG3111P	
		3/AHA Fixed-Snap 扣式一体化	SG3111S	
		3/IEC Fixed-Pinch 夹式一体化	SG3211P	
		3/IEC Fixed-Snap 扣式一体化	SG3211S	
	 SCN108	5/AHA Fixed-Pinch 夹式一体化	SG5111P	
		5/AHA Fixed-Snap 扣式一体化	SG5111S	
		5/IEC Fixed-Pinch 夹式一体化	SG5211P	
		5/IEC Fixed-Snap 扣式一体化	SG5211S	



GE-Marquette ECG CABLES&LEADWIRES 马奎心电导联线

Models 监护仪型号	Connector 接头	Leads/label 导联数	Sino-K P/N 型号	OEM # 原装型号
Dash 2000/3000/4000, Dinamap PRO 1000, Eagle Systems, MAC-Lab, Solar 3000/8000/9500, Tram 100/200/300/400 /500/600/800/Tram AR, Unity Systems	 SCN167	3/AHA	SG3112MQ	412931-001 412931-021
	 SCN109	3/IEC	SG3212MQ	2017003-003 412931-002
	 SCN167	5/AHA	SG5112MQ	
	 SCN109	5/IEC	SG5212MQ	
	 SCN251	10/AHA	SG1112MQ	
	 SCN109	10/IEC	SG1212MQ	
Dash 2000/3000/4000, Dinamap PRO 1000, Eagle Systems, MAC-Lab, Solar 3000/8000/9500, Tram 100/200/300/400 /500/600/800/Tram AR, Unity Systems	 SCN168	3/AHA Leadwire-Pinch 夹式导联线	SG311MQ	412682-001 412682-002
		3/AHA Leadwire-Snap 扣式导联线	SG312MQ	411203-001 411203-002
		3/IEC Leadwire-Pinch 夹式导联线	SG321MQ	412682-003 412682-004
		3/IEC Leadwire-Snap 扣式导联线	SG322MQ	411203-003 411203-004
	 SCN168	5/AHA Leadwire-Pinch 夹式导联线	SG511MQ	412681-001 412681-002
		5/AHA Leadwire-Snap 扣式导联线	SG512MQ	412681-003 412681-004
		5/IEC Leadwire-Pinch 夹式导联线	SG521MQ	
		5/IEC Leadwire-Snap 扣式导联线	SG522MQ	

GE-Marquette ECG CABLES&LEADWIRES 马奎心电导联线

Models 监护仪型号	Connector 接头	Leads/label 导联数	Sino-K P/N 型号	OEM # 原装型号
Dash 2000/3000/4000, Dinamap PRO 1000, Eagle Systems, MAC-Lab, Solar 3000/8000/9500, Tram 100/200/300/400/500/600 /800/Tram AR, Unity Systems	 SCN109	3/AHA Fixed-Pinch 夹式一体化	SG3112P	
		3/AHA Fixed-Snap 扣式一体化	SG3112S	
		3/IEC Fixed-Pinch 夹式一体化	SG3212P	
		3/IEC Fixed-Snap 扣式一体化	SG3212S	
	 SCN109	5/AHA Fixed-Pinch 夹式一体化	SG5112P	
		5/AHA Fixed-Snap 扣式一体化	SG5112S	
		5/IEC Fixed-Pinch 夹式一体化	SG5212P	
		5/IEC Fixed-Snap 扣式一体化	SG5212S	

Huntleigh Healthcare ECG CABLES&LEADWIRES 心电导联线

Models 监护仪型号	Connector 接头	Leads/label 导联数	Sino-K P/N 型号	OEM # 原装型号
	 SCP8-F5	3/AHA Fixed-Pinch 夹式一体化	SG3142P	
		3/AHA Fixed-Snap 扣式一体化	SG3142S	
		3/IEC Fixed-Pinch 夹式一体化	SG3242P	
		3/IEC Fixed-Snap 扣式一体化	SG3242S	



Kontron ECG CABLES&LEADWIRES 康强心电导联线

Models 监护仪型号	Connector 接头	Leads/label 导联数	Sino-K P/N 型号	OEM # 原装型号
Micromon, Minimon, Vitalmon, Supermon, Kolormon	 SCN110	3/AHA Fixed-Pinch 夹式一体化	SG3113P	
		3/AHA Fixed-Snap 扣式一体化	SG3113S	
		3/IEC Fixed-Pinch 夹式一体化	SG3213P	
		3/IEC Fixed-Snap 扣式一体化	SG3213S	





Kontron ECG CABLES&LEADWIRES 康强心电导联线

Models 监护仪型号	Connector 接头	Leads/label 导联数	Sino-K P/N 型号	OEM # 原装型号
105, 107, 108, 125, 128, VSM510 Old generation	 SCN36	3/AHA Fixed-Pinch 夹式一体化	SG3114P	
		3/AHA Fixed-Snap 扣式一体化	SG3114S	
		3/IEC Fixed-Pinch 夹式一体化	SG3214P	
		3/IEC Fixed-Snap 扣式一体化	SG3214S	





Medtronic-Physio Control ECG CABLES&LEADWIRES 美敦力心电导联线

Models 监护仪型号	Connector 接头	Leads/label 导联数	Sino-K P/N 型号	OEM # 原装型号
Lifepak5,6,7,8,9 (See General(Resistor))		3/AHA Fixed-Pinch 夹式一体化		
		3/AHA Fixed-Snap 扣式一体化		
		5/IEC Fixed-Pinch 夹式一体化		
		5/IEC Fixed-Snap 扣式一体化		
Lifepak 15, 20	 SCN111	3/AHA Fixed-Pinch 夹式一体化	SG3115P	
		3/AHA Fixed-Snap 扣式一体化	SG3115S	
		3/IEC Fixed-Pinch 夹式一体化	SG3215P	
		3/IEC Fixed-Snap 扣式一体化	SG3215S	
	 SCN111	5/AHA Fixed-Pinch 夹式一体化	SG5115P	
		5/AHA Fixed-Snap 扣式一体化	SG5115S	
		5/IEC Fixed-Pinch 夹式一体化	SG5215P	
		5/IEC Fixed-Snap 扣式一体化	SG5215S	
 SCN111	10/AHA Fixed-Pinch 夹式一体化	SG1115P		
	10/AHA Fixed-Snap 扣式一体化	SG1115S		
	10/IEC Fixed-Pinch 夹式一体化	SG1215P		
	10/IEC Fixed-Snap 扣式一体化	SG1215S		



Mennen ECG CABLES&LEADWIRES 美能心电导联线

Models 监护仪型号	Connector 接头	Leads/label 导联数	Sino-K P/N 型号	OEM # 原装型号
Series 9000-1100-2000	 SCN173	3/AHA	SG3116MN	
		3/IEC	SG3216MN	
	 SCN112	5/AHA	SG5116MN	
		5/IEC	SG5216MN	
Envoy	 SCN173	3/AHA	SG3117MN	
		3/IEC	SG3217MN	
	 SCN113	5/AHA	SG5117MN	
		5/IEC	SG5217MN	
Series 9000-1100-2000	 SCN175	3/AHA Leadwire-Pinch 夹式导联线	SG311MN	
		3/AHA Leadwire-Snap 扣式导联线	SG312MN	
		3/IEC Leadwire-Pinch 夹式导联线	SG321MN	
		3/IEC Leadwire-Snap 扣式导联线	SG322MN	

Mennen ECG CABLES&LEADWIRES 美能心电导联线

Models 监护仪型号	Connector 接头	Leads/label 导联数	Sino-K P/N 型号	OEM # 原装型号
Series 9000-1100-2000		5/AHA Leadwire-Pinch 夹式导联线	SG511MN	
		5/AHA Leadwire-Snap 扣式导联线	SG512MN	
		5/IEC Leadwire-Pinch 夹式导联线	SG521MN	
		5/IEC Leadwire-Snap 扣式导联线	SG522MN	
Envoy		3/AHA Leadwire-Pinch 夹式导联线	SG311MN	
		3/AHA Leadwire-Snap 扣式导联线	SG312MN	
		3/IEC Leadwire-Pinch 夹式导联线	SG321MN	
		3/IEC Leadwire-Snap 扣式导联线	SG322MN	
		5/AHA Leadwire-Pinch 夹式导联线	SG511MN	
		5/AHA Leadwire-Snap 扣式导联线	SG512MN	
		5/IEC Leadwire-Pinch 夹式导联线	SG521MN	
		5/IEC Leadwire-Snap 扣式导联线	SG522MN	
Series 9000-1100-2000		3/AHA Fixed-Pinch 夹式一体化	SG3116P	
		3/AHA Fixed-Snap 扣式一体化	SG3116S	
		3/IEC Fixed-Pinch 夹式一体化	SG3216P	
		3/IEC Fixed-Snap 扣式一体化	SG3216S	
		5/AHA Fixed-Pinch 夹式一体化	SG5116P	
		5/AHA Fixed-Snap 扣式一体化	SG5116S	
		5/IEC Fixed-Pinch 夹式一体化	SG5216P	
		5/IEC Fixed-Snap 扣式一体化	SG5216S	

Mennen ECG CABLES&LEADWIRES 美能心电导联线

Models 监护仪型号	Connector 接头	Leads/label 导联数	Sino-K P/N 型号	OEM # 原装型号
Envoy		3/AHA Fixed-Pinch 夹式一体化	SG3117P	
		3/AHA Fixed-Snap 扣式一体化	SG3117S	
		3/IEC Fixed-Pinch 夹式一体化	SG3217P	
		3/IEC Fixed-Snap 扣式一体化	SG3217S	
		5/AHA Fixed-Pinch 夹式一体化	SG5117P	
		5/AHA Fixed-Snap 扣式一体化	SG5117S	
		5/IEC Fixed-Pinch 夹式一体化	SG5217P	
		5/IEC Fixed-Snap 扣式一体化	SG5217S	



Mindray ECG CABLES&LEADWIRES 迈瑞心电导联线

Models 监护仪型号	Connector 接头	Leads/label 导联数	Sino-K P/N 型号	OEM # 原装型号
6 pins with resistor 带电阻 PM-7000, PM-8000series, PM-9000series, new PM-6000		3/AHA	SG3141MD	0010-30-12257 0010-30-12246
		3/IEC	SG3241MD	0010-30-12247
		5/AHA	SG5141MD	0010-30-12244
		5/IEC	SG5241MD	0010-30-12245
12 pins, no resistor 12针不带电阻 PM-5000		3/AHA	SG3118MD	0010-30-12380 0010-30-12250
		3/IEC	SG3218MD	0010-30-12251

Mindray ECG CABLES&LEADWIRES 迈瑞心电导联线

Models 监护仪型号	Connector 接头	Leads/label 导联数	Sino-K P/N 型号	OEM # 原装型号
12 pins with resistor 12针带电阻 PM-6000	 SCN159	3/AHA	SG3124MD	0010-30-12379
	 SCN117	3/IEC	SG3224MD	0010-30-12379
	 SCN160	5/AHA	SG5124MD	0010-30-12260
	 SCN117	5/IEC	SG5224MD	0010-30-12260
	 SCN159	3/AHA	SG3143MD	0010-30-42719
	 SCN127	3/IEC	SG3243MD	0010-30-42719
12 pins with resistor 12针带电阻 BENEVIEW T5/T8	 SCN160	5/AHA	SG5143MD	0010-30-42719
	 SCN127	5/IEC	SG5243MD	0010-30-42719
	 SCN159	3/AHA	SG3140MD	0010-30-12378 0010-30-12242
	 SCN101	3/IEC	SG3240MD	0010-30-12243



Mindray ECG CABLES&LEADWIRES 迈瑞心电导联线

Models 监护仪型号	Connector 接头	Leads/label 导联数	Sino-K P/N 型号	OEM # 原装型号
6 pins with resistor 带电阻 PM-7000, PM-8000series, PM-9000series, new PM-6000	 SCN161	3/AHA Leadwire-Pinch 夹式导联线	SG311MD	0010-30-12263 0100-30-12388
		3/AHA Leadwire-Snap 扣式导联线	SG312MD	0010-30-12267
		3/IEC Leadwire-Pinch 夹式导联线	SG321MD	0010-30-12265 0100-30-12390
		3/IEC Leadwire-Snap 扣式导联线	SG322MD	0010-30-12269
	 SCN162	5/AHA Leadwire-Pinch 夹式导联线	SG511MD	0010-30-12262
		5/AHA Leadwire-Snap 扣式导联线	SG512MD	0010-30-12266
6 pins with resistor 带电阻 PM-7000, PM-8000series, PM-9000series, new PM-6000	 SCN101A	5/IEC Leadwire-Pinch 夹式导联线	SG521MD	0010-30-12264
		5/IEC Leadwire-Snap 扣式导联线	SG522MD	0010-30-12268
		3/AHA Fixed-Pinch 夹式一体化	SG3141P	
		3/AHA Fixed-Snap 扣式一体化	SG3141S	
	 SCN101A	3/IEC Fixed-Pinch 夹式一体化	SG3241P	
		3/IEC Fixed-Snap 扣式一体化	SG3241S	
		5/AHA Fixed-Pinch 夹式一体化	SG5141P	
		5/AHA Fixed-Snap 扣式一体化	SG5141S	
12 pins, no resistor 12针不带电阻 PM-5000	 SCN117	5/IEC Fixed-Pinch 夹式一体化	SG5241P	
		5/IEC Fixed-Snap 扣式一体化	SG5241S	
		3/AHA Fixed-Pinch 夹式一体化	SG3118P	
		3/AHA Fixed-Snap 扣式一体化	SG3118S	



Mindray ECG CABLES&LEADWIRES 迈瑞心电导联线

Models 监护仪型号	Connector 接头	Leads/label 导联数	Sino-K P/N 型号	OEM # 原装型号
12 pins with resistor 12针带电阻 PM-6000		3/AHA Fixed-Pinch 夹式一体化	SG3124P	
		3/AHA Fixed-Snap 扣式一体化	SG3124S	
		3/IEC Fixed-Pinch 夹式一体化	SG3224P	
		3/IEC Fixed-Snap 扣式一体化	SG3224S	
		5/AHA Fixed-Pinch 夹式一体化	SG5124P	
		5/AHA Fixed-Snap 扣式一体化	SG5124S	
		5/IEC Fixed-Pinch 夹式一体化	SG5224P	
		5/IEC Fixed-Snap 扣式一体化	SG5224S	
12 pins with resistor 12针带电阻 BENEVIEW T5/T8		3/AHA Fixed-Pinch 夹式一体化	SG3143P	
		3/AHA Fixed-Snap 扣式一体化	SG3143S	
		3/IEC Fixed-Pinch 夹式一体化	SG3243P	
		3/IEC Fixed-Snap 扣式一体化	SG3243S	
		5/AHA Fixed-Pinch 夹式一体化	SG5143P	
		5/AHA Fixed-Snap 扣式一体化	SG5143S	
		5/IEC Fixed-Pinch 夹式一体化	SG5243P	
		5/IEC Fixed-Snap 扣式一体化	SG5243S	
6 pins , no resistor 不带电阻 MEC1000, MEC1200		3/AHA Fixed-Pinch 夹式一体化	SG3140P	
		3/AHA Fixed-Snap 扣式一体化	SG3140S	
		3/IEC Fixed-Pinch 夹式一体化	SG3240P	
		3/IEC Fixed-Snap 扣式一体化	SG3240S	

Mediana ECG CABLES&LEADWIRES 心电导联线

Models 监护仪型号	Connector 接头	Leads/label 导联数	Sino-K P/N 型号	OEM # 原装型号
		3/AHA	SG3129DN	
		3/IEC	SG3229DN	
		3/AHA Fixed-Pinch 夹式一体化	SG3129P	
		3/AHA Fixed-Snap 扣式一体化	SG3129S	
		3/IEC Fixed-Pinch 夹式一体化	SG3229P	
		3/IEC Fixed-Snap 扣式一体化	SG3229S	

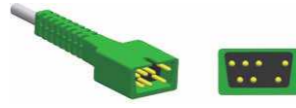
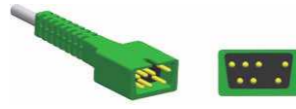





MEK ECG CABLES&LEADWIRES 心电导联线

Models 监护仪型号	Connector 接头	Leads/label 导联数	Sino-K P/N 型号	OEM # 原装型号
MP500,MP600,MP1000		3/AHA Fixed-Pinch 夹式一体化	SG3119P	
		3/AHA Fixed-Snap 扣式一体化	SG3119S	
		3/IEC Fixed-Pinch 夹式一体化	SG3219P	
		3/IEC Fixed-Snap 扣式一体化	SG3219S	
MP500,MP600,MP1000		5/AHA Fixed-Pinch 夹式一体化	SG5119P	
		5/AHA Fixed-Snap 扣式一体化	SG5119S	
		5/IEC Fixed-Pinch 夹式一体化	SG5219P	
		5/IEC Fixed-Snap 扣式一体化	SG5219S	
6 pins		3/AHA Fixed-Pinch 夹式一体化	SG3120P	
		3/AHA Fixed-Snap 扣式一体化	SG3120S	









MEK ECG CABLES&LEADWIRES 心电导联线

Models 监护仪型号	Connector 接头	Leads/label 导联数	Sino-K P/N 型号	OEM # 原装型号
6 pins	 SCN101B	3/IEC Fixed-Pinch 夹式一体化	SG3220P	
		3/IEC Fixed-Snap 扣式一体化	SG3220S	
	 SCN101B	5/AHA Fixed-Pinch 夹式一体化	SG5120P	
		5/AHA Fixed-Snap 扣式一体化	SG5120S	
		5/IEC Fixed-Pinch 夹式一体化	SG5220P	
		5/IEC Fixed-Snap 扣式一体化	SG5220S	





Nihon Kohden ECG CABLES&LEADWIRES 光电心电导联线

Models 监护仪型号	Connector 接头	Leads/label 导联数	Sino-K P/N 型号	OEM # 原装型号
Def. Cardiolife Lifescope series 6-8-9-11 6102-6205-6120	 SCN169	3/AHA	SG3121NH	
	 SCN114	3/IEC	SG3221NH	
	 SCN169	5/AHA	SG5121NH	
	 SCN114	5/IEC	SG5221NH	
BSM-2300 lifescope I, BSM-4100 lifescope P, BSM-5100 lifescope A, BSM-9510lifescope M, BSM-9800 lifescope S	 SCN171	3/AHA	SG3122NK	
	 SCN115	3/IEC	SG3222NK	



Nihon Kohden ECG CABLES&LEADWIRES 光电心电导联线

Models 监护仪型号	Connector 接头	Leads/label 导联数	Sino-K P/N 型号	OEM # 原装型号
BSM-2300 lifescope I, BSM-4100 lifescope P, BSM-5100 lifescope A, BSM-9510lifescope M, BSM-9800 lifescope S	 SCN171	6/AHA	SG6122NK	
	 SCN115	6/IEC	SG6222NK	
TEC-5521	 SCN169	3/AHA	SG3130NH	
	 SCN119	3/IEC	SG3230NH	
OPV-1500	 SCN171	3/AHA	SG3134NK	
	 SCN126	3/IEC	SG3234NK	
Def. Cardiolife Lifescope series 6-8-9-11 6102-6205-6120	 SCN170	3/AHA Leadwire-Pinch 夹式导联线	SG311NH	
		3/AHA Leadwire-Snap 扣式导联线	SG312NH	
		3/IEC Leadwire-Pinch 夹式导联线	SG321NH	
		3/IEC Leadwire-Snap 扣式导联线	SG322NH	
Def. Cardiolife Lifescope series 6-8-9-11 6102-6205-6120	 SCN170	5/AHA Leadwire-Pinch 夹式导联线	SG511NH	
		5/AHA Leadwire-Snap 扣式导联线	SG512NH	
		5/IEC Leadwire-Pinch 夹式导联线	SG521NH	
		5/IEC Leadwire-Snap 扣式导联线	SG522NH	

Nihon Kohden ECG CABLES&LEADWIRES 光电心电导联线

Models 监护仪型号	Connector 接头	Leads/label 导联数	Sino-K P/N 型号	OEM # 原装型号
BSM-2300 lifescope I, BSM-4100 lifescope P, BSM-5100 lifescope A, BSM-9510lifescope M, BSM-9800 lifescope S	 SCN172	3/AHA Leadwire-Pinch 夹式导联线	SG311NK	
		3/AHA Leadwire-Snap 扣式导联线	SG312NK	
		3/IEC Leadwire-Pinch 夹式导联线	SG321NK	
		3/IEC Leadwire-Snap 扣式导联线	SG322NK	
	 SCN172	6/AHA Leadwire-Pinch 夹式导联线	SG611NK	
		6/AHA Leadwire-Snap 扣式导联线	SG612NK	
		6/IEC Leadwire-Pinch 夹式导联线	SG621NK	
		6/IEC Leadwire-Snap 扣式导联线	SG622NK	
TEC-5521	 SCN170	3/AHA Leadwire-Pinch 夹式导联线	SG311NH	
		3/AHA Leadwire-Snap 扣式导联线	SG312NH	
		3/IEC Leadwire-Pinch 夹式导联线	SG321NH	
		3/IEC Leadwire-Snap 扣式导联线	SG322NH	
Def. Cardiolife Lifescope series 6-8-9-11 6102-6205-6120	 SCN114	3/AHA Fixed-Pinch 夹式一体化	SG3121P	
		3/AHA Fixed-Snap 扣式一体化	SG3121S	
		3/IEC Fixed-Pinch 夹式一体化	SG3221P	
		3/IEC Fixed-Snap 扣式一体化	SG3221S	
	 SCN114	5/AHA Fixed-Pinch 夹式一体化	SG5121P	
		5/AHA Fixed-Snap 扣式一体化	SG5121S	
		5/IEC Fixed-Pinch 夹式一体化	SG5221P	
		5/IEC Fixed-Snap 扣式一体化	SG5221S	

Nihon Kohden ECG CABLES&LEADWIRES 光电心电导联线

Models 监护仪型号	Connector 接头	Leads/label 导联数	Sino-K P/N 型号	OEM # 原装型号
BSM-2300 lifescope I, BSM-4100 lifescope P, BSM-5100 lifescope A, BSM-9510lifescope M, BSM-9800 lifescope S	 SCN115	3/AHA Fixed-Pinch 夹式一体化	SG3122P	
		3/AHA Fixed-Snap 扣式一体化	SG3122S	
		3/IEC Fixed-Pinch 夹式一体化	SG3222P	
		3/IEC Fixed-Snap 扣式一体化	SG3222S	
OPV-1500	 SCN126	3/AHA Fixed-Pinch 夹式一体化	SG3134P	
		3/AHA Fixed-Snap 扣式一体化	SG3134S	
		3/IEC Fixed-Pinch 夹式一体化	SG3234P	
		3/IEC Fixed-Snap 扣式一体化	SG3234S	





Philips-HP ECG CABLES&LEADWIRES 飞利浦心电导联线

Models 监护仪型号	Connector 接头	Leads/label 导联数	Sino-K P/N 型号	OEM # 原装型号
43100A,43110A,43110M/MC, 43120A,43200A,77000AC, 77020A/AC/AR,77025A, 77030A,77035A,77040A, 78208A,78210A,78211A, 78330A,78331A,78332A, 78333A,78341A,78342A, 78345A,78346A,78351T, 78352A,78353A,78353B, 78354A,78532A,78532B, 78534A/B/C,78619A,78620A, 78660A/B,78661A/B,78670A, 78671A,M1722A/B,M1723A/B, M2400A,M2406A,M2745B, M3500B,M5500B	 SCN173	3/AHA	SG3123AA	M1580A
	 SCN116	3/IEC	SG3223AA	M1590A
	 SCN174	5/AHA	SG5123AA	M1600A
78352C,78354C,78834C, 862474 (C3),862475 (C3), 862478 (C3),862479 (C3), MP20,MP30,MP40,MP50, MP60,MP70,MP90,M1001A, M1001B,M1002A,M1002B, M1165A,M1166A,M1167A, M1175A,M1177A,M1205A, M1722A,M1722B,M2601A, M2745A,M3000A,M3001A, M3046A,M3500B,M3535A, M3536A,M4375A,M5500B	 SCN116	5/IEC	SG5223AA	M1610A
	 SCN173	3/AHA	SG3124AA	M1500A
	 SCN117	3/IEC	SG3224AA	M1510A

Philips-HP ECG CABLES&LEADWIRES 飞利浦心电导联线

Models 监护仪型号	Connector 接头	Leads/label 导联数	Sino-K P/N 型号	OEM # 原装型号
78352C,78354C,78834C, 862474 (C3),862475 (C3), 862478 (C3),862479 (C3), MP20,MP30,MP40,MP50, MP60,MP70,MP90,M1001A, M1001B,M1002A,M1002B, M1165A,M1166A,M1167A, M1175A,M1177A,M1205A, M1722A,M1722B,M2601A, M2745A,M3000A,M3001A, M3046A,M3500B,M3535A, M3536A,M4375A,M5500B	 SCN174	5/AHA	SG5124AA	M1520A
	 SCN117	5/IEC	SG5224AA	M1530A
78352C, 78354C, 78834C / 862472 to 862475 C3 Monitor / 862478, 862479 / 863064, 863065, 863066, 863068 SureSigns VM6, VM8 / M1001A/B, M1002A/B / M3000A, M3001A, M3002A MMS X2 M8102A MP2 Monitor, M8105A MP5 Monitor / M4735A, M3535A/M3536A	 SCN179	3/AHA 3/IEC	SG3224PH	M1669A
	 SCN117			
	 SCN180	5/AHA 5/IEC	SG5224PH	M1668A
 SCN117				
43100A,43110A,43110M/MC, 43120A,43200A,77000AC, 77020A/AC/AR,77025A, 77030A,77035A,77040A, 78208A,78210A,78211A, 78330A,78331A,78332A, 78333A,78341A,78342A, 78345A,78346A,78351T, 78352A,78353A,78353B, 78354A,78532A,78532B, 78534A/B/C,78619A,78620A, 78660A/B,78661A/B,78670A, 78671A,M1722A/B,M1723A/B, M2400A,M2406A,M2745B, M3500B,M5500B	 SCN175	3/AHA Leadwire-Pinch 夹式导联线	SG311AA	M1603A
		3/AHA Leadwire-Snap 扣式导联线	SG312AA	M1605A
		3/IEC Leadwire-Pinch 夹式导联线	SG321AA	M1613A
		3/IEC Leadwire-Snap 扣式导联线	SG322AA	M1615A
	 SCN176	5/AHA Leadwire-Pinch 夹式导联线	SG511AA	M1623A
		5/AHA Leadwire-Snap 扣式导联线	SG512AA	M1625A
		5/IEC Leadwire-Pinch 夹式导联线	SG521AA	M1633A
		5/IEC Leadwire-Snap 扣式导联线	SG522AA	M1635A

Philips-HP ECG CABLES&LEADWIRES 飞利浦心电导联线



Models 监护仪型号	Connector 接头	Leads/label 导联数	Sino-K P/N 型号	OEM # 原装型号
78352C, 78354C, 78834C / 862472 to 862475 C3 Monitor / 862478, 862479 / 863064, 863065, 863066, 863068 SureSigns VM6, VM8 / M1001A/B, M1002A/B / M3000A, M3001A, M3002A MMS X2 M8102A MP2 Monitor, M8105A MP5 Monitor / M4735A, M3535A/M3536A	 SCN181	3/AHA Leadwire-Pinch 夹式导联线	SG311PH	M1671A
		3/AHA Leadwire-Snap 扣式导联线	SG312PH	M1673A
		3/IEC Leadwire-Pinch 夹式导联线	SG321PH	M1672A
		3/IEC Leadwire-Snap 扣式导联线	SG322PH	M1674A
43100A,43110A,43110M/MC, 43120A,43200A,77000AC, 77020A/AC/AR,77025A, 77030A,77035A,77040A, 78208A,78210A,78211A, 78330A,78331A,78332A, 78333A,78341A,78342A, 78345A,78346A,78351T, 78352A,78353A,78353B, 78354A,78532A,78532B, 78534A/B/C,78619A,78620A, 78660A/B,78661A/B,78670A, 78671A,M1722A/B,M1723A/B, M2400A,M2406A,M2745B, M3500B,M5500B	 SCN182	5/AHA Leadwire-Pinch 夹式导联线	SG511PH	M1968A
		5/AHA Leadwire-Snap 扣式导联线	SG512PH	M1644A
		5/IEC Leadwire-Pinch 夹式导联线	SG521PH	M1971A
		5/IEC Leadwire-Snap 扣式导联线	SG522PH	M1645A
43100A,43110A,43110M/MC, 43120A,43200A,77000AC, 77020A/AC/AR,77025A, 77030A,77035A,77040A, 78208A,78210A,78211A, 78330A,78331A,78332A, 78333A,78341A,78342A, 78345A,78346A,78351T, 78352A,78353A,78353B, 78354A,78532A,78532B, 78534A/B/C,78619A,78620A, 78660A/B,78661A/B,78670A, 78671A,M1722A/B,M1723A/B, M2400A,M2406A,M2745B, M3500B,M5500B	 SCN116	3/AHA Fixed-Pinch 夹式一体化	SG3123P	
		3/AHA Fixed-Snap 扣式一体化	SG3123S	
		3/IEC Fixed-Pinch 夹式一体化	SG3223P	
		3/IEC Fixed-Snap 扣式一体化	SG3223S	
78352C,78354C,78834C, 862474 (C3),862475 (C3), 862478 (C3),862479 (C3), MP20,MP30,MP40,MP50, MP60,MP70,MP90,M1001A, M1001B,M1002A,M1002B, M1165A,M1166A,M1167A, M1175A,M1177A,M1205A, M1722A,M1722B,M2601A, M2745A,M3000A,M3001A, M3046A,M3500B,M3535A, M3536A,M4375A,M5500B	 SCN116	5/AHA Fixed-Pinch 夹式一体化	SG5123P	
		5/AHA Fixed-Snap 扣式一体化	SG5123S	
		5/IEC Fixed-Pinch 夹式一体化	SG5223P	
		5/IEC Fixed-Snap 扣式一体化	SG5223S	
78352C,78354C,78834C, 862474 (C3),862475 (C3), 862478 (C3),862479 (C3), MP20,MP30,MP40,MP50, MP60,MP70,MP90,M1001A, M1001B,M1002A,M1002B, M1165A,M1166A,M1167A, M1175A,M1177A,M1205A, M1722A,M1722B,M2601A, M2745A,M3000A,M3001A, M3046A,M3500B,M3535A, M3536A,M4375A,M5500B	 SCN117	3/AHA Fixed-Pinch 夹式一体化	SG3124P	
		3/AHA Fixed-Snap 扣式一体化	SG3124S	
		3/IEC Fixed-Pinch 夹式一体化	SG3224P	
		3/IEC Fixed-Snap 扣式一体化	SG3224S	



Philips-HP ECG CABLES&LEADWIRES 飞利浦心电导联线

Models 监护仪型号	Connector 接头	Leads/label 导联数	Sino-K P/N 型号	OEM # 原装型号
78352C,78354C,78834C, 862474 (C3),862475 (C3), 862478 (C3),862479 (C3), MP20,MP30,MP40,MP50, MP60,MP70,MP90,M1001A, M1001B,M1002A,M1002B, M1165A,M1166A,M1167A, M1175A,M1177A,M1205A, M1722A,M1722B,M2601A, M2745A,M3000A,M3001A, M3046A,M3500B,M3535A, M3536A,M4375A,M5500B	 SCN117	5/AHA Fixed-Pinch 夹式一体化	SG5124P	
		5/AHA Fixed-Snap 扣式一体化	SG5124S	
		5/IEC Fixed-Pinch 夹式一体化	SG5224P	
		5/IEC Fixed-Snap 扣式一体化	SG5224S	





Schiller/Brucker/ODM ECG CABLES&LEADWIRES 心电导联线

Models 监护仪型号	Connector 接头	Leads/label 导联数	Sino-K P/N 型号	OEM # 原装型号
	 SCN110	3/AHA Fixed-Pinch 夹式一体化	SG3125P	
		3/AHA Fixed-Snap 扣式一体化	SG3125S	
		3/IEC Fixed-Pinch 夹式一体化	SG3225P	
		3/IEC Fixed-Snap 扣式一体化	SG3225S	
	 SCN110	5/AHA Fixed-Pinch 夹式一体化	SG5125P	
		5/AHA Fixed-Snap 扣式一体化	SG5125S	
		5/IEC Fixed-Pinch 夹式一体化	SG5225P	
		5/IEC Fixed-Snap 扣式一体化	SG5225S	

Spacelabs ECG CABLES&LEADWIRES 太空心电导联线

Models 监护仪型号	Connector 接头	Leads/label 导联数	Sino-K P/N 型号	OEM # 原装型号
Ultraview New generation	 SCN177	5/AHA	SG5126SL	
	 SCN118	5/IEC	SG5226SL	

Spacelabs ECG CABLES&LEADWIRES 太空心电导联线

Models 监护仪型号	Connector 接头	Leads/label 导联数	Sino-K P/N 型号	OEM # 原装型号
Ultraview New generation	 SCN178	3/AHA Leadwire-Pinch 夹式导联线	SG311SL	
		3/AHA Leadwire-Snap 扣式导联线	SG312SL	
		3/IEC Leadwire-Pinch 夹式导联线	SG321SL	
		3/IEC Leadwire-Snap 扣式导联线	SG322SL	
	 SCN178	5/AHA Leadwire-Pinch 夹式导联线	SG511SL	
		5/AHA Leadwire-Snap 扣式导联线	SG512SL	
		5/IEC Leadwire-Pinch 夹式导联线	SG521SL	
		5/IEC Leadwire-Snap 扣式导联线	SG522SL	
	 SCN118	3/AHA Fixed-Pinch 夹式一体化	SG3126P	
		3/AHA Fixed-Snap 扣式一体化	SG3126S	
		3/IEC Fixed-Pinch 夹式一体化	SG3226P	
		3/IEC Fixed-Snap 扣式一体化	SG3226S	
 SCN118	5/AHA Fixed-Pinch 夹式一体化	SG5126P		
	5/AHA Fixed-Snap 扣式一体化	SG5126S		
	5/IEC Fixed-Pinch 夹式一体化	SG5226P		
	5/IEC Fixed-Snap 扣式一体化	SG5226S		

Biolight ECG CABLES&LEADWIRES 宝莱特心电导联线

Models 监护仪型号	Connector 接头	Leads/label 导联数	Sino-K P/N 型号	OEM # 原装型号
M7000	 SCN110	3/AHA Fixed-Pinch 夹式一体化	SG3135P	
		3/AHA Fixed-Snap 扣式一体化	SG3135S	
		3/IEC Fixed-Pinch 夹式一体化	SG3235P	
		3/IEC Fixed-Snap 扣式一体化	SG3235S	

**Biolight ECG CABLES&LEADWIRES 宝莱特心电导联线**

Models 监护仪型号	Connector 接头	Leads/label 导联数	Sino-K P/N 型号	OEM # 原装型号
M7000		5/AHA Fixed-Pinch 夹式一体化	SG5135P	
		5/AHA Fixed-Snap 扣式一体化	SG5135S	
		5/IEC Fixed-Pinch 夹式一体化	SG5235P	
		5/IEC Fixed-Snap 扣式一体化	SG5235S	
	SCN110			

**Creative ECG CABLES&LEADWIRES 科瑞康心电导联线**

Models 监护仪型号	Connector 接头	Options 探头类型	Sino-K P/N 型号	OEM # 原装型号
PC9000D		5/AHA Fixed-Pinch 夹式一体化	SG5127P	
		5/AHA Fixed-Snap 扣式一体化	SG5127S	
	SCP6-F5			

**Comen ECG CABLES&LEADWIRES 科曼心电导联线**

Models 监护仪型号	Connector 接头	Options 探头类型	Sino-K P/N 型号	OEM # 原装型号
		3/AHA Fixed-Pinch 夹式一体化	SG3132P	
		3/AHA Fixed-Snap 扣式一体化	SG3132S	
		3/IEC Fixed-Pinch 夹式一体化	SG3232P	
		3/IEC Fixed-Snap 扣式一体化	SG3232S	
	SCN101			

**M&B Straight ECG CABLES&LEADWIRES 麦邦心电导联线**

Models 监护仪型号	Connector 接头	Leads/label 导联数	Sino-K P/N 型号	OEM # 原装型号
CD2000		5/AHA Fixed-Pinch 夹式一体化	SG5128P	
		5/AHA Fixed-Snap 扣式一体化	SG5128S	
	SCN121			



**Holter Recorder ECG 动态心电(G)**

Models 监护仪型号	Connector 接头	Leads/label 导联数	Sino-K P/N 型号	OEM # 原装型号
Normal DIN 1.5		7 Leadwire-Snap 扣式导联线	SG712DN	
		10/AHA Leadwire-Snap 扣式导联线	SG112DN	
		10/IEC Leadwire-Snap 扣式导联线	SG122DN	
	SCN153			

**Holter Recorder ECG 动态心电(G)**

Models 监护仪型号	Connector 接头	Leads/label 导联数	Sino-K P/N 型号	OEM # 原装型号
Mortala 摩托拉		10/AHA Fixed-Snap 扣式一体化	SG1180S	
CENTURY TIMES 世纪金科		10/AHA Fixed-Snap 扣式一体化	SG1181S	
			SG1281S	
Landcom 蓝港		10/AHA Fixed-Snap 扣式一体化	SG1182S	
			SG1282S	
Mindray 迈瑞遥测		5/AHA Fixed-Snap 扣式一体化	SG5183S	
Philips 飞利浦动态 P.N 989803157491		5/AHA Fixed-Snap 扣式一体化	SG5188S	
		5/IEC Fixed-Snap 扣式一体化	SG5288S	
	SCN134			

**Disposable ECG/EKG electrodes 心电/心电图机电极片(BA)**

P/N 型号	Description 描述	Package 包装	MOQ 至少起订量	Photo 图片
SBA-101	Disposable adult foam electrode, Solid gel Diameter: 55mm 成人一次性电极片, 泡棉 直径: 55毫米	50pcs/bag 50个/包	1 pack 1包	
SBA-102	Disposable pediatric foam electrode, Solid gel Diameter: 43mm 儿童一次性电极片, 泡棉 直径: 43毫米	50pcs/bag 50个/包	1 bag 1包	
SBA-103	Disposable infant foam electrode, Solid gel Diameter: 30mm 婴儿一次性电极片, 泡棉 直径: 30毫米	100pcs/bag 100个/包	1 bag 1包	

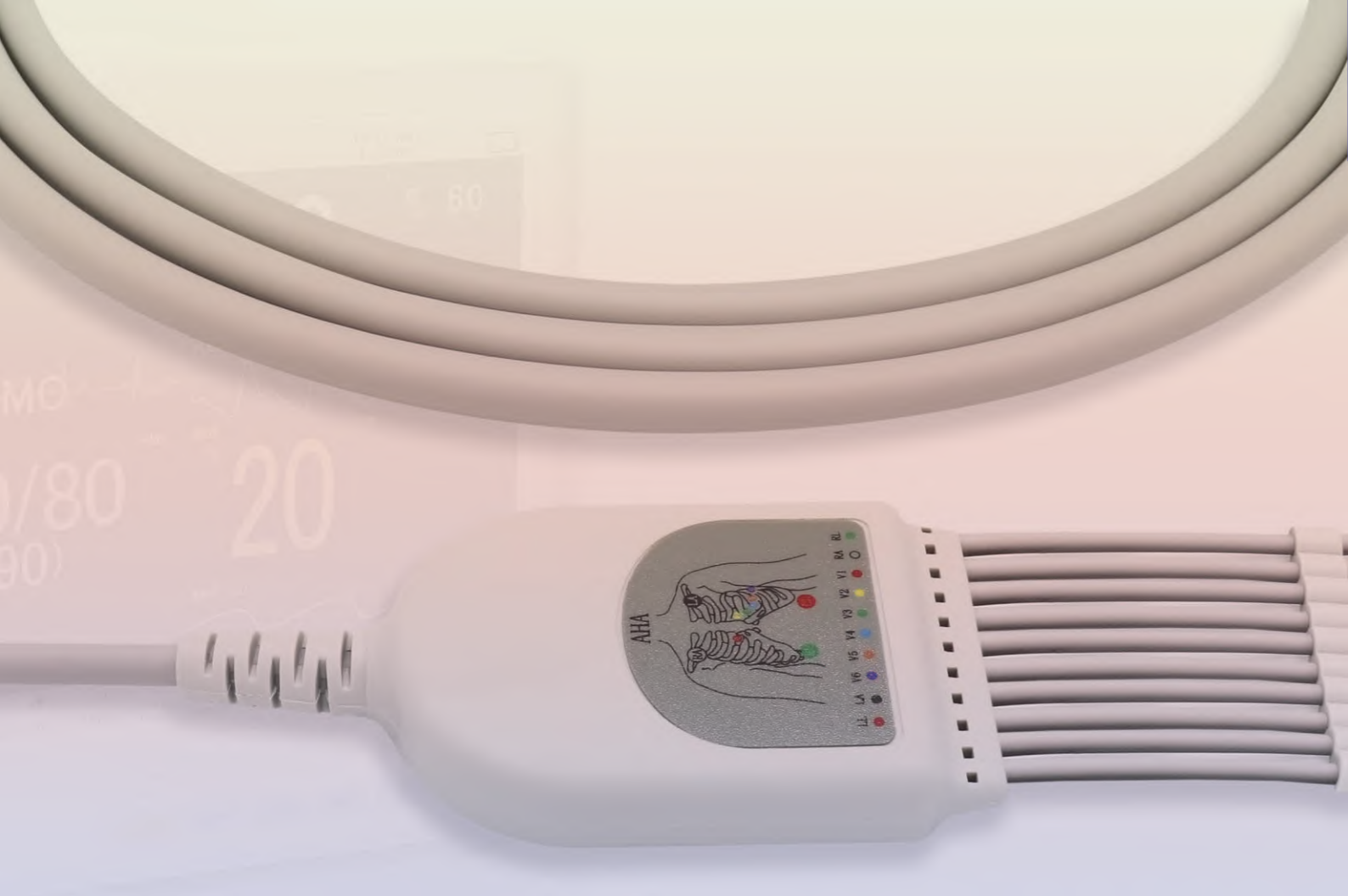

## EKG CABLES&ACCESSORIES心电图机导联线及配件

### Features and benefits

- ◆ Specially designed, fully shielded low noise medical TPU cable make show real signal  
全屏蔽低噪音定做TPU线材保证信号的真实性和不含乳胶的原材料
- ◆ Use of latex free and biocompatible components  
使用具有生物兼容性和不含乳胶的原材料
- ◆ Different connectors available for ECG cable compatible to most patient monitors  
兼容大多数监护仪品牌
- ◆ Comfortable Easy to clean and disinfect by immersing or wiping with many popular disinfectant solutions  
舒适 易于清洗和消毒



## EKG cables & accessories 心电图机导联线及心电图机配件

### Certification 产品认证



医疗器械产品备案编号：粤深械备20180153号  
医疗器械生产备案编号：粤深食药监械生产备20180045号

### Compliance with 符合标准

ANSI/AAMI EC53-1998(R)2001  
EN 60601-1:1990  
ISO10993-5-2009  
ISO10993-10-2009  
ISO 13485: 2016

Product types 产品类型	Photo 图片	P/N Example 型号示例	P/N Guide 型号识别
Fixed one-piece EKG cables 一体化心电图机导联线		SK 1 1 13 N	S: Sino-K K: EKG cables 1: 10 leads EKG cable 1: AHA (2: IEC) 13: Philips (01: Burdick) N: Needle (B: Banana)
Trunk cable 心电图机主电缆		SK 1 1 16 MQ	S: Sino-K K: EKG cables 1: 10 leads EKG cable 1: AHA (2: IEC) 06: GE-Marquette MQ: MQ type
Leadwire 心电图机导联线		SK 1 1 13 MQ	S: Sino-K K: EKG cables 1: 10 leads EKG cable 1: AHA (2: IEC) 3: Banana MQ: MQ type
Warranty: six-month warranty for EKG cables Package: 1pcs/bag 保修：6个月 包装：1个/包			

Burdick EKG CABLES 伯迪克心电图机导联线

Models 监护仪型号	Connector 接头	Leads/label 导联数	Options 探头类型	Sino-K P/N 型号	OEM # 原装型号
EK-10, Elite, Elite II, E-350, E350i, E550, E560, (1st Generation Eclipse LE/LEi, with serial number starting with 1051). Burdick #007705, Stress cable with detachable leads 007706	 SCN201	10/AHA	Fixed Banana 一体化香蕉头	SK1101B	012-0700-00
			Fixed Needle 一体化插针式	SK1101N	
			Fixed Snap 一体化扣式	SK1101S	
			Fixed Pinch 一体化钳式	SK1101P	
			Trunk cable 主电缆		
			Leadwiree Banana 导联线		
		10/IEC	Fixed Banana 一体化香蕉头	SK1201B	
			Fixed Needle 一体化插针式	SK1201N	
			Fixed Snap 一体化扣式	SK1201S	
			Fixed Pinch 一体化钳式	SK1201P	
			Trunk cable 主电缆		
			Leadwiree Banana 导联线		
ATRIA PLUS, ATRIA3000, Eclipse 4, Eclipse 400, Eclipse 8, Eclipse 800, Eclipse 850, Eclipse 850i, Eclipse Plus, Eclipse LE II BURDICK with serial number starting with 1067 or 92304	 SCN202	10/AHA	Fixed Banana 一体化香蕉头	SK1102B	012-0700-00
			Fixed Needle 一体化插针式	SK1102N	
			Fixed Snap 一体化扣式	SK1102S	
			Fixed Pinch 一体化钳式	SK1102P	
			Trunk cable 主电缆		
			Leadwiree Banana 导联线		
		10/IEC	Fixed Banana 一体化香蕉头	SK1202B	007704 012-0844-01
			Fixed Needle 一体化插针式	SK1202N	
			Fixed Snap 一体化扣式	SK1202S	
			Fixed Pinch 一体化钳式	SK1202P	
			Trunk cable 主电缆		
			Leadwiree Banana 导联线		

Fukuda Denshi EKG CABLES 福田心电图机导联线

Models 监护仪型号	Connector 接头	Leads/label 导联数	Options 探头类型	Sino-K P/N 型号	OEM # 原装型号
FX101 FX102F	 SCN203	10/AHA	Fixed Banana 一体化香蕉头	SK1103B	
			Fixed Needle 一体化插针式	SK1103N	
			Fixed Snap 一体化扣式	SK1103S	
			Fixed Pinch 一体化钳式	SK1103P	
			Trunk cable 主电缆		
			Leadwiree Banana 导联线		
		10/IEC	Fixed Banana 一体化香蕉头	SK1203B	
			Fixed Needle 一体化插针式	SK1203N	
			Fixed Snap 一体化扣式	SK1203S	
			Fixed Pinch 一体化钳式	SK1203P	
			Trunk cable 主电缆		
			Leadwiree Banana 导联线		

Fukuda Me EKG CABLES 心电图机导联线

Models 监护仪型号	Connector 接头	Leads/label 导联数	Options 探头类型	Sino-K P/N 型号	OEM # 原装型号
KP-500	 SCN204	10/AHA	Fixed Banana 一体化香蕉头	SK1104B	
			Fixed Needle 一体化插针式	SK1104N	
			Fixed Snap 一体化扣式	SK1104S	
			Fixed Pinch 一体化钳式	SK1104P	
			Trunk cable 主电缆		
			Leadwiree Banana 导联线		
		10/IEC	Fixed Banana 一体化香蕉头	SK1204B	
			Fixed Needle 一体化插针式	SK1204N	
			Fixed Snap 一体化扣式	SK1204S	
			Fixed Pinch 一体化钳式	SK1204P	
			Trunk cable 主电缆		
			Leadwiree Banana 导联线		

GE-Marquette EKG CABLES 马奎心电图机导联线

Models 监护仪型号	Connector 接头	Leads/label 导联数	Options 探头类型	Sino-K P/N 型号	OEM # 原装型号
MAC 500, MAC 1100, MAC 1200, MAC 1200ST	 SCN206	10/AHA	Fixed Banana 一体化香蕉头	SK1106B	2029893-001
			Fixed Needle 一体化插针式	SK1106N	
			Fixed Snap 一体化扣式	SK1106S	
			Fixed Pinch 一体化钳式	SK1106P	
			Trunk cable 主电缆	SK1106MQ	22341809
			Leadwiree Banana 导联线	SK113MQ	38401817
		10/IEC	Fixed Banana 一体化香蕉头	SK1206B	
			Fixed Needle 一体化插针式	SK1206N	
			Fixed Snap 一体化扣式	SK1206S	
			Fixed Pinch 一体化钳式	SK1206P	
			Trunk cable 主电缆	SK1206MQ	22341808
			Leadwiree Banana 导联线	SK123MQ	38401816

Kenz EKG CABLES 铃谦心电图机导联线

Models 监护仪型号	Connector 接头	Leads/label 导联数	Options 探头类型	Sino-K P/N 型号	OEM # 原装型号
(OEM P/N: PC-109)	 SCN208	10/AHA	Fixed Banana 一体化香蕉头	SK1108B	
			Fixed Needle 一体化插针式	SK1108N	
			Fixed Snap 一体化扣式	SK1108S	
			Fixed Pinch 一体化钳式	SK1108P	
			Trunk cable 主电缆		
			Leadwiree Banana 导联线		
		10/IEC	Fixed Banana 一体化香蕉头	SK1208B	
			Fixed Needle 一体化插针式	SK1208N	
			Fixed Snap 一体化扣式	SK1208S	
			Fixed Pinch 一体化钳式	SK1208P	
			Trunk cable 主电缆		
			Leadwiree Banana 导联线		

Kenz EKG CABLES 铃谦心电图机导联线

Models 监护仪型号	Connector 接头	Leads/label 导联数	Options 探头类型	Sino-K P/N 型号	OEM # 原装型号
16 male pins, Cardioline (OEM P/N: PC-104)	 SCN207	10/AHA	Fixed Banana 一体化香蕉头	SK1107B	
			Fixed Needle 一体化插针式	SK1107N	
			Fixed Snap 一体化扣式	SK1107S	
			Fixed Pinch 一体化钳式	SK1107P	
			Trunk cable 主电缆		
			Leadwiree Banana 导联线		
		10/IEC	Fixed Banana 一体化香蕉头	SK1207B	
			Fixed Needle 一体化插针式	SK1207N	
			Fixed Snap 一体化扣式	SK1207S	
			Fixed Pinch 一体化钳式	SK1207P	
			Trunk cable 主电缆		
			Leadwiree Banana 导联线		



Mortara EKG CABLES 摩托拉心电图机导联线

Models 监护仪型号	Connector 接头	Leads/label 导联数	Options 探头类型	Sino-K P/N 型号	OEM # 原装型号
	 SCN209	10/AHA	Fixed Banana 一体化香蕉头	SK1109B	
			Fixed Needle 一体化插针式	SK1109N	
			Fixed Snap 一体化扣式	SK1109S	
			Fixed Pinch 一体化钳式	SK1109P	
			Trunk cable 主电缆		
			Leadwiree Banana 导联线		
		10/IEC	Fixed Banana 一体化香蕉头	SK1209B	
			Fixed Needle 一体化插针式	SK1209N	
			Fixed Snap 一体化扣式	SK1209S	
			Fixed Pinch 一体化钳式	SK1209P	
			Trunk cable 主电缆		
			Leadwiree Banana 导联线		

Nihon Kohden 日本光电  
(Biocare, Dongjiang, Carewell, Comen, Osen, Spring, Zoncare, Contec) 邦健/东江/凯沃尔/科曼/奥升/施博瑞/中旗康泰  
EKG CABLES 心电图机导联线

Models 监护仪型号	Connector 接头	Leads/label 导联数	Options 探头类型	Sino-K P/N 型号	OEM # 原装型号	
ECG-1250, ECG-1350, ECG-9101, ECG-9130, ECG-9132, ECG-9620, PEA-1110 (No resistor)	 SCN210	10/AHA	Fixed Banana 一体化香蕉头	SK1110B		
			Fixed Needle 一体化插针式	SK1110N		
			Fixed Snap 一体化扣式	SK1110S		
			Fixed Pinch 一体化钳式	SK1110P		
			Trunk cable 主电缆			
			Leadwiree Banana 导联线			
	4.7k resistor	 SCN210	10/AHA	Fixed Banana 一体化香蕉头	SK1210B	BJ-902D
				Fixed Needle 一体化插针式	SK1210N	BA-901D
				Fixed Snap 一体化扣式	SK1210S	
				Fixed Pinch 一体化钳式	SK1210P	BJ-903D
				Trunk cable 主电缆		
				Leadwiree Banana 导联线		
4.7k resistor	 SCN210	10/AHA	Fixed Banana 一体化香蕉头	SK1111B		
			Fixed Needle 一体化插针式	SK1111N		
			Fixed Snap 一体化扣式	SK1111S		
			Fixed Pinch 一体化钳式	SK1111P		
			Trunk cable 主电缆			
			Leadwiree Banana 导联线			
	4.7k resistor	 SCN210	10/IEC	Fixed Banana 一体化香蕉头	SK1211B	
				Fixed Needle 一体化插针式	SK1211N	
				Fixed Snap 一体化扣式	SK1211S	
				Fixed Pinch 一体化钳式	SK1211P	
				Trunk cable 主电缆		
				Leadwiree Banana 导联线		

Philips/HP EKG CABLES 飞利浦心电图机导联线

Models 监护仪型号	Connector 接头	Leads/label 导联数	Options 探头类型	Sino-K P/N 型号	OEM # 原装型号	
M1770A, M1771A, M1772A, M2662A, Pagewrite100/200/200i	 SCN212	10/AHA	Fixed Banana 一体化香蕉头	SK1113B	M3702C	
			Fixed Needle 一体化插针式	SK1113N		
			Fixed Snap 一体化扣式	SK1113S		
			Fixed Pinch 一体化钳式	SK1113P		
			Trunk cable 主电缆			
			Leadwiree Banana 导联线			
	PageWriter Trim III	 SCN212	10/IEC	Fixed Banana 一体化香蕉头	SK1213B	M3703C
				Fixed Needle 一体化插针式	SK1213N	
				Fixed Snap 一体化扣式	SK1213S	
				Fixed Pinch 一体化钳式	SK1213P	
				Trunk cable 主电缆		
				Leadwiree Banana 导联线		
PageWriter Trim III	 SCN212	10/AHA	Fixed Banana 一体化香蕉头			
			Fixed Needle 一体化插针式			
			Fixed Snap 一体化扣式			
			Fixed Pinch 一体化钳式			
			Trunk cable 主电缆			
			Leadwiree Banana 导联线	SK114PH		
	PageWriter Trim III	 SCN212	10/IEC	Fixed Banana 一体化香蕉头		
				Fixed Needle 一体化插针式		
				Fixed Snap 一体化扣式		
				Fixed Pinch 一体化钳式		
				Trunk cable 主电缆		
				Leadwiree Banana 导联线	SK124PH	989803129191

Shanghai Nihon Kohden EKG CABLES 上海光电心电图机导联线

Models 监护仪型号	Connector 接头	Leads/label 导联数	Options 探头类型	Sino-K P/N 型号	OEM # 原装型号
	 SCN211	10/AHA	Fixed Banana 一体化香蕉头	SK1112B	
			Fixed Needle 一体化插针式	SK1112N	
			Fixed Snap 一体化扣式	SK1112S	
			Fixed Pinch 一体化钳式	SK1112P	
			Trunk cable 主电缆		
			Leadwiree Banana 导联线		
		10/IEC	Fixed Banana 一体化香蕉头	SK1212B	BD-615E
			Fixed Needle 一体化插针式	SK1212N	
			Fixed Snap 一体化扣式	SK1212S	
			Fixed Pinch 一体化钳式	SK1212P	
			Trunk cable 主电缆		
			Leadwiree Banana 导联线		

Siemens/Hellige EKG CABLES 心电图机导联线

Models 监护仪型号	Connector 接头	Leads/label 导联数	Options 探头类型	Sino-K P/N 型号	OEM # 原装型号
	 SCN215	10/AHA	Fixed Banana 一体化香蕉头	SK1115B	
			Fixed Needle 一体化插针式	SK1115N	
			Fixed Snap 一体化扣式	SK1115S	
			Fixed Pinch 一体化钳式	SK1115P	
			Trunk cable 主电缆		
			Leadwiree Banana 导联线		
		10/IEC	Fixed Banana 一体化香蕉头	SK1215B	
			Fixed Needle 一体化插针式	SK1215N	
			Fixed Snap 一体化扣式	SK1215S	
			Fixed Pinch 一体化钳式	SK1215P	
			Trunk cable 主电缆		
			Leadwiree Banana 导联线		

Schiller EKG CABLES 席勒心电图机导联线

Models 监护仪型号	Connector 接头	Leads/label 导联数	Options 探头类型	Sino-K P/N 型号	OEM # 原装型号
AT/1, AT/2, AT/3, AT/4, AT/5, AT/6, AT/10, AT/60, CS6, CS12, CS100-CS200, CV6, P80(short screw)	 SCN213	10/AHA	Fixed Banana 一体化香蕉头	SK1114B	
			Fixed Needle 一体化插针式	SK1114N	
			Fixed Snap 一体化扣式	SK1114S	
			Fixed Pinch 一体化钳式	SK1114P	
			Trunk cable 主电缆		
			Leadwiree Banana 导联线		
		10/IEC	Fixed Banana 一体化香蕉头	SK1214B	
			Fixed Needle 一体化插针式	SK1214N	
			Fixed Snap 一体化扣式	SK1214S	
			Fixed Pinch 一体化钳式	SK1214P	
			Trunk cable 主电缆		
			Leadwiree Banana 导联线		
Long screw	 SCN216	10/AHA	Fixed Banana 一体化香蕉头	SK1122B	
			Fixed Needle 一体化插针式	SK1122N	
			Fixed Snap 一体化扣式	SK1122S	
			Fixed Pinch 一体化钳式	SK1122P	
			Trunk cable 主电缆		
			Leadwiree Banana 导联线		
		10/IEC	Fixed Banana 一体化香蕉头	SK1222B	
			Fixed Needle 一体化插针式	SK1222N	
			Fixed Snap 一体化扣式	SK1222S	
			Fixed Pinch 一体化钳式	SK1222P	
			Trunk cable 主电缆		
			Leadwiree Banana 导联线		

## Multi-cable 多功能电缆(M)

Drager-Siemens Compatible MultiMed 5 Pod cable

德尔格-西门子多功能电缆

P/N: SM-SM-SGT5

Description: Drager-Siemens MultiMed 5 Pod cable,

2.5m, Compatible with SC6000, 7000, 8000,

9000, DRAGER Infinity, Delta and Delta XL

Parameter: Spo2, ECG(AHA&IEC), Temp

OEM P/N: 3368391 Or 5950196



### Limb Clamps 四肢夹

P/N 型号	Description 描述	Package 包装	Color 颜色	Photo 图片
SK9201	Adult limb clamps electrode with screw, Ag/AgCl, universal, 3mm/4mm, IEC GE OME: 2029894-001 成人多功能四肢夹, 镀氯化银, 欧标	4 pcs/pack 4个/盒	Red/black /green/yellow 红/黑/绿/黄	
SK9203	Adult limb clamps electrode, Nickel, 3mm/4mm, IEC 成人双功能四肢夹, 镀镍, 欧标	4 pcs/pack 4个/盒	Red/black /green/yellow 红/黑/绿/黄	
SK7201	Pediatric limb clamps electrode with screw, Ag/AgCl, universal, 3mm/4mm, IEC 儿童多功能四肢夹, 镀氯化银, 欧标	4 pcs/pack 4个/盒	Red/black /green/yellow 红/黑/绿/黄	

### Suction Electrode 胸吸球

P/N 型号	Description 描述	Package 包装	Color 颜色	Photo 图片
SK9202	Adult suction electrode with screw, Ag/AgCl, universal, 3mm/4mm Bulb diameter: 26mm GE OEM: 2029892-001 成人多功能胸吸球, 镀氯化银	6 pcs/pack 6个/盒	Blue 蓝色	
SK9204	Adult suction electrode, Nickel, 3mm/4mm Bulb diameter: 26mm GE OEM: 21714401 成人双功能胸吸球, 镀镍	6 pcs/pack 6个/盒	Blue 蓝色	
SK7202	Pediatric suction electrode with screw, Ag/AgCl, universal, 3mm/4mm Bulb diameter: 21mm 儿童多功能胸吸球, 镀氯化银	6 pcs/pack 6个/盒	Blue 蓝色	
SVV15	Multi-function ECG tab adapter 4.0多功能转换夹	10 pcs/pack 10个/盒	Purple 紫色	





## Reusable NIBP cuffs 重复性血压袖带

Selective Color  
可选颜色

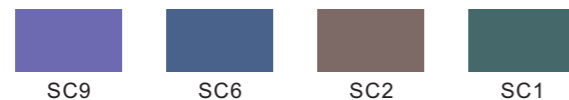

Certification  
产品认证



医疗器械产品备案编号：粤深械备20180154号

医疗器械生产备案编号：粤深食药监械生产备20180045号

医疗器械产品出口销售证明：SZQX20180024

Compliance with  
符合标准

ANSI/AAMI SP10-2002,  
EN 60601-1:1990  
ISO10993-5-2009  
ISO10993-10-2009  
EN980:2008  
EN1041:2008  
ISO 13485: 2016

## NIBP CUFFS, CONNECTORS AND ADAPTER HOSES 无创血压，接头及血压连接管

### Features and benefits

- ◆ Reusable and disposable cuffs are available with Single and double tube  
重复性，一次性，单双管袖带可用
- ◆ Easy to clean  
容易清洗
- ◆ Latex free  
不含乳胶



Product types 产品类型	Photo 图片	P/N Example 型号示例	P/N Guide 型号识别
NIBP disposable cuffs 一次性血压袖带		SC0105	S: Sino-K C: NIBP cuffs 0: Disposable cuff 1: single tube (2: two tubes) 05: cuff size
NIBP reusable cuffs with bag 重复性有囊血压袖带		SC1711	S: Sino-K C: NIBP cuffs 1: Reusable cuff nylon, 2 Reusable cuff PU brown, 6 Reusable cuff PU blue 7: Adult (6: Pediatric; 5: Infant; 3: Neonate; 8: Large Adult; 9: Thigh) 1: single tube (2: two tubes) 1: with bag
NIBP reusable cuffs without bag 重复性无囊血压袖带		SC1710	S: Sino-K C: NIBP cuffs 1: Reusable cuff brown PU 7: Adult (6: Pediatric; 5: Infant; 3: Neonate; 8: Large Adult; 9: Thigh) 1: single tube (2: two tubes) 0: without bag
NIBP adapter hoses 血压连接管		SH3907D	S: Sino-K H: NIBP adapter hoses 39:CB39 connector 07: CB07 connector D: Double tubes

Warranty: three-month warranty for NIBP cuffs; six-month warranty for NIBP Adapter Hoses;  
Package: 1pcs/bag  
保修：重复性袖带3个月；血压连接管6个月 包装：1个/包

Disposable NIBP Cuffs 一次性血压袖带

Size 尺寸	Single tube P/N 单管型号	Limb Circumference 臂周长	Double tube P/N 双管型号	Limb Circumference 臂周长	Package 包装
Neonate 新生儿	SC0101-44	3.3-5.6cm	SC0201-4444	3.3-5.6cm	1pcs/Bag
Neonate 新生儿	SC0102-44	4.2-7.1cm	SC0202-4444	4.2-7.1cm	1pcs/Bag
Neonate 新生儿	SC0103-44	5.0-10.5cm	SC0203-4444	5.0-10.5cm	1pcs/Bag
Neonate 新生儿	SC0104-44	6.9-11.7cm	SC0204-4444	6.9-11.7cm	1pcs/Bag
Neonate 新生儿	SC0105-44	8.9-15.0cm	SC0205-4444	8.9-15.0cm	1pcs/Bag
Neonate 新生儿	SC0106-44	7.7-10.5cm	SC0206-4444	7.7-10.5cm	1pcs/Bag
Infant 婴儿	SC0107-43/C0107-34/C0107-32	9.8-13.3cm	SC0207-3636/C0207-3232/C0207-3132	9.8-13.3cm	1pcs/Bag
Small Child 幼儿	SC0108-43/C0108-34/C0108-32	12.4-16.8cm	SC0208-3636/C0208-3232/C0208-3132	12.4-16.8cm	1pcs/Bag
Child 儿童	SC0109-43/C0109-34/C0109-32	15.8-21.3cm	SC0209-3636/C0209-3232/C0209-3132	15.8-21.3cm	1pcs/Bag
Small Adult 小成人	SC0110-43/C0110-34/C0110-32	20.0-27.0cm	SC0210-3636/C0210-3232/C0210-3132	20.0-27.0cm	1pcs/Bag
Adult 成人	SC0111-43/C0111-34/C0111-32	25.3-34.3cm	SC0211-3636/C0211-3232/C0211-3132	25.3-34.3cm	1pcs/Bag
Large Adult 大成人	SC0112-43/C0112-34/C0112-32	32.1-43.4cm	SC0212-3636/C0212-3232/C0212-3132	32.1-43.4cm	1pcs/Bag
Thigh 大腿	SC0113-43/C0113-34/C0113-32	46.0-66.0cm	SC0213-3636/C0213-3232/C0213-3132	46.0-66.0cm	1pcs/Bag

Please match right plastic NIBP Connectors for cuffs

Reusable NIBP Cuffs 重复血压袖带

Options 类型	Limb Circumference 臂周长	Single tube Blade 单管有囊	Double tube Blade 双管有囊	Photo 图片	Remarks 备注
Adult 成人	25.0-35.0cm	SC1711	SC1721		Please match right NIBP Connectors for cuffs 1pcs/Bag
Pediatric 儿童	18.0-26.0cm	SC1611	SC1621		
Infant 婴儿	10.0-19.0cm	SC1511	SC1521		
Neonate 新生儿	6.0-11.0cm	SC1311	SC1321		
Large Adult 大成人	33.0-47.0cm	SC1811	SC1821		
Thigh 大腿	46.0-66.0cm	SC1911	SC1921		

Reusable NIBP Cuffs 重复血压袖带

Options 类型	Limb Circumference 臂周长	Single tube Blade 单管有囊	Double tube Blade 双管有囊	Photo 图片	Remarks 备注
Adult 成人	25.0-35.0cm	SC6711	SC6721		Please match right NIBP Connectors for cuffs 1pcs/Bag
Pediatric 儿童	18.0-26.0cm	SC6611	SC6621		
Infant 婴儿	10.0-19.0cm	SC6511	SC6521		
Neonate 新生儿	6.0-11.0cm	SC6311	SC6321		
Large Adult 大成人	33.0-47.0cm	SC6811	SC6821		
Thigh 大腿	46.0-66.0cm	SC6911	SC6921		
Adult 成人	25.3-34.0cm	SC1710	SC1720		Please match right NIBP Connectors for cuffs 1pcs/Bag
Small Adult 小成人	20.0-27.0cm	SC1710S	SC1720S		
Child 儿童	15.8-21.3cm	SC1610	SC1620		
Infant 婴儿	9.8-13.3cm	SC1510	SC1520		
Neonate 新生儿	6.9-11.7cm	SC1310	SC1320		
Large Adult 大成人	32.1-43.4cm	SC1810	SC1820		
Thigh 大腿	46.0-66.0cm	SC1910	SC1920		

NIBP CUFFS 血压袖带

With connector 所带接头	Sino-K P/N 型号	Description (Blade) 描述 (有囊)	Sino-K P/N 型号	Description (Bladeless) 描述 (无囊)
	SC1711-43	Adult, Nylon, single tube, 25-35cm	SC1710-43	Adult, TPU&Nylon, single tube, 25.3-34.3cm
	SC1611-43	Pediatric, Nylon, single tube, 18-26cm	SC1610-43	Small adult, TPU&Nylon, single tube, 20-27cm
	SC1511-43	Infant, Nylon, single tube, 10-19cm	SC1510-43	Infant, TPU&Nylon, single tube, 12.4-16.8cm
			SC1410-43	Child, TPU&Nylon, single tube, 15.8-21.3cm
	SC1311-43	Neonate, Nylon, single tube, 6-11cm	SC1310-43	Neonate, TPU&Nylon, single tube, 6.9-11.7cm
	SC1811-43	Large Adult, Nylon, single tube, 33-47cm	SC1810-43	Large Adult, TPU&Nylon, single tube, 32.1-43.4cm
	SC1911-43	Thigh, Nylon, single tube, 46-66cm	SC1910-43	Thigh, TPU&Nylon, single tube, 46-66cm







NIBP CUFFS 血压袖带

With connector 所带接头	Sino-K P/N 型号	Description (Blade) 描述 (有囊)	Sino-K P/N 型号	Description (Bladeless) 描述 (无囊)
	SC1711-33	Adult, Nylon, single tube, 25-35cm	SC1710-33	Adult, TPU&Nylon, single tube, 25.3-34.3cm
	SC1611-33	Pediatric, Nylon, single tube, 18-26cm	SC1610-33	Small adult, TPU&Nylon, single tube, 20-27cm
	SC1511-33	Infant, Nylon, single tube, 10-19cm	SC1510-33	Infant, TPU&Nylon, single tube, 12.4-16.8cm
			SC1410-33	Child, TPU&Nylon, single tube, 15.8-21.3cm
	SC1311-33	Neonate, Nylon, single tube, 6-11cm	SC1310-33	Neonate, TPU&Nylon, single tube, 6.9-11.7cm
	SC1811-33	Large Adult, Nylon, single tube, 33-47cm	SC1810-33	Large Adult, TPU&Nylon, single tube, 32.1-43.4cm
	SC1911-33	Thigh, Nylon, single tube, 46-66cm	SC1910-33	Thigh, TPU&Nylon, single tube, 46-66cm
	SC1711-32	Adult, Nylon, single tube, 25-35cm	SC1710-32	Adult, TPU&Nylon, single tube, 25.3-34.3cm
	SC1611-32	Pediatric, Nylon, single tube, 18-26cm	SC1610-32	Small adult, TPU&Nylon, single tube, 20-27cm
	SC1511-32	Infant, Nylon, single tube, 10-19cm	SC1510-32	Infant, TPU&Nylon, single tube, 12.4-16.8cm
			SC1410-32	Child, TPU&Nylon, single tube, 15.8-21.3cm
	SC1311-32	Neonate, Nylon, single tube, 6-11cm	SC1310-32	Neonate, TPU&Nylon, single tube, 6.9-11.7cm
	SC1811-32	Large Adult, Nylon, single tube, 33-47cm	SC1810-32	Large Adult, TPU&Nylon, single tube, 32.1-43.4cm
	SC1911-32	Thigh, Nylon, single tube, 46-66cm	SC1910-32	Thigh, TPU&Nylon, single tube, 46-66cm
	SC1721-3636	Adult, Nylon, single tube, 25-35cm	SC1720-3636	Adult, TPU&Nylon, single tube, 25.3-34.3cm
	SC1621-3636	Pediatric, Nylon, single tube, 18-26cm	SC1620-3636	Small adult, TPU&Nylon, single tube, 20-27cm
	SC1521-3636	Infant, Nylon, single tube, 10-19cm	SC1520-3636	Infant, TPU&Nylon, single tube, 12.4-16.8cm
			SC1420-3636	Child, TPU&Nylon, single tube, 15.8-21.3cm
	SC1321-3636	Neonate, Nylon, single tube, 6-11cm	SC1320-3636	Neonate, TPU&Nylon, single tube, 6.9-11.7cm
	SC1821-3636	Large Adult, Nylon, single tube, 33-47cm	SC1820-3636	Large Adult, TPU&Nylon, single tube, 32.1-43.4cm
	SC1921-3636	Thigh, Nylon, single tube, 46-66cm	SC1920-3636	Thigh, TPU&Nylon, single tube, 46-66cm

NIBP CUFFS 血压袖带

With connector 所带接头	Sino-K P/N 型号	Description (Blade) 描述 (有囊)	Sino-K P/N 型号	Description (Bladeless) 描述 (无囊)
	SC1721-3232	Adult, Nylon, single tube, 25-35cm	SC1720-3232	Adult, TPU&Nylon, single tube, 25.3-34.3cm
	SC1621-3232	Pediatric, Nylon, single tube, 18-26cm	SC1620-3232	Small adult, TPU&Nylon, single tube, 20-27cm
	SC1521-3232	Infant, Nylon, single tube, 10-19cm	SC1520-3232	Infant, TPU&Nylon, single tube, 12.4-16.8cm
			SC1420-3232	Child, TPU&Nylon, single tube, 15.8-21.3cm
	SC1321-3232	Neonate, Nylon, single tube, 6-11cm	SC1320-3232	Neonate, TPU&Nylon, single tube, 6.9-11.7cm
	SC1821-3232	Large Adult, Nylon, single tube, 33-47cm	SC1820-3232	Large Adult, TPU&Nylon, single tube, 32.1-43.4cm
	SC1921-3232	Thigh, Nylon, single tube, 46-66cm	SC1920-3232	Thigh, TPU&Nylon, single tube, 46-66cm
	SC1721-3132	Adult, Nylon, single tube, 25-35cm	SC1720-3132	Adult, TPU&Nylon, single tube, 25.3-34.3cm
	SC1621-3132	Pediatric, Nylon, single tube, 18-26cm	SC1620-3132	Small adult, TPU&Nylon, single tube, 20-27cm
	SC1521-3132	Infant, Nylon, single tube, 10-19cm	SC1520-3132	Infant, TPU&Nylon, single tube, 12.4-16.8cm
			SC1420-3132	Child, TPU&Nylon, single tube, 15.8-21.3cm
	SC1321-3132	Neonate, Nylon, single tube, 6-11cm	SC1320-3132	Neonate, TPU&Nylon, single tube, 6.9-11.7cm
	SC1821-3132	Large Adult, Nylon, single tube, 33-47cm	SC1820-3132	Large Adult, TPU&Nylon, single tube, 32.1-43.4cm
	SC1921-3132	Thigh, Nylon, single tube, 46-66cm	SC1920-3132	Thigh, TPU&Nylon, single tube, 46-66cm

NIBP CONNECTORS 血压接头

P/N 型号	SCB01	SCB02	SCB03	SCB04	SCB05	SCB06	SCB07
Photo 图片							
Match 匹配	SCB01->SCB02	SCB02->SCB01	SCB03->SCB04	SCB04->SCB03	SCB05->SCB06	SCB06->SCB05	SCB07-> SCB36/SCB16
Use with 适用于	For Neonate air hose conn.	CAS, Drager, Kontron, Physio control, Schiller/ Bruker/Odam	Mennen (Old), Schiller/Bruker/ Odam, Spacelabs, Nihon Kohden Monitor plug	BCI, Datascope(Old)	Monitor plug	Colin, Gambro, Tyco (NPB 5500)	Critikon, Invivo, Kontron, Nihon Kohden GE:300619

**NIBP CONNECTORS 血压接头**

P/N 型号	SCB08	SCB09	SCB10	SCB11	SCB12	SCB13	SCB14
Photo 图片							
Match 匹配			SCB10->SCB11	SCB11->SCB10			
Use with 适用于	ID Barbed to ID Barbed, Metal	Philips/HP Monitor plug	Mindray, Schiller GE:330060	Philips, Siemens, Spacelabs, CSI, Welch Allyn, Datascope GE:330059 WA:5082-179	Drager Monitor plug	Monitor plug	PACE TECH Monitor plug
P/N 型号	SCB16	SCB30	SCB31	SCB32	SCB33	SCB34	SCB36
Photo 图片							
Match 匹配	SCB16->SCB07		SCB31->SCB32	SCB32->SCB31	SCB33->SCB34	SCB34->SCB33	SCB36->SCB07
Use with 适用于	Critikon, Invivo, Kontron, Mennen, Nihon Kohden, Welch Allyn GE:300664 WA:5082-164	ID Barbed to ID Barbed, Plastic GE:300670	Welch Allyn, Marquette, Datex-Ohmeda, Nihon Kohden GE: 330091 WA:5082-178	Welch Allyn Marquette, Datex, Zoll GE:330064 WA:5082-172	BCI, Datascope GE:300665 WA:5082-165	BCI, Datascope GE:300668 WA:5082-168	Critikon, Invivo, Kontron, Mennen, Nihon Kohden, Welch Allyn GE:300664 WA:5082-164
P/N 型号	SCB37	SCB38	SCB39	SCB40	SCB41	SCB42	SCB43
Photo 图片							
Match 匹配							SCB43->SCB10
Use with 适用于	GE AS/3, CS/3, S/5, Eagle4000, Cardiocap 5 Monitor plug	GE-Dinamap Monitor plug	GE-Dash, Eagle, Solar Monitor plug	Nihon Kohden For adult/pediatric Monitor plug	Nihon Kohden For neonate/infant Monitor plug	For neonate double tube disposable BP cuffs	Philips, Siemens, Spacelabs, CSI, Datascope WA:5082-184
P/N 型号	SCB44	SCB45	SCB46	SCB10-A	SCBS11	SCB08-A	SCB50
Photo 图片							
Match 匹配							
Use with 适用于	Neonate disposable cuff WA:5082-176	Use with all NIBP connector		(OEM)SAIRAN	(OEM)SAIRAN	(OEM)SAIRAN	

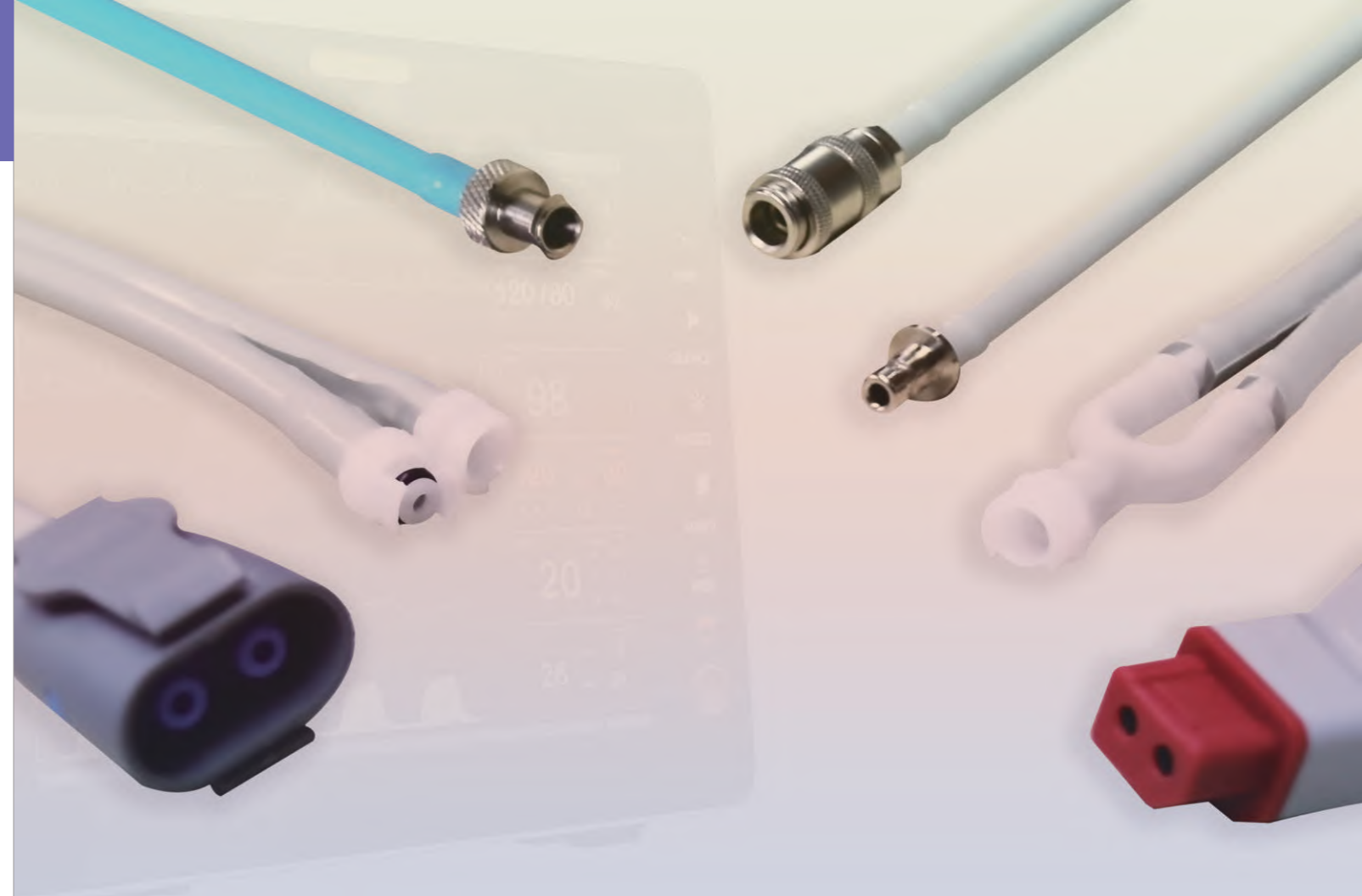

**NIBP adapter hoses**  
血压连接管

**Compliance with  
符合标准**

ISO 13485: 2016

ISO10993-5-2009

ISO10993-10-2009

Air shields NIBP ADAPTER HOSES 血压连接管

Models 监护仪型号	Tube 单双管	Monitor side Conn. 监护仪端接头	Cuff side Conn. 袖带端接头	Options 类型	Sino-K P/N 型号	OEM # 原装型号
Athena	2			P/N for Adult&Pedia. 成人/儿童型号	SH1107D	
				P/N for Infant&Neo. 婴儿/新生儿型号	SH1142ND	

Colin NIBP ADAPTER HOSES 科林血压连接管

Models 监护仪型号	Tube 单双管	Monitor side Conn. 监护仪端接头	Cuff side Conn. 袖带端接头	Options 类型	Sino-K P/N 型号	OEM # 原装型号
8800	1			P/N for Adult&Pedia. 成人/儿童型号	SH0506S	
				P/N for Infant&Neo. 婴儿/新生儿型号	SH0501NS	

CSI NIBP ADAPTER HOSES 血压连接管

Models 监护仪型号	Tube 单双管	Monitor side Conn. 监护仪端接头	Cuff side Conn. 袖带端接头	Options 类型	Sino-K P/N 型号	OEM # 原装型号
507,1100	2			P/N for Adult&Pedia. 成人/儿童型号	SH3707D	558
				P/N for Infant&Neo. 婴儿/新生儿型号	SH3742ND	
	1			P/N for Adult&Pedia. 成人/儿童型号	SH0510S	709
				P/N for Infant&Neo. 婴儿/新生儿型号	SH0501NS	
	1			P/N for Adult&Pedia. 成人/儿童型号	SH1010S	706
				P/N for Infant&Neo. 婴儿/新生儿型号	SH1001NS	

CSI NIBP ADAPTER HOSES 血压连接管

Models 监护仪型号	Tube 单双管	Monitor side Conn. 监护仪端接头	Cuff side Conn. 袖带端接头	Options 类型	Sino-K P/N 型号	OEM # 原装型号
507E,508, Scholar II (See Colin)	1			P/N for Adult&Pedia. 成人/儿童型号	SH0506S	
				P/N for Infant&Neo. 婴儿/新生儿型号	SH0501NS	

Dräger-Siemens NIBP ADAPTER HOSES 德尔格-西门子血压连接管

Models 监护仪型号	Tube 单双管	Monitor side Conn. 监护仪端接头	Cuff side Conn. 袖带端接头	Options 类型	Sino-K P/N 型号	OEM # 原装型号
SC6000-7000 /8000/9000Infinity	1			P/N for Adult&Pedia. 成人/儿童型号	SH1210S	1275275 EH50U
				P/N for Infant&Neo. 婴儿/新生儿型号	SH1201NS	2870298

GE-Critikon NIBP ADAPTER HOSES 强生血压连接管

Models 监护仪型号	Tube 单双管	Monitor side Conn. 监护仪端接头	Cuff side Conn. 袖带端接头	Options 类型	Sino-K P/N 型号	OEM # 原装型号
Dinamap 1846SX, Dinamap 8100, Dinamap 9300XL	2			P/N for Adult&Pedia. 成人/儿童型号	SH0707D	008841 E9050JY
				P/N for Infant&Neo. 婴儿/新生儿型号	SH0742ND	008840
(See CSI)	1			P/N for Adult&Pedia. 成人/儿童型号	SH3707D	9461-214
				P/N for Infant&Neo. 婴儿/新生儿型号	SH3742ND	

GE-Datex Ohmeda NIBP ADAPTER HOSES 德恩血压连接管

Models 监护仪型号	Tube 单双管	Monitor side Conn. 监护仪端接头	Cuff side Conn. 袖带端接头	Options 类型	Sino-K P/N 型号	OEM # 原装型号
AS/3,CS/3, Cardiicap 5, Cardiicap II, Light Monitor S/5	2			P/N for Infant&Neo. 婴儿/新生儿型号	SH3742ND	877514

GE-Datex Ohmeda NIBP ADAPTER HOSES 德恩血压连接管

Models 监护仪型号	Tube 单双管	Monitor side Conn. 监护仪端接头	Cuff side Conn. 袖带端接头	Options 类型	Sino-K P/N 型号	OEM # 原装型号
	2			P/N for Adult&Pedia. 成人/儿童型号	SH37312D	877235

GE-Critikon NIBP ADAPTER HOSES 强生血压连接管

Models 监护仪型号	Tube 单双管	Monitor side Conn. 监护仪端接头	Cuff side Conn. 袖带端接头	Options 类型	Sino-K P/N 型号	OEM # 原装型号
Eagle 4000, Tram 100/200 /250/300/350, Corometrics 120	2			P/N for Adult&Pedia. 成人/儿童型号	SH3907D	9461-203 E9001TE
				P/N for Infant&Neo. 婴儿/新生儿型号	SH3942ND	877514
Eagle 3000, DASH 2000/3000/4000, Tram 400/450/451, Tram 800/850/851, Corometrics 120	2			P/N for Adult&Pedia. 成人/儿童型号	SH3931D	414873-001 E9001TC 2017008-001
				P/N for Infant&Neo. 婴儿/新生儿型号	SH3942ND	414874-001 2017009-001
Dinamap MPS Series, Dinamap PRO 100/110/200 /210/300/310/400 Dinamap ProCare 100/120/200/220 /300/320/400	2			P/N for Adult&Pedia. 成人/儿童型号	SH3807D	107365
				P/N for Infant&Neo. 婴儿/新生儿型号	SH3842ND	107368

Invivo / MDE NIBP ADAPTER HOSES 英威血压连接管

Models 监护仪型号	Tube 单双管	Monitor side Conn. 监护仪端接头	Cuff side Conn. 袖带端接头	Options 类型	Sino-K P/N 型号	OEM # 原装型号
1400,5600 (See Nihon kohden)	2			P/N for Adult&Pedia. 成人/儿童型号	SH0707D	
				P/N for Infant&Neo. 婴儿/新生儿型号	SH0742ND	

Kontron (AVCO) NIBP ADAPTER HOSES 康强血压连接管

Models 监护仪型号	Tube 单双管	Monitor side Conn. 监护仪端接头	Cuff side Conn. 袖带端接头	Options 类型	Sino-K P/N 型号	OEM # 原装型号
Minimon 7137B, Minimon 7137Plus (See Critikon)	2			P/N for Adult&Pedia. 成人/儿童型号	SH0707D	
				P/N for Infant&Neo. 婴儿/新生儿型号	SH0742ND	

Medtronic-Physio Contro NIBP ADAPTER HOSES 美敦力血压连接管

Models 监护仪型号	Tube 单双管	Monitor side Conn. 监护仪端接头	Cuff side Conn. 袖带端接头	Options 类型	Sino-K P/N 型号	OEM # 原装型号
Lifepak 12	1			P/N for Adult&Pedia. 成人/儿童型号	SH1110S	
				P/N for Infant&Neo. 婴儿/新生儿型号	SH1101NS	

Mindray NIBP ADAPTER HOSES 迈瑞血压连接管

Models 监护仪型号	Tube 单双管	Monitor side Conn. 监护仪端接头	Cuff side Conn. 袖带端接头	Options 类型	Sino-K P/N 型号	OEM # 原装型号
PM-600, PM-6000, PM-7000, PM-8000, PM-8000 Express, PM-9000 Express, VS-800 (See CSI)	1			P/N for Adult&Pedia. 成人/儿童型号	SH1010S	M3918A
				P/N for Infant&Neo. 婴儿/新生儿型号	SH1001NS	
BeneView T5, BeneView T6, BeneView T8, MPM Module (See Philips)	1			P/N for Adult&Pedia. 成人/儿童型号	SH0910S	
				P/N for Infant&Neo. 婴儿/新生儿型号	SH0901NS	

Mindray-Datascope NIBP ADAPTER HOSES 血压连接管

Models 监护仪型号	Tube 单双管	Monitor side Conn. 监护仪端接头	Cuff side Conn. 袖带端接头	Options 类型	Sino-K P/N 型号	OEM # 原装型号
AccuTorr Plus,Duo, Passport 2, Passport 2LT, Spectrum,Spectrum OR Trio	1			P/N for Adult&Pedia. 成人/儿童型号	SH1010S	0683-04-0003 0683-04-0004

**Mindray-Datascope NIBP ADAPTER HOSES 血压连接管**

Models 监护仪型号	Tube 单双管	Monitor side Conn. 监护仪端接头	Cuff side Conn. 袖带端接头	Options 类型	Sino-K P/N 型号	OEM # 原装型号
AccuTorr Plus,Duo, Passport 2, Passport 2LT, Spectrum,Spectrum OR Trio	1			P/N for Infant&Neo. 婴儿/新生儿型号	SH1001NS	
3000,Accutorr 1, Accutorr 2, Accutorr 3, Accutorr 4, Accutorr Plus, ExpertPassport, Passport 2, Passport 2LT, Spectrum (See CSI)	1			P/N for Adult&Pedia. 成人/儿童型号	SH0510S	0683-04-0006
				P/N for Infant&Neo. 婴儿/新生儿型号	SH0510NS	
2100,2200I, Accutorr 1, Accutorr 2, Accutorr 3, Accutorr 4, Accutorr Plus, Passport 3L,Passport, Passport 2, Passport 2LT, Passport 5L, Spectrum	1			P/N for Adult&Pedia. 成人/儿童型号	SH0610S	0683-04-0007
				P/N for Infant&Neo. 婴儿/新生儿型号	SH0601NS	

**Nihon Kohden NIBP ADAPTER HOSES 光电血压连接管**

Models 监护仪型号	Tube 单双管	Monitor side Conn. 监护仪端接头	Cuff side Conn. 袖带端接头	Options 类型	Sino-K P/N 型号	OEM # 原装型号
AP-860PA Module, BSM-2101, BSM-2102, BSM-8301, BSM-8302, BSM-8500, BSM-8502, BSM-8800, Lifescope 14, Lifescope 9 Lifescope L	2			P/N for Adult&Pedia. 成人/儿童型号	SH0707D	6143-001321
				P/N for Infant&Neo. 婴儿/新生儿型号	SH0742ND	
AP-851PA Module, BSM-8300, BSM-8301, BSM-8302, Lifescope 9	1			P/N for Adult&Pedia. 成人/儿童型号	SH0304S	110088
				P/N for Infant&Neo. 婴儿/新生儿型号	SH0301NS	
CB40 is different from CB41	1			P/N for Adult&Pedia. 成人/儿童型号	SH4032D	YN-900P YN-901P
				P/N for Infant&Neo. 婴儿/新生儿型号	SH4101D	YN-920P YN-921P

**Nellcor NIBP ADAPTER HOSES 血压连接管**

Models 监护仪型号	Tube 单双管	Monitor side Conn. 监护仪端接头	Cuff side Conn. 袖带端接头	Options 类型	Sino-K P/N 型号	OEM # 原装型号
3100, 4000	1			P/N for Adult&Pedia. 成人/儿童型号	SH1010S	
				P/N for Infant&Neo. 婴儿/新生儿型号	SH1001NS	

**Philips/HP NIBP ADAPTER HOSES 飞利浦血压连接管**

Models 监护仪型号	Tube 单双管	Monitor side Conn. 监护仪端接头	Cuff side Conn. 袖带端接头	Options 类型	Sino-K P/N 型号	OEM # 原装型号
78352A, 78352C, 78354A, 78354C M1008A, M1008B, M3000	1			P/N for Adult&Pedia. 成人/儿童型号	SH0910S	M1599B M1598B
				P/N for Infant&Neo. 婴儿/新生儿型号	SH0901NS	M1597B M1596B
Compact A1 Compact A3	1			P/N for Adult&Pedia. 成人/儿童型号	SH1010S	M3918A
				P/N for Infant&Neo. 婴儿/新生儿型号	SH1001NS	

**Spacelabs Medical NIBP ADAPTER HOSES 太空血压连接管**

Models 监护仪型号	Tube 单双管	Monitor side Conn. 监护仪端接头	Cuff side Conn. 袖带端接头	Options 类型	Sino-K P/N 型号	OEM # 原装型号
Ultraview 90496 Ultraview 91496	1			P/N for Adult&Pedia. 成人/儿童型号	SH1010S	714-0018-00
				P/N for Infant&Neo. 婴儿/新生儿型号	SH1001NS	
Ultraview 90496 Ultraview 91496	1			P/N for Adult&Pedia. 成人/儿童型号	SH1134S	714-0019-01
				P/N for Infant&Neo. 婴儿/新生儿型号	SH1001NS	

# NIBP ADAPTER HOSES 血压连接管

## Spacelabs Medical NIBP ADAPTER HOSES 太空血压连接管

Models 监护仪型号	Tube 单双管	Monitor side Conn. 监护仪端接头	Cuff side Conn. 袖带端接头	Options 类型	Sino-K P/N 型号	OEM # 原装型号
All (dual tube) (See Nihon Kohden)	2			P/N for Adult&Pedia. 成人/儿童型号	SH0707D	
				P/N for Infant&Neo. 婴儿/新生儿型号	SH0742ND	
All (single luer) except PCI (See Datascope)	1			P/N for Adult&Pedia. 成人/儿童型号	SH0610S	
				P/N for Infant&Neo. 婴儿/新生儿型号	SH0601NS	

## Welch Allyn NIBP ADAPTER HOSES 伟伦血压连接管

Models 监护仪型号	Tube 单双管	Monitor side Conn. 监护仪端接头	Cuff side Conn. 袖带端接头	Options 类型	Sino-K P/N 型号	OEM # 原装型号
Atlas, Protocol (See Nihon Kohden)	1			P/N for Adult&Pedia. 成人/儿童型号	SH0304S	
				P/N for Infant&Neo. 婴儿/新生儿型号	SH0301NS	
Encore 202EL, Encore 204EL, Encore 206EL, Propaq 102EL, Propaq 104EL, Propaq 106EL, Protocol	1			P/N for Adult&Pedia. 成人/儿童型号	SH0731S	
				P/N for Infant&Neo. 婴儿/新生儿型号	SH0701NS	

## Zoll Medical NIBP ADAPTER HOSES 血压连接管

Models 监护仪型号	Tube 单双管	Monitor side Conn. 监护仪端接头	Cuff side Conn. 袖带端接头	Options 类型	Sino-K P/N 型号	OEM # 原装型号
Masim Series (See Datascope)	1			P/N for Adult&Pedia. 成人/儿童型号	SH0610S	
				P/N for Infant&Neo. 婴儿/新生儿型号	SH0601NS	



## IBP cables 有创压电缆

### Certification 产品认证



### Compliance with 符合标准

ANSI/AAMI EC53-1998(R)2001

EN 60601-1:1990

ISO10993-5-2009

ISO10993-10-2009

ISO 13485: 2016



## IBP ADAPTER CABLES 有创压电缆

### Features and benefits

- ◆ **Compatible with most of monitors**  
兼容大多数监护仪
- ◆ **Latex free**  
不含乳胶

B 03 01 :

B: IBP cable;



03: Edward (01: B.Bruan; 02: BD; 03: Medex/Abbott; 05: Utah 06:PVB)



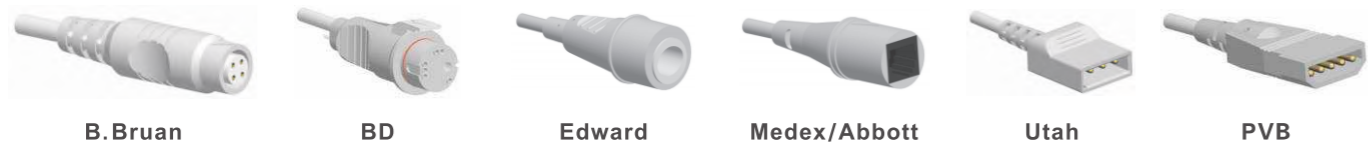

01: 6 pin general(02: Datascope; 03: Drager)





Warranty: six-month warranty for IBP adapter cables; 保修 : 6个月

Package: 1pcs/bag 包装 : 1个/包



Monitor manufacturers 监护仪厂家	Models 监护仪型号	Connector 接头	Options 探头类型	Sino-K P/N 型号
6P General 普通6针	BCI, IVY, Cititikon, Invivo, Mennen, Welch Allyn		B.Bruan 贝朗	SB0101
			BD	SB0201
			Edward 爱德华	SB0301
			Medex/Abbott 美戴/雅培	SB0401
			Utah 尤它	SB0501
			PVB	SB0601
Drager-Siemens 德尔格-西门子			B.Bruan 贝朗	SB0103
			BD	SB0203
			Edward 爱德华	SB0303
			Medex/Abbott 美戴/雅培	SB0403
			Utah 尤它	SB0503
			PVB	SB0603

Monitor manufacturers 监护仪厂家	Models 监护仪型号	Connector 接头	Options 探头类型	Sino-K P/N 型号
Drager-Siemens 德尔格-西门子	Sirecust 400-1281, SC8000		B.Bruan 贝朗	SB0104
			BD	SB0204
			Edward 爱德华	SB0304
			Medex/Abbott 美戴/雅培	SB0404
			Utah 尤它	SB0504
			PVB	SB0604
Drager-Siemens 德尔格-西门子	SC 6000,7000,9000		B.Bruan 贝朗	SB0105
			BD	SB0205
			Edward 爱德华	SB0305
			Medex/Abbott 美戴/雅培	SB0405
			Utah 尤它	SB0505
			PVB	SB0605
GE-Datex 德恩	NDE,PB, Nellcor, Tektronix, Viatek		B.Bruan 贝朗	SB0106
			BD	SB0206
			Edward 爱德华	SB0306
			Medex/Abbott 美戴/雅培	SB0406
			Utah 尤它	SB0506
			PVB	SB0606
GE-Marquette 马奎	Dash1000,2000,3000, 4000, Solar 8000,9000		B.Bruan 贝朗	SB0107
			BD	SB0207
			Edward 爱德华	SB0307
			Medex/Abbott 美戴/雅培	SB0407
			Utah 尤它	SB0507
			PVB	SB0607

Monitor manufacturers 监护仪厂家	Models 监护仪型号	Connector 接头	Options 探头类型	Sino-K P/N 型号
Kontron 康强	Minimon, Fetalmon Fetalogic Supermon	 SCN308	B.Bruan 贝朗	SB0108
			BD	SB0208
			Edward 爱德华	SB0308
			Medex/Abbott 美戴/雅培	SB0408
			Utah 尤它	SB0508
			PVB	SB0608
Mindray 迈瑞	BeneView T5 BeneView T6 BeneView T8 MPM	 SCN313	B.Bruan 贝朗	SB0112
			BD	SB0212
			Edward 爱德华	SB0312
			Medex/Abbott 美戴/雅培	SB0412
			Utah 尤它	SB0512
			PVB	SB0612
Mindray-Datascope	System80,82,83,84,90,90T, 95,98,97IABP,850,870,P2,P3, 2000,2000A,2001,2001A, 2002,2002A, Passport	 SCN302	B.Bruan 贝朗	SB0102
			BD	SB0202
			Edward 爱德华	SB0302
			Medex/Abbott 美戴/雅培	SB0402
			Utah 尤它	SB0502
			PVB	SB0602
Nihon Kohden 光电	Lifescope 6,9,12,14; AP-311P-800PA BMS 2100-8500A OEC 3200-8120A, OMP-3221E-n7203, Mercury 9510K	 SCN309	B.Bruan 贝朗	SB0109
			BD	SB0209
			Edward 爱德华	SB0309
			Medex/Abbott 美戴/雅培	SB0409
			Utah 尤它	SB0509
			PVB	SB0609

Monitor manufacturers 监护仪厂家	Models 监护仪型号	Connector 接头	Options 探头类型	Sino-K P/N 型号
Nihon Kohden 光电	BSM-2301	 SCN310	B.Bruan 贝朗	SB0110
			BD	SB0210
			Edward 爱德华	SB0310
			Medex/Abbott 美戴/雅培	SB0410
			Utah 尤它	SB0510
			PVB	SB0610
Philips/HP 飞利浦	78532A M1165A Merlin	 SCN311	B.Bruan 贝朗	SB0111
			BD	SB0211
			Edward 爱德华	SB0311
			Medex/Abbott 美戴/雅培	SB0411
			Utah 尤它	SB0511
			PVB	SB0611
Creative 科瑞康		 SCP4-R5	B.Bruan 贝朗	SB0113
			BD	SB0213
			Edward 爱德华	SB0313
			Medex/Abbott 美戴/雅培	SB0413
			Utah 尤它	SB0513
			PVB	SB0613

## DISPOSABLE IBP TRANSDUCER 一次性压力传感器

### Features and benefits

- ◆ Single patient use  
单个病人使用
- ◆ Easy to use with interface cables  
使用方便简单
- ◆ Abbott/Medex, Edward, Philips/B.Baun, B.D, Utah types available  
雅培/美戴, 爱德华, 布朗, B.D, 尤它可用
- ◆ Latex free  
不含乳胶



Sino-K P/N 型号	Photo 图片	Description 描述	Package 包装	MOQ 起订量
SBP-101		Abbott/Medex pressure transducer kits 雅培一次性压力传感器	1pcs/pack 1个/盒	10pcs 10个
SBP-102		Edward pressure transducer kits 爱德华一次性压力传感器	1pcs/pack 1个/盒	10pcs 10个
SBP-103		Philips/B.Baun pressure transducer kits 贝朗一次性压力传感器	1pcs/pack 1个/盒	10pcs 10个
SBP-104		B.D pressure transducer kits B.D一次性压力传感器	1pcs/pack 1个/盒	10pcs 10个
SBP-105		Utah pressure transducer kits 尤它一次性压力传感器	1pcs/pack 1个/盒	10pcs 10个



## Temperature probes 体温探头

### Certification 产品认证



### Compliance with 符合标准

BS EN12470-5:2001

EN 60601-1:1990

ISO10993-5-2009

ISO10993-10-2009

ISO 13485: 2016

## TEMPERATURE PROBES 重复性体温探头

### Features and benefits

- ◆ **Compatible with most of monitors**  
兼容大多数监护仪
- ◆ **Easy to use**  
使用简单
- ◆ **Latex free**  
不含乳胶  
T2307

T: Temperature probes

1: Skin type (2: General/Rectal type 3: Pediatric skin type 4: Pediatric general/rectal type)

3: 3.0m

07: YSI (01: Air shield; 02: Artema)

**Warranty: six-month warranty for IBP adapter cables; 保修：6个月**

**Package: 1pcs/bag 包装：1个/包**



Monitor manufacturers 监护仪厂家	Connector 接头	Options 探头类型	Sino-K P/N 型号	Len. 长度
Air Shield	 SCN401	Adult Skin 成人体表	ST1301	3.0m
		Adult General purpose 成人腔	ST2301	3.0m
		Pediatric Skin 儿童体表	ST3301	3.0m
		Pediatric General purpose 儿童腔	ST4301	3.0m
Artema-S&W 阿提玛	 SCN402	Adult Skin 成人体表	ST1302	3.0m
		Adult General purpose 成人腔	ST2302	3.0m
		Pediatric Skin 儿童体表	ST3302	3.0m
		Pediatric General purpose 儿童腔	ST4302	3.0m
Drager-Siemens 德尔格-西门子	 SCN403	Adult Skin 成人体表	ST1303	3.0m
		Adult General purpose 成人腔	ST2303	3.0m
		Pediatric Skin 儿童体表	ST3303	3.0m
		Pediatric General purpose 儿童腔	ST4303	3.0m

Monitor manufacturers 监护仪厂家	Connector 接头	Options 探头类型	Sino-K P/N 型号	Len. 长度
GE-Marquette 马奎	 SCN404	Adult Skin 成人体表	ST1304	3.0m
		Adult General purpose 成人腔	ST2304	3.0m
		Pediatric Skin 儿童体表	ST3304	3.0m
		Pediatric General purpose 儿童腔	ST4304	3.0m
Philips-HP 飞利浦	 SCN405	Adult Skin 成人体表	ST1305	3.0m
		Adult General purpose 成人腔	ST2305	3.0m
		Pediatric Skin 儿童体表	ST3305	3.0m
		Pediatric General purpose 儿童腔	ST4305	3.0m
Mindray 迈瑞	 SCN406	Adult Skin 成人体表	ST1306	3.0m
		Adult General purpose 成人腔	ST2306	3.0m
		Pediatric Skin 儿童体表	ST3306	3.0m
		Pediatric General purpose 儿童腔	ST4306	3.0m
YSI 400	 SCN407	Adult Skin 成人体表	ST1307	3.0m
		Adult General purpose 成人腔	ST2307	3.0m
		Pediatric Skin 儿童体表	ST3307	3.0m
		Pediatric General purpose 儿童腔	ST4307	3.0m
YSI 700	 SCN408	Adult Skin 成人体表	ST1308	3.0m
		Adult General purpose 成人腔	ST2308	3.0m
		Pediatric Skin 儿童体表	ST3308	3.0m
		Pediatric General purpose 儿童腔	ST4308	3.0m
10k YSI	 SCN407	Adult Skin 成人体表	ST1309	3.0m
		Adult General purpose 成人腔	ST2309	3.0m
		Pediatric Skin 儿童体表	ST3309	3.0m
		Pediatric General purpose 儿童腔	ST4309	3.0m

Monitor manufacturers 监护仪厂家	Connector 接头	Options 探头类型	Sino-K P/N 型号	Len. 长度
Creative 科瑞康	 SCP2-04G	Adult Skin 成人体表	ST1310	3.0m
		Adult General purpose 成人体腔	ST2310	3.0m
		Pediatric Skin 儿童体表	ST3310	3.0m
		Pediatric General purpose 儿童体腔	ST4310	3.0m
Spacelabs 太空	 SCN409	Adult Skin 成人体表	ST1311	3.0m
		Adult General purpose 成人体腔	ST2311	3.0m
		Pediatric Skin 儿童体表	ST3311	3.0m
		Pediatric General purpose 儿童体腔	ST4311	3.0m
Ohmeda 欧美达	 SCN410	Adult Skin 成人体表	ST1312	3.0m
		Adult General purpose 成人体腔	ST2312	3.0m
		Pediatric Skin 儿童体表	ST3312	3.0m
		Pediatric General purpose 儿童体腔	ST4312	3.0m



## Fetal probes 胎监探头

### Certification 产品认证



### Compliance with 符合标准

ISO 13485: 2016

ISO10993-5-2009

ISO10993-10-2009

## FETAL TRANSDUCER 胎监探头

### Features and benefits

- ◆ **Compatible perfectly with famous fetal monitor**  
完美兼容各种品牌的胎儿监护仪
- ◆ **Easy to insert and clear**  
使用简单,便于清洗
- ◆ **Latex free**  
不含乳胶
- Warranty: 12 months warranty for reusable temperature probes**  
保修: 12个月
- Package: 1pcs/bag 包装: 1个/包**



Monitor manufacturers 监护仪厂家	Connector 接头	Options 探头类型	Sino-K P/N 型号	OEM # 原装型号
Philips-HP 飞利浦 M1350 Series 50		TOCO 探头	SFM-012	M1355A
		US 探头	SFM-002	M1356A
GE Corometric 118 129 150 151 155		US 探头	SFM-013	5700HAX
OXFORD SONICAID TEAM 牛津		TOCO 探头	SFM-016	8400-6921
		US 探头	SFM-001	8400-6919

#### 1. 订货

电话订购:

请直拨0755-23341807

工作时间 周一至周五

上午9:00-12:00 下午1:30-6:00

传真订购:

请传真至0755-23204076

电子邮箱订购:

订单直接发送至INFO@SINO-K.COM

注意:

订购时, 须注明所订购的产品所适用机器型号、名称规格、数量贵公司的收货地址、联系人、电话信息。

常规产品订货总金额未达1000元需客户承担快递费。

当天下午5:00之后的订单顺应第二天处理, 交期可以与相关销售人员确认。

#### 2. 付款

转帐汇款: 您直接汇款至我们的开户行或者联系相关业务代表索取有效的银行帐户信息, 为了能使财务部能迅速确认已经到帐, 请在汇款时注明订购单号, 汇款时产生的手续费, 应由汇款方支付, 我们所收到的金额, 必须与订单金额一致。

如下帐户本公司的法定对公帐户:

银行: 中国工商银行股份有限公司深圳分行西乡支行

户名: 深圳市中仓医疗科技有限公司

账号: 4000 0234 1920 0860 514

以上帐户为本公司合法帐户, 书面发出的个人银行帐户信息需加盖本公司公章。任何人口头通知变更帐户信息无效, 否则由此造成的经济损失, 本公司不承担任何责任。

#### 3. 返修和退货

收到货三天内如果没有反馈型号错误或者缺失, 本公司默认验货通过, 本公司不承担相关责任

退返本公司的产品, 无论任何目的或原因, 必须有我司的型号或者序列号

按照客户要求定制产品, 不是质量原因不予退货

退货或者返修, 如不是本司原因, 往返运费由客户自行承担

过保产品维修费用, 具体咨询销售人员

目录中的产品有可能会停产, 升级或作部分设计改变不能作为退货理由, 如有疑问, 请订货前与相关销售人员进行确认

#### 4. 保修

一次性产品和接插件、原装产品、公司仅予以退换第一次使用时存在瑕疵或损坏的产品

可重复用血氧探头、血氧线、心电主电缆保修12个月(以送货单日期为准)

一体化心电导联线、心电导联线、有创压IBP电缆、体温探头保修6个月(以送货单日期为准)

可重复用血压袖带6个月(以送货单日期为准)

本公司对以上条款享有最终解释权

2019年7月

## Customer Service Guide

### 1 .How to order

Call:

Dial 0086-755-23341807

Business Time: Monday to Friday 9:00 AM -18:00 PM

Fax:

Fax your order to us: 0086-755-23204076 Business Time: Monday to Friday 9:00 AM -6:00 PM

Email:

Email your order to our sales or info@sino-k.com

Online Store:

[Https://www.sinokmed.com/](https://www.sinokmed.com/)

Notice:

Please inform us monitors models and name or Sino-K P.N, quantities when you place new orders

If you have any questions about the product, please contact with our sales departments

### 2 .Payment Methods

Wire Transfer

If you would like to remit payment directly to our bank, please transfer to the account exactly as Proforma invoice/Commercial Invoice .To expedite the payment process, please reference the Invoice number on the transfer documentation. Please send your remitted paper or Bank slip to our sales via email when you finished your payment .Following account is Valid

Bank Account(USD) Information

Beneficiary Bank Name: Industrial And Commercial BANK OF China, Shenzhen

Bank Account No.: 4000 0234 0920 0862 084

Beneficiary Bank Address: North Block, Financial Centre, Shennan Road East, Shenzhen, China

Swift Code: ICBKCNBJSZN

Beneficiary Add: 4/F,Bldg2,Veteran Ind.City,Gongle Community,Xixiang Street,Baoan District ,Shenzhen, China

HANG SENG Bank (USD):

Bank Name: HANG SENG BANK LIMITED

Address: 83 Des Voeux Road Central,Hong Kong

Account Name: HK SINO-K Technology Co.,Ltd

Account: 771-488467-883

SWIFT Code: HASEHKHH

For small value of payment, please send it via

Paypal:finance@sino-k.com

For more choices, please contact with our sales service

### 3. Warranty

Disposable product, Assembly parts and connectors do not have any warranty except it is defective when you first use

Original product refer to original manufacturer

Reusable Spo2 sensor &Cable, ECG trunk cable 12 months

EKG cable, ECG leadwires, IBP cable, temperature probe 6 months

Reusable NIBP cuff 6 months

Replace or Repair

The goods must have S.N/ P.N of Sino-K when you return our products no matter it is for repair or replace

Replacement

If our product quality problem or defectives for replacement, we bear the cost of transport freight, otherwise, clients bear all cost of return and delivery the goods

Repair

If our products return for repair during warranty date, clients bear all cost of return and delivery goods

**Notice:** The listed products might be modified or discontinued without advising in advance, if you want to confirm, please contact with our sales

### 4. Statements

The original brands or trademarks indicated in the catalogues are for the purpose of referring to the compatibility with Sino-K products. They are proprietarily owned by the respective manufacturer. Customers of Sino-K are advised to be aware of the patent issues Sino-K products might be involved with in the marketed areas, and are responsible for the relevant legal affairs.

Jul. 2019