

Aurora-3 Stage-Frame

DESK FRAME ONLY

NUR SCHREIBTISCHGESTELL

CADRE DE BUREAU UNIQUEMENT

SÓLO MARCO DE ESCRITORIO

SOLO TELAIO PER SCRIVANIA

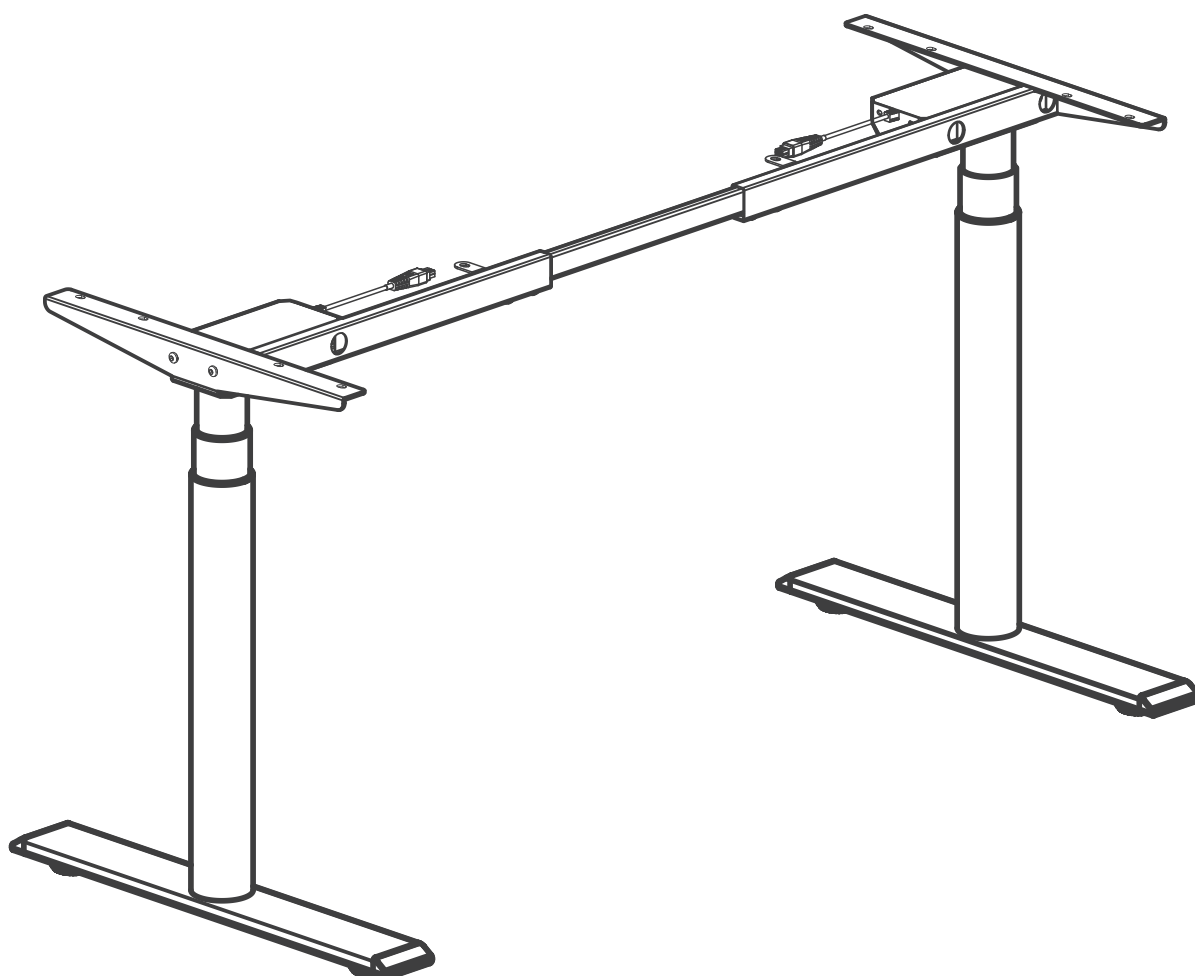

Assembly Instructions ▶

- Track Your Order
- Assembly Instruction
- Membership Registration
- Wholesale
- Contact Us
- About Us

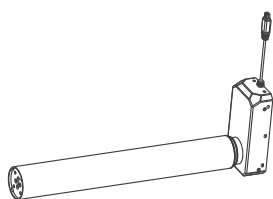

x2



x1

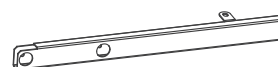

x1

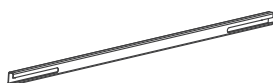

x1

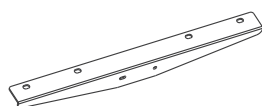

x2

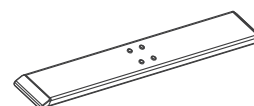

x2

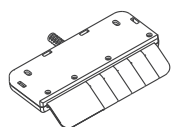

x1

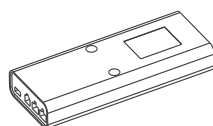

x1



x2



x1



x1



A-M6*10 x 12



B-ST5*14 x 16



C-ST4*16 x 2

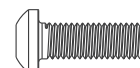

D-M6*35 x 8



x6



x1

1

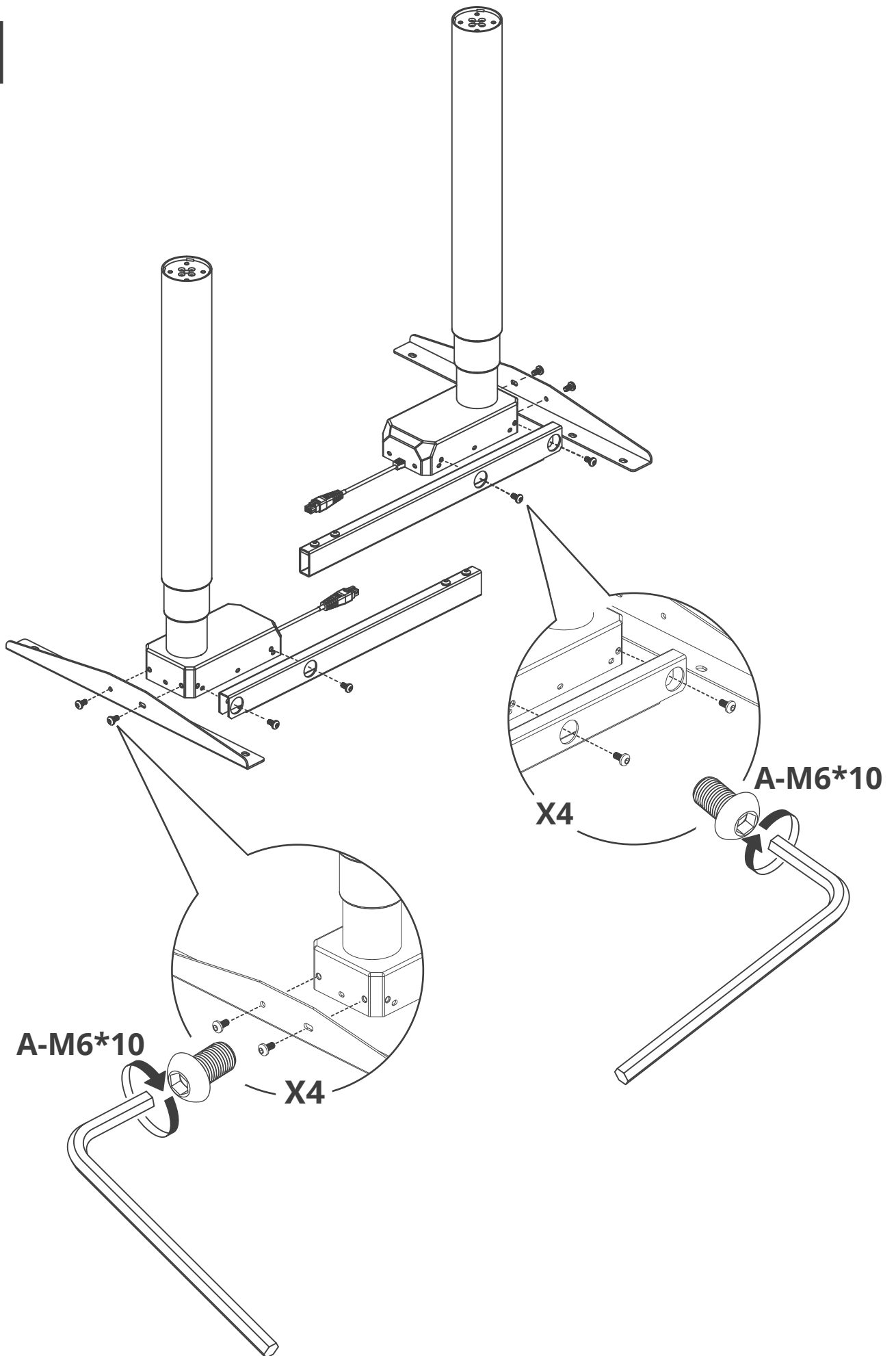

2

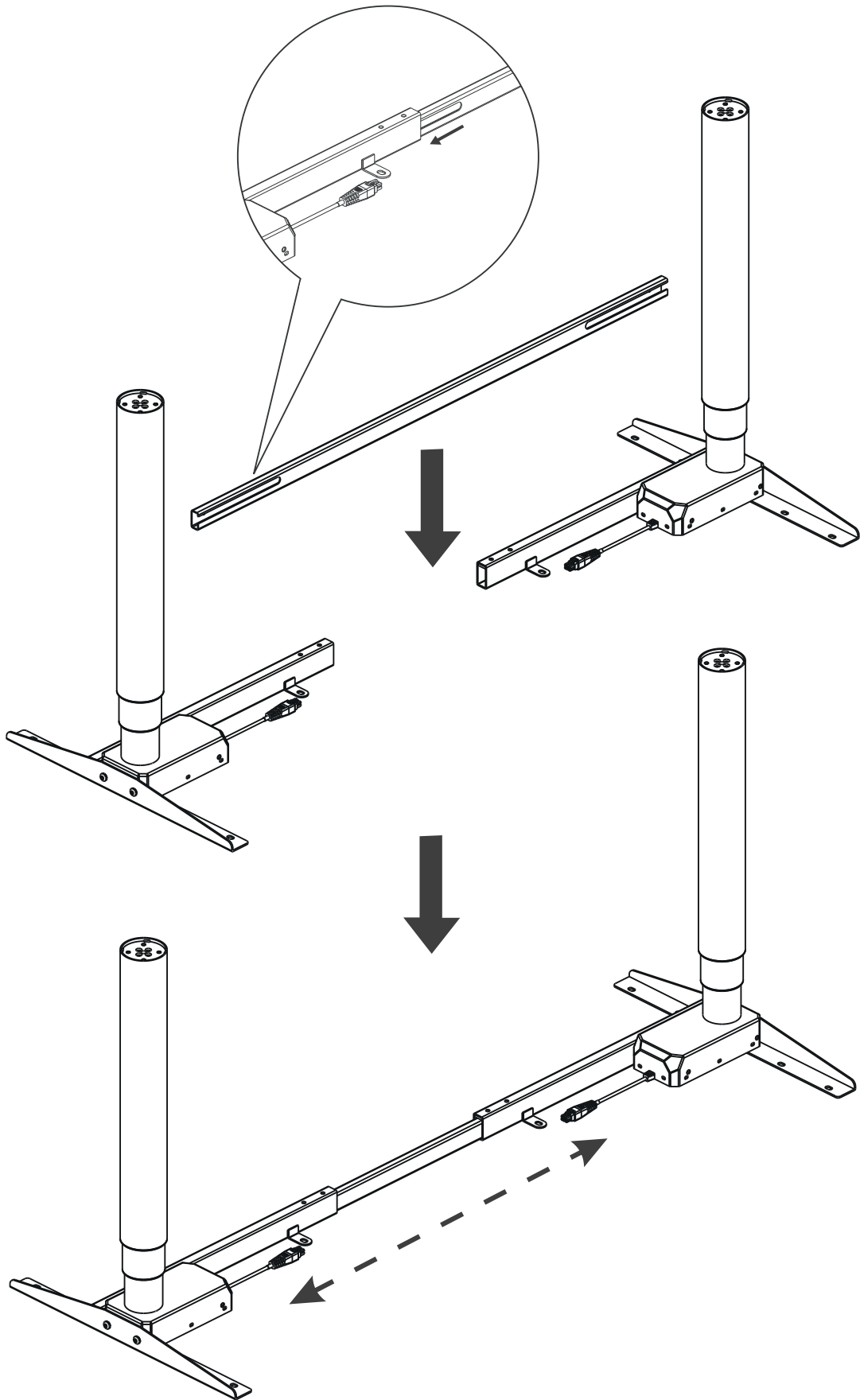



CONTINUE **ONLY**

AFTER COMPLETION OF DESKTOP ASSEMBLY

(*Please find Desktop Assembly Instructions in desktop package)



NUR **FORTSETZEN**

NACH ABSCHLUSS DER TISCHPLATTENMONTAGE

(*Bitte finden Sie die Anleitung zur Montage der Tischplatte im Tischplatte-Paket)



CONTINUER **UNIQUEMENT**

APRÈS L'ACHÈVEMENT DE L'ASSEMBLAGE DE PLATEAU

(*Veuillez trouver l'instruction d'assemblage de plateau dans le package de plateau)



CONTINUAR **SOLO**

DESPUÉS DE TERMINAR EL MONTAJE DEL ESCRITORIO

(*Busque las instrucciones de montaje del escritorio en el paquete de escritorio)



CONTINUA **SOLO**

DOPO IL COMPLETAMENTO DEL MONTAGGIO DELLA SCRIVANIA

(*Trova le istruzioni per il montaggio della scrivania nella confezione)

3

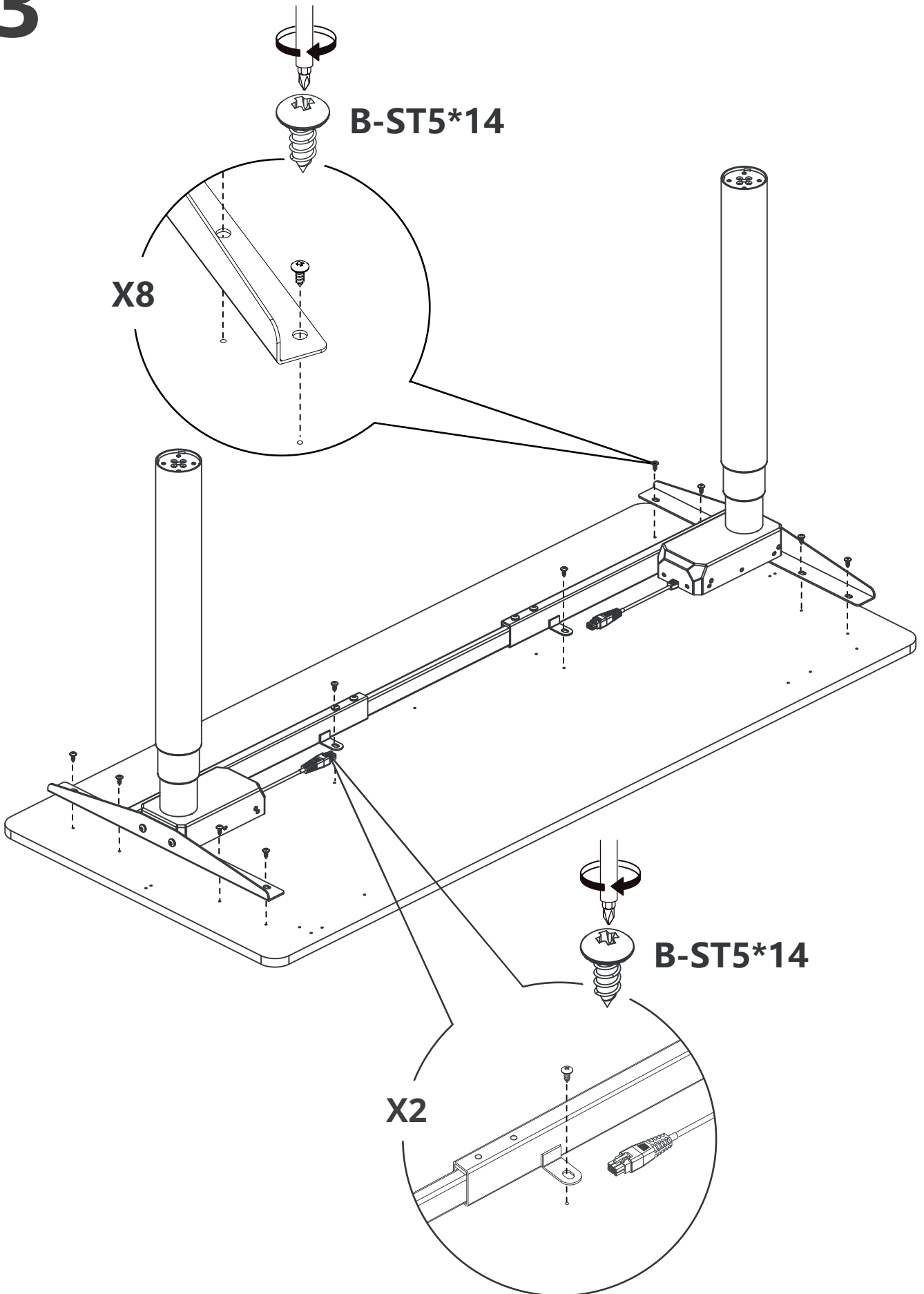

4

4

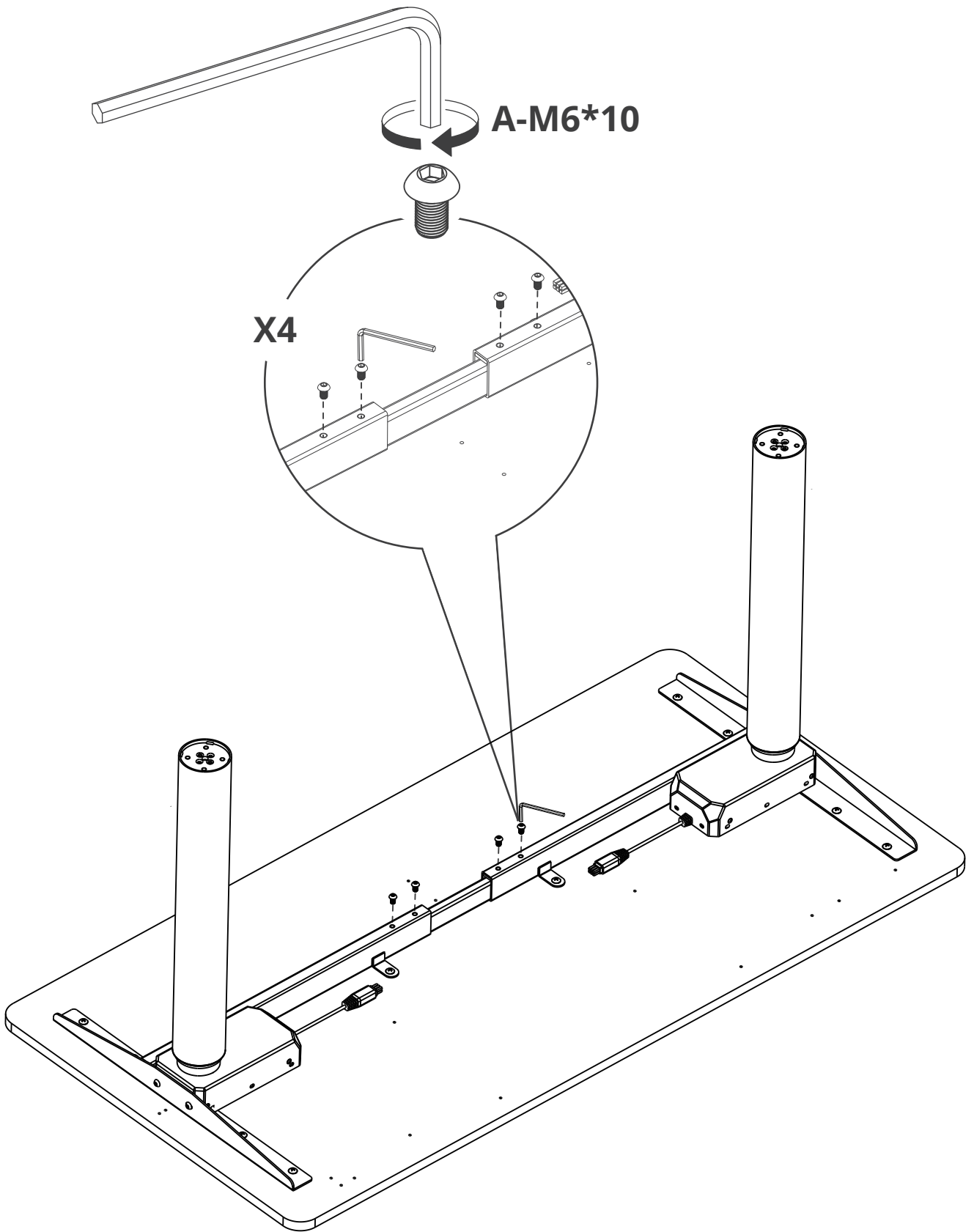

5

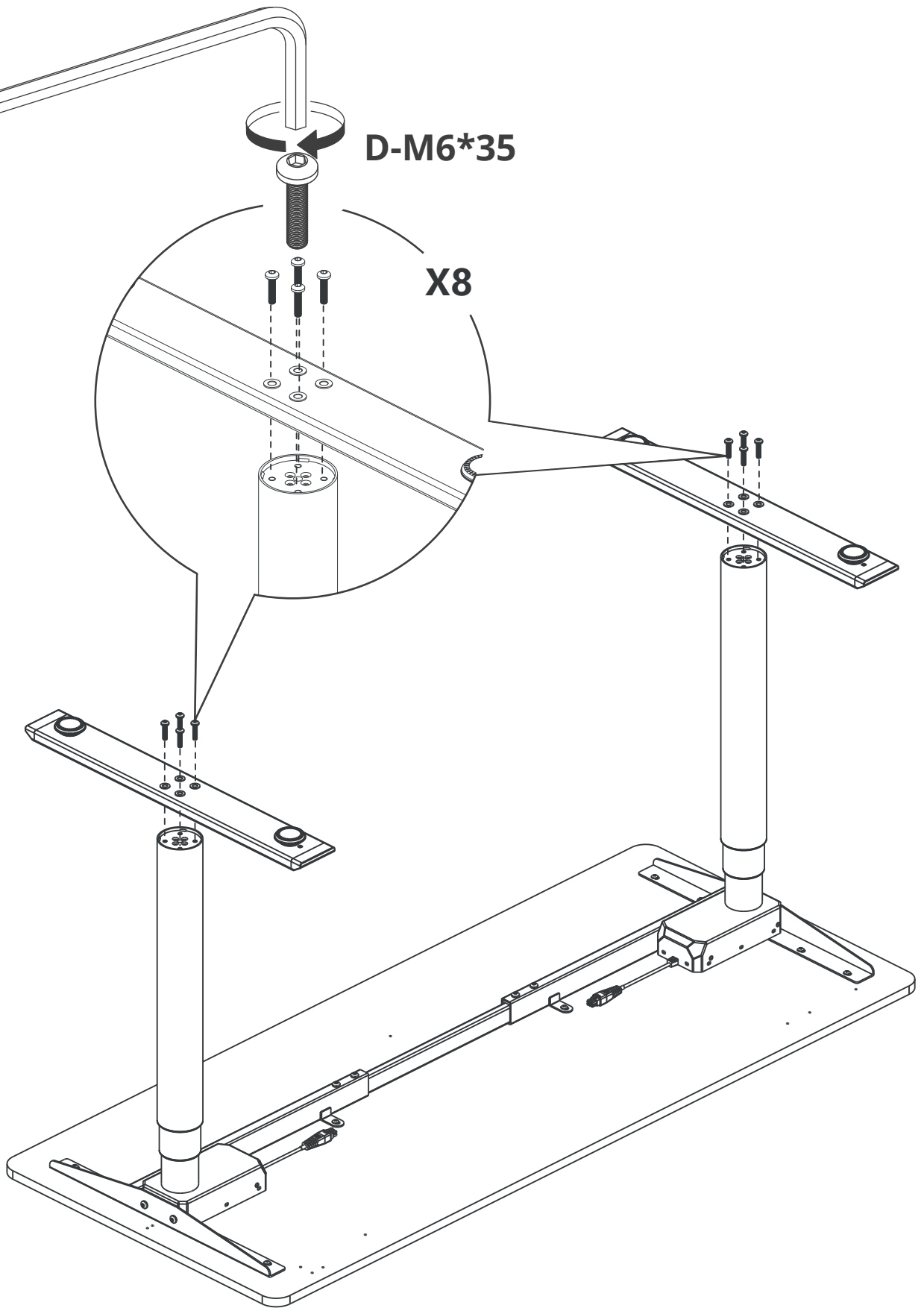

6

6

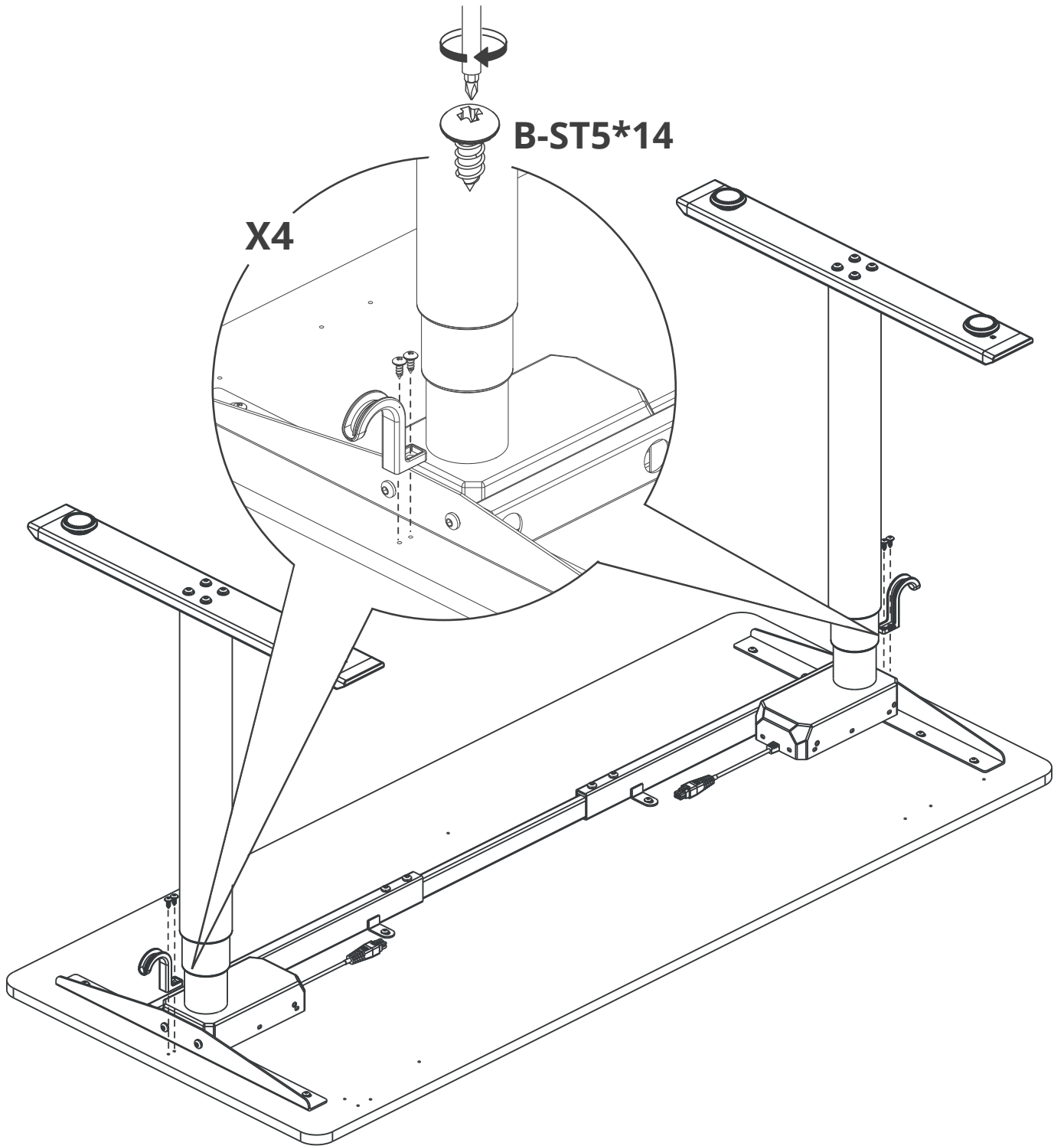

7

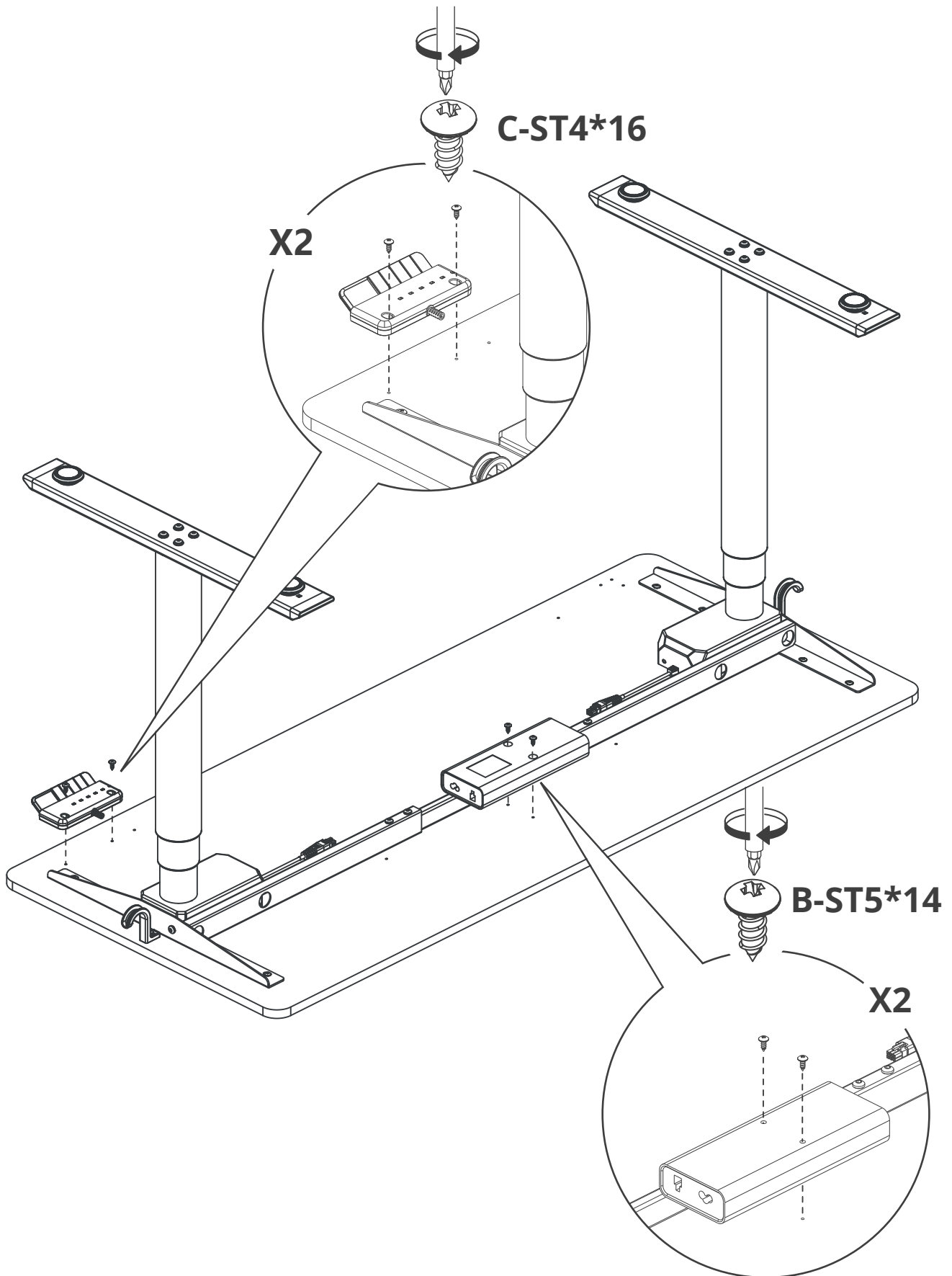

8

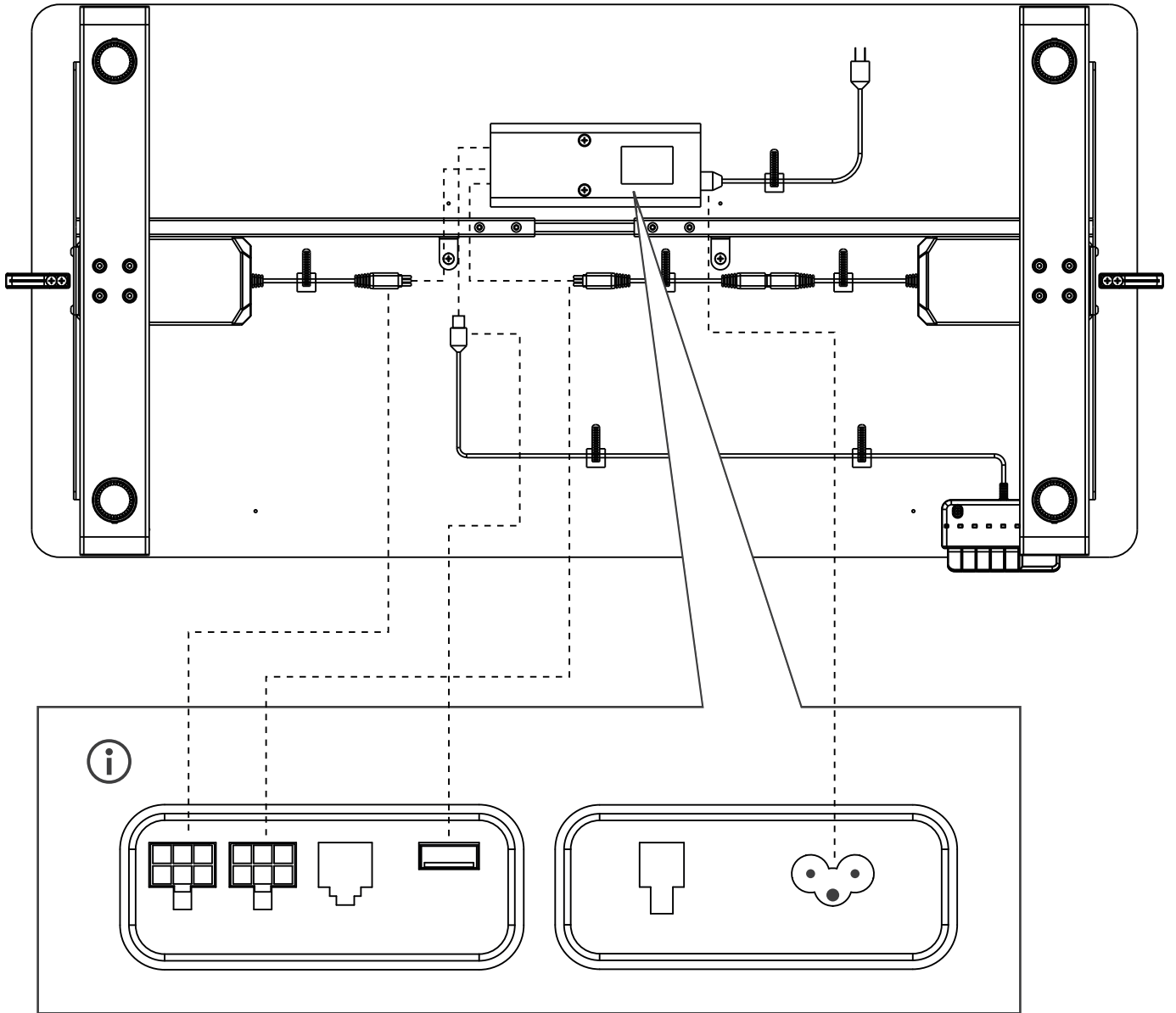

The actual lifting capacity varies by the desktops selected.

La capacité de levage réelle varie en fonction des plateaux sélectionnés.

Die tatsächliche Tragfähigkeit hängt von den ausgewählten Tischplatten ab.

La capacidad de elevación real varía según los escritorios seleccionados.

L'effettiva capacità di sollevamento varia a seconda della scrivania scelta.

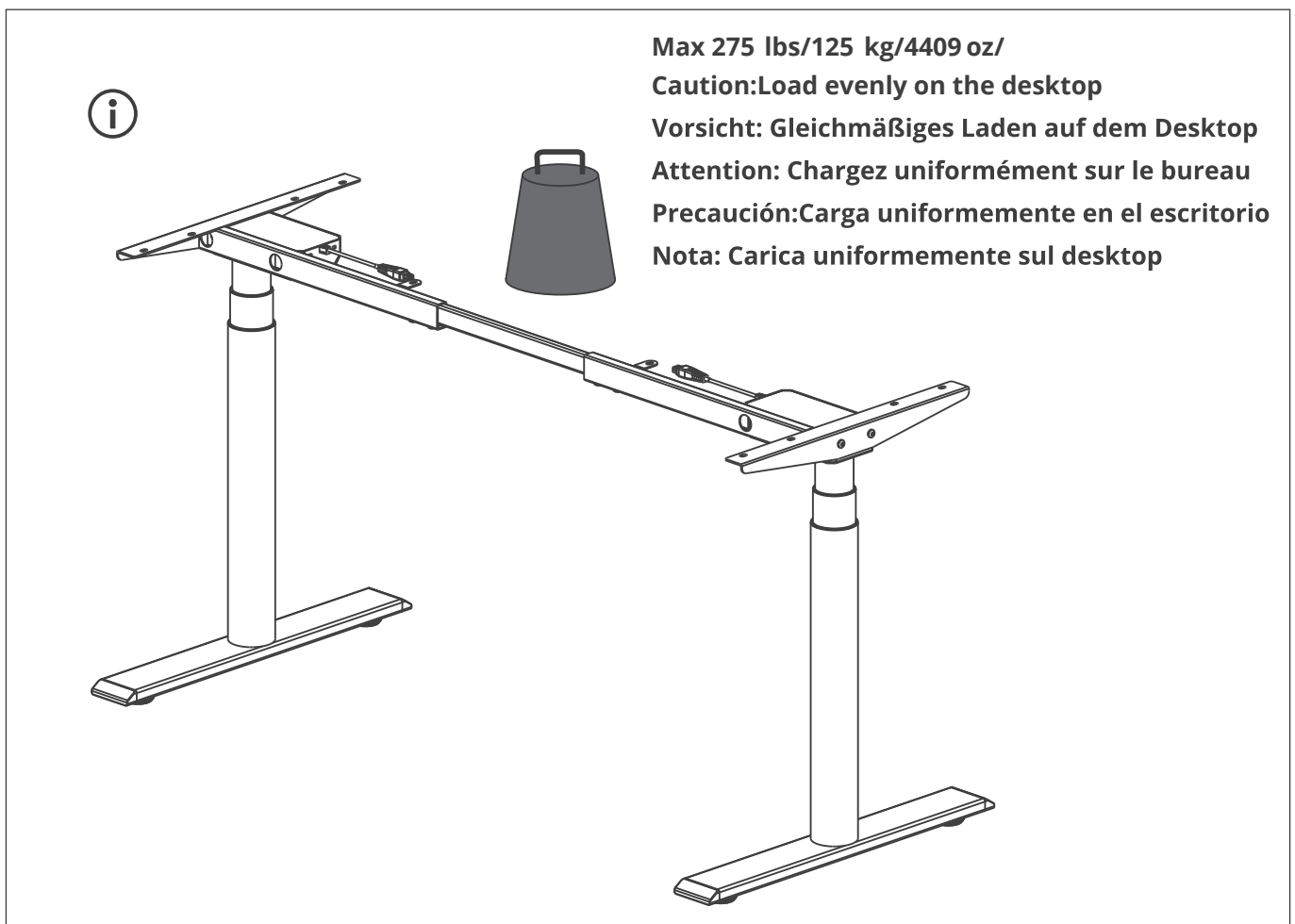

Operation Guide

Bedienerführung

Guide d'Opération

Manual de operaciones

Guida Operativa

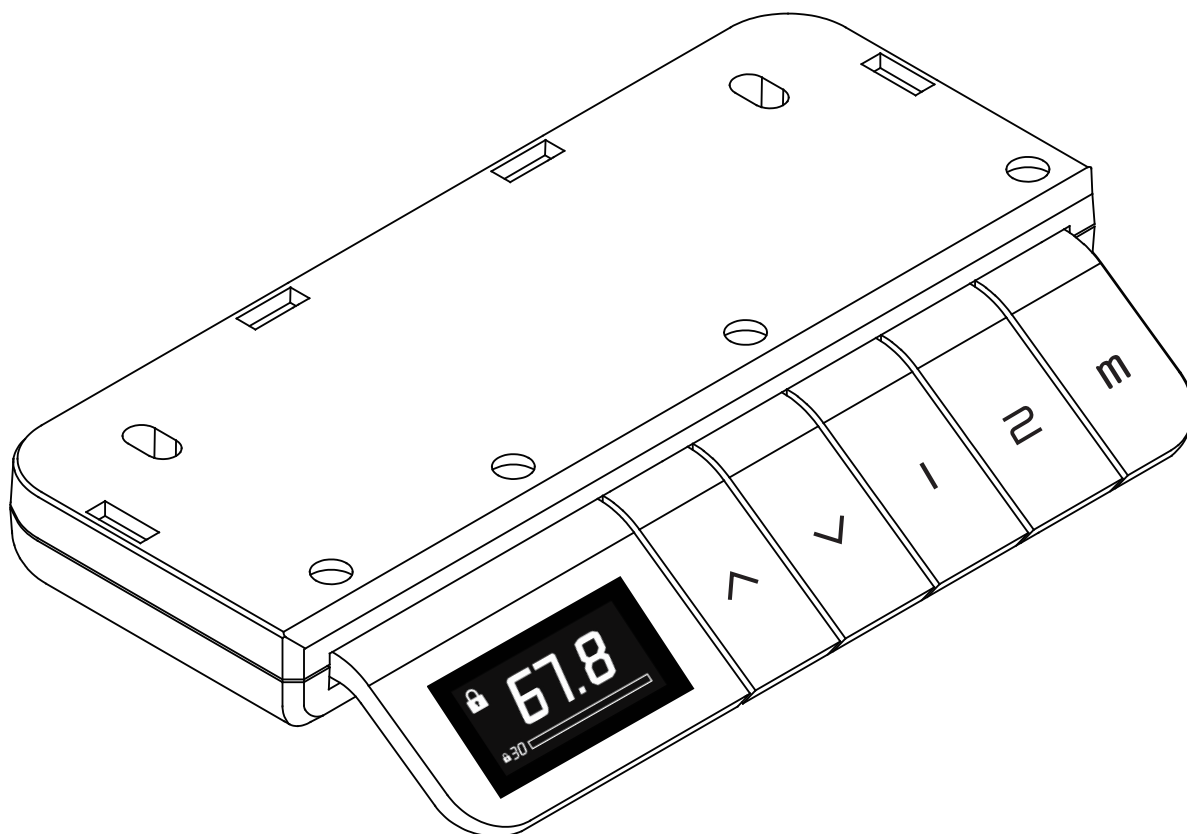

For Use with FEZiBO Desktops 48" and Larger

For assembly assistance, email service@fezibo.com

Handset Function Description

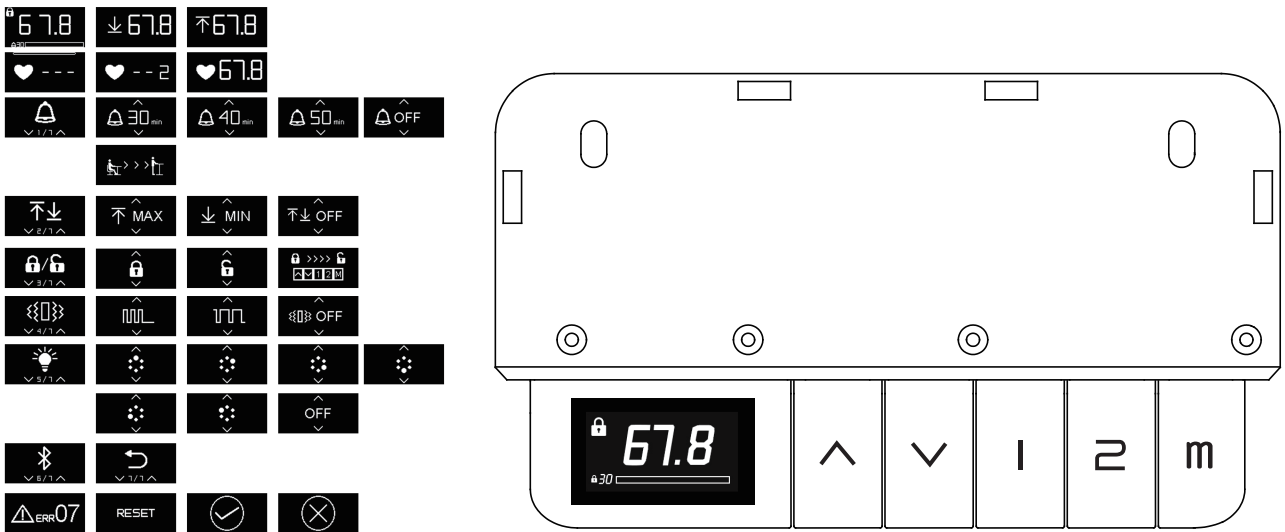

- Height display screen





1.The screen shows height number, a sedentary progress bar, and manual lock reminder **67.8** . When the handset is at the height of the display screen, it will enter the Logo display screen without operation for about 5 seconds, and then the screen will go out after 5 seconds . The logo will not be displayed and will not be extinguished when the handset opens the sedentary reminder, the handset lock and the unlock screen of the manual controller lock. When the standing desk reaches the upper and lower limit, there is an icon prompt **↑123** **↑67.8** .

- Function of the button





2.There are 5 buttons in total. The function of each button to display the screen at the height is: up, down, run to memory position 1, run to memory position 2, memory button. Press the M button and there is **♥---** . Release and then press 1 or 2 to record the current position as memory position 1 or 2 respectively **♥--2** **♥67.8** . Press the M button, and long press 2.5s to enter the main menu (progress bar to remind the progress). After entering, the interface of sedentary reminder will be displayed **🔔** . Press up and down button to realize page turning, and press M button to enter corresponding submenu. No operation for about 4 seconds or press M button in the return interface to return to the height display.

Handset Function Description

- **Sedentary Reminder**





3. Through the main menu's sedentary reminder screen . Press the M button to enter the sedentary reminder sub-menu and by turning the page to select the sedentary reminder time or cancel the sedentary reminder  . Press the return button or no operation for 4 seconds to return to the current submenu corresponding to the main menu. The confirm icon appears after confirming the sedentary reminder time  and return to the height display, and a sedentary reminder bar will appear at the bottom of the screen. The screen icon will be displayed when the time for sitting is up . And the handset will vibrate, the up button flashing red light prompt. Raise the standing desk to over 100cm and clear the time for sitting.





- **Handset lock function**



4. Open or close the handset lock   through the handset lock interface  of the main menu. After opening the handset lock, return to the height display through the icon . The small lock icon in the upper left corner of the height display indicates that the manual lock has been opened. No operation for 10 seconds after entering lock mode, the screen only shows the middle lock icon. Press any button and an unlock icon will appear . Unlocking according to the sequence of buttons shown can be returned to the height display. During the unlocking process, the light flashes to prompt the next button. The unlocking step remains unchanged when the next button is pressed for a long time without operation or error, and the diagram remains the same.



Handset Function Description

- Upper and lower limit function**

5. Enter the sub-menu through the upper and lower limit interface of the handset in the main menu . Through page turning to set the current position as the upper or lower limit, or to cancel the set of upper and lower limit at the same time  . It takes about 3s to set the upper and lower limit, and about 1s to cancel it. There is an icon prompt  .
- Vibration selection function**







6. Enter the sub-menu through the handset vibration selection interface of the main menu . There are two vibration options (for sedentary reminders), three short one long  and homogeneous vibration . There are corresponding vibration hints before selecting different vibration frequencies. Select turn off vibration from the submenu .
- Lighting adjustment function**

7. Enter the sub-menu through the handset light adjustment interface of the main menu . Select the lighting color by turning the page, as shown . There are 6 colors in total. See attached table for details. When selecting in the menu, the corresponding color of M button will be lit up for prompt. After setting, the height display will be returned. The light is the default blue color at each turn on, leaving the previous color unchanged.
- Abnormal indication**

8. If the controller has an exception, the following prompt will appear . When normal working time drops to the bottom or abnormal time appears, press the down button 5s and enter the reset state, and the following prompt will appear . Red light flashing when abnormal error and reset state. Reset by pressing down button. After the reset, it will turn off the opened sedentary reminder and handset lock.

Attached list

Lighting adjustment color

Icon	Color
	Blue
	Cyan
	Indian red
	Violet
	Dark orange
	White
	/

Why choose FEZiBO?

Many ergonomic office solutions come at a high cost. Our mission is to bring you a more affordable solution with innovation, creativity, and efficiency without compromising quality or ease of use.



WARRANTY SERVICES

To provide you with the best service, don't forget to register your FEZiBO product to confirm your warranty.

It only takes a few simple steps and then you can access a wide range of services such as technical support, new product alerts, promotions, and warranty services from FEZiBO.

Send your name and order ID to service@fezibo.com

For more FEZiBO products, check out our website at: www.fezibo.com

Bedienerführung

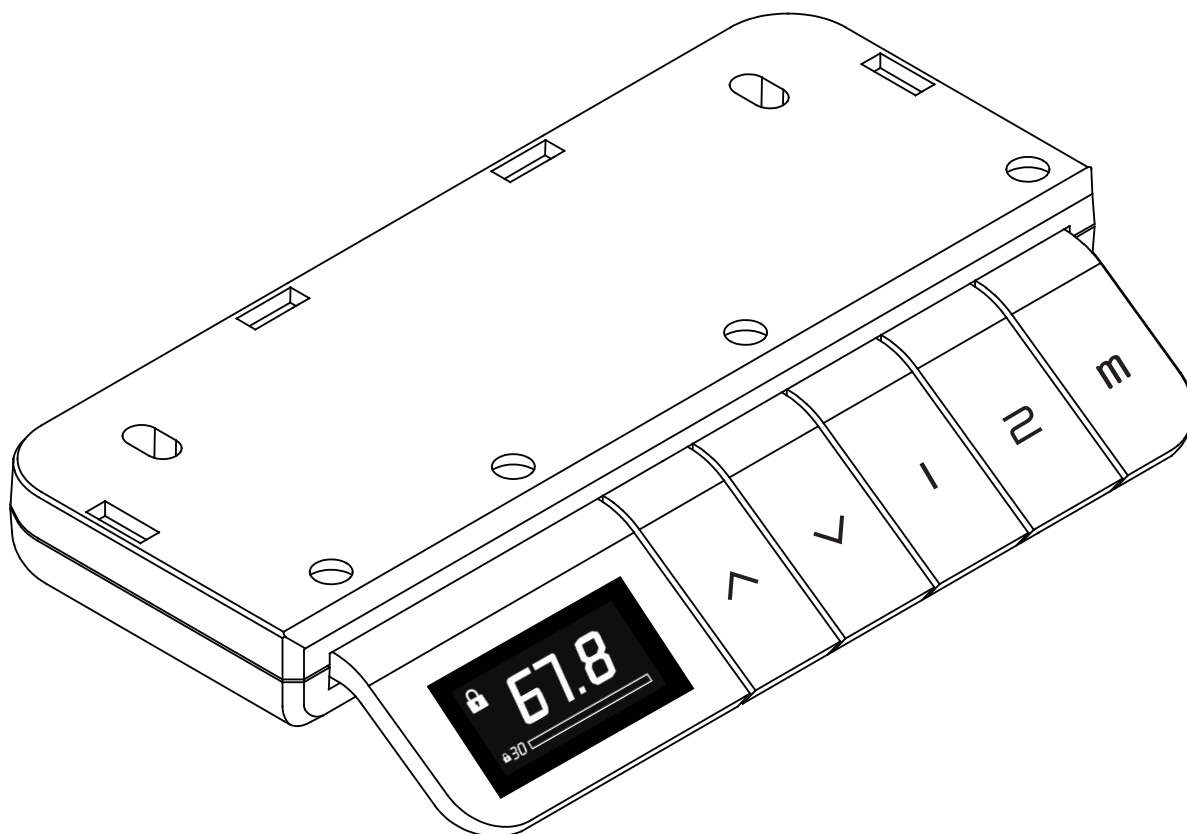

Zur Verwendung mit FEZiBO Desktops 48" und Größer

Für Montagehilfe, E-Mail: service@fezibo.com

Handschalterbedienung

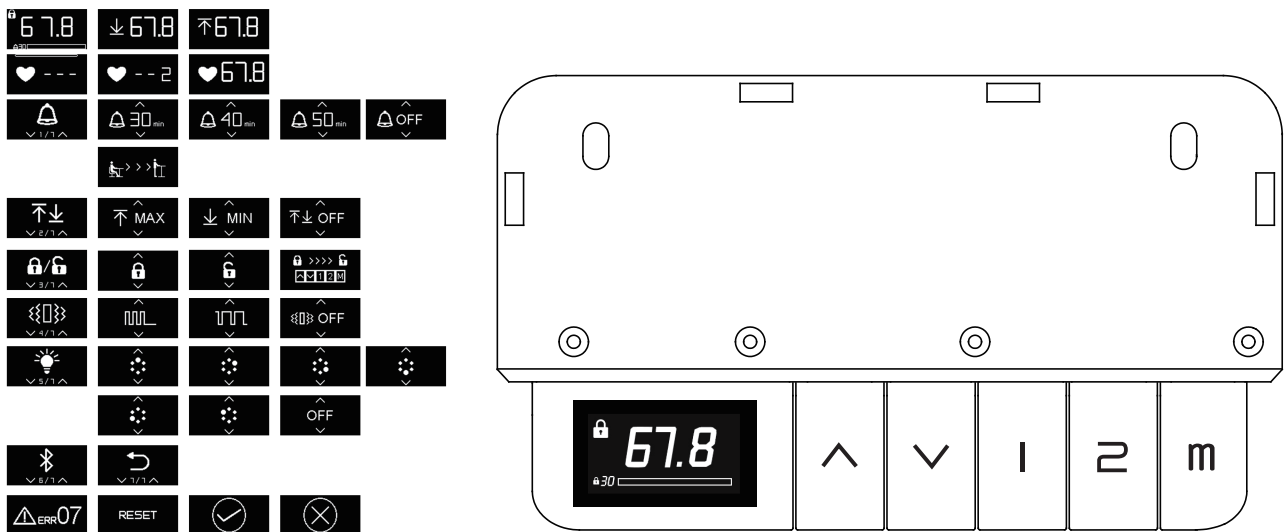

- Display für die Höhenanzeige





1. Das Display zeigt die Tischhöhe, einen Fortschrittsbalken für sitzende Tätigkeiten und eine Erinnerung an die manuelle Sperre an. Wenn sich der Handschalter auf Höhe des Displays befindet, wechselt er für etwa 5 Sekunden ohne Bedienung in die Logo-Anzeige und erlischt dann nach 5 Sekunden. Das Logo wird nicht angezeigt und erlischt nicht, wenn der Handschalter die Bewegungserinnerung, die Sperre und den Entsperrungsmodus der manuellen Controller-Sperre öffnet. Wenn das Stehpult die Ober- und Untergrenze erreicht, wird ein Symbol angezeigt.

- Funktion der Taste





2. Es gibt insgesamt 5 Tasten. Die Funktion jeder Taste zur Anzeige des Displays in der Höhe ist: Auf, Ab, Memoryposition 1 aufrufen, Memoryposition 2 aufrufen, Memorytaste. Drücken Sie die Taste M und es erscheint . Lassen Sie die Taste los und drücken Sie dann 1 oder 2, um die aktuelle Position als Memoryposition 1 oder 2 zu speichern. Drücken Sie die M-Taste und halten Sie 2,5 Sekunden lang gedrückt, um das Hauptmenü aufzurufen (Fortschrittsbalken zur Erinnerung an den Fortschritt). Nach der Eingabe wird das Interface der Bewegungserinnerung angezeigt. Drücken Sie die Auf- und Ab-Tasten, um das Seitenumblättern zu aktivieren, und drücken Sie die M-Taste, um das entsprechende Untermenü aufzurufen. Keine Bedienung für ca. 4 Sekunden oder drücken Sie die M-Taste im Return-Interface, um zur Höhenanzeige zurückzukehren.

Handschalterbedienung

- **Bewegungserinnerung**





3. Über den Bewegungserinnerungsbildschirm des Hauptmenüs  Drücken Sie die M-Taste, um das Untermenü für die Bewegungserinnerung zu öffnen und durch Umblättern der Seite die Zeit für die Bewegungserinnerung auszuwählen oder die Bewegungserinnerung abzustellen   . Drücken Sie die Return-Taste oder keine Bedienung für 4 Sekunden, um zum aktuellen Untermenü entsprechend dem Hauptmenü zurückzukehren. Das Bestätigungssymbol erscheint, nachdem die Bewegungserinnerungszeit bestätigt wurde  und zur Höhenanzeige zurückgekehrt ist, und ein Balken für die Bewegungserinnerung erscheint am unteren Bildschirmrand. Das Bildschirmsymbol wird angezeigt, wenn die Zeit zum Sitzen abgelaufen ist.  Und der Handschalter vibriert, die Aufwärtstaste blinkt rot. Heben Sie das Stehpult auf über 100 cm an und machen Sie die Zeit zum Sitzen frei.

- **Sperrfunktion**





4. Öffnen oder schließen Sie die Sperre   über das Sperre-Interface  des Hauptmenüs. Nach dem Öffnen der Sperre kehren Sie über das Symbol  zur Höhenanzeige zurück. Das kleine Sperrsymbol in der oberen linken Ecke der Höhenanzeige zeigt an, dass die manuelle Sperre geöffnet wurde. Keine Bedienung für 10 Sekunden nach dem Aufrufen des Sperrmodus, der Bildschirm zeigt nur das mittlere Sperrsymbol. Drücken Sie eine beliebige Taste und ein Entsperrsymbol wird angezeigt.  Die Entsperrung entsprechend der angezeigten Tastenfolge kann in die Höhenanzeige zurückgekehrt werden. Während des Entsperrungsvorgangs blinkt das Licht, um die nächste Taste aufzufordern. Der Entsperrungsschritt bleibt bei langem Drücken der nächsten Taste ohne Bedienung oder Fehler unverändert, und das Diagramm bleibt gleich.

Handschalterbedienung



- **Funktion der Ober- und Untergrenze**

5. Rufen Sie das Untermenü über das Interface der Ober- und Untergrenze im Hauptmenü  auf . Durch Umblättern die aktuelle Position als Ober- oder Untergrenze einstellen oder gleichzeitig die Ober- und Untergrenze abstellen   . Das Einstellen der Ober- und Untergrenze dauert etwa 3 Sekunden, das Abstellen etwa 1 Sekunde. Es wird ein Symbol angezeigt.  



- **Vibrationsauswahlfunktion**

6. Rufen Sie das Untermenü über die Vibrationsauswahl des Hauptmenüs  des Handschalters auf. Es gibt zwei Vibrationsoptionen (zur Bewegungserinnerung), drei kurze, eine lange  und eine homogene Vibration  . Vor der Auswahl verschiedener Vibrationsfrequenzen gibt es entsprechende Hinweise. Im Untermenü  können Sie die Vibration ausschalten.

- **Beleuchtungseinstellungsfunktion**







7. Rufen Sie das Untermenü über das Interface der Beleuchtungseinstellung des Hauptmenüs auf  . Wählen Sie die Beleuchtungsfarbe, indem Sie die Seite umblättern, wie gezeigt  . Es gibt insgesamt 6 Farben. Einzelheiten finden Sie in der beigefügten Tabelle. Bei der Auswahl im Menü leuchtet die entsprechende Farbe der M-Taste zur Aufforderung auf. Nach der Einstellung wird die Höhenanzeige zurückgegeben. Das Licht hat bei jedem Einschalten die standardmäßige blaue Farbe, wobei die vorherige Farbe unverändert bleibt.

- **Anormale Anzeige**

8. Wenn der Controller eine Ausnahme aufweist, erscheint die folgende Aufforderung  . Wenn die normale Arbeitszeit auf den Boden sinkt oder eine abnormale Zeit angezeigt wird, drücken Sie die Abwärtstaste 5 Sekunden lang und gehen Sie in den Reset-Modus, und die folgende Aufforderung wird angezeigt  . Rotes Licht blinkt bei anormalem Fehler und Reset-Modus. Der Reset erfolgt durch Drücken der Ab-Taste. Nach dem Reset wird die geöffnete Bewegungserinnerung und die Handschaltersperre deaktiviert.

Angehängte Liste

Beleuchtungseinstellungsfarbe

Symbol	Farbe
	Blau
	Cyan
	Indischrot
	Violett
	Dunkelorange
	Weiß
	/

Warum wählen Sie FEZIBO?

Viele ergonomische Bürolösungen sind mit hohen Kosten verbunden. Unser Ziel ist es, Ihnen eine erschwinglichere Lösung mit Innovation, Kreativität und Effizienz zu bieten, ohne Kompromisse bei der Qualität oder Benutzerfreundlichkeit einzugehen.



GARANTIELEISTUNGEN

Damit wir Ihnen den besten Service bieten können, vergessen Sie nicht, Ihr FEZiBO-Produkt zu registrieren, um Ihre Garantie zu bestätigen.

Es sind nur ein paar einfache Schritte nötig, und schon können Sie von FEZiBO auf eine breite Palette von Dienstleistungen zugreifen, wie z. B. Technische Unterstützung, Benachrichtigungen für neue Produkte, Werbeaktionen und Garantieleistungen.

Senden Sie Ihren Namen und Ihre Bestell-ID an service@fezibo.com

Weitere Produkte finden Sie auf unserer Website unter www.fezibo.com

Guide d'Opération

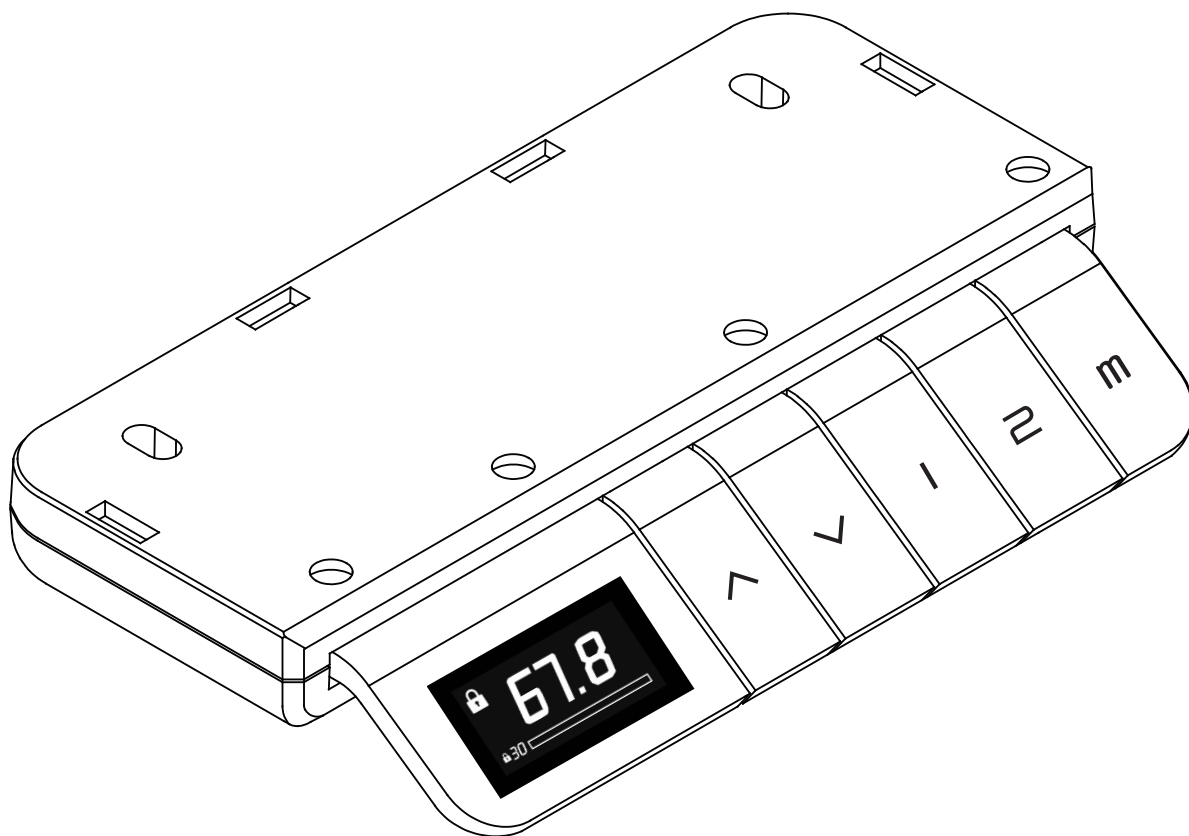

Pour utilisation des Bureaux FEZiBO 48 ou plus

Pour l'assistance à l'assemblage, email : service@fezibo.com



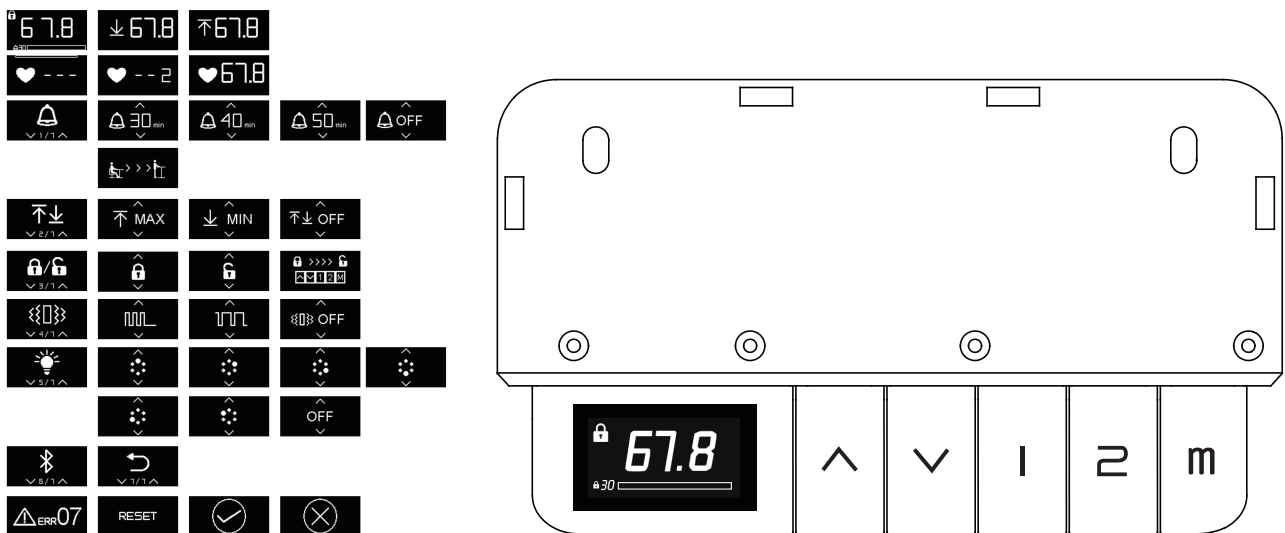

Description de la fonction de la télécommande

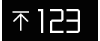
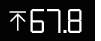

- **Écran d'affichage de la hauteur**



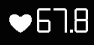

1. L'écran affiche le chiffre en hauteur, une barre de progression sédentaire et un rappel de verrouillage manuel . Lorsque la télécommande se trouve à la hauteur de l'écran d'affichage, on accèdera à l'écran d'affichage sans opération pendant environ 5 secondes, puis l'écran s'éteindra après 5 secondes. Le logo ne sera ni affiché ni éteint lorsque la télécommande activera le rappel sédentaire, l'écran de verrouillage de la télécommande et l'écran de déverrouillage pour le verrou du contrôleur manuel. Lorsque le bureau se déplace et atteint les limites supérieure et inférieure, une icône invite apparaîtra  .

- **Fonction du bouton**





2. Il y a 5 boutons au total. La fonction de chaque bouton pour afficher le hauteur sur l'écran est : haut, bas, aller à la position mémoire 1, aller à la position mémoire 2, bouton mémoire. Appuyez sur le bouton M et il affichera . Relâchez le bouton puis appuyez sur 1 ou 2 pour enregistrer la position actuelle comme position mémoire 1 ou 2 respectivement  . Appuyez sur le bouton M et appuyez longuement pendant 2,5 s pour entrer dans le menu principal (barre de progression pour rappeler la progression). Après l'entrée au menu principal, l'interface de rappel sédentaire s'affichera . Appuyez sur les boutons haut et bas pour tourner la page et appuyez sur le bouton M pour accéder au sous-menu correspondant. Aucune opération pendant environ 4 secondes ou appuyez sur le bouton M dans l'interface de retour pour revenir à l'affichage de la hauteur.

Description de la fonction de la télécommande

- **Rappel sédentaire**





3. Via l'écran de rappel sédentaire du menu principal . Appuyez sur le bouton M pour accéder au sous-menu rappel sédentaire et en tournant la page pour sélectionner l'heure du rappel sédentaire ou annuler le rappel sédentaire  . Appuyez sur le bouton retour ou aucune opération pendant 4 secondes pour revenir au sous-menu courant correspondant au menu principal. L'icône de confirmation apparaît après confirmation de l'heure de rappel sédentaire  et revenez à l'écran d'affichage de la hauteur, et une barre de rappel sédentaire apparaîtra au bas de l'écran. L'icône de l'écran affichera lorsque le temps de séance est écoulé . Et la télécommande vibrera, le bouton haut clignotera en rouge. Élevez le bureau à une hauteur de plus de 100 cm et effacez le temps de séance.

- **Fonction de verrouillage de la télécommande**



4.   Activez ou désactivez le verrouillage de la télécommande via l'interface de verrouillage de la télécommande  du menu principal. Après avoir activé le verrouillage de la télécommande, retournez à l'écran d'affichage de la hauteur via l'icône . La petite icône de verrouillage dans le coin supérieur gauche de l'écran d'affichage de la hauteur indique que le verrouillage manuel a été activé. Aucune opération pendant 10 secondes après l'entrée en mode de verrouillage, l'écran affiche seulement l'icône de verrouillage du milieu. Appuyez sur n'importe quel bouton et une icône de déverrouillage apparaîtra . Le déverrouillage suivant la séquence de boutons indiquée permet de retourner à l'écran d'affichage de la hauteur. Pendant le processus de déverrouillage, le voyant clignote pour indiquer le bouton suivant. L'étape de déverrouillage reste inchangée lorsque le bouton suivant est appuyé pendant longtemps sans opération ni erreur, et le schéma reste le même.

Description de la fonction de la télécommande



- **Fonction limite supérieure et inférieure**

5. Accédez au sous-menu via l'interface de limite supérieure et inférieure de la télécommande dans le menu principal . En tournant la page pour définir la position actuelle comme limite supérieure ou inférieure  , ou pour annuler l'ensemble des limites supérieure et inférieure en même temps. Il faut environ 3 s pour définir les limites supérieure et inférieure, et environ 1 s pour les annuler. Il y a une invite d'icône  .



- **Fonction de sélection de vibration**

6. Accédez au sous-menu via l'interface de sélection de vibration de la télécommande du menu principal . Il existe deux options de vibration (pour les rappels sédentaires), trois courtes vibrations et une longue  vibration homogène . Il affiche des indications de vibration correspondantes avant de sélectionner différentes fréquences de vibration. Sélectionnez « désactiver les vibrations » dans le sous-menu .

- **Fonction de réglage de l'éclairage**







7. Accédez au sous-menu via l'interface de réglage de l'éclairage de la télécommande Dans le menu principal . Sélectionnez la couleur d'éclairage en tournant la page, comme indiqué . Il y a 6 couleurs au total. Voir le tableau ci-joint pour plus de détails. Lors de la sélection dans le menu, la couleur correspondante du bouton M sera allumée pour invite. Après le réglage, on retournera à l'écran d'affichage de la hauteur. La lumière est de couleur bleue par défaut lors de chaque allumage, cependant, la couleur précédente reste inchangée.

- **Indication anormale**

8. Si le contrôleur a une exception, l'invite suivante apparaîtra . Lorsque le temps de travail normal se déplace vers le bas ou qu'un temps anormal apparaît, appuyez sur le bouton bas pendant 5s et entrez dans l'état de réinitialisation et l'invite suivante apparaîtra . Le voyant rouge clignote en cas d'erreur anormale et d'état de réinitialisation. Réinitialisez en appuyant sur le bouton bas. Après la réinitialisation, il désactivera le rappel sédentaire ouvert et le verrouillage de la télécommande.

Liste jointe

Couleur de réglage de l'éclairage

Icône	Couleur
	Bleu
	Cyan
	Rouge indien
	Violet
	Orange foncé
	Blanc
	/

Pourquoi choisir FEZIBO ?

De nombreuses solutions de bureau ergonomiques ont un coût élevé. Notre mission est de vous apporter une solution plus abordable avec innovation, créativité et efficacité sans compromettre la qualité ou la facilité d'utilisation.



SERVICES DE GARANTIE

Pour vous fournir le service qui vous convient, n'oubliez pas d'enregistrer votre produit FEZIBO pour confirmer votre garantie.

Cela ne prend que quelques étapes simples et vous pouvez ensuite accéder à une large gamme de services tels que le support technique, les alertes de nouveaux produits, les promotions et le service de garantie de FEZIBO.

Envoyez votre nom et votre numéro de commande à la messagerie suivante :
service@fezibo.com

Pour plus de produits FEZIBO, veuillez consulter notre site Web **www.fezibo.com**

Manual de operaciones

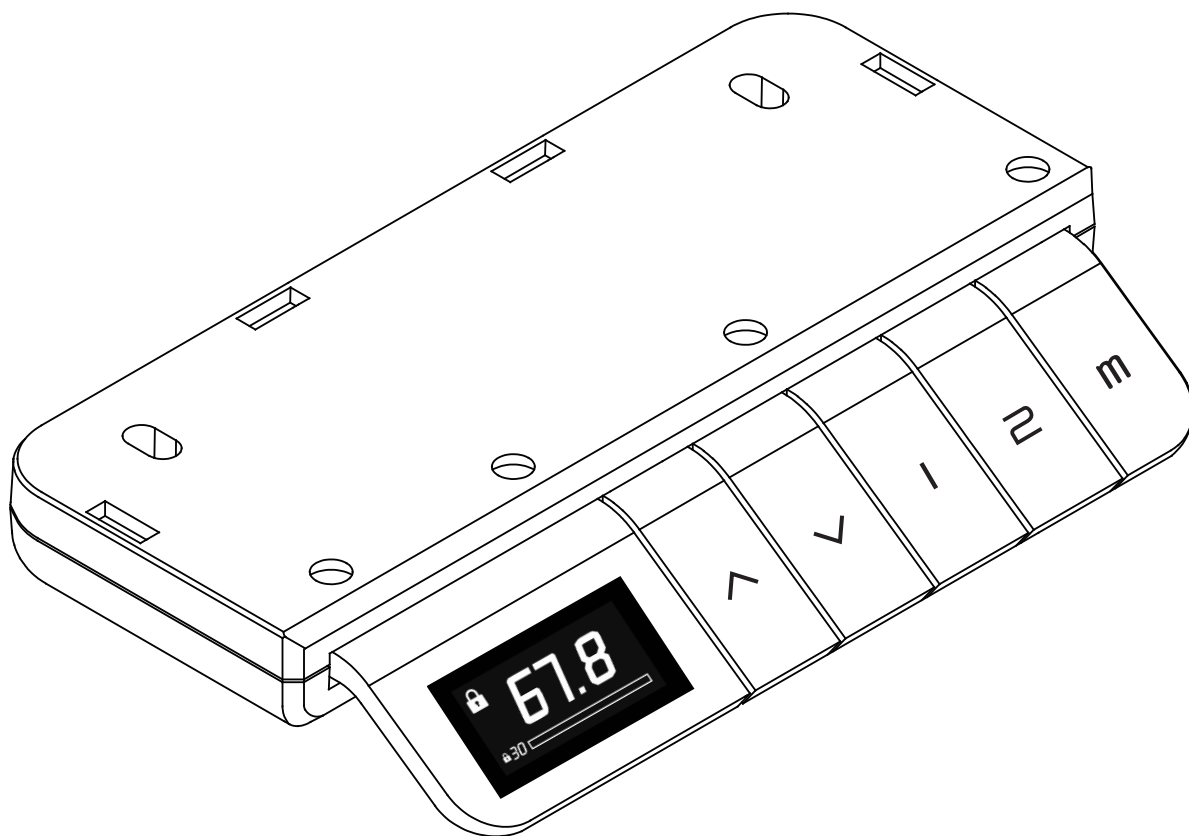

Para usar con Escritorio de 48" y más grande FEZiBO

Para asistencia de montaje, envíe un correo electrónico a service@fezibo.com

Descripción de Funciones del Teclado

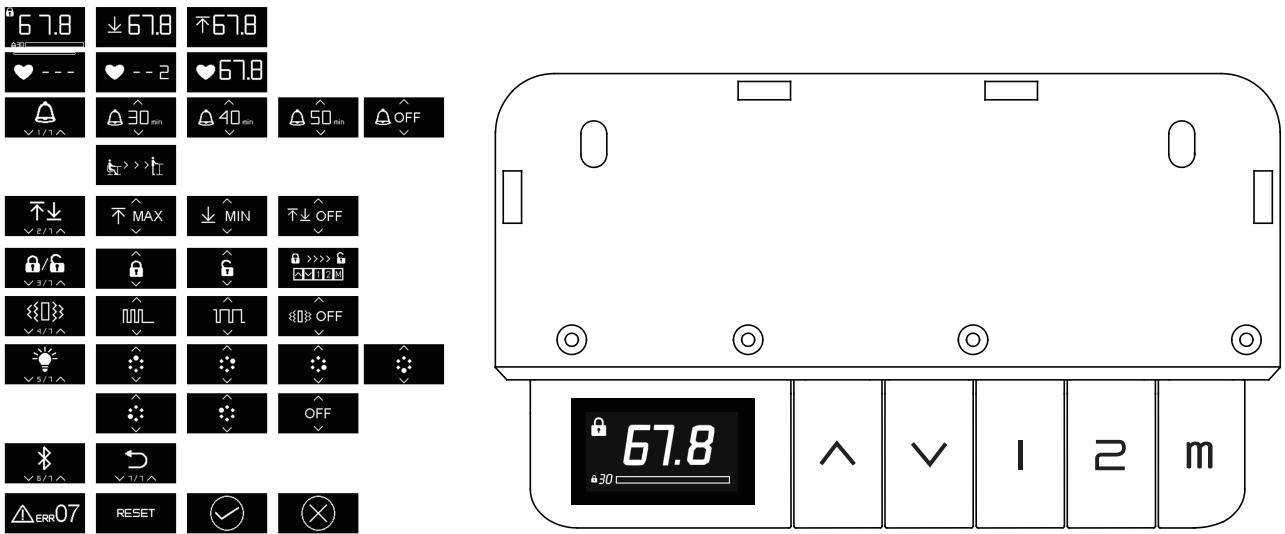

- **Pantalla de visualización de altura**





1.La pantalla muestra las cifras de altitud, la barra de progreso sedentario y el recordatorio de bloqueo manual **67.8** . Cuando el teclado está a la altura en la pantalla de visualización, se entrará a la interfaz de logotipo en caso de sin operación durante aproximadamente 5 segundos y la interfaz se apagará después de 5 segundos. Cuando se abre la interfaz del desbloqueo del recordatorio para sentarse, el bloqueo del teclado y el bloqueo del controlador manual en el teclado, el logotipo no se mostrará y no se apagará. Cuando el escritorio de pie alcanza el límite superior e inferior, hay un icono de aviso **123 67.8** .

- **Función del botón Hay 5 botones en total**





2.La función de cada botón en la pantalla de visualización de altura es: arriba, abajo, movera la posición de memoria 1, mover a la posición de memoria 2, botón de memoria. Presione el botón M y así tiene **♥ ---** . Suelte y luego presione 1 ó 2 para registrar la posición actual como la posición de memoria 1 ó 2 respectivamente **♥ -- 2 ♥ 67.8** . Presione el botón M , y mantenga presionado 2,5s para entrar en el menú principal (barra de progreso para recordar el progreso). Después de ingresar, se mostrará la inferfaz de recordatorio para sentarse **1/6** . Presione el botón de arriba y abajo para pasar las páginas, y presione el botón M para entarar en el submenú correspondiente. En caso de no tener operación durante aproximadamente 4 segundos, o presionar el botón M en la interfaz de retorno, se regresará a la visualización de altura.

Descripción de Funciones del Teclado

- Recordatorio para sentarse





3. Configure mediante la interfaz de recordatorio para sentarse del menú principal . Presione el botón M para ingresar al submenú de recordatorio para sentarse, y pase las páginas para seleccionar el tiempo del recordatorio para sentarse o cancelarlo  . Presione el botón de retorno o no opere durante 4 segundos, para volver al submenú actual correspondiente al menú principal. Después de confirmar la hora del recordatorio para sentarse, se aparecerá un icono de confirmación , y se vuelve a la interfaz de altura, y la barra de recordatorio para sentarse se mostrará en la parte inferior de la pantalla . El icono de la pantalla se mostrará cuando se acabe el tiempo para sentarse. Y el teclado vibrará, el botón de arriba parpadeará con una luz roja. Eleve el escritorio de pie a más de 100 cm y libere el tiempo de sentarse.





- Función de bloqueo del teclado



4. Abra o cierre el bloqueo de teclado   mediante la interfaz de bloqueo de teclado  en el menú principal. Después de abrir el bloqueo de teclado, vuelva a la visualización de altura mediante el icono . El pequeño icono de bloqueo en la esquina superior izquierda de la interfaz de altura indica que se ha abierto el bloqueo manual. Si no se realiza ninguna operación dentro de los 10 segundos después de entrar en el modo de bloqueo, solo se muestra el icono de bloqueo del medio en la pantalla. Presione cualquier botón y se aparecerá un icono de desbloqueo . Desbloquee de acuerdo con la secuencia de botones mostrada para volver a la interfaz de altura. Durante el proceso de desbloqueo, la luz parpadea para indicar el siguiente botón. Al mantener presionado el siguiente botón durante mucho tiempo sin operación o error, y el diagrama sigue siendo el mismo, el paso de desbloqueo permanece sin cambios.



Descripción de Funciones del Teclado

- **Función de límite de arriba y abajo**

5. Ingrese al submenú a través de la interfaz de límite superior e inferior del teclado en el menú principal . Pase las páginas para establecer la posición actual como el límite superior o límite inferior, o para cancelar la configuración del límite superior y el límite inferior al mismo tiempo . Se necesitan aproximadamente 3 s para establecer los límites superior e inferior, y aproximadamente 1 s para cancelar. Hay un aviso de icono  .
- **Función de selección de vibración**

6. Ingrese al submenú a través de la interfaz de selección de vibración del teclado del menú principal . Hay dos opciones de vibración (utilizadas para recordatorio para sentarse), tres vibraciones cortas y una larga  y la vibración uniforme . Hay sugerencias de vibración correspondientes antes de seleccionar las diferentes frecuencias de vibración. Seleccione apagar la vibración en el submenú .
- **Función de ajuste de iluminación**

7. Ingrese al submenú a través del ajuste de luz del teclado del menú principal . Seleccione el color de luz pasando las páginas, como se muestra . Hay 6 colores en total. Consulte la tabla adjunta para obtener más detalles. Al seleccionar en el menú, el color correspondiente del botón M se iluminará para el aviso. Se volverá a la interfaz de altura después de la configuración. Cada vez de encendido, la luz es el color azul predeterminado, manteniendo el color anterior sin cambios.
- **Indicación anormal**

8. Si el controlador es anormal, se aparecerá el siguiente mensaje . Cuando el tiempo de trabajo normal desciende al fondo, o ocurre un tiempo anormal, presione el botón hacia abajo durante 5 segundos para ingresar al estado de reinicio, y se aparecerá el siguiente mensaje . La luz roja parpadea en estado de error anormal y restablecimiento. Presione el botón para reiniciar. Después del reinicio, se desactivarán el recordatorio para sentarse y el bloqueo del teclado.

Lista adjunta

Color de ajuste de iluminación

Icon	Color
	Azul
	Cian
	Rojo indio
	Violeta
	Naranja oscuro
	Blanco
	/

Por qué elegir FEZIBO?

Muchas soluciones ergonómicas de oficina tienen un coste elevado. Nuestra misión es brindarle soluciones más asequibles con la innovación, la creatividad y la eficiencia sin afectar la calidad o la facilidad de uso.



SERVICIOS DE GARANTÍA

Para brindarle el servicio, no olvide registrar su producto FEZIBO para confirmar su garantía.

En solo unos sencillos pasos, puede obtener una amplia gama de servicios de FEZIBO, como soporte técnico, recordatorios de nuevos productos, promoción y servicios de garantía.

Envíe su nombre e ID de pedido a service@fezibo.com

Para más productos FEZIBO, consulte a nuestro sitio web: www.fezibo.com

Guida Operativa

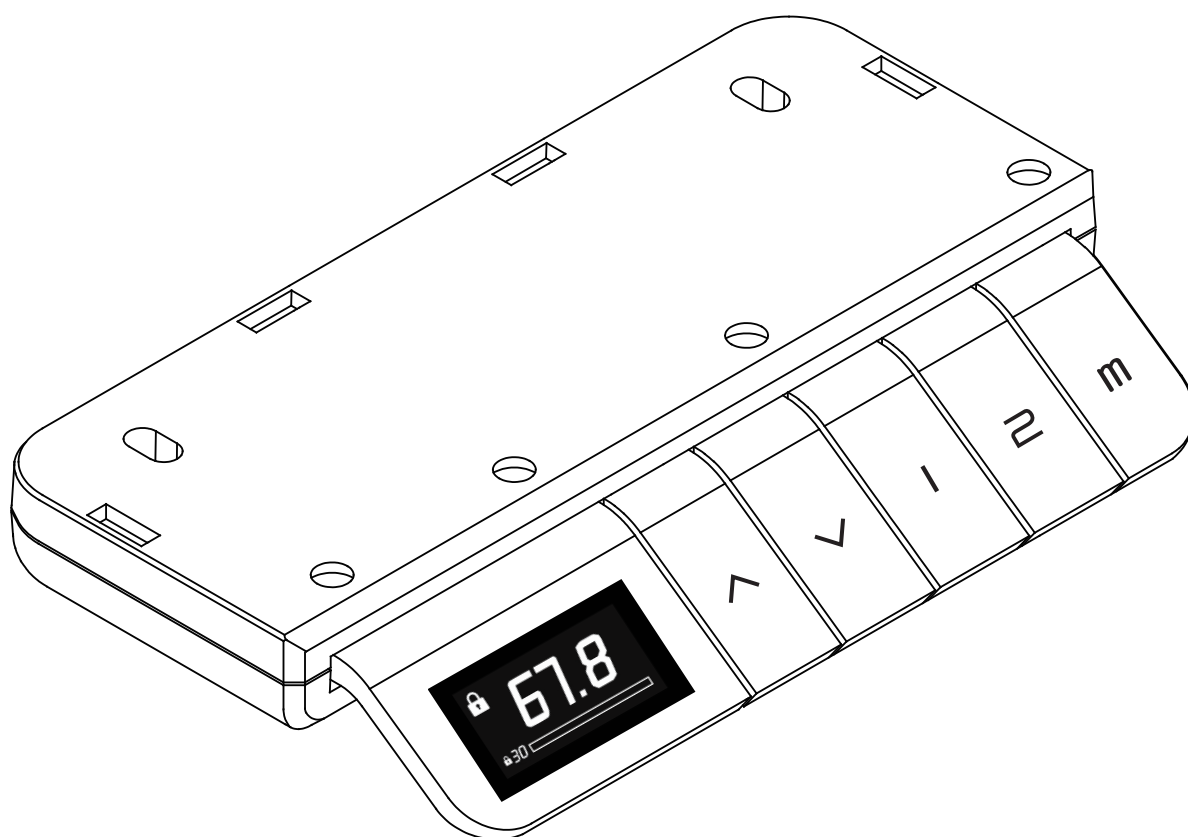



Per scrivanie FEZIBO da 48 pollici e più grandi

Per assistenza al montaggio, inviare un'e-mail a service@fezibo.com

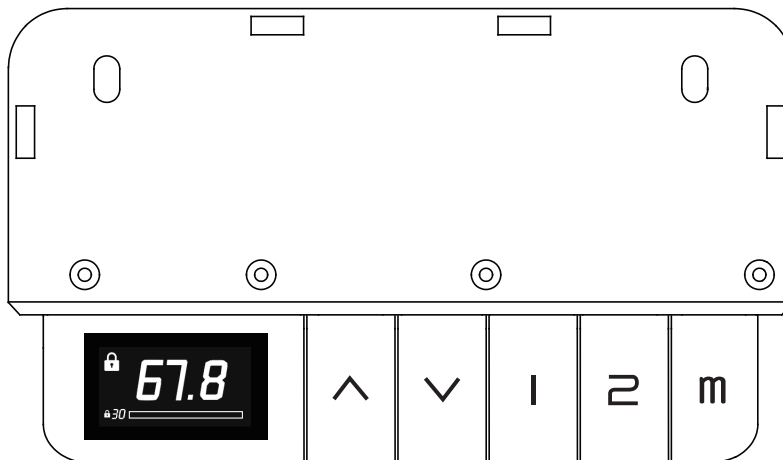
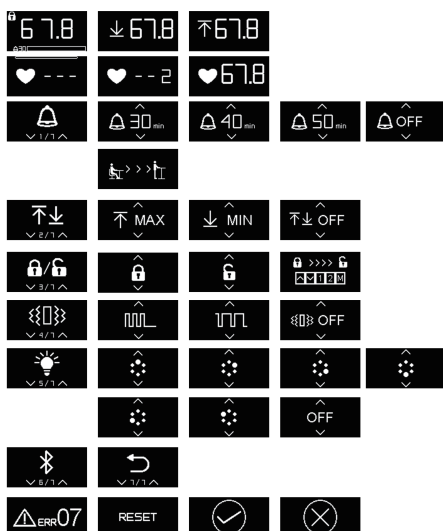



Descrizione dei comandi manuali



- **Display di visualizzazione dell'altezza**





1. Il display mostra l'altezza, una barra di progresso della sedentarietà e il promemoria del blocco manuale . Quando la scrivania arriva all'altezza prefissata sullo schermo di visualizzazione, apparirà il logo per circa 5 secondi; lo schermo si spegnerà dopo 5 secondi se non sono effettuate operazioni. Il logo non viene visualizzato e il display non si spegne quando sono impostate le funzioni di avviso di sedentarietà, blocco dei comandi e la schermata di sblocco manuale del regolatore. Quando la scrivania raggiunge i limiti superiore e inferiore, viene visualizzata l'icona .

- **Funzioni dei pulsanti**





2. Sono presenti 5 pulsanti in totale. La funzione di ogni pulsante è la seguente: regolazione dell'altezza su, giù, portarsi alla posizione di memoria 1, portarsi alla posizione di memoria 2, pulsante di memoria. Premendo il tasto M viene visualizzato . Rilasciare e poi premere 1 o 2 per registrare la posizione corrente come posizione di memoria 1 o 2 rispettivamente  . Premere il pulsante M a lungo (2,5 s) per entrare nel menu principale (barra di progresso della sedentarietà). A questo punto verrà visualizzata l'interfaccia dell'avviso di sedentarietà . Premere il pulsante su e giù per cambiare schermata, e premere il pulsante M per entrare nel sottomenu corrispondente. Per tornare alla visualizzazione dell'altezza non eseguire alcuna operazione per circa 4 secondi o premere il pulsante M.

Descrizione dei comandi manuali

- **Avviso di sedentarietà**

3. Dalla schermata dell'avviso di sedentarietà del menu principale . Premere il pulsante M per entrare nel sottomenu dell'avviso di sedentarietà; cambiare la schermata e selezionare il periodo di avviso di sedentarietà o annullare l'avviso di sedentarietà  . Premere il pulsante di ritorno o non effettuare alcuna operazione per 4 secondi per tornare al sottomenu corrente del menu principale. L'icona di conferma apparirà dopo aver confermato il periodo di avviso di sedentarietà  e il display torna a visualizzare dell'altezza, con la barra di avviso di sedentarietà nella parte inferiore. L'icona sul display viene visualizzata quando il tempo per rimanere seduti è scaduto . I comandi vibreranno e il pulsante "su" lampeggerà con luce rossa. Alzare la scrivania a più di 100 cm farà ripartire il timer dell'avviso.

- **Funzione di blocco dei comandi**

4. Attivare o disattivare il blocco dei comandi   attraverso l'interfaccia di blocco  del menu principale. Dopo aver disattivato manualmente il blocco dei comandi, tornare alla visualizzazione dell'altezza attraverso l'icona . La piccola icona del lucchetto nell'angolo superiore sinistro del display indica che è stato disattivato manualmente il blocco dei comandi. Se non viene eseguita alcuna operazione per 10 secondi dopo essere entrati in modalità di blocco, lo schermo mostrerà solo l'icona del lucchetto centralmente. Premere un pulsante qualsiasi e apparirà l'icona di sblocco . Lo sblocco effettuato premendo la sequenza di pulsanti indicata riporterà la visualizzazione dell'altezza. Durante il processo di sblocco, il pulsante da premere avrà una luce lampeggiante. Lo sblocco non avviene se un pulsante viene premuto a lungo, se non viene eseguita alcuna operazione o in caso di errore nella sequenza; la visualizzazione sul display rimarrà invariata.

Descrizione dei comandi manuali

- **Funzione limite superiore e inferiore**

5. Accedere al sottomenu attraverso l'interfaccia di limite superiore e inferiore dei comandi nel menu principale . Il comando di cambio di schermata permette di impostare la posizione corrente come limite superiore o inferiore, o di annullare l'impostazione del limite superiore e inferiore allo stesso tempo  . Sono necessari circa 3s per impostare il limite superiore e inferiore, e circa 1s per annullarlo. Per la conferma è necessario selezionare un'icona  .
- **Funzione di selezione della vibrazione**

6. Accedere al sottomenu attraverso l'interfaccia di selezione della vibrazione dei comandi dal menu principale . Sono disponibili due opzioni di vibrazione (per gli avvisi di sedentarietà), tre vibrazioni brevi e una lunga  e una vibrazione a frequenza costante . Prima di selezionare le diverse frequenze di vibrazione viene mostrato un esempio. Selezionare disattivare la vibrazione dal sottomenu .
- **Funzione di regolazione dell'illuminazione**

7. Entrare nel sottomenu attraverso l'interfaccia di regolazione della luce dei comandi dal menu principale . Selezionare il colore dell'illuminazione cambiando la schermata, come mostrato . Sono disponibili 6 colori in totale. Vedere la tabella allegata per i dettagli. Quando si seleziona nel menu, il colore corrispondente del pulsante M questo verrà illuminato. Dopo l'impostazione, sarà ripristinata la visualizzazione dell'altezza. La luce preimpostata ad ogni accensione è di colore blu, lasciando inalterato il colore precedente.
- **Indicazione di anomalia**

8. Se il regolatore rileva un problema, apparirà il seguente messaggio . Quando sul display appaiono valori anomali premere il pulsante "giù" per 5 secondi per iniziare il reset; apparirà il seguente messaggio . La luce rossa lampeggerà in caso di errore anomalo durante il reset. Azzerare premendo il pulsante "giù". Dopo il reset, si riavvierà il tempo dell'avviso di sedentarietà e il blocco dei comandi.

Lista allegata

Regolazione del colore dell'illuminazione

Icona	Colore
	Blu
	Ciano
	Rosso indiano
	Viola
	Arancione scuro
	Bianco
	/

Perché scegliere FEZIBO?

Molte soluzioni ergonomiche per l'ufficio hanno un costo elevato. La nostra missione è quella di offrirvi una soluzione più accessibile, innovativa, creativa ed efficiente senza compromettere la qualità o la facilità d'uso.



SERVIZI DI GARANZIA

Per ricevere il miglior servizio, non dimenticare di registrare il tuo prodotto FEZIBO per attivare la garanzia.

Bastano pochi semplici passi per accedere a una vasta gamma di servizi come il supporto tecnico, gli avvisi sui nuovi prodotti, le promozioni e i servizi di garanzia di FEZIBO.

Invia il tuo nome e l'ID dell'ordine a service@fezibo.com

Per altri prodotti FEZIBO, visita il nostro sito web: www.fezibo.com
