

Spindal Rocking Chair #SPIN

Assembly Instructions

1.  **Warning !**

Adult Assembly Required

2.  **Warning : Choking Hazard Adult Assembly Required.** Small parts may be necessary in the assembly of this product. Please pay special attention to these components when unpacking the item. Unassembled components can pose a choking risk to children 3 and below. Periodically check to ensure that all of components are sufficiently secure . Over time,the hardware may become loose, so retighten the hardware when necessary .









3.Remove hardware from box and sort by size.

4.Please check to see that all hardware and parts are present prior to the start of assembly.

5.Do not attempt to repair or modify parts that may arrived damage. Please contact the company where the item was purchased for a replacement piece .

6.This product is for home use only and not intended for commercial use.

1410

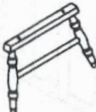
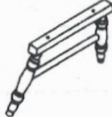
HARDWARE LIST				PARTS IDENTIFICATION			
1	Ø 3/16"X32mm		9PCS	A	BACK PANEL		1PCS
2	Ø 3/16"X50mm		2PCS				
3	Ø 3/16"X63mm		4PCS	B	ARM POST (LEFT&RIGHT)		2PCS
4	Ø 3/16"X10mm		6PCS	C	RUNNER (LEFT&RIGHT)		2PCS
5	M3		1PC	D	CHAIR SEAT		1PC
				E	REAR LEG (SMALLER)		1PC
				F	FRONT LEG (LARGER)		1PC

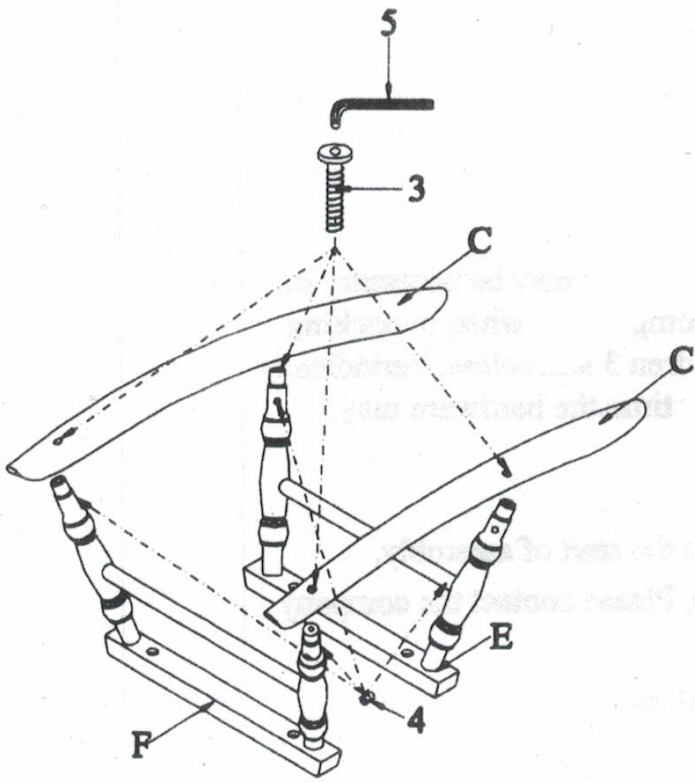

STEP 3

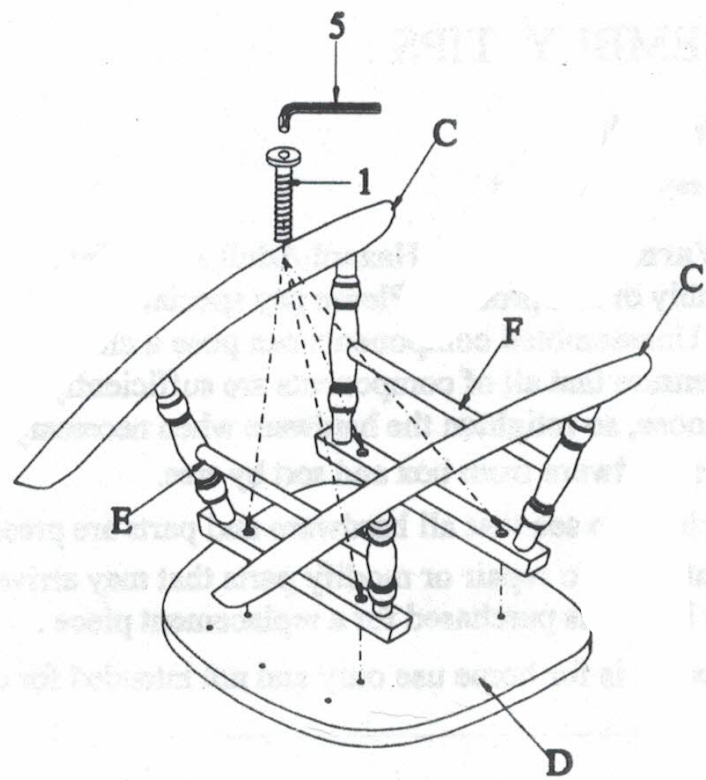

STEP 4

