

# BladderScan<sup>®</sup>

Bladder Volume Instrument



## BVI 9400 User's Manual



# BladderScan<sup>®</sup> BVI 9400

Bladder Volume Instrument

## User's Manual

**CAUTION:** In the United States, federal law restricts this device to use by or on the order of a physician.

Copyright © 2008 by Verathon Inc.. All rights reserved. No part of this User's Manual may be copied or transmitted by any method without the express written consent of Verathon Inc..

Verathon<sup>®</sup>, Verathon Medical<sup>®</sup>, BladderScan<sup>®</sup>, ScanPoint<sup>®</sup>, Sontac<sup>®</sup>, and NeuralHarmonics™ are either trademarks or registered trademarks, and Total Reliability<sup>SM</sup> Plan is a service mark of Verathon Inc..

Bluetooth<sup>®</sup> word mark and logos are owned by the Bluetooth SIG, Inc. and any use of such marks by Verathon<sup>®</sup> is under license.

Cidex<sup>®</sup> is a registered trademark of Advanced Sterilization Products.

Sporocidin<sup>®</sup> is a registered trademark of Aporocidin International.

All other brand and product names are trademarks or registered trademarks of their respective owners.

The BladderScan<sup>®</sup> technology described in this manual is protected by U.S. Patent Numbers 4,926,871, 5,235,985, 6,676,605, and 6,884,217. The ScanPoint<sup>®</sup> technology described in this manual is protected by U.S. Patent Number 6,569,097. The Sontac<sup>®</sup> ultrasound coupling pad described in this manual is protected by U.S. Patent Number 5,782,767. Other international patents pending.

Information in this *User's Manual* may change at any time without notice. For the most up-to-date information, see the online manuals at <http://www.verathon.com>. Examples described or illustrated in this *User's Manual* are fictitious and do not in any way represent real patient or exam data.

**Corporate Headquarters**

20001 North Creek Parkway  
Bothell, WA 98011  
USA  
800.331.2313 (US and Canada only)  
425.867.1348  
Fax: 425.883.2896

**Verathon Medical (Japan) K.K.**

Executive Tower Azabudai 7F  
1-4-3 Azabudai  
Minato-ku, Tokyo 106-0041  
Japan  
+81.3.3560.3501  
Fax: +81.3.3560.3502

**Verathon Medical (Europe) B.V.**

**EC REP**  
Boerhaaveweg 1  
3401 MN IJsselstein  
The Netherlands  
+31.30.68.70.570  
Fax: +31.30.68.70.512

**Verathon Medical (France)**

**Postal Address**  
BP 10039  
F-67012 Strasbourg Cedex  
France  
+33.3.88.60.14.12  
Fax: +33.3.88.60.46.87

**Office Address:**

Espace Europeen de l'Entreprise  
2 allée d'Oslo  
67300 Schiltigheim

**Verathon Medical (United Kingdom) Ltd.**

The Granary Manor Farm Courtyard  
Aston Sandford, Aylesbury  
Buckinghamshire HP17 8JB  
United Kingdom  
+44.1844.299.207  
Fax: +44.1844.299.218



**BVI 9400 User's Quick Reference**

Noninvasive, Accurate, Reliable, Easy to Use



**1**

**Turn on the BladderScan® BVI 9400 by pressing the POWER ON/OFF button.**

**2**

**Select scanning mode**

The BladderScan BVI 9400 is designed to scan in three patient-specific modes. Select the proper exam mode to ensure the accuracy of your scan. Simply press the button repeatedly until the desired setting appears:

-  Select to scan a male patient, or a female patient who has had a hysterectomy
-  Select to scan a female patient who has not had a hysterectomy
-  Select to scan a small child under 48 inches (122cm) tall and weighing less than 60 lbs (27kg)

**3**

**With the patient supine, apply gel**

Have the patient lie in the supine position with abdominal muscles relaxed.

Palpate the patient's symphysis pubis (pubic bone). Place an ample quantity of gel (with as few air bubbles as possible) midline on the patient's abdomen, approximately one inch (3 cm) above the symphysis pubis.

**4**

**Aim toward the bladder**

Standing at the patient's right side, place the Probe on the gel and aim toward the expected location of the bladder. For most patients, this means tilting the Probe slightly toward the patient's coccyx (tailbone) so the scan clears the pubic bone.

**5**

**Press the SCAN button**

Press the SCAN button, located on the underside of the Probe. As the scan progresses, sections of the bladder will appear on the console screen. When you hear the end-scan tone, the scan is complete.

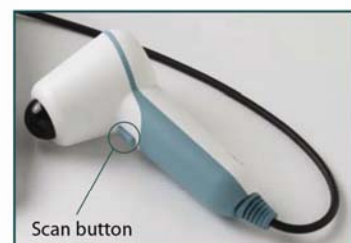

www.verathon.com <https://my.scanpoint.com>

For more information, call 800.331.2313 (in the U.S. and Canada) or contact your local Verathon Medical® representative. BladderScan®, ScanPoint®, Verathon®, and Verathon Medical® are registered trademarks of Verathon Inc. in the US and other countries. Copyright © 2008 by Verathon Inc. All rights reserved.





## BVI 9400 User's Quick Reference

Noninvasive, Accurate, Reliable, Easy to Use

**6**

### Verify the scan

If the scan is "on target" all 8 arrows will flash on the Probe screen, and the bladder will be shown in the center of the crosshairs on the Console screen. Since no re-aiming is needed, no arrows will appear on the Console screen.

**6a**

### Re-aiming

If the scan is "off target" the Probe will show an arrow indicating the direction to move the Probe to be "on target." If the arrow is solid, it means you are slightly "off target." If the arrow is flashing, it means you are significantly "off target" and must re-aim and re-scan. On the Console, the bladder will not be on the crosshairs, and there will be an arrow pointing in the direction for re-aiming.

**6b**

### To re-aim

To re-aim, note that the small dot at "6 o'clock" on the Console target represents the feet of the patient. The "12 o'clock" position represents the head of the patient and the upper left quadrant (9-12 o'clock) represents the right shoulder of the patient. This orientation should help you in re-aiming the Probe to capture the complete bladder in the ultrasound "cone."

**6c**

### Pubic Bone

You may also see a screen that indicates the pubic bone is "inside" the ultrasound cone. If this occurs, you may want to re-aim and re-scan. Although the bladder may be shown as centered in the ultrasound cone, and your measurement could be complete, there is a possibility that the pubic bone is obscuring some of the bladder. By re-aiming, you can ensure you have captured the bladder fully inside the ultrasound cone.

**7**

### Save, review and print exam results

To save the exam, you must annotate it.

To annotate, press and release the RECORD button on the Console. When you see the RECORD button icon turn to a STOP button icon, record your patient information by speaking into the Probe microphone. Press the STOP button on the Console. When the hourglass icon disappears, press the LISTEN button to replay the annotation.

To review the images of your scan, press the REVIEW button (you must first save the exam before you can review it).

To print exam results via on-board printer, press the PRINT button.

To perform another exam, press the HOME button.

**8**

### Finish exam

Once you have completed the scan, wipe the ultrasound gel off the patient and the Probe.

For ScanPoint® subscribers, logging on to ScanPoint® automatically transfers and saves your annotated exams.

To order additional rolls of paper (0800-0319) or batteries (0400-0066), contact Customer Care at 800.331.2313.

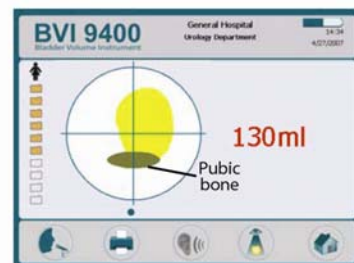
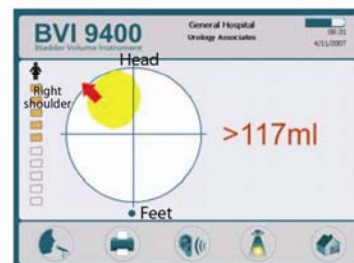
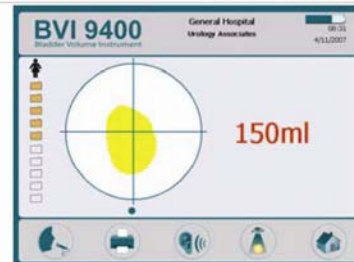

www.verathon.com <https://my.scanpoint.com>

For more information, call 800.331.2313 (in the U.S. and Canada) or contact your local Verathon Medical® representative.  
Verathon Corporate Headquarters: 20001 North Creek Parkway, Bothell, WA 98011, USA. Phone: +1.425.867.1348  
VM Europe B.V.: Boerhaaveweg 1, 3401 MN IJsselstein, The Netherlands, Phone: +31.30.68.70.570

0900-1446-02-60



**NOTE: This procedure requires ScanPoint® with QuickPrint Imaging Technology Software. If your BladderScan® BVI 9400 requires calibration, and you're not using ScanPoint® with QuickPrint, please contact Verathon® Technical Support at 1.800.331.2313 (US & Canada) or 425.867.1348 (International).**



## BVI 9400 Calibration Quick Reference

Noninvasive, Accurate, Reliable, Easy to Use

The entire calibration process may take up to 15 minutes. You may calibrate your instrument as often as you like; you do not have to wait for the next scheduled calibration date. However, at a minimum, you must calibrate the instrument every 12 months.

1

### Prepare for Calibration

Set up the calibration tank in a location that is within 10 feet of Charger and Wireless Hub.

Place the calibration tank on a flat, nonreflective surface and remove the lid. Pour clean, room temperature water into the container, filling to the indicator mark. Make sure the water contains a minimal amount of bubbles. Place the spiral-shaped target in the container, using the notches to position target correctly. Replace the lid on the calibration container.



2

### Place the probe

Place the Probe in the cutout in the top of the calibration tank. Make sure the black tip of the Probe is submerged in the water.



3

### Open ScanPoint® QuickPrint

From your desktop, open QuickPrint by double-clicking the QuickPrint icon.



4

### Establish BVI 9400 - QuickPrint connection

Press the ScanPoint® button on the BVI 9400.

On the QuickPrint screen, click the FIND NEW button. When QuickPrint establishes a connection with the BVI 9400, an icon will appear along the left menu.

ScanPoint® button

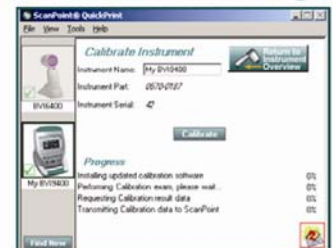
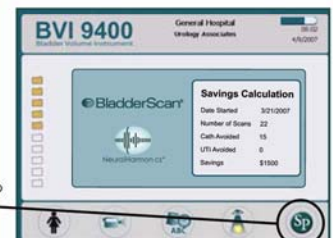

www.verathon.com <https://my.scanpoint.com>

For more information, call 800.331.2313 (in the U.S. and Canada) or contact your local Verathon Medical® representative. ScanPoint®, BladderScan®, Verathon®, and Verathon Medical® are registered trademarks of Verathon Inc. in the US and other countries. Copyright © 2007 by Verathon Inc. All rights reserved.

5

### Calibrate instrument

From the Tools menu, select Calibrate Instrument. When the Calibration screen opens, click the CALIBRATE button. ScanPoint® then automatically scans and analyzes the calibration target.

**IMPORTANT!** Do not remove the Probe from the calibration chamber until four arrows appear on the Probe's LCD screen. Do not disconnect the Charger and Wireless Hub from the computer or otherwise break the connection between the BVI 9400 and the ScanPoint® host computer until all processing is complete.



+

### Successful calibration

If ScanPoint® was able to locate the calibration target, the instrument analyzes the scan data to ensure that it meets the calibration parameters. If necessary, the instrument automatically rescans the phantom. When calibration is complete, a 'Calibration Successful' message is displayed on your computer.

To print a record of the calibration, click: [Click Here for Printable Certificate of Calibration](#).



-

### Failed calibration

If ScanPoint® was unable to locate the calibration target, it displays an error message and instructs you to ensure that the calibration chamber has enough water and that the Probe is seated properly in the calibration system. You may choose to calibrate again or to quit the calibration process.

**NOTE:** If you are unable to calibrate, contact your local Verathon Medical® representative or Verathon Medical® Customer Care at 1.800.331.2313.

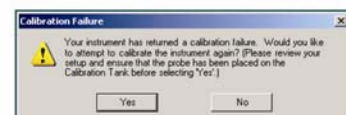

6

### End calibration

To terminate the calibration procedure and end communication with the ScanPoint®, press the CANCEL (X) button on the BVI 9400.

Remove the Probe from the calibration chamber lid and dry it with a clean, soft cloth.



To order additional rolls of paper (0800-0319) or batteries (0400-0066), contact Customer Care at 800.331.2313.

[www.verathon.com](http://www.verathon.com) <https://my.scanpoint.com>

For more information, call 800.331.2313 (in the U.S. and Canada) or contact your local Verathon Medical® representative. Verathon Corporate Headquarters: 20001 North Creek Parkway, Bothell, WA 98011, USA. Phone: +1.425.867.1348  
 VM Europe B.V.: Boerhaaveweg 1, 3401 MN IJsselstein, The Netherlands, Phone: +31.30.68.70.570

0900-1447-01-60





## Table of Contents

<b>Quick Reference</b> .....	<b>5</b>
<b>President’s Statement</b> .....	<b>13</b>
<b>Important Information</b> .....	<b>14</b>
Product Description .....	14
Intended Use Warnings and Cautions.....	14
Biological Safety .....	14
Statement of Prescription.....	15
Statement of Intended Use .....	15
Contraindications (U. S. Only) .....	15
Bluetooth® Wireless Technology.....	16
<b>Introducing the BladderScan® BVI 9400</b> .....	<b>17</b>
Product Description .....	17
BladderScan® Parts and Features .....	18
Probe Components .....	19
Console Components .....	19
Battery Charger/Wireless Hub.....	20
Parts and Accessories.....	21
<b>Getting Started</b> .....	<b>22</b>
Unpack the Box and Check the Components .....	22
Charge the Batteries.....	22
Install a Battery Pack in the Console.....	23
Battery Care .....	23
Enter the Clinic Name.....	24
Set the Date and Time.....	26
Setting General Preferences and Savings Preferences .....	27
Load a Roll of Thermal Paper .....	27
Assemble the Medical Cart .....	28
Medical Cart Parts List.....	28
Install the BladderScan® on the Optional Mobile Cart.....	30
Install the ScanPoint® with QuickPrint Software (Optional).....	30
Watch the Training Video .....	31

<b>Displays, Controls, and Indicators</b> .....	<b>32</b>
Console Displays and Button Functions.....	32
Home Screen.....	32
Scan Screen.....	34
Results Screen.....	34
Review Screen.....	36
Tutorial Screen.....	37
Video Viewing Screen.....	38
Settings Screen.....	39
Alpha-Numeric Screen.....	40
Date & Time Screen.....	41
General Preferences Screen.....	42
Savings Preferences Screen.....	43
Self-Test Screen.....	45
ScanPoint® Screen.....	46
Sleep Mode.....	46
Memory Optimization During Power Down.....	47
<b>Measuring Bladder Volume</b> .....	<b>48</b>
Preparing for the Exam.....	48
Measuring Bladder Volume.....	49
Additional Scanning Tips.....	52
Recording a Voice Annotation.....	52
Deleting a Saved Exam.....	54
Printing.....	54
Adding Addition Information.....	54
<b>Histogram of Cost Savings</b> .....	<b>55</b>
<b>Cleaning and Maintenance</b> .....	<b>56</b>
Cleaning and Disinfecting the BladderScan® BVI 9400.....	56
Regular Inspections and Maintenance.....	56
Weekly Inspections.....	57
Using the Built-in Self-Test Utility.....	57
Calibrating the BladderScan® BVI 9400 Using the ScanPoint® System.....	57
Self-Calibration.....	58
Device Repair.....	58

Unit Disposal .....	58
<b>Troubleshooting .....</b>	<b>59</b>
Help Resources .....	59
Icons on the BladderScan® Console .....	60
Diagnosing problems .....	61
Instrument Does Not Turn On .....	61
Printer Problems .....	61
No Paper .....	61
Too Hot .....	62
Clearing a Paper Jam .....	62
<b>Warranty .....</b>	<b>63</b>
Disclaimer of Additional Warranties .....	63
<b>Contacting Verathon® .....</b>	<b>64</b>
<b>Safety and Performance Summary .....</b>	<b>65</b>
<b>Parts and Accessories .....</b>	<b>66</b>
BladderScan® BVI 9400 System Components .....	66
<b>Product Specifications .....</b>	<b>67</b>
Symbol Directory .....	67
Standards and Regulations Compliance .....	68
Electromagnetic Effects .....	68
BladderScan® BVI 9400 Instrument Specifications .....	69
Ultrasound Output Parameters .....	69
Accuracy Specifications .....	70
BladderScan® BVI 9400 Operating Conditions .....	70
BladderScan® BVI 9400 Storage Conditions .....	70
BladderScan® BVI 9400 Displays, Controls, and Indicators .....	71
Instrument Buttons .....	71
Instrument Display .....	73
Battery Charger/Wireless Hub Specifications .....	74
Operating Conditions .....	74
Storage Conditions .....	75
Battery Specifications .....	75
<b>Glossary .....</b>	<b>76</b>

## Table of Figures

Figure 1. BladderScan® BVI 9400 Controls and Indicators .....	18
Figure 2. Battery Charger/Wireless Hub .....	20
Figure 3. Home Screen .....	24
Figure 4. Settings Screen.....	24
Figure 5. Alpha-Numeric Screen.....	25
Figure 6. Facility Name in Display Header.....	25
Figure 7. Set Up Screen - Date and Time.....	26
Figure 8. Date and Time Screen .....	26
Figure 9. Medical Cart, PN: 0800-0322 .....	28
Figure 10. Medical Cart Assembly .....	29
Figure 11. Attaching the BVI 9400 to the Medical Cart.....	30
Figure 12. Home Screen .....	33
Figure 13. Scan Screen .....	34
Figure 14. Results Screen.....	35
Figure 15. Review Screen.....	36
Figure 16. Tutorial Screen.....	37
Figure 17. Video Viewing Screen.....	38
Figure 18. Settings Screen Start Menu.....	39
Figure 19. Alpha-Numeric Screen.....	40
Figure 20. Date & Time Screen .....	41
Figure 21. General Preferences Screen .....	43
Figure 22. Savings Preference Screen .....	44
Figure 23. Self-Test Screen .....	45
Figure 24. ScanPoint® Screens.....	46
Figure 25. Sleep Mode Screen .....	47
Figure 26. Memory Optimization Alert .....	47
Figure 27. Exam Results Printout Using the Onboard Printer .....	54
Figure 28. Calibration Warning .....	58
Figure 29. Printer Out of Paper Screen .....	62

## President's Statement

The team at Verathon® is committed to improving health care delivery by putting healthcare providers and their patients first.

Our products support you, the health care provider, by consistently offering accuracy, utility, reliability and excellence.

Please contact us directly at 1.800.331.2313 (USA and Canada only) or 1.425.867.1348, if we can improve our service to you.

Sincerely,

*Gerald McMorrow*

**Gerald McMorrow, CEO, Founder and Chairman of the Board**



## Important Information

### Product Description

BladderScan® instruments are the gold standard in bladder volume measurement.

The BladderScan® BVI 9400, with patented NeuralHarmonics™ technology, is a portable ultrasound instrument that provides a noninvasive measurement of urinary bladder volume. The device consists of an ultrasound probe that scans the patient's bladder, and a compact, battery-operated console that provides an array of measurement-related information.

BladderScan® is noninvasive and comfortable for the patient. It is accurate, reliable, quick and easy to use. When the user releases the scan button, within seconds, BladderScan® measures ultrasonic reflections on multiple planes inside the body and produces a three-dimensional image. Based on this image, the BladderScan® BVI 9400 calculates and displays the bladder volume. A sonographer is not required.

Patented NeuralHarmonics™ technology (abbreviated from “neural network harmonics”) in the BVI 9400, sharpens accuracy and accelerates speed of measurement. Volume measurements made with NeuralHarmonics™ technology are more accurate than those from conventional two-dimensional ultrasound, as they are based on a more complex, multifaceted image of the bladder. This technology, applying multi-spectral analysis to a robust data set, helps reduce margin of error and minimize uncertainty in essential measurements of bladder function.

BladderScan® BVI 9400 measurements can be printed via an onboard printer or transmitted, using HIPAA-compliant ScanPoint® with QuickPrint Imaging Technology Software (optional), to your office or facility computer for viewing, printing, or archiving.

### Intended Use Warnings and Cautions

The BladderScan® BVI 9400 should be used only by individuals who have been trained and authorized by a physician or the institution providing patient care. All users must read this entire *User's Manual* prior to using the BladderScan® BVI 9400. Do not attempt to operate this instrument until you thoroughly understand all instructions and procedures in this manual. Failure to comply with these instructions may compromise the performance of the device and the reliability of its measurements. For the most current version of the *User's Manual*, please visit the Verathon® Web site at: <http://www.verathon.com>, then select the BladderScan® > Customer Support links to open a link to this manual and other training materials.

#### Biological Safety

To date, exposure to pulsed diagnostic ultrasound has not been shown to produce adverse effects. However, ultrasound should be used only by medical professionals when clinically indicated, using the lowest possible exposure times indicated by clinical need.

The ultrasound output power of the BladderScan® BVI 9400 is not user adjustable and is limited to the minimum level necessary for effective performance. Data on acoustic output levels can be found in the “Technical Description” section of this manual.

**Statement of Prescription**

United States federal law restricts the BladderScan® BVI 9400 to use by, or on the order of, a physician. This statement is required per 21 Code of Federal Regulations (CFR) 801.109.

**NOTE:**

It is standard practice to have medical staff authorize the use of the BladderScan® BVI 9400 within its intended use throughout an institution. Individual prescriptions for use are not required.

**Statement of Intended Use**

The BladderScan® BVI 9400 projects ultrasound energy through the lower abdomen of the patient to obtain an image of the bladder which is used to calculate bladder volume noninvasively.

**Contraindications (U. S. Only)**

The BladderScan® BVI 9400 is not intended for fetal use or for use on pregnant patients.

To assure safe and reliable operation for the use and the patient, please read and heed the following warnings and cautions.

**WARNING! Risk of explosion.**

If you use the BladderScan® BVI 9400 in the presence of flammable anesthetics, the hazard of potential explosion exists.

**WARNING! Risk of explosion, fire, or serious injury.**

The BladderScan® BVI 9400 is provided with two Lithium Ion batteries. Never short circuit the battery pack by either accidentally or intentionally bringing the battery terminals into contact with any other conductive object. This could cause serious injury or fire and could also damage the battery pack and the BladderScan® device.

**WARNING! Risk of explosion, fire, or serious injury.**

Never expose the battery pack to abnormal shock, vibration, or pressure. The main battery pack's internal protective covering could fail, causing it to overheat or ignite, resulting in caustic liquid leakage, or explosion or fire, possibly resulting in serious injury.

**WARNING! Potential patient hazard.**

To date, exposure to low-power, pulsed diagnostic ultrasound has not been shown to produce adverse effects. However, medical professionals should use ultrasound only when clinically indicated, using the lowest exposure times possible to obtain accurate measurements. The ultrasonic output of the BladderScan® BVI 9400 is not user-adjustable and is limited to the minimum level necessary for effective performance. For more information about the acoustic output levels of this device, please refer to the section in this manual titled *BladderScan® BVI 9400 Instrument Specifications* on page 69.

**CAUTION: Risk of inaccurate measurements/results.**

When using the BladderScan® BVI 9400 be aware of the following conditions which can affect ultrasound transmission and decrease the accuracy of exam results.

- ◆ Use care when scanning patients who have had supra-pubic or pelvic surgery. Scar tissue, surgical incisions, sutures, and staples can affect ultrasound transmission and accuracy.

- ◆ Do not use the BladderScan® BVI 9400 on a patient with open skin or wounds in the suprapubic region.
- ◆ Do not use the BladderScan® BVI 9400 on a patient with ascites.
- ◆ If you scan a patient with a catheter in his/her bladder, the catheter may affect measurement accuracy. However, the information obtained from the measurement could still be clinically useful for detecting problems such as a blocked catheter.

**CAUTION:** Observe the following precautions in the safe use and care of the BladderScan® BVI 9400.

**Hazardous materials present. Assure proper disposal.**

The BladderScan® BVI 9400 and related devices may contain lead, mineral oils, batteries, and other environmentally hazardous materials. When the BladderScan® BVI 9400 has reached the end of its useful service life, return the device, charging cradle, and related accessories to a Verathon® Service Center for proper disposal. Alternatively, follow your local protocols for hazardous waste disposal.

**Assure proper computer system configuration.**

When using the BladderScan® BVI 9400 with optional ScanPoint® software, your computer must be minimally certified to EN / IEC / CSA / UL 60950 or 60101-1 standards. This configuration ensures that compliance to the EN/IEC 60601-1-1 system standard is maintained. Anyone connecting additional equipment to the BladderScan® BVI 9400 signal input port or signal output port configures a medical system, and is therefore responsible for ensuring that the system complies with EN/IEC 60601-1-1. If you need assistance, contact your biomedical staff, Verathon Medical® representative, or the Verathon Medical® Customer Care Department at 1.800.331.2313.

**Assure proper distance from patient.**

When transmitting data to or from your computer, make sure that the BladderScan® BVI 9400, accessories, and computer are outside the patient vicinity (more than six feet (2 meters) from the patient). Refer to UL 2601-1 Clause 2 deviation for the definition of patient vicinity.

**Bluetooth® Wireless Technology**

The *Bluetooth* technology used in the BladderScan® BVI 9400 is compliant with:

- ◆ *Bluetooth* Specification as defined and approved by The Bluetooth Special Interests Group.
- ◆ Logo certification with *Bluetooth* wireless technology as defined by The *Bluetooth* Special Interest Group.

**CAUTION:** *Bluetooth* and Wireless LAN devices operate within the same radio frequency range and may interfere with one another. If you are using the BladderScan® BVI 9400 *Bluetooth* link and Wireless LAN devices simultaneously, you may experience less than optimal network performance or even lose your network connection. If this happens, you may need to move the BladderScan® and ScanPoint® host computer to an area away from the 2.4 GHz wireless LAN devices (40 meters/44 yards, or more).

## Introducing the BladderScan® BVI 9400

### Product Description

BladderScan® instruments are the gold standard in bladder volume measurement.

The BladderScan® BVI 9400, with patented NeuralHarmonics™ technology, is a portable ultrasound instrument that provides a noninvasive measurement of urinary bladder volume. The device consists of an ultrasound probe that scans the patient's bladder, and a compact, battery-operated console that provides an array of measurement-related information.

BladderScan® is noninvasive and comfortable for the patient. It is accurate, reliable, quick and easy to use. When the user releases the scan button, within seconds, BladderScan® measures ultrasonic reflections on multiple planes inside the body and produces a three-dimensional image. Based on this image, the BladderScan® BVI 9400 calculates and displays the bladder volume. A sonographer is not required.

Patented NeuralHarmonics™ technology (abbreviated from “neural network harmonics”) in the BVI 9400, sharpens accuracy and accelerates speed of measurement. Volume measurements made with NeuralHarmonics™ technology are more accurate than those from conventional two-dimensional ultrasound, as they are based on a more complex, multifaceted image of the bladder. This technology, applying multi-spectral analysis to a robust data set, helps reduce margin of error and minimize uncertainty in essential measurements of bladder function.

BladderScan® BVI 9400 measurements can be printed via an onboard printer or transmitted using HIPAA-compliant ScanPoint® technology for storage and archiving on Verathon® servers. Stored exams can be accessed at any time from your office's computer for viewing or printing. **(NOTE: Use of ScanPoint® software is optional.)**

If needed, after a scan has been taken, a unique aiming icon guides the operator to optimal probe placement with a comprehensive, three-dimensional display showing the bladder in two cross-sectional images verifying that a complete scan has been achieved. Bladder volume, patient type, directional aiming with real-time feedback, battery status, and usage rate indicators are all displayed on the device's LCD screen. The BladderScan® BVI 9400 contains an on-board thermal printer that allows the user to print exam results quickly with the press of a button.

A Calibration Targeting System, consisting of a spiral-shaped calibration target along with a purpose-designed calibration container, allows the user to easily calibrate the device by scanning a known target.

Optionally, exam results may be transmitted to a personal computer running ScanPoint® with QuickPrint software via a proprietary wireless connection. ScanPoint® with QuickPrint allows the user to archive data, calibrate the device, update software, print, and transfer data through a Web-based interface.

The BladderScan® BVI 9400 system also includes a universal battery charger for the custom, user-replaceable Lithium Ion battery incorporated in the system.

The BladderScan® BVI 9400 may be mounted on a purpose-designed cart which holds the instrument securely and provides a holder for ultrasound gel and other accessories.

The BladderScan® BVI 9400 is designed for simple, intuitive operation. However, to ensure safe and effective operation, before using the device:

- ◆ Familiarize yourself with the contents of this manual.
- ◆ Watch the training video provided on the instrument.

## BladderScan® Parts and Features

The BladderScan® BVI 9400 has two main components: The Console and the Probe. The Console and Probe are linked by a detachable cable. The BladderScan® BVI 9400 controls and indicators are illustrated in Figure 1.

Figure 1. BladderScan® BVI 9400 Controls and Indicators

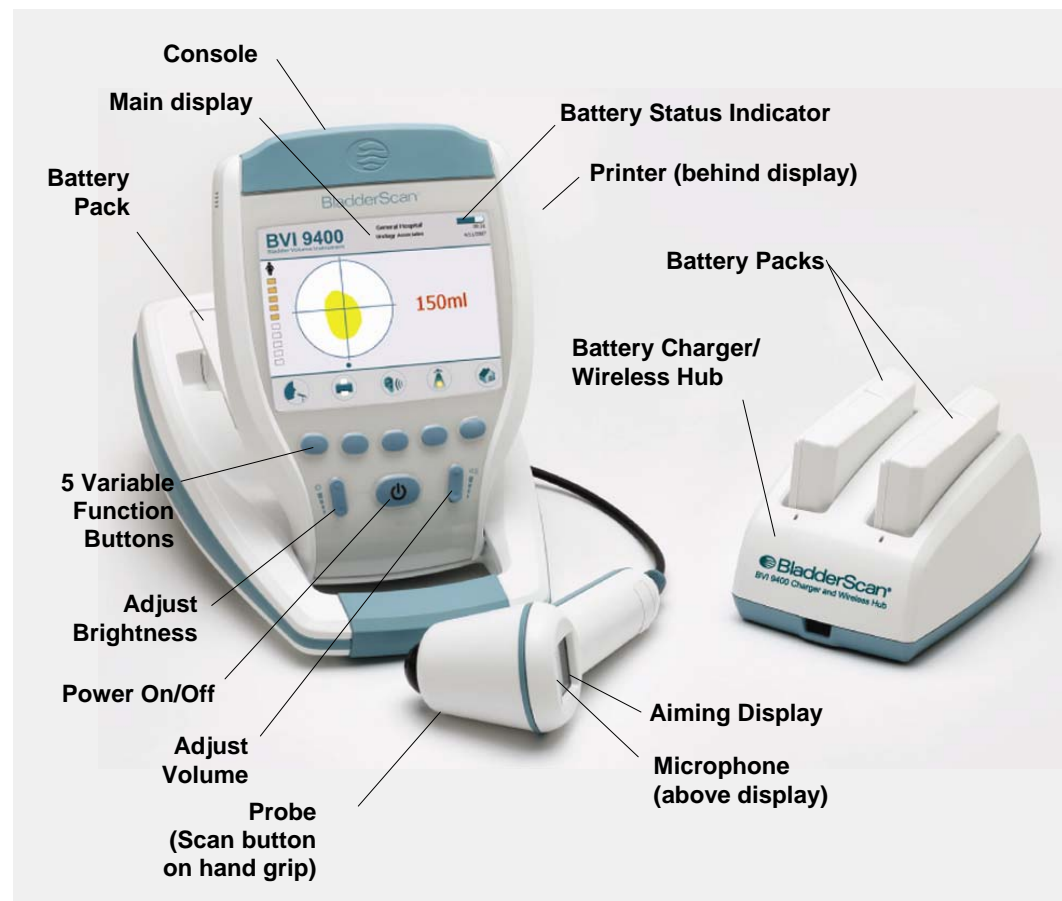



### Probe Components

The Probe transmits and receives ultrasound waves, automatically moving its internal transducer 360° to scan twelve different planes to produce a three-dimensional image of the bladder. The Probe is attached to the Console by a cable. The Probe has three main features:

Part Name	Purpose
<b>SCAN button</b>	Press to take a scan.
<b>Aiming Display</b>	The LCD displays directional arrows to assure that the bladder is centered within the scanning cone.
<b>Microphone</b>	Records voice annotations.

### Console Components

The Console provides all operating controls for the scanning process by means of five variable function buttons. The measured bladder volume and target-shaped aiming icons are clearly displayed on the LCD screen. The Console also provides controls for adjusting brightness and volume, turning the power on/off, interfacing with a ScanPoint® host computer (optional), and adjusting user settings and preferences. The Console also houses the Battery and the Printer. The Console's controls and features are described in the following table:

Part Name	Purpose
<b>Main Display</b>	Displays the bladder volume measurement, patient type, settings, and instrument status.
<b>Power on/off</b>	Toggles main power on/off
<b>Volume</b>	Press to adjust volume up/down on voice annotation playback, start up sound, and "scan complete" tone.
<b>Brightness</b>	Press to adjust display brightness dimmer/brighter.
<b>5 Variable Function Buttons</b>	Depending on device mode, the buttons provide access to all instrument functions for scanning, recording annotations, printing, connecting to ScanPoint® (optional), accessing the training video, and setting user preferences.
<b>Printer / Printer Door</b>	Press to release the Printer door.

## Battery Charger/Wireless Hub

The BladderScan® BVI 9400 is powered by a Lithium Ion (Li-Ion) battery pack. The battery charger provided with your BVI 9400 can charge two Li-Ion battery packs while simultaneously functioning as the wireless hub linking your BVI 9400 to the ScanPoint® host computer.

**NOTE:** Use of ScanPoint® with QuickPrint software is optional.

- ♦ To provide power to the battery packs, the Battery Charger/Wireless Hub must be plugged into a wall outlet using the power cord provided.
- ♦ To provide wireless communication between the BVI 9400 and the ScanPoint® host computer, plug the Battery Charger/Wireless Hub USB connector into a USB port on the ScanPoint® host computer.

The Battery Charger/Wireless Hub maintains an operating distance of up to 120 feet (36 meters) between the ScanPoint® computer and the BVI 9400, regardless of barriers such as walls, ceilings, or windows.

**Figure 2. Battery Charger/Wireless Hub**

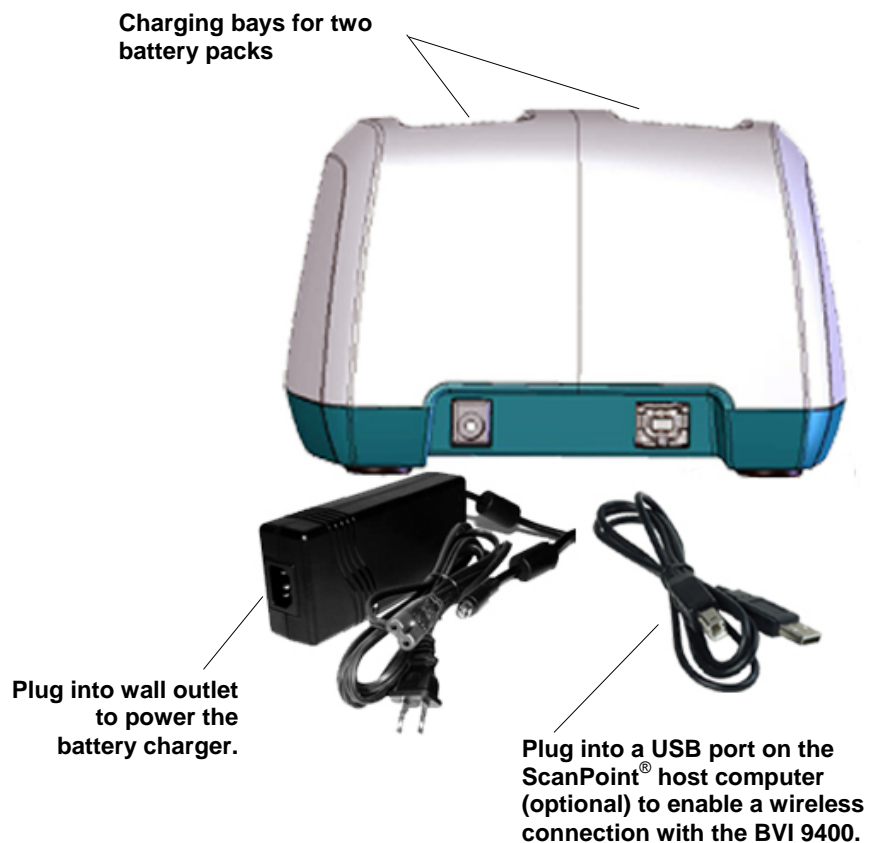

## Parts and Accessories

Part Number	Description
0570-0190	BVI 9400 Instrument - Console
0570-0188	BVI 9400 Instrument - Probe
0570-0193	Battery Charger/Wireless Hub
0570-0066	Lithium Ion Battery (2 provided)
0900-1606	BVI 9400 User's Manual (on In-Service CD)
0900-1601	ScanPoint® with QuickPrint User's Manual (on In-Service CD)
0900-1446	Quick Reference Card - Demo/Use
0900-1447	Quick Reference Card - Calibration
0800-0319	Thermal Paper Roll for the Printer
0900-1500	BladderScan® BVI 9400 In-Service CD (Includes User's Manuals, Video Tutorial, and Quick Reference Cards)
0800-0322	Mobile Cart (optional)
0900-1238	ScanPoint® with QuickPrint Software Install CD. <b>NOTE:</b> Use of the ScanPoint® software is optional and not required for operation of the BVI 9400.
0620-0340	Calibration Kit (Optional - Requires ScanPoint® with QuickPrint software. Includes Calibration Container, Calibration Target, etc.)
0800-0225	Sontac® Gel Pads, QTY 50
0800-0005	Acoustic Coupling Gel, 0.25 liter (case of 12)

## Getting Started

The previous section provided basic information about the BVI 9400 parts and features. This section provides instructions for setting up your BVI 9400 prior to first use.

To help you get up and running as quickly as possible, the next few pages explain how to:

- ◆ Unpack the BladderScan® BVI 9400 and related accessories
- ◆ Charge and install the batteries
- ◆ Customize the display (enter your institution's name, date, time, and other user data)
- ◆ Assemble the mobile cart (optional)
- ◆ Install the ScanPoint® with QuickPrint software (optional)

### Unpack the Box and Check the Components

Set the shipping container right side up and carefully open the top flaps (do not insert anything sharp through the top of the box). Remove the contents and verify that you have received everything listed below. If anything is missing or damaged, notify your authorized Verathon Medical® representative or Verathon Medical® Customer Care Department at 1.800.331.2313.

- (1) BladderScan® BVI 9400 (Console and Probe)
- (1) Medical Cart (optional)
- (2) Rechargeable Lithium Ion batteries
- (1) Battery Charger/Wireless Hub
- (1) In Service CD (includes User Manuals, Video Tutorial, and Quick Reference Cards)
- (1) Training Pack

### Charge the Batteries

Two Lithium Ion batteries are included with the BladderScan® BVI 9400. One battery can be recharged in the Battery Charger/Wireless Hub while the other is installed in the BladderScan® instrument. This ensures that there is no instrument downtime. The charger will bring the batteries to a full charge within 6 hours or less.

**NOTE:** Before using the BladderScan® BVI 9400 for the first time, you will need to charge both batteries prior to first use.

**To charge the batteries:**

1. Plug the Battery Charger/Wireless Hub unit in to a standard wall outlet.
2. Remove the label covering the battery contacts and insert the battery into the recess in the battery charger

**NOTE:** Fully charging the battery may take up to 6 hours.

Batteries may be stored in the charger. There is no danger of overcharging the batteries.

3. Check the colored indicator lights on the battery charger to determine battery status:
  - ♦ **Solid green:** Battery fully charged.
  - ♦ **Amber:** Battery charging.

**Install a Battery Pack in the Console****WARNING! Risk of serious injury.**

If the battery pack is leaking or its case is cracked, put on protective gloves to handle it and discard it immediately. Always dispose of used battery packs in compliance with all applicable laws and regulations. Put insulating tape, such as cellophane tape, on the electrodes during transportation to avoid a possible short circuit, fire, or electrical shock. Failure to do so could result in serious injury.

**To insert a battery pack:**

Insert the charged battery into the battery well in the Console, slide it under the ledge and push down gently until the battery clicks into place.

**NOTE:** The battery pack is designed to prevent incorrect installation.

**NOTE:** If the battery pack does not slide into the battery well easily, move the battery and try again. Do not force the battery into position.

**Battery Care**

The BladderScan® BVI 9400 draws very little power when it is turned off. However, if you do not plan to use the BladderScan® for several weeks, you should remove the battery to prevent it from discharging.

When batteries are not in use, they should be stored in the Battery Charger so they remain fully charged.



## Enter the Clinic Name

You can customize your BladderScan® 9400 by entering your facility's name and current date and time. This information will subsequently be included on BladderScan® displays and all printouts of exam results.

**NOTE: Use of extended-Latin and/or non-Latin characters:** The following instructions explain how to enter a facility name that uses only standard Latin characters. Extended Latin characters (tilde, umlaut, accents, circumflex, etc.) and/or non-Latin characters can be entered only by using ScanPoint® with QuickPrint software. To enter a name that uses extended or non-Latin characters, please refer to the instructions in the ScanPoint® with QuickPrint User's Manual.

### To enter your clinic's name:





1. Turn the BladderScan® BVI 9400 on by pressing the POWER button  on top of the Console.
2. When the Home screen appears (Figure 3), press the SETTINGS button  to open the Settings screen.
3. On the Settings screen (Figure 4), push either the  or  button until **Name** is highlighted (red). Press the  button to open the Alpha-Numeric screen.

Figure 3. Home Screen

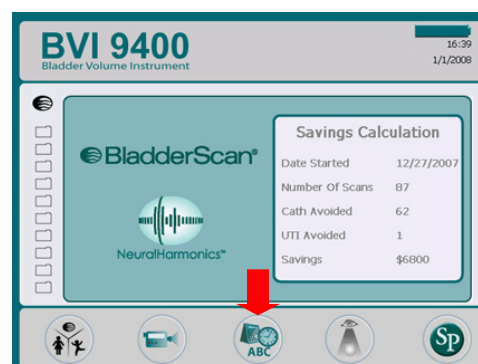
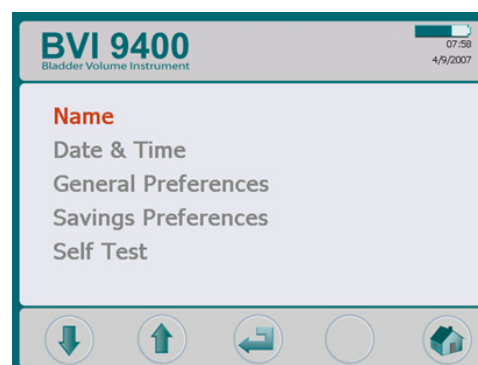

Figure 4. Settings Screen





4. On the Alpha-Numeric screen (Figure 5), use the → and ↓ buttons to move to the desired character. When the desired character is highlighted (red), press the + button to add it to your text. Use the -- button to delete characters.
  - ◆ To add a space between words, press the blank space below the letter "x".
  - ◆ To add a second line of text use the ¶ character.
5. Continue to select and add characters as needed.
6. When finished, press the SETTINGS button  to return to the Settings screen. From the Settings screen, press the HOME button  to return to the Home screen. The facility name will now appear in the display header (Figure 6).

Figure 5. Alpha-Numeric Screen

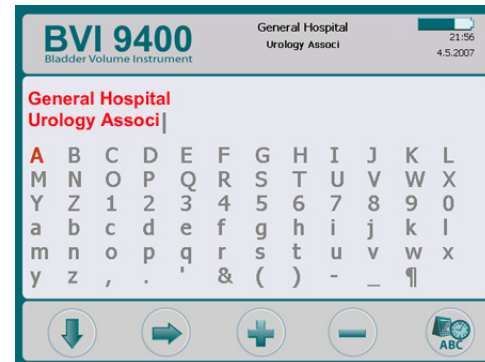
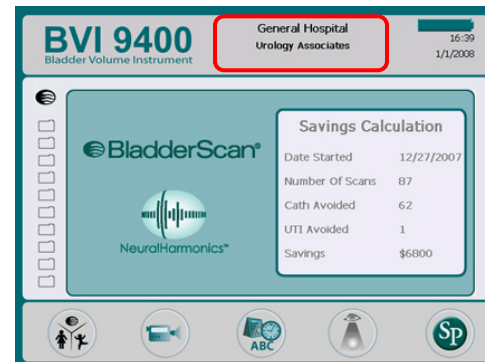









Figure 6. Facility Name in Display Header



## Set the Date and Time

The clock has its own Lithium battery and maintains the correct date and time for at least ten years.

### To set the date and time:

1. If the BladderScan® instrument is turned off, turn the power on by pressing the  button on the front of the Console.
2. From the Home screen (Figure 3), press the SETTINGS button  to open the Settings screen.
3. On the Settings screen, push either the  or  arrow until **Date & Time** is highlighted (red) (Figure 7). Press the  button to open the Time & Date screen.
4. On the Date & Time screen (Figure 8), use the  and  buttons to move to the desired unit (hours, minutes, month, day, year).

When the desired unit is highlighted (red),





- ♦ Press the  button to increase values.
  - ♦ Press the  button to decrease values.
5. When the time and date are set correctly, press the SETTINGS button  to return to the Settings screen. From the Settings screen, push the HOME button  to return to the Home screen.

Figure 7. Set Up Screen - Date and Time

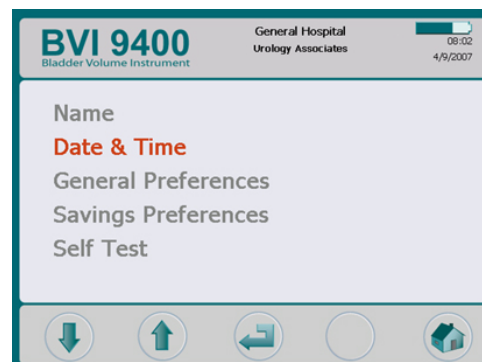
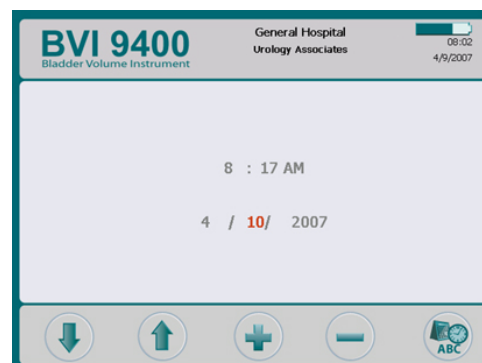

Figure 8. Date and Time Screen



### Setting General Preferences and Savings Preferences

**NOTE:** See page 42 for information about setting General Preferences, Savings Preferences, and Self-Test Options.

General Preferences, Savings Preferences, and Self-Test Options can be accessed from the Settings screen.

General preferences include options for: Language, Date Format, Time Format, Time Zone, and Calibration Warning.

Savings Preferences include: UTI Rate, UTI Cost, Catheterization Cost, Catheterization Volume, Currency, and Savings Calculation.

### Load a Roll of Thermal Paper

To load a new roll of thermal paper:

1. Open the paper compartment door (located on the base of the Console, under the display).
2. Slide the door to the right, then lift the printer door up.
3. Insert the end of a new paper roll with the thermal side down, into the paper slot.

To verify which side is the thermal side, scratch the paper with your finger nail. If a black mark appears, this is the thermal side.

4. Extend the end of the paper past the end of the unit.
5. Rotate the printer door down. Make sure you hear it snap into place.
6. Slide the printer door to the left.
7. Tear the excess paper off.

**CAUTION!** To avoid paper jams, never fold the end of the paper roll or cut it diagonally or to a point.

**NOTE:** If the paper appears to be stuck in the printer, contact your authorized BladderScan® Service Center, your local BladderScan® distributor, or Verathon Medical® Customer Care at 1.800.331.2313 for service.

## Assemble the Medical Cart

**NOTE:** If you're not using the medical cart, please skip to the next section, Install the ScanPoint® with QuickPrint Software, on page 30.

The optional Medical Cart is illustrated in Figure 9.

**Figure 9. Medical Cart, PN: 0800-0322**



### Medical Cart Parts List

Item No.	Quantity	Part Number	Description
1	1	0142-0276	Tray Assembly
2	1	0810-0140	Bracket and Post
3	1	0810-0141	Medical Cart Base
4	4	0261-0107	Screw PH W Lock 25-20 x 1/2
5	1	0260-0357	Fluted Knob 3/8-16 x 1.00
6	4	0810-0142	Caster, 3 inch
7	1	0810-0143	Caster, 3 inch with Brake

**To assemble the cart:**

While following the assemble procedure, refer to **Figure 10**.

1. Align and press one 3-inch Caster with Brake (Item 7) and four 3-inch Casters (Item 6) into Medical Cart Base (Item 3).
2. Align through round hole in Bracket and Post (Item 2) bracket to through hole in Medical Tray (Item 1).
3. Insert Bracket and Post (Item 2) into square relief in bottom of Medical Tray Assembly (Item 1).
4. Insert four Screws (Item 4) through Bracket and Post (Item 2) into molded inserts in Medical Tray (Item 1); tighten securely.
5. Place Medical Tray Assembly with Bracket and Post into Medical Cart Base (Item 3).
6. Place device in foot prints on Medical Tray (Item 1).
7. Screw the Fluted Knob (Item 5) through Bracket and Post (Item 2) bracket round hole and hand tighten.

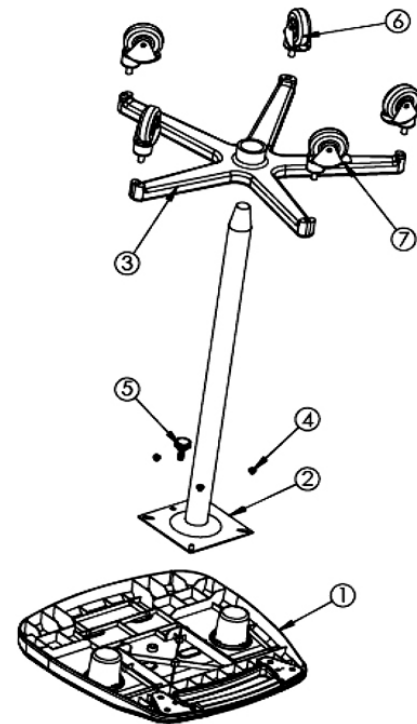

**Figure 10. Medical Cart Assembly**

To attach the BVI 9400 to the Medical Cart, refer to the instructions on page 30.

## Install the BladderScan® on the Optional Mobile Cart

Your BladderScan® BVI 9400 is completely portable and can be easily moved and positioned for convenient use. Installing the BVI 9400 on the optional mobile cart will allow you to move the BladderScan® along with related accessories (spare battery, Sontac® Gel Pads or ultrasound gel, and an extra roll of paper) to the patient examining area or bedside as necessary.

### To install the BladderScan® BVI 9400 on the Mobile Cart:

**NOTE:** For cart assembly instructions and parts list, refer to page 28.

To install the BVI 9400 to the Medical Cart, screw the Fluted Knob (Item 5) through Bracket and Post (Item 2) bracket round hole and Tray Assembly (Item 1), and into the mounting hole on the bottom of the device. Hand tighten (Figure 11).



**Figure 11. Attaching the BVI 9400 to the Medical Cart**

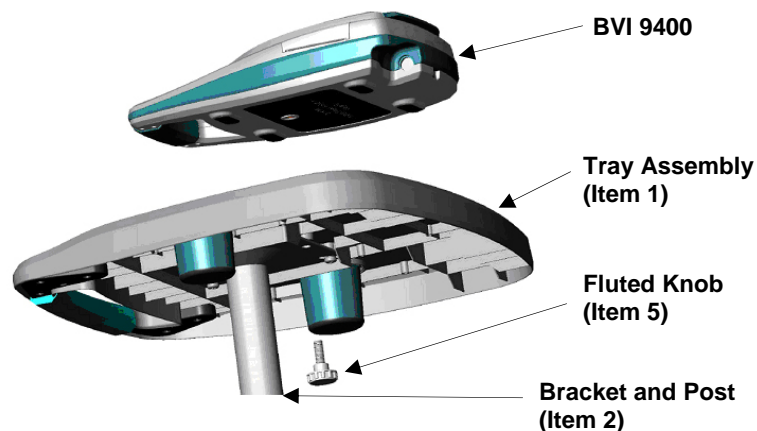

## Install the ScanPoint® with QuickPrint Software (Optional)

Optional ScanPoint® with QuickPrint software is designed to mesh seamlessly with your BladderScan® devices. The BVI 9400 automatically downloads exam data to the ScanPoint® host computer via a wireless connection enabled by the Battery Charger/Wireless Hub - allowing further viewing, analysis, archiving, and report generation.

To install ScanPoint® with QuickPrint, insert the ScanPoint® with QuickPrint Install CD into your computer's CD drive and follow the on-screen prompts. Please refer to the



separate User's Manual provided with ScanPoint® with QuickPrint for complete installation and operating instructions.

## Watch the Training Video

The training video provides an overview of how to perform an ultrasound scan of the bladder using the BladderScan® BVI 9400. The video is approximately 5 minutes long.

- ◆ The training video is available at the Verathon® Web site:  
<http://www.verathon.com/Training%20Videos.htm>.
- ◆ A training tutorial is available for review anytime on the BladderScan® BVI 9400 by pushing the  button from the Home screen.

## Displays, Controls, and Indicators

### Console Displays and Button Functions

The Console LCD display presents user information and prompts that vary depending on the current device function.

The five buttons below the display have variable functions according to device mode. Button functions are indicated by icons in the display footer, immediately above each button.

The following tables illustrate and describe the BladderScan® BVI 9400 displays and button functions:

#### Home Screen

The Home screen (Figure 12, page 33) appears when the BladderScan® is first powered on.

The Home screen serves as a starting point for all of the main functions of the BladderScan®. The Home screen displays:

- ◆ A list of saved exam results (10 maximum) saved in chronological order. Yellow folders hold saved exams. Grey folders represent empty spaces still available for saving exam results.
- ◆ A battery status indicator.



Indicates a fully charged battery.



Indicates a battery 50% to 75% charged.



Indicates a battery 25% to 50% charged.



Indicates a battery that is nearly discharged and can power only a few more scans.



Indicates the battery must be changed.

Figure 12. Home Screen

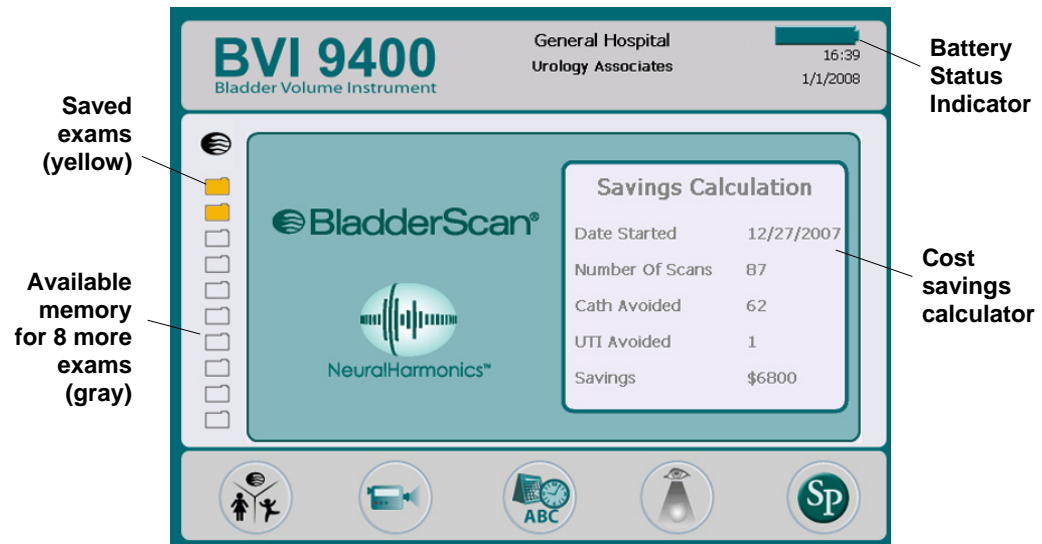

### Home Screen Buttons

Button	Function
	<p>Single button with three modes. When performing an exam, press the button repeatedly until the desired setting appears above the saved exams folders:</p> <ul style="list-style-type: none"> <li>◆ Select the "small child" icon to scan a patient with height less than 48 inches (122 cm) tall and weight less than 60 lbs (27 kg).</li> <li>◆ Select the "female icon" to scan a female patient who has not had a hysterectomy.</li> <li>◆ Select the "BladderScan® icon" to scan all other patients.</li> </ul>
	Press to view the training video.
	Go to the Settings screen (set the time, date, institution name, and user preferences).
	Press to review a previously saved exam.

Button	Function
	Press to initiate communication with the ScanPoint® host computer. Saved and annotated exams will be automatically uploaded to the host computer. (ScanPoint® software must be previously installed and the computer connected to the wireless hub. Use of the ScanPoint® software is optional.)

### Scan Screen

The Scan screen (Figure 13) appears after you press the SCAN button on the probe and displays a progressively updating image of the bladder outline. When the ultrasound measurement is complete, the Results screen opens automatically.

The five buttons below the display do not function during the scan.

Figure 13. Scan Screen

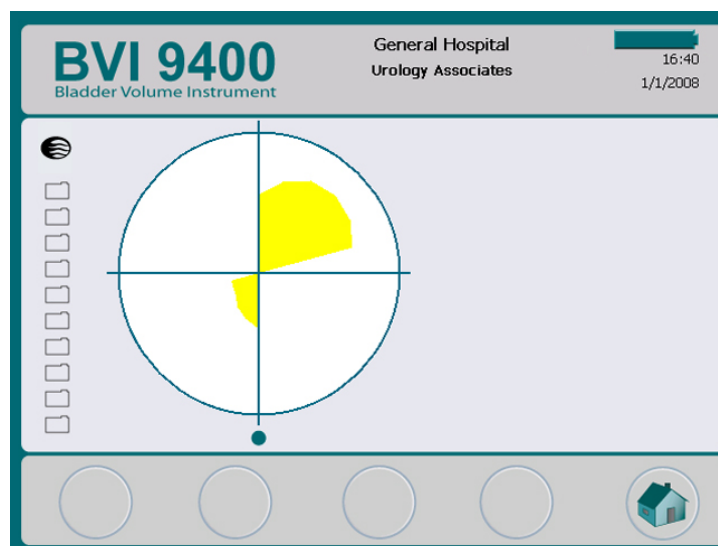

### Results Screen



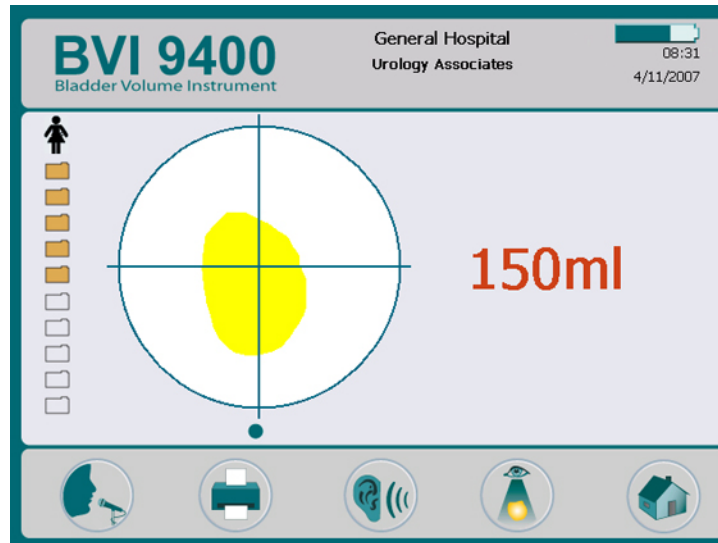

The Results screen (Figure 14) appears automatically when an ultrasound scan is complete.

The display presents the result of the exam: crosshairs, bladder outline, and the calculated bladder volume. You may choose to print this result to the onboard printer and/or to record a voice annotation to save the exam. After the annotation is recorded, the PLAY and REVIEW buttons become active and the newly recorded exam appears on the main display as a yellow folder icon.

Figure 14. Results Screen



#### Results Screen Buttons

Button	Function
	Press to record a voice annotation (up to 10 seconds long).
	Press to print exam results to the onboard label printer.
	Press to play a previously recorded voice annotation. If no voice annotations are recorded, this button is disabled.
	Press to go to the review screen. If no voice annotations are recorded, this button is disabled.
	Press to return to the Home screen.

**Review Screen**



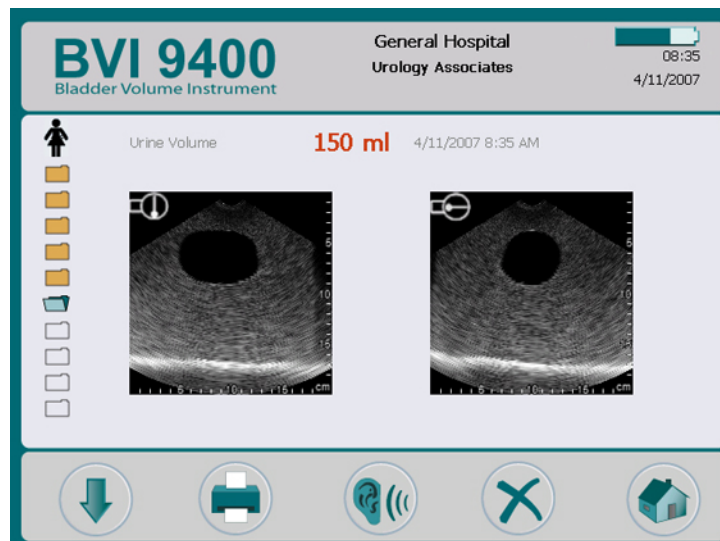

The Review screen (Figure 15) opens when you select a saved exam (yellow folder icon) to review.

The displays shows the ultrasound images associated with the selected exam. A green open-folder icon indicates which exam is being viewed. While reviewing saved exams, the buttons below the display allow you to print, replay, or delete exam data.

**Figure 15. Review Screen**





**Review Screen Buttons**

Button	Function
	SELECT. Press to select the next exam in the list.
	PRINT. Press to print the results for the currently selected exam to the onboard label printer. While printing is in progress a flashing print icon appears on the display. The buttons are disabled except SELECT and PLAY.
	PLAY. Press to play a previously recorded voice annotation. If no voice annotations are recorded, this button is disabled.
	DELETE. Press to delete the currently selected exam.
	HOME. Press to return to the Home screen.

### Tutorial Screen

To open the Tutorial Screen (Figure 16) press the  button from the Home screen (Figure 12, page 33).



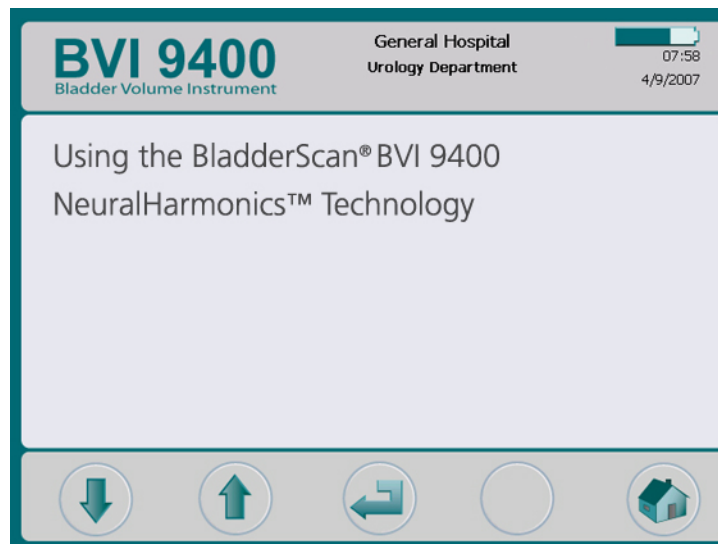

The Tutorial screen presents a menu of training modules. To select a title, press either the  or  button until the desired title is highlighted (red). Press the  button to go to the Video Viewing screen.

**NOTE:** The SCAN button (on the Probe) is disabled during module playback.

Figure 16. Tutorial Screen



### Tutorial Screen Buttons

Button	Function
	SELECT NEXT: Press to move down one title or to skip back one chapter in the training module
	SELECT PREVIOUS: Press to move up one title or to skip forward one module.
	ENTER: Press to begin module playback. While the module is playing, press to pause. Press again to resume play.
-	No function.
	HOME: Press to return to the Home screen.



### Video Viewing Screen



The Video Viewing (Figure 17) screen is activated by pushing the ► button on the Tutorial screen (Figure 16).

**NOTE:** The SCAN button is disabled during video playback.

Figure 17. Video Viewing Screen



### Video Viewing Screen Buttons

Button	Function
-	No function.
	PLAY/PAUSE: Press to start video playback. Press to pause. Press again to resume play.
	BACK: Return to the training titles screen.
-	No function.
	HOME: Press to return to the Home screen.

## Settings Screen

To open the Settings screen (Figure 18), push the SETTINGS button  on the Home screen.





The display presents a list of user-configurable settings: Name, Time & Date, General Preferences, Savings Preferences, and Self-Test. Use the Up/Down arrows to move through the list of setup options. To select an option, press the U-turn arrow.

**NOTE:** When the Settings screens are open, the SCAN button (on the Probe) is disabled.

Figure 18. Settings Screen Start Menu



### Settings Screen Buttons

Button	Function
	SELECT NEXT: Press to select the next setting in the list.
	SELECT PREVIOUS: Press to select the previous setting in the list.
	ENTER: Press to select the highlighted setting.
-	No function.
	HOME: Press to return to the Home screen.



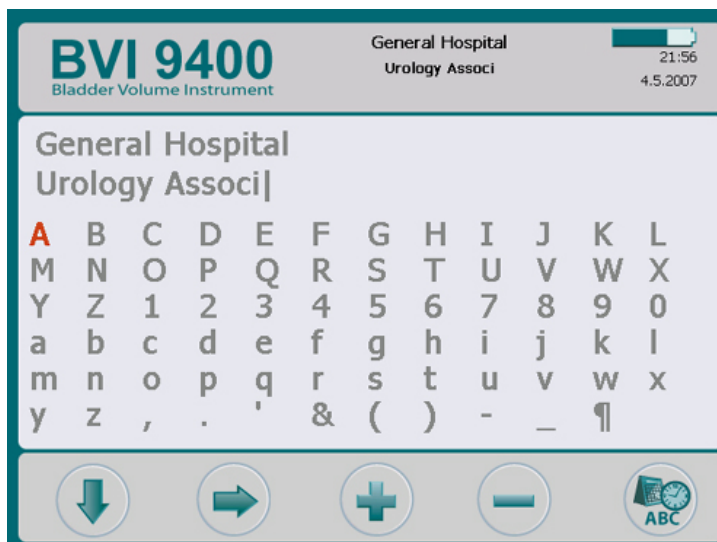

### Alpha-Numeric Screen

This screen allows you to select the appropriate alpha-numeric characters for entering your health care institution's name.

Figure 19. Alpha-Numeric Screen



### Alpha-Numeric Screen Buttons

Button	Function
	Press to move down in the grid.
	Press to move to the right in the grid.
	Press to add the highlighted character to the name.
	Press to delete one character from the name.
	Press to return to the Setup screen.

### Date & Time Screen

This screen allows you to adjust the date and time.

**NOTE:** If the time display is set to show a 24-hour clock, the hour units are 0 - 23. If the clock is set to show a 12-hour clock, the hour units are 1 AM - 12 AM and 1 PM - 12 PM.

Referring to the example shown in Figure 20:

#### **To change the time from 8:17 AM to 11:30 AM:**

1. Press the **↓** button until the **8** is highlighted.
2. Press the **+** button 3 times until the time digits display **11:17 AM**. (Alternatively, press and hold the **+** button to move more rapidly through the digits.)
3. Press the **↓** button until the **17** is highlighted.
4. Press the **+** button repeatedly until the minutes display **30**. (Alternatively, press and hold the **+** button to move more rapidly through the digits.)

The time setting is now 11:30 AM.







5. Press the SETTINGS button  to save this entry and return to the Setup screen.

Figure 20. Date & Time Screen

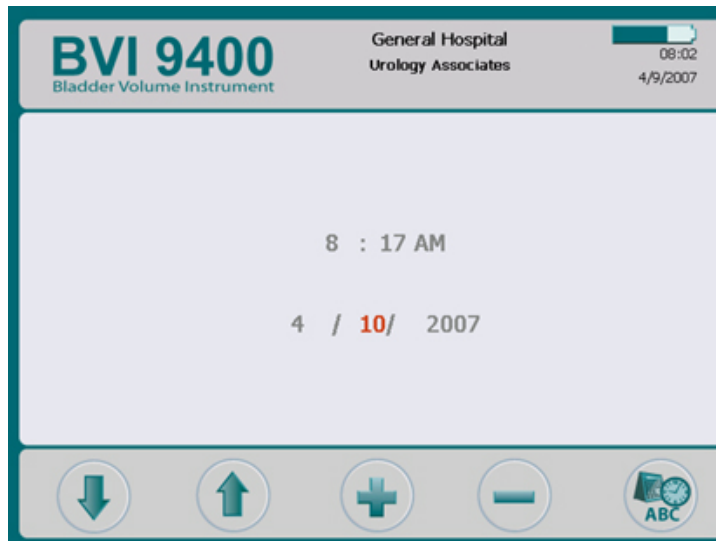

**Date & Time Screen Buttons**

Button	Function
	Move back one changeable unit.
	Press to move forward to the next changeable unit (in this case, hours, minutes, AM/PM, month, day, year).
	Press to add and/or toggle digits as appropriate (hours, minutes, AM/PM, months, day, years). Press and hold the button to move through options more quickly.
	Press to subtract or toggle digits as appropriate (same as above). Press and hold the button to move through options more quickly.
	Press to save the current date/time setting and return to the Setup screen.

**General Preferences Screen**

This screen displays a list of available settings and their current values.

Available settings:



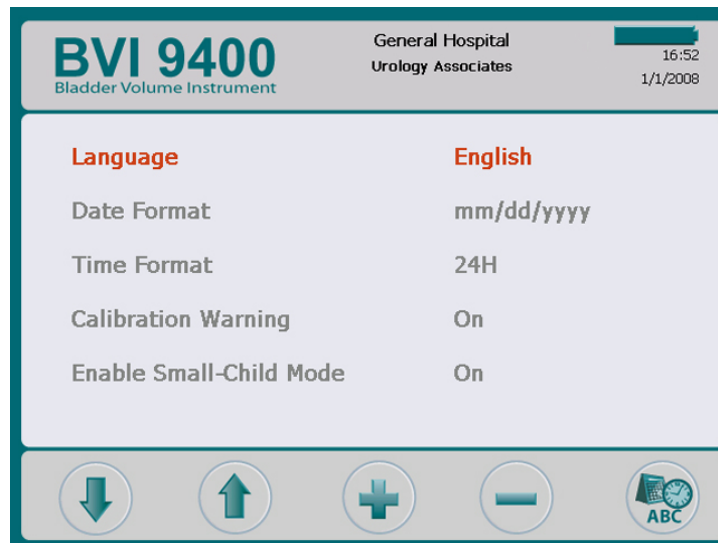

- ♦ **Language:** English (default), Chinese Traditional, Czech, Danish, Dutch, Finnish, French, German, Greek, Italian, Hungarian, Japanese, Korean, Norwegian, Portuguese (European), Spanish, Swedish, Turkish.
- ♦ **Date Format:** mm/dd/yyyy; dd.mm.yyyy; yyyy-mm-dd.
- ♦ **Time Format:** 12-hour or 24-hour
- ♦ **Calibration Warning:** On (default), Off. When “On” is selected, a calibration warning will appear in the display header when the device requires calibration.
- ♦ **Enable Small Child Mode (SCM):** On (default), Off. Select “Off” to disable Small Child Mode.

**NOTE:** If use of the small child mode is rare in your practice, you may want to turn that option off.

Figure 21. General Preferences Screen



#### General Preferences Screen Buttons

Button	Function
	SELECT PREVIOUS: Press to select the previous setting in the list.
	SELECT NEXT: Press to select the next setting in the list.
	For settings with a list of options, press to select the next option.
	For settings with a list of options, press to select the previous option. Press and hold to move through options more quickly.
	Press to return to the Setup screen.

#### Savings Preferences Screen

To open the Savings Preferences screen, select Savings Preferences from the Setup Screen (Figure 18, page 39).

Use this screen to enter base values used to calculate the savings to your organization from using the BladderScan® BVI 9400 rather than catheterization.



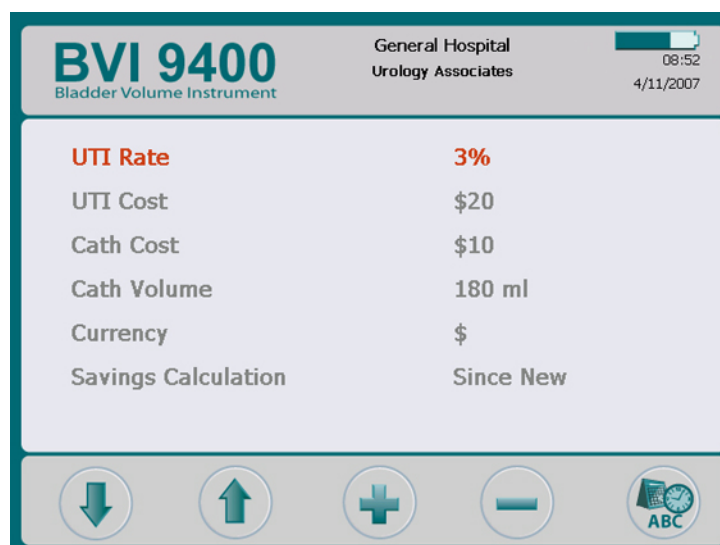

Preferences lists and options:

- ◆ **UTI Rate:** 1% to 100% in increments of 1%
- ◆ **UTI Cost:** \$10 to \$10,000 in increments of \$10
- ◆ **Catheter Cost:** \$1 to \$1000 in increments of \$1
- ◆ **Catheter Volume:** 20 ml to 1000 ml in increments of 20 ml
- ◆ **Currency:** \$ / € / £ / ¥
- ◆ **Saving Calculation:** Since New, Since 1/1/2006, Reset Now, Print Since New, Print Recent, Hide Savings

Figure 22. Savings Preferences Screen



**Savings Preferences Screen Buttons**

Button	Function
	SELECT PREVIOUS: Press to select the previous setting in the list.
	SELECT NEXT: Press to select the next setting in the list.
	For settings with a list of options, press to select the next option. Press and hold to move through options more quickly.
	For settings with a list of options, press to select the previous option. Press and hold to move through options more quickly.



Button	Function
	Press to save the current date/time setting and return to the Setup screen.

### Self-Test Screen

To open the Self-Test screen, select Self-Test from the Setup menu (Figure 18, page 39). The Self-Test screen will open and testing begins automatically.

Figure 23. Self-Test Screen

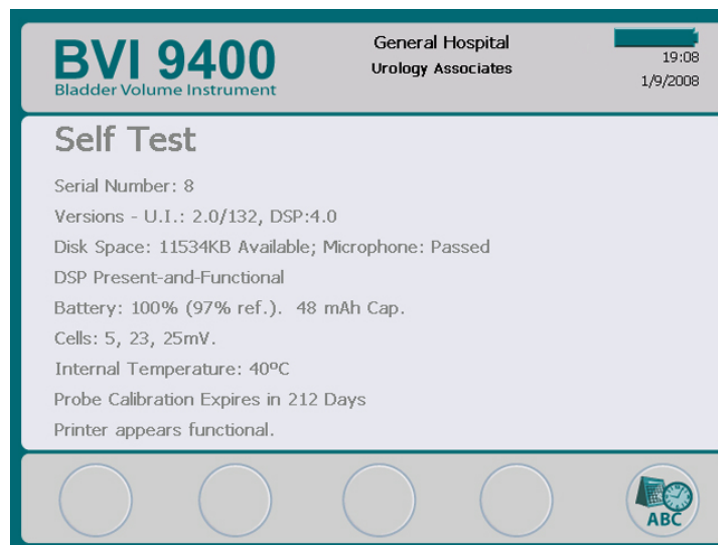

### Self-Test Screen Buttons

Button	Function
-	No function
-	No function
-	No function
-	No function.
	Press to return to the Setup screen.

### ScanPoint® Screen

**NOTE:** Only available if optional ScanPoint® software is installed on a PC.

To open the ScanPoint® screen, press  from the Home screen (Figure 12, page 18). The ScanPoint® screens display information about the status of the link between the BladderScan® instrument and the ScanPoint® host computer (Figure 24).

**Figure 24. ScanPoint® Screens**



### ScanPoint® Screen Buttons

Button	Function
-	No function.
-	No function.
-	No function.
	CANCEL: Cancels the current action and ends communication with ScanPoint®.
-	No function.

### Sleep Mode

The Sleep mode helps preserve battery power. After four minutes of idle time, a Sleep mode alert message displays for 15 seconds (Figure 25). While the message is displayed, press any button to keep the console awake and dismiss the message. After 15 seconds, the console goes to sleep. To wake the instrument from sleep, simply press the Power button.

Figure 25. Sleep Mode Screen

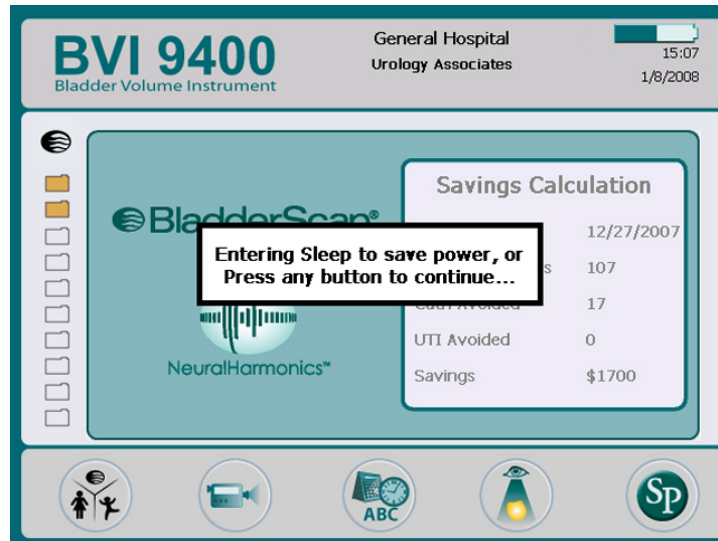

### Memory Optimization During Power Down

When the power is turned off, the BVI 9400 begins an internal process of memory optimization. This process takes several minutes. When complete, the device will shut down. An alert appears on the display during the memory optimization process (Figure 26).

Figure 26. Memory Optimization Alert

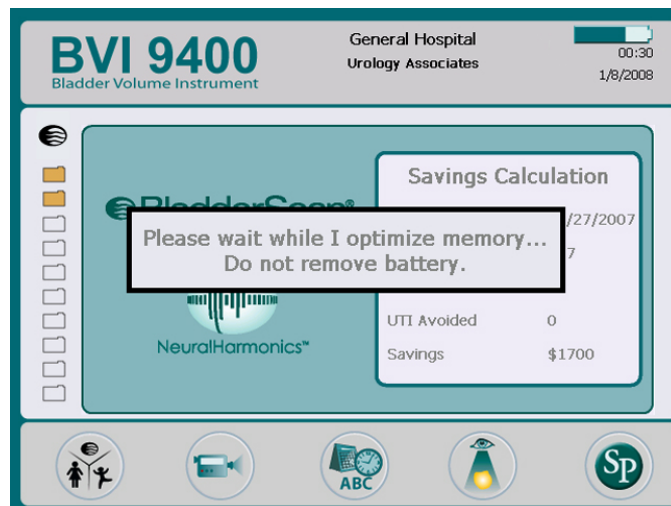

**NOTE:** DO NOT replace the battery until the device shuts down completely. Replacing the battery while memory is being optimized might disable the instrument as program and exam files might not be rewritten properly.

## Measuring Bladder Volume

### Preparing for the Exam

#### Before You Begin the Exam:

- ◆ Make sure you are familiar with the parts of the BladderScan® instrument (see Introducing the BladderScan® BVI 9400 on page 17).
- ◆ If you are a new BladderScan® user, Verathon® recommends that you perform your first exam on a patient with a moderately full bladder, rather than initially attempting to locate and scan a nearly empty bladder.
- ◆ Check the instrument's battery icon to make sure the battery has sufficient power.

**NOTE:** If the battery icon is 1/4 or less full, replace the battery with a freshly charged battery before proceeding. Place the discharged battery in the Battery Charger to recharge.

- ◆ Clean and disinfect the Probe by wiping it gently with a soft cloth soaked in isopropyl alcohol.

Be aware of the following conditions the patient may have that could affect ultrasound transmission and the accuracy of your exam:

- ◆ A catheter in the patient's bladder. The presence of a catheter may affect the accuracy of the bladder volume measurement, but the measurement may still be clinically useful (detecting a blocked catheter, for example).
- ◆ Previous suprapubic or pelvic surgery. Scar tissue, surgical incisions, sutures, and staples can affect ultrasound transmission and reflection.

#### Do not use the BVI 9400 on:

- ◆ Patients with ascites
- ◆ Patients with open skin or wounds in the suprapubic region.
- ◆ Pregnant patients

## Measuring Bladder Volume

1. **Turn on the BVI 9400.**  
Turn on the BVI 9400 by pressing the ON/OFF button.



2. **Select the exam mode.**



Select to scan a patient with height less than 48 inches (122 cm) tall and weight less than 60 lbs (27 kg).



Select to scan a female patient who has not had a hysterectomy.



Select to scan all other patients.



3. **With the patient supine apply gel.**  
Have the patient lie in the supine position with the abdominal muscles relaxed.

Palpate the patient's symphysis pubis (pubic bone). Place an ample quantity of gel (with as few air bubbles as possible) midline on the patient's abdomen, approximately one inch (3 cm) above the symphysis pubis (pubic bone).



**4. Aim toward the bladder.**

Standing at the patient's right side, place the Probe on the gel and aim it toward the expected location of the bladder. For most patients, this means angling the Probe slightly toward the patient's coccyx (tail bone) so the scan clears the pubic bone.



**5. Press the SCAN button.**

Press the SCAN button, located on the underside of the Probe. As the scan progress, sections of the bladder will appear on the Console screen. When you hear the end-scan tone, the scan is complete.

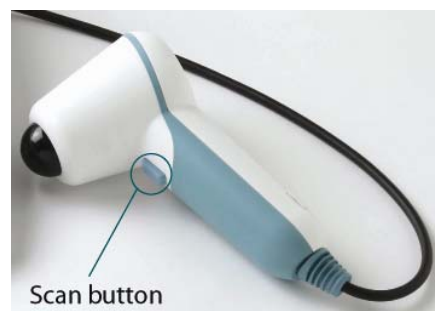

**6. Verify the scan.**

If the scan is "on target" the Probe will display eight arrows. On the Console display, the bladder will be appear in the center of the crosshairs.

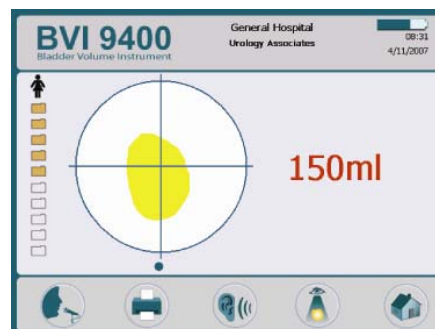

**6a. Re-aiming.**

If the scan is "off-target" the Probe will show an arrow indicating the direction to move the Probe to be "on target." If the arrow is solid, it means you are slightly "off target" and must re-aim and re-scan. On the Console, the bladder will not be in the crosshairs, and there will be an arrow pointing in the direction for re-aiming.

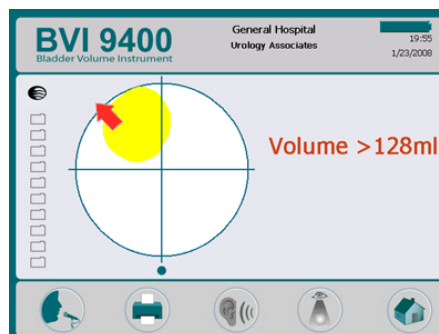

**6b. To re-aim:**

Note that the crosshairs correspond to the anatomy of the patient as follows:

- ◆ The small dot at the base of the crosshairs represents the feet of the patient.
- ◆ The top of the crosshairs represents the patient's head.
- ◆ The upper left quadrant represents the patient's right shoulder.

This orientation should help you in re-aiming the Probe to capture the complete bladder fully in the ultrasound cone.

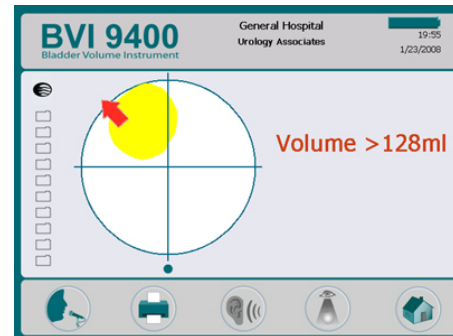
**6c. Pubic Bone.**

You may also see a display indicating that the pubic bone is inside the ultrasound cone. If this occurs, you may want to re-aim and re-scan. Although the bladder may be shown as centered in the ultrasound cone, and your measurement may be complete, there is a possibility that the pubic bone is obscuring part of the bladder. By re-aiming and re-scanning you can ensure you have captured the bladder fully inside the ultrasound cone.

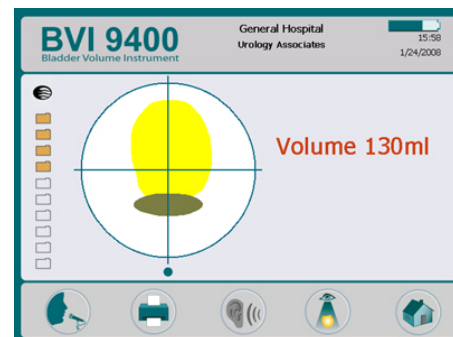
**7. Save, review, and print exam results.**

- ◆ **To save the exam** you must annotate it.
- ◆ **To annotate**, press and release the RECORD button on the Console. When you see the RECORD button icon change to a STOP button icon, record the patient information by speaking into the Probe microphone. When the hourglass icon disappears, press the LISTEN button to replay the annotation.
- ◆ **To review** the scan images, press the REVIEW button. (You must first save the exam before you can review it.)
- ◆ **To print** exam results via the on-board printer, press the PRINT button.
- ◆ **To perform** another exam, press the HOME button.





## 8. Finish the exam.

Once you have completed the scan, wipe the ultrasound gel off the patient and the Probe. For ScanPoint® subscribers, logging onto ScanPoint® automatically transfers and saves your annotated exams to your Windows® computer.

## Additional Scanning Tips

Applying too much pressure when scanning will lead to a Greater Than symbol (>) preceding the measurement. Apply less pressure and re-scan.

Hold the device steady while scanning. Movement will result in an inaccurate reading.

Volume reading will be affected by:

- ◆ The presence of scar tissue
- ◆ The presence of a catheter
- ◆ Overly obese patients:

With obese patients, lift as much abdominal adipose tissue out of the way of the instrument as possible. Apply more pressure to the BladderScan® BVI 9400 instrument to reduce the amount of adipose tissue through which the ultrasound must pass.

To ensure accurate results, make sure that:

- ◆ There are no air gaps between the Probe and the patient's skin.
- ◆ The gel pad is intact (not broken or cracked).
- ◆ There are no air bubbles under the gel pad.
- ◆ You are holding the instrument steady while scanning (avoid changing its position, angle, or pressure).
- ◆ You are using enough pressure to maintain good skin contact until the scan is complete.
- ◆ There is not a catheter in the patient's bladder. The presence of a catheter may affect the accuracy of the bladder volume measurement, but the measurement may still be clinically useful (detecting a blocked catheter, for example).

**NOTE:** The BVI 9400 is able to scan rapidly and repeatedly throughout the day. If however scans are taken quickly, in rapid succession, over a 30 minute period, some slowing in performance may be noticed. While this may occur rarely, it is normal for the instrument.

## Recording a Voice Annotation

After performing an exam, you can record additional information about a patient to be stored with the exam results.

The instrument can store ten scans with voice annotations, so you can perform multiple exams on your rounds. If you are using the optional ScanPoint® with QuickPrint software,

you can upload saved exams to your PC. (Refer to the ScanPoint® with QuickPrint User's Manual for more information.)

**To record a voice annotation:**

1. Press the RECORD button (microphone). A STOP button is now displayed.
2. The microphone is located just above the aiming display on the Probe. Hold the microphone approximately 6 inches (15 cm) from your mouth when you are recording the annotation, and speak clearly.



Be sure to include all relevant exam information, including the patient's name and the name of the person performing the exam.

3. When you have finished your annotation, press the RECORD button again.
4. When you have finished your annotation, press the STOP button. An hour glass will be displayed while your annotation and exam are updated and stored. After the annotation has been saved, to listen to your annotation, press the LISTEN button.



If you are not satisfied with the recording, press RECORD again to record a new annotation.

**IMPORTANT!**

- ◆ If you do not record a voice annotation for a particular exam, that exam will be lost and the next exam you perform will overwrite the non-annotated one.
  - ◆ If the instrument battery runs low or the instrument goes into sleep mode, any non-annotated exam data is lost. However, the instrument does not erase any annotated exam results when it goes into sleep mode. To make sure you do not lose any patient data, it is a good idea to add a voice annotation to every patient exam.
  - ◆ You can make a new recording only if the instrument still displays the bladder volume for that particular exam.
5. When you are satisfied with your recording, wait while the instrument automatically accepts and stores the recording with the exam results. The volume displayed on the LCD screen disappears, and the instrument is ready to perform another measurement.
  6. If you are using the BVI 9400 in conjunction with the optional ScanPoint® with QuickPrint software, you can view exam results and annotations on your Windows PC. Please refer to the ScanPoint® with QuickPrint User's Manual for more information.

## Deleting a Saved Exam

Saved exams are indicated by yellow folder icons along the left edge of the display. To delete a saved exam:

1. Open the Review Screen. (From the Home Screen press )
2. Press the  button until the desired exam is highlighted (blue).
3. Press the  button to delete the exam.

## Printing

You can use the BVI 9400 onboard Printer to print the ultrasound images captured during the scan (Figure 27 is an example).

To print exam results press the PRINT button immediately following the exam.

### Adding Addition Information

The label provides fields for Patient ID, Patient Name, Operator, and Physician. This information must be entered manually.

**Figure 27. Exam Results Printout Using the Onboard Printer**

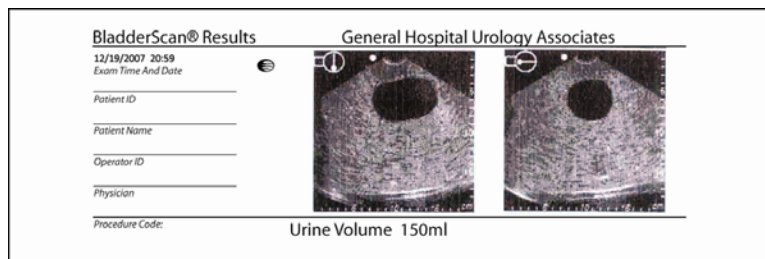

**NOTE:** If the facility name, date, and time have not been set, those lines will be skipped on the printout.

The BVI 9400 prints on thermal paper, which fades over time. For maximum storage life, Verathon® recommends that you photocopy the printout.

## Histogram of Cost Savings

Each volume measurement from a completed scanning procedure is stored in the BVI 9400 memory in one of eleven volume ranges (each with a 100 ml increment). This data is analyzed and can be displayed on the BVI 9400 at any time. The cost savings screen lists: Date Started, Number of Scans, Cath Avoided, UTI Avoided, Savings.

### Cost Savings Criteria

Cost savings are based on the following criteria:

- ♦ **Catheterizations avoided:** Urinary catheterization is deemed unnecessary. Thus, by using the BVI 9400, these catheterizations are avoided. The default setting (for volume below which catheterization is unnecessary) is 200 ml.
- ♦ **UTIs avoided:** Studies indicate that a certain percentage of catheterizations lead to urinary tract infections (UTIs).

By avoiding unnecessary catheterizations, the resulting UTIs are thereby avoided. The default setting (for percent of catheterizations leading to UTIs) is 3%.

- ♦ **Associated UTI costs:** Literature suggests that the additional costs associated with treating UTIs amounts to \$680.00 per patient infection. The default setting is \$680.00.
- ♦ **Cost of catheter kits:** The default setting is \$3.00 per kit.
- ♦ **Total Cost Savings from Using the BVI 9400 =**  
(Catheterizations avoided x catheter costs) + (UTIs avoided x UTI costs)

**NOTE:** The default settings can be changed to reflect the rates and costs at your facility by selecting from the Home screen:  (SETTINGS) > SAVINGS PREFERENCES. See page 43, "Savings Preferences Screen" for more information on customizing Savings Preferences.

## Cleaning and Maintenance

### Cleaning and Disinfecting the BladderScan® BVI 9400

#### To Clean and disinfect the BladderScan® BVI 9400:

1. Use a soft cloth dampened with isopropyl alcohol (or an appropriate hospital cleaning agent) to wipe the Probe until it is thoroughly cleaned.
2. If you use a detergent solution to clean the instrument, remove all residual detergent. Dry the instrument with a clean, soft cloth.
3. If the instrument needs to be disinfected, dampen a soft cloth in any glutaraldehyde-based hospital disinfectant solution such as Cidex® or Cidex 7® from Advanced Sterilization Products, or Sporocidin® from Sporocidin International. Wipe the instrument with a dampened cloth.
4. To remove all traces of disinfectant solution and wipe the instrument with a clean soft cloth dampened in sterile water or cleaning solution. Verathon® recommends wiping the device three separate times to remove all residual disinfectant.
5. Thoroughly dry the instrument with a clean, soft cloth before using.

**IMPORTANT!** Failure to heed the following warnings may cause device damage not covered by the BladderScan® BVI 9400 warranty.

- ◆ Do not immerse the instrument in disinfectant solution.
- ◆ Do not use CidexPlus® to disinfect the instrument. CidexPlus will damage the plastic enclosure.
- ◆ Do not subject any part of the instrument to steam sterilization or ethylene oxide sterilization.
- ◆ Changing gel pads between patients is strongly recommended.

### Regular Inspections and Maintenance

Verathon Medical® recommends that the BVI 9400 be certified by an authorized BladderScan® Service Center once a year. Certification service includes comprehensive inspection and testing of the instrument to ensure accurate performance in clinical use. For more information, please contact your authorized BladderScan® Service Center, your local BladderScan® distributor, or Verathon Medical® Customer Care Department at 1.800.331.2313 (North America only. International customers, please refer to the contact information on page 64).

**NOTE:** ScanPoint® Online customers can maintain device certification via the Internet by accessing their ScanPoint® account. For more information about using ScanPoint® Online, please refer to the ScanPoint® with QuickPrint User's Manual.







### Weekly Inspections

Once a week, you should inspect the Probe and cable for physical faults or cracks. Cracks that allow the ingress of fluid may affect the performance of the instrument. Any apparent cracks or faults in the Console, Probe, or the cable that links the Console and the Probe, must be referred to your authorized BladderScan® Service Center, your local BladderScan® distributor, your local Verathon Medical® representative, or the Verathon Medical® Customer Care Department.

**IMPORTANT!** If you see any physical faults or cracks in the instrument, discontinue use immediately and contact your local Verathon Medical® representative or the Verathon Medical® Customer Care Department at 1.800.331.2313.

### Using the Built-in Self-Test Utility

The BVI 9400 can perform a number of self-diagnostic tests. To access the Self-Test utility:

1. From the Home screen, press the SETTINGS button: 
2. When the Settings screen opens, press the  or  buttons until SELF-TEST is highlighted (red), then press  to open the Self-Test screen.
3. When the Self-Test screen opens, testing begins automatically with the display providing status and results.
4. When test is complete, press the SETTINGS button  to return to the Settings screen, then press the HOME button  to return to the Home screen.
5. If any test results were failed or abnormal, contact your authorized BladderScan® representative, or contact the Verathon Medical® Customer Care Department at 1.800.331.2313.

### Calibrating the BladderScan® BVI 9400 Using the ScanPoint® System

You must periodically calibrate your BladderScan® BVI 9400 to make sure your instrument is providing the most accurate results. Calibrating ensures accurate and proper alignment of the instrument's internal coordinate system. If you do not perform the calibration by the prescribed date, the instrument can still be used to take scans but measurements may be compromised.

When calibration is required, a warning appears in the display header (Figure 28).

Figure 28. Calibration Warning

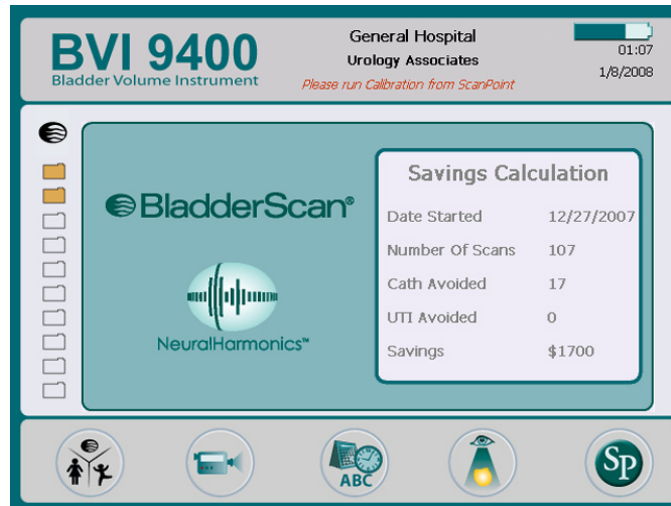

If you do not have ScanPoint® with QuickPrint, you must send your instrument in to an authorized Verathon® service center for calibration. Contact your Verathon® Medical Customer Care Center for more information. For contact information, please see Contacting Verathon® on page 64.

### Self-Calibration

Self-calibration requires the ScanPoint® with QuickPrint System and a Calibration Kit (P/N 0620-0340). For instructions on software requirements and installation, please refer to the ScanPoint® with QuickPrint User's Manual.

The entire calibration process takes approximately 15 minutes. ScanPoint® Online plans allow for calibration of the instrument as often as you like. You do not need to wait until the next scheduled calibration date. However, at a minimum, you must calibrate the instrument once every 12 months.

### Device Repair

The BladderScan® BVI 9400, Probe, and Battery Charger/Wireless Hub are completely sealed. There are no user-serviceable components. Verathon® does not make available any type of circuit diagrams, component parts lists, descriptions, or other information that would be required for repairing the device and related accessories.

Premium Warranty customers have access to a loaner replacement unit and free shipping options which vary according to plan.

If you have any questions, contact your local Verathon Medical® representative or the Verathon Medical® Customer Care Department at 1.800.331.2313.

### Unit Disposal

The BladderScan® BVI 9400 and related devices may contain lead, mineral oils, batteries, and other environmentally hazardous materials. When the BladderScan® BVI 9400 has reached the end of its useful service life, return the device, Battery Charger/Wireless Hub, and related accessories to a Verathon® Service Center for proper disposal. Alternatively, follow your local protocols for hazardous waste disposal.

## Troubleshooting

### Help Resources

Verathon® provides an extensive array of customer service resources, described in the table below.

You can obtain copies of this manual, Quick Reference Cards, and clinical studies by visiting the Verathon® Web site at <http://www.verathon.com> or by contacting your Verathon Medical® representative. A complete listing of contact information is provided on page 64.







Resource	Description
BladderScan® BVI 9400 In-Service CD	CD included with your BVI 9400 that shows how to use the BladderScan®.
Onboard training modules	Training modules installed on your BladderScan® are available by pressing the  button from the Home Screen. Available titles include: Using the BladderScan® BVI 9400 and NeuralHarmonics™ Technology.
BladderScan® BVI 9400 Quick Reference Cards	Summary of procedures for using the BladderScan® system.
Clinical Studies	Scientific papers on BladderScan® use.
ScanPoint® Online	ScanPoint® Online provides customers: <ul style="list-style-type: none"> <li>◆ The ability to calibrate and certify devices online anytime you wish.</li> <li>◆ Automatic data backup and archiving (HIPAA compliant).</li> <li>◆ Automatic software upgrades.</li> <li>◆ Access to real-time troubleshooting from Verathon®.</li> </ul>





Resource	Description
Premium Warranty	<p>A Verathon® device warranty plan that provides all the benefits of ScanPoint® Online (preceding paragraph) and also:</p> <ul style="list-style-type: none"> <li>◆ All repairs performed free of charge.</li> <li>◆ Instrument insurance: A perpetual warranty against outdated technology with free upgrade / replacement when your device is no longer manufactured.</li> <li>◆ Free loaner program.</li> <li>◆ Free shipping.</li> </ul>
Verathon® Web site	<p><a href="http://www.verathon.com">http://www.verathon.com</a> includes many in-service training resources. From the Verathon® Home page, select “BladderScan®.” On the BladderScan® page, select “Customer Service.”</p>
Phone support	<p>In North America, call: 1.800.331.2313. International customers, please refer to the list of Customer Care Department phone numbers on page 64.</p>

### Icons on the BladderScan® Console

The following icons may appear on the instrument’s LCD screen.

Symbol	Meaning
	<p>(Solid arrow) The bladder is contained within the image cone (cone-shaped area in which the Probe transmits ultrasound waves), but not centered. You may be able to obtain a more accurate measurement by re-aiming the Probe in the direction indicated by the arrow.</p>
<b>Battery power level:</b>	
	◆ Indicates a fully charged battery.
	◆ Indicates a battery 50% to 75% charged.
	◆ Indicates a battery 25% to 50% charged.
	◆ Indicates a battery that is nearly discharged and can power only a few more scans.
	◆ Indicates the battery must be changed.
	<p>The patient is a small child with height less than 48 inches (122 cm) tall and weight less than 60 lbs (27 kg).</p>

Symbol	Meaning
	The patient is a female patient who has not had a hysterectomy.
	Select to scan all other patients.
	The bladder is too large to be contained within the scan cone, or the bladder contains more than 999 ml of urine.

## Diagnosing problems

### Instrument Does Not Turn On

If the instrument does not turn on, this is usually due to a dead or discharged battery and can be remedied by replacing the dead battery with a charged battery. Check the battery icon in the upper right corner of the LCD display. If the battery icon does not display any power segments, replace the battery.

When the battery charge is too low to allow normal operation (but not too low to permit operation of the internal circuitry) the device displays the following message:

BATTERY CHARGE LEVEL IS TOO LOW FOR  
INSTRUMENT OPERATION. RECHARGE BEFORE NEXT USE.

In this case, the battery must be recharged or replaced with a charged one.

### Printer Problems

#### No Paper

The BladderScan® BVI 9400 senses the presence of paper and automatically displays this image when the printer is out of paper (Figure 29).

Figure 29. Printer Out of Paper Screen

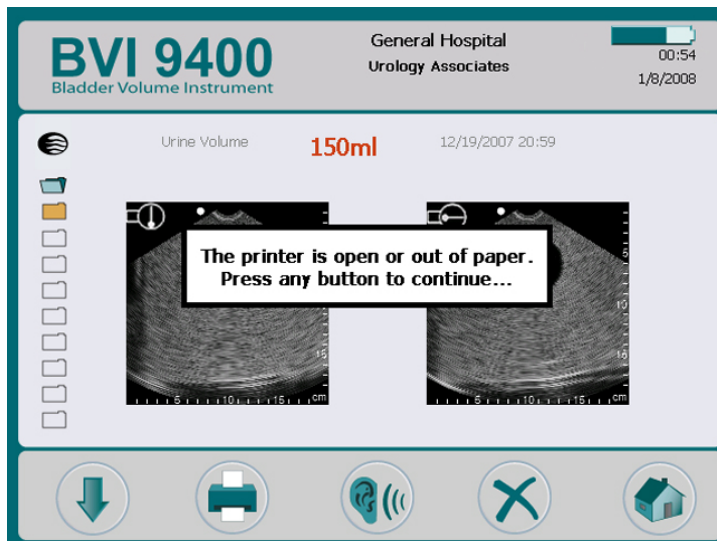

For instructions on loading paper, review the on-board training module or refer to the section in this manual titled *Load a Roll of Thermal Paper* beginning on page 27.

**Too Hot**

The BVI 9400 displays the message TOO HOT if the print head overheats. In this case, turn off the BVI 9400 immediately. This condition may be the result of a paper jam. To clear the paper jam see the following paragraph.

**Clearing a Paper Jam**

If the paper will not advance through the printer, gently pull the paper jam backward while moving the thumb wheel counterclockwise.

**CAUTION! Possible device damage.**

If the paper jam is inaccessible, do not try to disassemble the printer. Contact you authorized Verathon® Service Center or your local Verathon® distributor for service.

## Warranty

Verathon® Inc. warrants the BladderScan® BVI 9400 against defects in material and workmanship as long as it is covered by the Premium Warranty.

Damage or loss insurance is available as part of the Total Reliability<sup>SM</sup> Plan. Pursuant to this warranty, a service center authorized by Verathon® will repair or replace units that prove to be defective during the warranty period.

This warranty does not apply if the unit was misused or modified by anyone other than a service center authorized by Verathon®.

The unit must be used in accordance with the instructions contained in this manual. Consumable items are not covered in this warranty and should be used in conformance with Verathon® product specifications.

For further details, consult your Premium Warranty. Warranty conditions may differ in some countries outside the United States. Contact your local distributor for warranty terms.

### Disclaimer of Additional Warranties

There are no understandings, agreements, representations of warranties expressed or implied (including warranties of merchantability or fitness for a particular purpose) other than those set forth in the preceding Warranty section. The contents of this manual do not constitute a warranty.

Some states disallow certain limitations on applied warranties. The purchaser, user, and patient should consult state law if there is a question regarding this disclaimer. This information, descriptions, recommendations, and safety notations in this manual are based upon Verathon® experience and judgment with BladderScan® as of December 2007. The contents of this manual should not be considered to be all-inclusive, or to cover all contingencies.

The physician who directs the use of the BladderScan® BVI 9400 at the institution where it is in use is responsible for keeping current with clinical research in bladder volume measurements.

Please direct any questions or problems concerning bladder volume measurement, using the instrument, or the interpretation of data to the responsible physician.

## Contacting Verathon®

The team at Verathon® is committed to modernizing healthcare delivery by putting patients first. Our products support healthcare professionals by providing accuracy, utility, and excellence. For additional product and company information, visit the Verathon® Web site at <http://www.verathon.com>. If you have any questions or comments about Verathon® products and services, please contact us at:

---

<p><b>Corporate Headquarters (USA)</b> Verathon Incorporated 20001 North Creek Parkway Bothell, WA 98011 USA</p>	<p>Toll free: 800.331.2313 (US &amp; Canada Only) Tel: 425.867.1348 Fax: 425.883.2896 Web: <a href="http://www.verathon.com">http://www.verathon.com</a> Email: <a href="mailto:customerservice@verathon.com">customerservice@verathon.com</a></p>
--	--

---

<p><b>Verathon Medical B. V. (Europe)</b> <b>EC Rep</b> Boerhaaveweg 1 3401 MN IJsselstein The Netherlands</p>	<p>Tel: +31.30.68.70.570 Fax: +31.30.68.70.512 Web: <a href="http://www.verathon.eu/">http://www.verathon.eu/</a> Email: <a href="mailto:customerserviceeu@verathon.nl">customerserviceeu@verathon.nl</a></p>
--	---

---

<p><b>Verathon Medical Sarl (France)</b> <b>Office Address:</b> Espace Europeen de l'Entreprise 2 allée d'Oslo 67300 Schiltigheim France</p>	<p><b>Postal Address:</b> BP 10039 F-67012 Strasbourg Cedex France  Tel: +33(0)3.88.60.14.02 Fax: +33(0)3.88.60.46.87 Email: <a href="mailto:info@verathon.fr">info@verathon.fr</a></p>
--	---

---

<p><b>Verathon Medical Ltd. (United Kingdom)</b> The Granary Manor Farm Courtyard Aston Sandford, Aylesbury Buckinghamshire, HP17 8JB United Kingdom</p>	<p>Tel: +44.1844.299.207 Fax: +44.1844.299.218 Web: <a href="http://www.verathon.co.uk/">http://www.verathon.co.uk/</a> Email: <a href="mailto:customerserviceuk@verathon.co.uk">customerserviceuk@verathon.co.uk</a></p>
--	---

---

<p><b>Verathon Medical K. K. (Japan)</b> Executive Tower Azabudai 7F 1-4-3 Azabudai Minato-ku Tokyo, Japan 106-0041</p>	<p>Tel: +81.03.3560.3501 Fax: +81.03.3560.3502 Email: <a href="mailto:servicejp@verathon.com">servicejp@verathon.com</a></p>
---	--

---

## Safety and Performance Summary

- ◆ The BladderScan® BVI 9400 computes the volume of the urinary bladder based upon twelve cross-sectional ultrasound images. For maximum accuracy, be sure to hold the Probe motionless while scanning.
- ◆ The most accurate measurements are obtained when the patient rests quietly in a supine position.
- ◆ Errors in usage tend to result in the underestimation of bladder volume, except in cases where the Probe is moved during scanning. In this case, the measurement may overestimate the patient's bladder volume.
- ◆ We recommend that new users use the BladderScan® BVI 9400 to measure patients with moderately full bladders rather than initially attempting to locate a bladder with a low urinary volume.
- ◆ To conserve battery power, the BladderScan® BVI 9400 shuts itself down automatically when not in use (goes into "sleep").

**WARNING! Risk of explosion.**

There is a possible risk of explosion if the BladderScan® BVI 9400 is used in the presence of flammable anesthetics.

**WARNING! Risk of patient injury.**

Do not use the BladderScan® BVI 9400 on patients with open skin or wounds in the suprapubic region.

**CAUTION: Risk of inaccurate measurements.**

- ◆ Accuracy is compromised if the user does not obtain an optimal, repeatable image.
- ◆ The BladderScan® BVI 9400 is not intended for use on pregnant patients.
- ◆ The patient being scanned should not have a catheter in his/her bladder. This could create microbubbles in the bladder, which will compromise the accuracy of the measurement.
- ◆ Use care when scanning suprapubic and pelvic surgery patients. Scar tissue, surgical incisions, sutures, and staples can affect ultrasound transmission and reflection.

## Parts and Accessories

### BladderScan® BVI 9400 System Components

The following components are included with your BladderScan® BVI 9400 system.







Part Number	Description
<b>0570-0190</b> <b>0570-0188</b>	BVI 9400 system: Console and Probe. Transmits and receives ultrasound to measure a patient's bladder volume.
<b>0570-0193</b>	Battery Charger/Wireless Hub
<b>0400-0066</b>	Rechargeable batteries (2 included)
<b>0800-0319</b>	Roll of Thermal Paper: Properly sized paper for the on board Printer.
<b>0620-0340</b>	Calibration Kit (Optional - requires ScanPoint® with QuickPrint software)
<b>0800-0322</b>	Medical Cart (optional)
<b>0900-1606</b>	BladderScan® BVI 9400 User's Manual (on In-Service CD)
<b>0900-1500</b>	BladderScan® BVI 9400 In-Service CD (with User Manuals, Video Tutorial, and Quick Reference Cards)
<b>0900-1601</b>	ScanPoint® with QuickPrint User's Manual (on In-Service CD)
<b>0900-1446</b>	Quick Reference Cards - Demo/Use
<b>0900-1447</b>	Quick Reference Cards - Calibration

To order any of the above parts, contact your authorized Verathon Medical® sales representative or contact the Verathon Medical® Customer Care Department at 1.800.331.2313.

## Product Specifications

### Symbol Directory

The following table explains the industry symbols used to indicate the BladderScan® system compliance with international and national standards and regulations.

Symbol	Meaning
	Marked in accordance with Directive 2002/96/EC on Waste Electrical and Electronic Equipment (WEEE) (solid bar indicates product was put on the market after 13 August 2005.)
	Class II equipment protected throughout by double or reinforced insulation.
	Type BF applied part with EN/IEC-60601-1.
	CE marked in accordance with the Medical Device Directive (MDD).
	Canadian Standards Association (CSA) mark of certification to United States standards for electromedical equipment.
 #0400-0066	This unit is powered by a Lithium-Ion battery pack. The Verathon® part number for the battery pack is 0400-0066.



## Standards and Regulations Compliance

Verathon® certifies that all units are in compliance with all applicable international and national standards and regulations, including but not limited to the following:

Specification	Standard
International Electrotechnical Commission	EN/IEC 60601-1 Amendments 1 and 2 and EN/IEC 60601-1-2 (EMC)
Safety Standard	EN/IEC 60601-2
Medical Device Directive	MDD 93/42/EEC Annex 1
Canadian Standards Association	C22.2 No. 601.1-M90 (Master Contract No. 177198)
Underwriters Laboratories, Inc.	UL 60601-1
Health Insurance Portability and Accountability Act (HIPAA)*	

\*For details on Verathon® compliance with privacy rules, please refer to the information in the QuickPrint Help menu (select PRIVACY AGREEMENT).

### Electromagnetic Effects

There are no restrictions on the use of BladderScan® BVI 9400 due to its electromagnetic characteristics. Both the emissions from BladderScan® and the susceptibility of this instrument to interference from other sources are within prescribed limits of all applicable standards at the date of manufacture. The emissions test procedure that was used is specified in EN/IEC55011: 1991 for Group 1, Class A equipment (per EN/IEC60601-1-2, 36.201.1.7).

BladderScan® BVI 9400 is suitable for use in industrial, scientific, and medical (ISM) environments, and in domestic environments under the jurisdiction of a health care professional. An indication of adverse electromagnetic effects from BladderScan® BVI 9400 on another electronic device would be a degradation of performance in the other device when the devices are operated simultaneously. If such interference is suspected, separate the two devices as much as possible, or discontinue simultaneous operation, if practical, and contact Verathon®.

BladderScan® BVI 9400 will operate normally in the proximity of other potential interference sources, and has demonstrated immunity at a field strength of 3 V/m (per EN/IEC 60601-1-2, 36.202.2.1). You do not need to take any other precautions regarding exposure in reasonably foreseeable environmental conditions to magnetic fields, pressure, or variations in pressure, acceleration, or thermal ignition sources.

## BladderScan® BVI 9400 Instrument Specifications

For technical performance assessment in an acoustic laboratory, the Probe cannot be immersed in water.

Item	Specification
Input	Lithium Ion Battery Pack. Verathon P/N 0400-0066.
Output	No load to full load at rated voltage. Refer to unit label.
Insulation	The power supply is Class I with basic insulation to each terminal.
Transient Overvoltage:	Category II
Weight	5.2 lb (2.36 kg) (with battery)
Display	13.36cm W x 10.13cm H (5.26" W x 3.99" H) (640 x 480 pixels, 120 dpi)
Integrated printer	Thermal label printer
Languages	English, Chinese Traditional, Czech, Danish, Dutch, Finnish, French, German, Greek, Italian, Hungarian, Japanese, Korean, Norwegian, Portuguese (European), Spanish, Swedish, Turkish

### Ultrasound Output Parameters

Item	Specification
Maximum ultrasound $I_{spta}$ during a scan	$\leq 5.0 \text{ m W/cm}^2$
Maximum ultrasound $I_{sppa}$ during a scan	$\leq 60.0 \text{ W/cm}^2$
Maximum MI (Mechanical Index)	.95 max
Transducer diameter	13 mm (0.512 inches)
Transducer resonant frequency	3.0 MHz and 1.74 MHz
Transducer bandwidth	75% at 10 dB
Time from 3D scan initiation to result display	< 3 seconds
Penetration depth (in normal North American patient)	$\geq 15 \text{ cm}$

### Accuracy Specifications

The accuracy specifications assume the instrument is being used according to the instructions provided by Verathon®, scanning a tissue-equivalent phantom.

Specification	Description
Bladder volume accuracy	± 15%, ± 15 ml (on a Verathon® tissue-equivalent phantom)
Bladder volume range	0 - 999 ml (0-200ml in small child scan mode)

### BladderScan® BVI 9400 Operating Conditions

The BladderScan® BVI 9400 is designed to function properly within the following specifications:

Condition	Description
Use	Indoor
Ambient Temperature Range	+10 - +40° Celsius (+50 - +104° Fahrenheit)
Atmospheric pressure range	700 hPa - 1060 hPa
Relative humidity	30% - 75% non-condensing
Water resistance	Rated at IPX1 (indicates DRIP-PROOF, a higher than ORDINARY level of protection from drips, leaks, and spills)

### BladderScan® BVI 9400 Storage Conditions

The BladderScan® BVI 9400 is designed for storage under the following conditions:

Condition	Description
Storage	Indoor
Ambient Temperature Range	-20 - +60° Celsius (-4 - +140° Fahrenheit)
Atmospheric pressure range	500 hPa - 1060 hPa
Relative humidity	20% - 95% non-condensing

## BladderScan® BVI 9400 Displays, Controls, and Indicators

The BladderScan® BVI 9400 provides the following controls, connectors, and features:

### Instrument Buttons

Power ON/OFF, Brightness (▲/▼), Volume (▲/▼). SCAN and RECORD buttons are on the Probe. Five buttons below the Console LCD vary depending on current instrument mode as follows:

Screen/Mode	Active Buttons
<b>Start up screen</b> Appears when the instrument is turned on.	POWER, VOLUME, BRIGHTNESS (1) - (5) No function.
<b>Home Screen</b> Appears when the instrument is first turned on.	POWER, SCAN: opens Aim/Scan screen, (1) PATIENT TYPE: toggle between three modes: small child, female with uterus, all other patients, (2) TUTORIAL: opens tutorial screen, (3) SETUP: opens Setup screen (4) REVIEW: opens the review screen, (5) SCANPOINT®: transmits saved exams to ScanPoint®.
<b>Scan Screen:</b> Appears when the operator presses and holds the SCAN button.	POWER: No function SCAN: Press to take a scan. Buttons (1) - (5): No action.
<b>Results Screen</b> Appears when the operator releases the SCAN button (after aiming).	POWER, SCAN: opens Aim/Scan screen, (1) RECORD: press to record, release to replay, (2) PRINT: print to on-board label printer, (3) PLAY: press to play voice annotations, otherwise, no function, (4) REVIEW: opens review screen if a voice annotation has been recorded. Otherwise, no function. (5) HOME: return to Home screen.
<b>Review Screen</b> Review, replay, print, or delete saved exams	POWER, SCAN, (1) NEXT: select next exam in memory, (2) PRINT: print to on-board printer, (3) PLAY: replay voice annotation for currently selected exam, (4) DELETE: delete currently selected exam, (5) HOME: return to Home screen.
<b>Training Title Screen</b> View the menu of training modules.	POWER, (1) Skip back one chapter, (2) Play/Pause, (3) Skip Forward one chapter (4) No function, (5) Home (return to Home screen).
<b>Video Viewing Screen</b> The video viewing screen.	POWER, (1) No function, (2) Play/Pause, (3) Return to Training Title Screen (4) No function, (5) Home (return to Home screen).

Screen/Mode	Active Buttons
<p><b>Settings Screen</b></p> <p>Start screen for editing clinic name, date &amp; time, general preferences, savings preferences, and self-test options.</p>	<p>POWER, (1) Select next setting in list, (2) Select previous setting in list, (3) Enter (proceed to the selected screen), (4) No action, (5) Home (return to Home screen).</p> <p>Settings: Name, Date/Time, Preferences, Self-Test.</p>
<p><b>Alpha-Numeric Screen</b></p> <p>Displays alpha-numeric characters for entering information.</p>	<p>POWER, (1) Move down, (2) Move right, (3) Add currently selected character, (4) Delete currently selected character, (5) Return to main setup screen.</p>
<p><b>Date &amp; Time Screen</b></p> <p>Allows the user to set the date and time</p>	<p>POWER, (1) Move forward to next changeable unit, (2) Move back to previous changeable unit, (3) Add/toggle units as appropriate (hold down to move faster), (4) Decrease/toggle units as appropriate (hold down to move faster), (5) Save current date/time entries and return to main setup screen.</p>
<p><b>Preferences Screen</b></p> <p>Set preferences for language, time and date format, time zone, UTI rate and cost, and currency</p>	<p>POWER, (1) Select next setting in list, (2) Select previous setting in list, (3) Select next option/Enter, (4) Select previous option, (5) Home (return to Home screen).</p> <p><u>Preferences list and options:</u></p> <p><u>Languages:</u> English (default), Chinese Traditional, Czech, Danish, Dutch, Finnish, French, German, Greek, Italian, Hungarian, Japanese, Korean, Norwegian, Portuguese (European), Spanish, Swedish, Turkish.</p> <p><u>Date format:</u> mm/dd/yyyy, dd.mm.yyyy, yyyy-mm-dd</p> <p><u>Time Format:</u> 12-hour, 24-hour</p> <p><u>Time Zone:</u> scroll through available time zones</p> <p><u>Calibration Warning:</u> On (default), Off. When "On" is selected, a calibration warning will appear in the display header when the device requires calibration.</p> <p><u>Enable Small Child Mode (SCM):</u> On (default), Off. Select "Off" to disable Small Child Mode.</p> <p><u>UTI Rate:</u> 1% - 100% in increments of 1%</p> <p><u>UTI Cost:</u> \$10 - \$100,000 in increments of \$1</p> <p><u>Catheter Cost:</u> \$1 to \$1000 in increments of \$1</p> <p><u>Catheter Volume:</u> 20 ml - 100 ml in increments of 20 ml</p> <p><u>Currency:</u> \$ / € / £ / ¥</p> <p><u>Savings Calculation:</u> Since new, Since 1/1/2006, Reset Now, Print Since New, Print Recent, Hide Savings.</p>

Screen/Mode	Active Buttons
<b>Self-Test Screen</b>	POWER, (1) Scroll down, (2) Scroll up, (3) No function, (4) No function, (5) SETUP (Go back to setup screen).
<b>ScanPoint® Screen</b>	(NOTE: Only available when used with ScanPoint® with QuickPrint software.) POWER, (1) No function, (2) No function, (3) No function, (4) CANCEL, (5) No function.

### Instrument Display

The instrument display is divided into three horizontal panes:

- ◆ The center pane is the main display area. The user interface for the center pane varies depending on device mode.
- ◆ The header pane displays the institution name, date, time, and a battery status icon.
- ◆ The footer pane displays icons that indicate button functions (described in the preceding table).

Screen/Mode	Display
<b>Start-Up Screen appears when the instrument is turned on.</b>	Displays “BladderScan®” and a progress bar.
<b>Home Screen</b>	Memory indicator, Correct scanning technique graphic, Savings Calculation table.
<b>Scan Screen</b>	Appears when the operator presses the SCAN button. As bladder volume is calculated, the display refreshes and updates until the scan is complete.
<b>Results Screen</b>	Appears when a scan is complete. Prominently displays calculated bladder volume, patient type, available memory and animated Print icon (if Print is pressed).
<b>Review Screen</b>	Review currently save exams. Saved exam folders on left (currently selected folder is yellow) and ultrasound images associated with selected exam.
<b>Tutorial Screen</b>	The tutorial video.
<b>Setup Screen</b>	Lists available setting screens.
<b>Name Screen</b>	A grid of alpha-numeric characters.

Screen/Mode	Display
<b>Date &amp; Time Screen</b>	The date and time.
<b>Preferences Screen</b>	List of available settings and their current values.
<b>Self-Test Screen</b>	Displays test progress and results.
<b>ScanPoint® Screen</b>	When ScanPoint® with QuickPrint is installed: Displays status information about the ScanPoint® communication. For example, when uploading an exams displays a progress bar.

## Battery Charger/Wireless Hub Specifications

The Battery Charger/Wireless Hub is powered from a standard wall outlet (adaptable to international power standards). The Battery Charger/Wireless Hub can charge two batteries simultaneously.

### Operating Conditions

The following are proper operating conditions for the Battery Charger/Wireless Hub:

Specification	Description
Use	Indoor
Ambient Temperature Range	+5 - +40° Celsius (+41 - +104° Fahrenheit)
Atmospheric pressure range	70 kPa - 106 kPa
Relative humidity	30% - 75% non-condensing
Water resistance	Rated at IPX 0 (ordinary equipment without protection against ingress of water)
Computer connection	USB 2.0
Charger	Powered by a desktop DC power supply.
Input voltage	100 - 240 VAC RMS
Input frequency	50 - 60 Hz
Input current	1 Amp max
Input connection	2 wire IEC 60320 C7
Output	9v at 1 Amp
Insulation	Class II with double insulation

Specification	Description
Fuses	250 VAC, 2A, quick acting
Testing	CSA 60950-1-03/UL 60950-1

### Storage Conditions

Condition	Description
Use	Indoor
Ambient Temperature Range	+5 - +40° Celsius (+41 - +104° Fahrenheit)
Atmospheric pressure range	70 kPa - 106 kPa
Relative humidity	30% - 75% non-condensing
Water resistance	Rated at IPX 0 (ordinary equipment without protection against ingress of water)

### Battery Specifications

The BladderScan® BVI 9400 is provided with two Lithium Ion batteries. A battery icon on the instrument display is always present indicating how much power remains and when the battery needs to be changed. The user can change the battery whenever necessary. Removing a discharged battery and replacing with a fresh battery will not erase any saved exams or user settings. Use only the battery charger provided with the BVI 9400. Any other battery charger may damage the battery pack.

The batteries meet the following specifications:

Condition	Description
Battery type	Lithium Ion
Battery life	A fully charged battery can provide approximately 30 exams within a 24-hour period.
Charging time	Charging time offline will take no more than six hours from an empty battery to a full charge.



## Glossary

Term	Meaning
<b>Aiming arrows</b>	Arrows that appear on the LCD screen to indicate the location of the bladder relative to the Probe. A solid aiming arrow means re-aiming is optional.
<b>Battery Charger/Wireless Hub</b>	The unit that charges the Lithium Ion batteries that power the BladderScan® and simultaneously receives and sends information from/to a BVI 9400 instrument within communication range.
<b>BladderScan®</b>	The BladderScan® instrument transmits ultrasound energy to produce an image of the patient's bladder and determine bladder volume.
<b>Calibration</b>	Checking the accuracy and function of your BladderScan® by comparing it with a known standard.
<b>Calibration Kit</b>	Tools for calibrating your BladderScan®. The calibration container has a spiral-shaped target which provides a known reference in a spherical coordinate system. The calibration of the instrument to this known reference increases the accuracy of volume measurements.
<b>Console</b>	The main BladderScan® device that provides operating controls and communicates with the user via images and text displays on an LCD screen.
<b>Coupling medium</b>	A substance, such as ultrasound gel or a gel pad, that enhances the transmission of ultrasound waves.
<b>Flashing Aiming Arrows</b> 	Indicate the bladder is not inside the scan cone and the Probe needs to be redirected. The arrow shows the direction to move or tilt the BladderScan® to improve the measurement. Re-aiming is required.
<b>Gel pad</b>	Sontac® Gel Pad: A disc-shaped, gel-filled pad that enhances the transmission of ultrasound waves.
<b>HIPAA</b>	Health Insurance Portability and Accountability Act, enacted by the US Congress in 1996.  Title II of HIPAA, the Administrative Simplification provisions (AS), requires the establishment of national standards for electronic health care transactions and national identifiers for providers, health insurance plans, and employers. The AS provisions also address the security and privacy of health data. The standards are meant to improve the efficiency and

Term	Meaning
	effectiveness of the nation's health care system by encouraging the widespread use of electronic data interchange in the US health care system.
<b>Image cone</b>	During a bladder volume measurement, this is the cone-shaped area in which the Probe transmits ultrasound waves.
<b>Instrument</b>	In this manual, refers to the BladderScan® BVI 9400. The BladderScan® instrument transmits ultrasound energy to produce an image of the patient's bladder and determine bladder volume.
<b>LCD screen</b>	The LCD (liquid crystal display) screen on the BladderScan® Console that displays the bladder volume measurement, instrument status, and other exam settings and information.
<b>NeuralHarmonics™ Technology</b>	A patented BladderScan® technology that sharpens accuracy and accelerates speed of three-dimensional ultrasound bladder volume measurements.
<b>Probe</b>	The handheld part of the BladderScan® instrument that transmits ultrasound energy to the patient.
<b>SCAN button</b>	Located on the underside of the BladderScan® hand grip, this button is used to initiate the measurement.
<b>ScanPoint® bladder imaging technology</b>	The software and online service provided by Verathon® that prints exam results, maintains patient records, displays ultrasound images from exams, downloads software updates, and calibrates the BladderScan®.
<b>ScanPoint® with QuickPrint</b>	ScanPoint® with QuickPrint is a software program installed on your computer that communicates with ScanPoint® Online to help you quickly and easily download and print BladderScan® results.
<b>Sleep mode</b>	When the BladderScan® shuts down to conserve energy. Press any button to turn on the instrument.
<b>Solid aiming arrow</b>	Indicates the bladder is inside the scan cone but is not completely centered. The arrow shows the direction to move or tilt the BladderScan® to improve the measurement. Re-aiming is optional but not required.
<b>Supine position</b>	Refers to the patient laying on their back with their face upward.
<b>Suprapubic</b>	The area above the pubic bone.
<b>Symphysis pubis</b>	The front of the pelvis where the pubic bones meet.
<b>Ultrasonic</b>	Involving ultrasound. Ultrasound is sound at frequencies above the range that can be heard by the human ear.





For more information, call 800.331.2313 (in the U.S. and Canada) or contact your local Verathon Medical® representative. BladderScan®, ScanPoint®, Verathon® and Verathon Medical® are registered trademarks of Verathon Inc. in the United States and/or other countries. Copyright ©2008. All rights reserved.

### BladderScan® BVI 9400 Parts List

0570-0190	BVI 9400 Console
0570-0188	BVI 9400 Probe
0570-0193	Battery Charger/Wireless Hub
0400-0066	Lithium Ion Battery (2 provided)
0900-1606	BVI 9400 User's Manual (on In-Service CD)
0900-1601	ScanPoint™ with QuickPrint User's Manual (on In-Service CD)
0900-1446	Quick Reference Card -- Demo/Use
0900-1447	Quick Reference Card -- Calibration
0800-0319	Thermal Paper Roll for Printer
0900-1500	BVI 9400 In-Service CD
0800-0322	Mobile Cart (optional)
0900-1238	ScanPoint™ with QuickPrint Install CD
0620-0340	Calibration Kit (optional)
0800-0005	Acoustic Coupling Gel



**Corporate Headquarters**  
20001 North Creek Parkway/Bothell, WA 98011-8218 USA  
425.867.1348 / 800.331.2313 / 425.883.2896 Fax  
[verathon.com](http://verathon.com)

0900-2484-01-60