

BladderScan[®]

Bladder Volume Instrument



BVI 9600

User's Manual

BladderScan[®] BVI 9600

Bladder Volume Instrument

User's Manual

CAUTION: In the United States, federal law restricts this device to use by or on the order of a physician.

Table of Contents

Statement from the CEO	8
Important Information	9
Product Description	9
Intended Use Warnings and Cautions.....	10
Biological Safety	10
Statement of Prescription.....	10
Statement of Intended Use	10
Contraindications (U. S. Only)	10
Cautions and Warnings.....	10
Bluetooth® Wireless Technology.....	12
Introducing the BladderScan® BVI 9600	13
BladderScan® Parts and Features	13
Probe Components	14
Console Components	14
Battery Charger/Wireless Hub.....	15
Parts and Accessories.....	16
Getting Started	17
Unpack the Box and Check the Components	17
Charge the Batteries.....	17
Install a Battery Pack in the Console.....	18
Battery Care.....	18
Enter the Clinic Name.....	19
Set the Date and Time.....	20
Setting General Preferences and Savings Preferences	21
Load a Roll of Thermal Paper	22
Assemble the Medical Cart	23
Medical Cart Parts List.....	23
Install the BVI 9600 BladderScan® on the Medical Cart (Optional).....	25
Install the ScanPoint® with QuickPrint Software (Optional).....	25
Watch the Training Videos	26
Displays, Controls, and Indicators	27
Console Displays and Button Functions.....	27

Battery Status Indicator.....	27
Home Screen	27
Scan Screen	29
Results Screen.....	30
Review Screen.....	31
Tutorial Screen.....	32
Video Viewing Screen.....	33
Settings Screen.....	34
Alpha-Numeric Screen.....	35
Date & Time Screen.....	36
Date & Time Screen Buttons	37
General Preferences Screen	38
General Preferences Screen Buttons	39
Savings Preferences Screen	39
Self-Test Screen	41
ScanPoint® Screen	42
Sleep Mode	42
Memory Optimization During Power Down	43
Measuring Bladder Volume.....	44
Preparing for the Exam.....	44
Measuring Bladder Volume	45
Additional Scanning Tips.....	48
Recording a Voice Annotation.....	49
Deleting a Saved Exam	50
Printing.....	50
Adding Additional Information	51
Histogram of Cost Savings	52
Measuring Abdominal Aortic Diameter with AortaScan™ Mode	53
Introduction.....	53
Aiming Display	53
Results Display	53
Preparing for the Exam.....	54
Before You Begin the Exam	54
Measuring Abdominal Aortic Diameter.....	55

Partial Gas Obstruction.....	57
Substantial Gas Obstruction	57
Obesity.....	58
Cleaning and Maintenance.....	60
Cleaning the BladderScan® BVI 9600	60
Regular Inspections and Maintenance	60
Weekly Inspections	61
Using the Built-in Self-Test Utility	61
Calibrating the BladderScan® BVI 9600 Using ScanPoint® Technology.....	61
Self-Calibration	62
Device Repair	62
Unit Disposal	62
Troubleshooting.....	63
Help Resources	63
Icons on the BladderScan® Console	64
Diagnosing problems.....	65
Instrument Does Not Turn On.....	65
Printer Problems	65
No Paper	65
Too Hot	66
Clearing a Paper Jam	66
Warranty.....	67
Disclaimer of Additional Warranties	67
Contacting Verathon®	68
Safety and Performance Summary	69
Parts and Accessories.....	70
BladderScan® BVI 9600 System Components.....	70
Product Specifications	71
Symbol Directory	71
Standards and Regulations Compliance	72
Electromagnetic Effects.....	72
BladderScan® BVI 9600 Instrument Specifications.....	73
Ultrasound Output Parameters - Acoustic Output Limits.....	73

Accuracy Specifications	74
BladderScan® BVI 9600 Operating Conditions	74
BladderScan® BVI 9600 Storage Conditions	75
BladderScan® BVI 9600 Displays, Controls, and Indicators	75
Instrument Buttons	75
Instrument Display	77
Battery Charger/Wireless Hub Specifications	79
Operating Conditions	79
Storage Conditions	80
Battery Specifications	80
Glossary	81

Table of Figures

Figure 1. BladderScan® BVI 9600 Controls and Indicators	13
Figure 2. Battery Charger/Wireless Hub	15
Figure 3. Home Screen	19
Figure 4. Settings Screen.....	19
Figure 5. Alpha-Numeric Screen.....	20
Figure 6. Facility Name in Display Header.....	20
Figure 7. Set Up Screen - Date and Time.....	21
Figure 8. Date and Time Screen	21
Figure 9. Medical Cart, PN: 0800-0322	23
Figure 10. Medical Cart Assembly	24
Figure 11. Attaching the BVI 9600 to the Medical Cart.....	25
Figure 12. Home Screen: Bladder Volume Mode	28
Figure 13. Home Screen: Aorta Scan™ Mode	28
Figure 14. Scan Screen	30
Figure 15. Results Screen.....	30
Figure 16. Review Screen.....	31
Figure 17. Tutorial Screen.....	33
Figure 18. Video Viewing Screen.....	34
Figure 19. Settings Screen Start Menu	35
Figure 20. Alpha-Numeric Screen.....	36
Figure 21. Date & Time Screen	37
Figure 22. B-Mode and C-Mode Print Reports	38
Figure 23. General Preferences Screen	39
Figure 24. Savings Preferences Screen	40
Figure 25. Self-Test Screen	41
Figure 26. ScanPoint® Screens.....	42
Figure 27. Sleep Mode Screen	43
Figure 28. Memory Optimization Alert	43
Figure 29. Exam Results Printout Using the Onboard Printer	51
Figure 30. BVI 9600 AortaScan™ Display.....	53
Figure 31. Calibration Warning	62
Figure 32. Printer Out of Paper Screen	66

Statement from the CEO

The team at Verathon® is committed to improving health care delivery by putting healthcare providers and their patients first.

Our products support you, the health care provider, by consistently offering accuracy, utility, reliability and excellence.

Please contact us directly at 1.800.331.2313 (USA and Canada only) or 1.425.867.1348, if we can improve our service to you.

Sincerely,

Gerald McMorrow

Gerald McMorrow, CEO, Founder and Chairman of the Board

Important Information

Product Description

The BladderScan® BVI 9600, with patented NeuralHarmonics™ technology, is a portable ultrasound instrument that provides noninvasive measurements of urinary bladder volume or abdominal aortic diameter. The device consists of an ultrasound Probe that scans the patient's bladder or aorta, and a compact, battery-operated Console that provides an array of measurement-related information.

BladderScan® is noninvasive and comfortable for the patient. It is accurate, reliable, quick and easy to use. When the user releases the scan button, within seconds, BladderScan® measures ultrasonic reflections on multiple planes inside the body and produces a three-dimensional image. Based on this image, the BladderScan® BVI 9600 calculates and displays the bladder volume or abdominal aortic diameter. A sonographer is not required.

Patent-pending NeuralHarmonics™ technology (abbreviated from “neural network harmonics”) in the BVI 9600, sharpens accuracy and accelerates speed of bladder volume measurement. Volume measurements made with NeuralHarmonics™ technology are more accurate than those from conventional two-dimensional ultrasound, as they are based on a more complex, multifaceted image of the bladder. This technology, applying multi-spectral analysis to a robust data set, helps reduce margin of error and minimize uncertainty in essential measurements of bladder function. Using patented V-MODE® technology, the BladderScan® BVI 9600 provides a noninvasive measurement of abdominal aortic diameter.

BladderScan® BVI 9600 measurements can be printed via an onboard printer or transmitted using HIPAA-compliant ScanPoint® technology for storage and archiving on Verathon® servers. Stored exams can be accessed at any time from your office's computer for viewing or printing. (**NOTE:** Use of ScanPoint® software is optional.)

If needed, after a scan has been taken, a unique aiming icon guides the operator to optimal Probe placement with a comprehensive, three-dimensional display showing the bladder in two cross-sectional images verifying that a complete scan has been achieved. Bladder volume, patient type, directional aiming with real-time feedback, battery status, and usage rate indicators are all displayed on the device's LCD screen. The BladderScan® BVI 9600 contains an on-board thermal printer that allows the user to print exam results quickly with the press of a button.

A Calibration Targeting System, consisting of a spiral-shaped calibration target along with a special calibration container, allows the user to easily calibrate the device by scanning a known target.

Optionally, exam results may be transmitted to a personal computer running ScanPoint® with QuickPrint software via a proprietary wireless connection. ScanPoint® with QuickPrint allows the user to archive data, calibrate the device, update software, print, and transfer data through a Web-based interface.

The BladderScan® BVI 9600 system also includes a universal battery charger for the custom, user-replaceable Lithium Ion battery incorporated in the system.

The BladderScan® BVI 9600 may be mounted on a wheeled cart which holds the instrument securely and provides a holder for ultrasound gel and other accessories.

Intended Use Warnings and Cautions

The BladderScan® BVI 9600 should be used only by individuals who have been trained and authorized by a physician or the institution providing patient care. All users must read this entire *User's Manual* prior to using the BladderScan® BVI 9600. Do not attempt to operate this instrument until you thoroughly understand all instructions and procedures in this manual. Failure to comply with these instructions may compromise the performance of the device and the reliability of its measurements. For the most current version of the *User's Manual*, please visit the Verathon® Web site at: <http://www.verathon.com>, then select the BladderScan® > Customer Support links to open a link to this manual and other training materials.

Biological Safety

To date, exposure to pulsed diagnostic ultrasound has not been shown to produce adverse effects. However, ultrasound should be used only by medical professionals when clinically indicated, using the lowest possible exposure times indicated by clinical need.

The ultrasound output power of the BladderScan® BVI 9600 is not user adjustable and is limited to the minimum level necessary for effective performance. Data on acoustic output levels can be found in the *BladderScan® BVI 9600 Instrument Specifications* section of this manual on page 73.

Statement of Prescription

United States federal law restricts the BladderScan® BVI 9600 to use by, or on the order of, a physician. This statement is required per 21 Code of Federal Regulations (CFR) 801.109.

NOTE:

It is standard practice to have medical staff authorize the use of the BladderScan® BVI 9600 within its intended use throughout an institution. Individual prescriptions for use are not required.

Statement of Intended Use

The BladderScan® BVI 9600 with AortaScan™ Mode is a user-selectable, dual-function ultrasound device that projects ultrasound energy either into the lower abdomen to obtain an image of the bladder for measuring bladder volume, or into the mid-abdomen to obtain an image of the abdominal aorta for aortic diameter measurements.

Contraindications (U. S. Only)

The BladderScan® BVI 9600 is not intended for fetal use or for use on pregnant patients.

The BladderScan® BVI 9600 is not intended for acute events such as aortic dissection, ulcer, or rupture.

Cautions and Warnings

To assure safe and reliable operation for the user and the patient, please read and heed the following warnings and cautions.

WARNING! Risk of explosion.

If you use the BladderScan® BVI 9600 in the presence of flammable anesthetics, the hazard of potential explosion exists.

WARNING! Risk of explosion, fire, or serious injury.

The BladderScan® BVI 9600 is provided with two Lithium Ion batteries. Never short circuit the battery pack by either accidentally or intentionally bringing the battery terminals into contact with any other conductive object. This could cause serious injury or fire and could also damage the battery pack and the BladderScan® device.

WARNING! Risk of explosion, fire, or serious injury.

Never expose the battery pack to abnormal shock, vibration, or pressure. The main battery pack's internal protective covering could fail, causing it to overheat or ignite, resulting in caustic liquid leakage, or explosion or fire, possibly resulting in serious injury.

WARNING! Potential patient hazard.

To date, exposure to low-power, pulsed diagnostic ultrasound has not been shown to produce adverse effects. However, medical professionals should use ultrasound only when clinically indicated, using the lowest exposure times possible to obtain accurate measurements. The ultrasonic output of the BladderScan® BVI 9600 is not user-adjustable and is limited to the minimum level necessary for effective performance. For more information about the acoustic output levels of this device, please refer to the section in this manual titled *BladderScan® BVI 9600 Instrument Specifications* on page 73.

CAUTION: Risk of inaccurate measurements/results.

When using the BladderScan® BVI 9600 with AortaScan® Mode be aware of the following conditions which can affect ultrasound transmission and decrease the accuracy of exam results.

- ◆ Visual verification that the aorta position is fully within the scan cone on the displayed images is important while in the AortaScan® Mode.
- ◆ Use care when scanning patients who have had supra-pubic or pelvic surgery. Scar tissue, surgical incisions, sutures, and staples can affect ultrasound transmission and accuracy.
- ◆ Do not use the BladderScan® BVI 9600 on a patient with open skin or wounds in the suprapubic region or mid-abdominal area.
- ◆ Do not use the BladderScan® BVI 9600 on a patient with ascites.
- ◆ If you scan a patient with a catheter in his/her bladder, the catheter may affect measurement accuracy. However, the information obtained from the measurement could still be clinically useful for detecting problems such as a blocked catheter.

CAUTION: Observe the following precautions in the safe use and care of the BladderScan® BVI 9600.

Hazardous materials present. Assure proper disposal.

The BladderScan® BVI 9600 and related devices may contain lead, mineral oils, batteries, and other environmentally hazardous materials. When the BladderScan® BVI 9600 has reached the end of its useful service life, return the device, charging cradle, and related accessories to a Verathon® Service Center for proper disposal. Alternatively, follow your local protocols for hazardous waste disposal.

Assure proper computer system configuration.

When using the BladderScan® BVI 9600 with optional ScanPoint® software, your computer must be minimally certified to EN / IEC / CSA / UL 60950 or 60101-1 standards. This configuration ensures that compliance to the EN/IEC 60601-1-1 system standard is maintained. Anyone connecting additional equipment to the BladderScan® BVI 9600 signal input port or signal output port configures a medical system, and is therefore responsible for ensuring that the system complies with EN/IEC 60601-1-1. If you need assistance, contact your biomedical staff, Verathon Medical® representative, or the Verathon Medical® Customer Care Department at 1.800.331.2313.

Assure proper distance from patient.

When transmitting data to or from your computer, make sure that the BladderScan® BVI 9600, accessories, and computer are outside the patient vicinity (more than six feet (2 meters) from the patient). Refer to UL 2601-1 Clause 2 deviation for the definition of patient vicinity.

Bluetooth® Wireless Technology

NOTE: This feature is used only with the optional ScanPoint® software.

The *Bluetooth* technology used in the BladderScan® BVI 9600 is compliant with:

- ♦ *Bluetooth* Specification as defined and approved by The Bluetooth Special Interests Group.
- ♦ Logo certification with *Bluetooth* wireless technology as defined by The *Bluetooth* Special Interest Group.

CAUTION: Risk of Fire and Burns. Regarding the battery, do not disassemble, heat above 60° C (140° F), or incinerate. Keep battery out of reach of children and in original package until ready to use. Dispose of used batteries promptly according to local recycling or waste regulations.

CAUTION: *Bluetooth* and Wireless LAN devices operate within the same radio frequency range and may interfere with one another. If you are using the BladderScan® BVI 9600 *Bluetooth* link and Wireless LAN devices simultaneously, you may experience less than optimal network performance or even lose your network connection. If this happens, you may need to move the BladderScan® and ScanPoint® host computer to an area away from the 2.4 GHz wireless LAN devices (40 meters/44 yards, or more).

Introducing the BladderScan® BVI 9600

The BladderScan® BVI 9600 is designed for simple, intuitive operation. However, to ensure safe and effective operation, before using the device:

- ◆ Familiarize yourself with the contents of this manual.
- ◆ Watch the training videos provided on the instrument and on the In-Service CD.

BladderScan® Parts and Features

The BladderScan® BVI 9600 has two main components: The Console and the Probe. The Console and Probe are linked by a detachable cable. The BladderScan® BVI 9600 controls and indicators are illustrated in Figure 1.

Figure 1. BladderScan® BVI 9600 Controls and Indicators

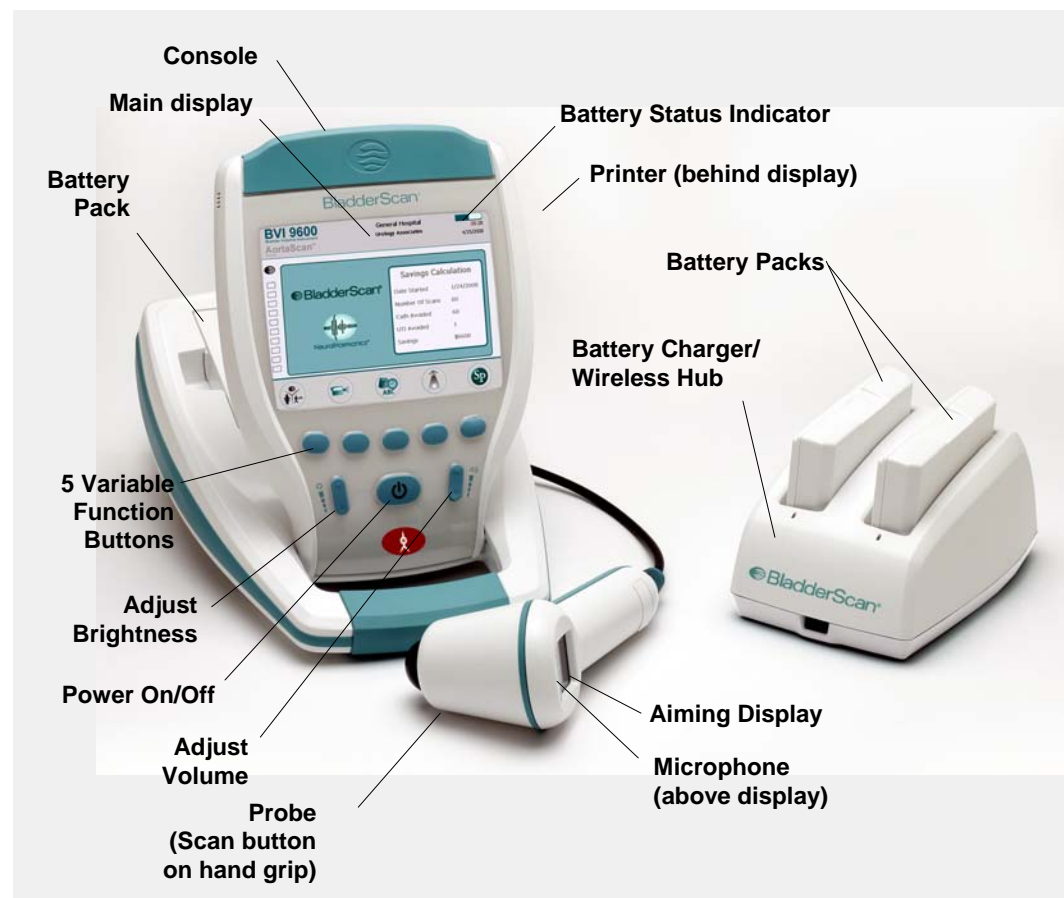

Probe Components

The Probe transmits and receives ultrasound waves, automatically moving its internal Probe 360° to scan twelve different planes to produce a three-dimensional image of the bladder. The Probe is attached to the Console by a cable. The Probe has three main features:

Part Name	Purpose
SCAN button	Press to take a scan.
Aiming Display	The LCD displays directional arrows to assure that the bladder is centered within the scanning cone.
Microphone	Records voice annotations.

Console Components

The Console provides all operating controls for the scanning process by means of five variable function buttons. The measured bladder volume or aortic diameter and target-shaped aiming icons are clearly displayed on the LCD screen. The Console also provides controls for adjusting brightness and volume, turning the power on/off, interfacing with a ScanPoint®-equipped computer (optional), and adjusting user settings and preferences. The Console also houses the battery and the printer. The Console's controls and features are described in the following table:

Part Name	Purpose
Main Display	Displays the bladder volume measurement, patient type, settings, and instrument status.
Power ON/OFF	Toggles main power on/off
Volume	Press to adjust volume up/down on voice annotation playback, start up sound, and "scan complete" tone.
Brightness	Press to adjust display brightness dimmer/brighter.
5 Variable Function Buttons	Depending on device mode, the buttons provide access to all instrument functions for scanning, recording annotations, printing, connecting to ScanPoint® (optional), accessing the training video, and setting user preferences.
Printer / Printer Door	Press to release the printer door.

Battery Charger/Wireless Hub

The BladderScan® BVI 9600 is powered by a Lithium Ion (Li-Ion) battery pack. The battery charger provided with your BVI 9600 can charge two Li-Ion battery packs while simultaneously functioning as the wireless hub linking your BVI 9600 to the ScanPoint® host computer.

NOTE: Use of ScanPoint® with QuickPrint software is optional.

- ◆ To provide power to the battery packs, the battery charger/wireless hub must be plugged into a wall outlet using the power cord provided.
- ◆ To provide wireless communication between the BVI 9600 and the ScanPoint® host computer, plug the battery charger/wireless hub USB connector into a USB port on the ScanPoint® host computer.

The battery charger/wireless hub maintains an operating distance of up to 120 feet (36 meters) between the ScanPoint® computer and the BVI 9600, regardless of barriers such as walls, ceilings, or windows.

Figure 2. Battery Charger/Wireless Hub

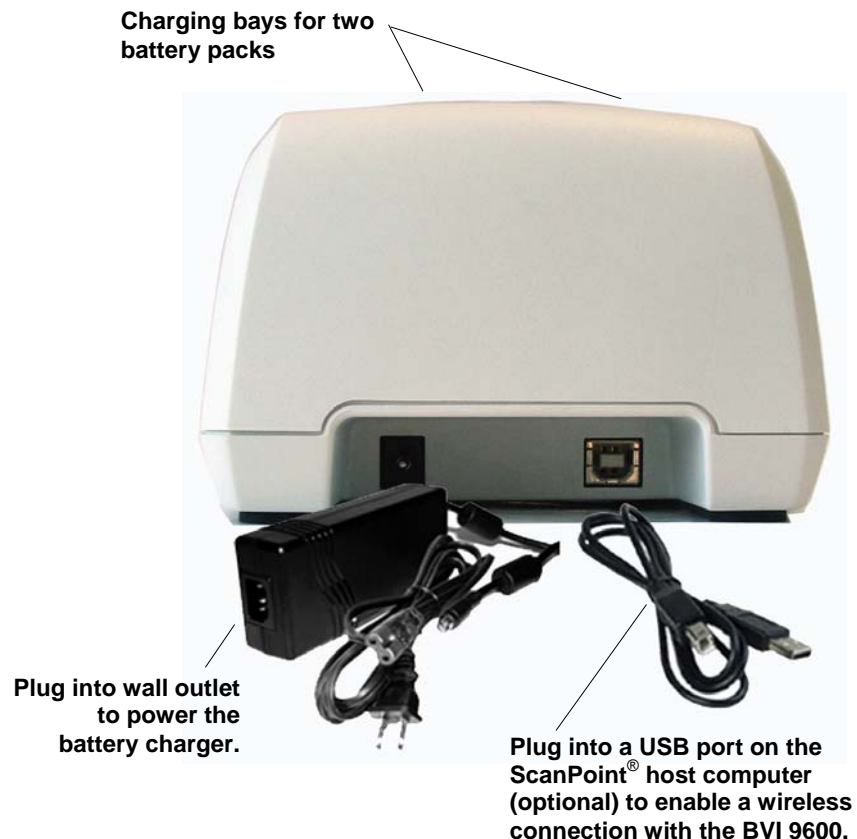

Parts and Accessories

Part Number	Description
0570-0212	BVI 9600 Console
0570-0351	BVI 9600 Probe
0570-0193	Battery Charger/Wireless Hub
0400-0066	Lithium Ion battery (2 provided)
0900-2147	BVI 9600 User's Manual (on In-Service CD)
0900-1601	ScanPoint® with QuickPrint User's Manual (on In-Service CD)
0900-1647	Quick Reference Card - BladderScan® BVI 9600 Bladder Volume Measurement
0900-1648	Quick Reference Card - BladderScan® BVI 9600 AortaScan™ Measurement
0900-1447	Quick Reference Card - Calibration
0800-0319	Thermal Paper Roll for the printer
0900-1644	BladderScan® BVI 9600 In-Service CD (Includes User's Manuals, Video Tutorials, and Quick Reference Cards)
0800-0322	Medical Cart (optional)
0900-1238	ScanPoint® with QuickPrint Software Install CD. NOTE: Use of the ScanPoint® software is optional and not required for operation of the BVI 9600.
0620-0340	Calibration Kit (Optional - Requires ScanPoint® with QuickPrint software. Includes Calibration Container, Calibration Target, etc.)
0800-0005	Acoustic Coupling Gel, 0.25 liter
0900-4344-00-60	BVI9600 User's Manual addendum

Getting Started

The previous section provided basic information about the BladderScan® BVI 9600 parts and features. This section provides instructions for setting up your BVI 9600 prior to first use.

To help you get up and running as quickly as possible, the next few pages explain how to:

- ◆ Unpack the BladderScan® BVI 9600 and related accessories
- ◆ Charge and install the batteries
- ◆ Customize the display (enter your institution's name, date, time, and other user data)
- ◆ Assemble the Medical Cart (optional)
- ◆ Install the ScanPoint® with QuickPrint software (optional)

Unpack the Box and Check the Components

Set the shipping container right side up and carefully open the top flaps (do not insert anything sharp through the top of the box). Remove the contents and verify that you have received everything listed below. If anything is missing or damaged, notify your authorized Verathon Medical® representative or Verathon Medical® Customer Care Department at 1.800.331.2313.

- (1) BladderScan® BVI 9600 (Console and Probe)
- (1) Medical Cart (optional)
- (2) Rechargeable Lithium Ion batteries
- (1) Battery Charger/Wireless Hub
- (1) In Service CD (includes User Manuals, Video Tutorial, and Quick Reference Cards)
- (1) Training Pack

Charge the Batteries

Two Lithium Ion batteries are included with the BladderScan® BVI 9600. One battery can be recharged in the battery charger/wireless hub while the other is installed in the BladderScan® instrument. This ensures that there is no instrument downtime. The charger will bring the batteries to a full charge within 6 hours or less.

NOTE: Before using the BladderScan® BVI 9600 for the first time, you will need to charge both batteries prior to first use.

To charge the batteries:

1. Plug the battery charger/wireless hub unit into a standard wall outlet.
2. Remove the label covering the battery contacts and insert the battery into the recess in the battery charger

NOTE: Fully charging the battery may take up to 6 hours.

Batteries may be stored in the charger. There is no danger of overcharging the batteries.

3. Check the colored indicator lights on the battery charger to determine battery status:
 - ♦ **Solid green:** Battery fully charged.
 - ♦ **Amber:** Battery charging.

Install a Battery Pack in the Console**WARNING! Risk of serious injury.**

If the battery pack is leaking or its case is cracked, put on protective gloves to handle it and discard it immediately. Always dispose of used battery packs in compliance with all applicable laws and regulations. Put insulating tape, such as cellophane tape, on the electrodes during transportation to avoid a possible short circuit, fire, or electrical shock. Failure to do so could result in serious injury.

To insert a battery pack:

Insert the charged battery into the battery well in the Console, slide it under the ledge and push down gently until the battery clicks into place.

NOTE: The battery pack is designed to prevent incorrect installation. If the battery pack does not slide into the battery well easily, move the battery and try again. Do not force the battery into position.

NOTE: Do NOT remove the battery for any reason while the BVI 9600 is on. Doing so will damage the instrument. Always turn off the BVI 9600 before removing the battery.

Battery Care

The BladderScan® BVI 9600 draws very little power when it is turned off. However, if you do not plan to use the BladderScan® instrument for several weeks, you should remove the battery to prevent it from discharging.

When batteries are not in use, they should be stored in the battery Charger so they remain fully charged.

Enter the Clinic Name

You can customize your BladderScan® BVI 9600 by entering your facility's name and current date and time. This information will subsequently be included on BladderScan® displays and all printouts of exam results.

NOTE: Use of extended-Latin and/or non-Latin characters: The following instructions explain how to enter a facility name that uses only standard Latin characters. Extended-Latin characters (tilde, umlaut, accents, circumflex, etc.) and/or non-Latin characters can be entered only by using ScanPoint® with QuickPrint software. To enter a name that uses extended or non-Latin characters, please refer to the instructions in the ScanPoint® with QuickPrint User's Manual.

To enter your clinic's name:



1. Turn the BladderScan® BVI 9600 on by pressing the POWER button  on top of the Console.
2. When the Home screen appears (Figure 3), press the SETTINGS button  to open the Settings screen.

Figure 3. Home Screen

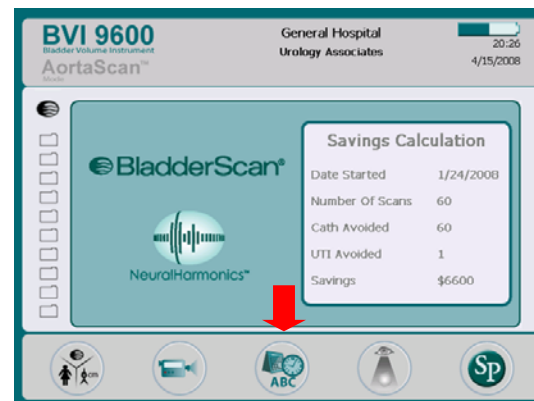



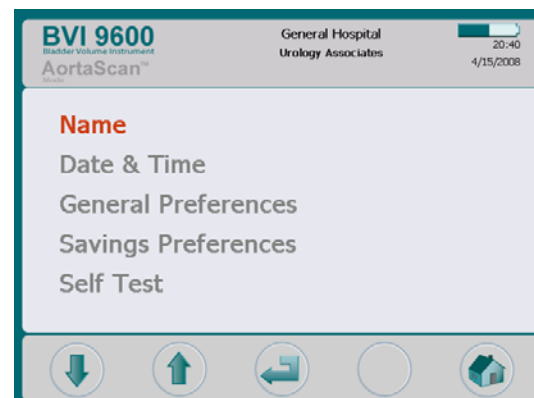

Figure 4. Settings Screen

3. On the Settings screen (Figure 4), push either the  or  button until **Name** is highlighted (red). Press the  button to open the Alpha-Numeric screen.



4. On the Alpha-Numeric screen (Figure 5), use the → and ↓ buttons to move to the desired character. When the desired character is highlighted (red), press the + button to add it to your text. Use the - button to delete characters.
 - ◆ To add a space between words, press the blank space below the letter “x”.
 - ◆ To add a second line of text use the ¶ character.

Figure 5. Alpha-Numeric Screen

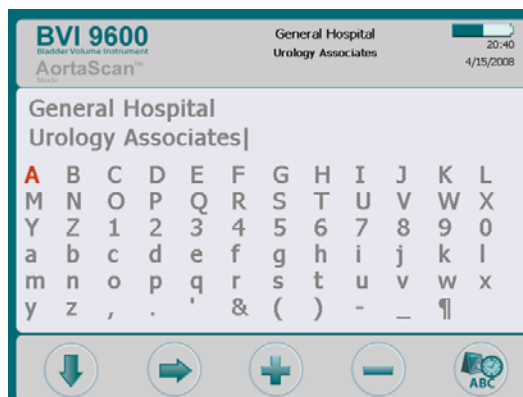



5. Continue to select and add characters as needed.
6. When finished, press the SETTINGS button  to return to the Settings screen. From the Settings screen, press the HOME button  to return to the Home screen. The facility name will now appear in the display header (Figure 6).



Figure 6. Facility Name in Display Header

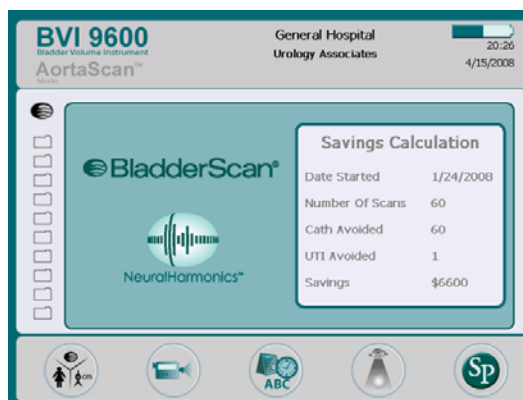

Set the Date and Time

The clock has its own Lithium battery and maintains the correct date and time for at least ten years provided the battery is installed in the instrument and charged. The clock can hold current time and date setting for up to five minutes after the battery is removed.

To set the date and time:

1. If the BladderScan® instrument is turned off, turn the power on by pressing the  button on the front of the Console.
2. From the Home screen (Figure 3), press the SETTINGS button  to open the Settings screen.





3. On the Settings screen, push either the  or  arrow until **Date & Time** is highlighted (red) (Figure 7). Press the  button to open the Date & Time screen.
4. On the Date & Time screen (Figure 8), use the  and  buttons to move to the desired unit (hours, minutes, month, day, year).

Figure 7. Set Up Screen - Date and Time



When the desired unit is highlighted (red),



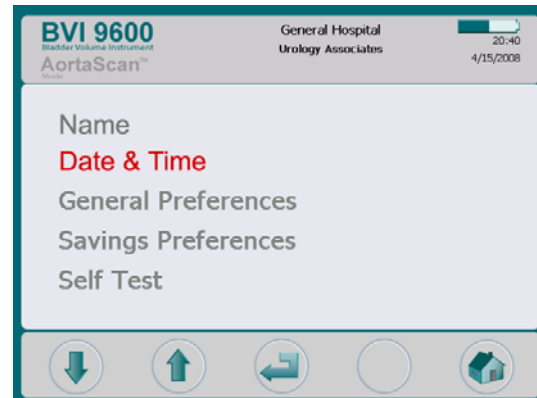

- ◆ Press the  button to increase values.
 - ◆ Press the  button to decrease values.
5. When the time and date are set correctly, press the SETTINGS button  to return to the Settings screen. From the Settings screen, push the HOME button  to return to the Home screen.

Figure 8. Date and Time Screen



Setting General Preferences and Savings Preferences

NOTE: See page 38 for information about setting General Preferences, Savings Preferences, and Self-Test Options.

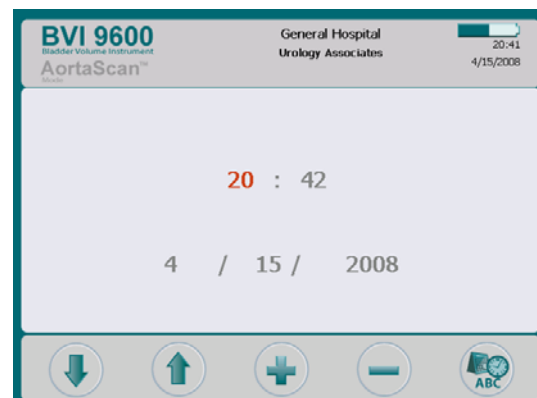
General Preferences, Savings Preferences, and Self-Test Options can be accessed from the Settings screen.

General preferences include options for: Language, Date Format, Time Format, Calibration Warning, and Print Report Type.

Savings Preferences include: UTI Rate, UTI Cost, Catheterization Cost, Catheterization Volume, Currency, and Savings Calculation.

Load a Roll of Thermal Paper

To load a new roll of thermal paper:

1. Open the paper compartment door (located on the base of the Console, under the display).
2. Slide the door to the right, then lift the printer door up.
3. Insert the end of a new paper roll with the thermal side down, into the paper slot.

To verify which side is the thermal side, scratch the paper with your finger nail. If a black mark appears, this is the thermal side.

4. Extend the end of the paper past the end of the unit.
5. Rotate the printer door down. Make sure you hear it snap into place.
6. Slide the printer door to the left.
7. Tear the excess paper off.

CAUTION! To avoid paper jams, never fold the end of the paper roll or cut it diagonally or to a point.

NOTE: If the paper appears to be stuck in the printer, contact your authorized BladderScan® Service Center, your local BladderScan® distributor, or Verathon Medical® Customer Care at 1.800.331.2313 for service.

Assemble the Medical Cart

NOTE: The Medical Cart is an optional accessory. If you're not using the Medical Cart, please skip to the next section, Install the ScanPoint® with QuickPrint Software, on page 25.

The optional Medical Cart is illustrated in Figure 9.

Figure 9. Medical Cart, PN: 0800-0322



Medical Cart Parts List

Item No.	Quantity	Part Number	Description
1	1	0142-0276	Tray Assembly
2	1	0810-0140	Bracket and Post
3	1	0810-0141	Medical Cart Base
4	4	0261-0107	Screw PH W Lock 25-20 x 1/2
5	1	0260-0357	Fluted Knob 3/8-16 x 1.00
6	4	0810-0142	Caster, 3 inch
7	1	0810-0143	Caster, 3 inch with Brake

To assemble the cart:

While following the assembly procedure, refer to **Figure 10**.

1. Align and press one 3-inch Caster with Brake (Item 7) and four 3-inch Casters (Item 6) into Medical Cart Base (Item 3).
2. Align through round hole in Bracket and Post (Item 2) bracket to through hole in Tray Assembly (Item 1).
3. Insert Bracket and Post (Item 2) into square relief in bottom of Tray Assembly (Item 1).
4. Insert four Screws (Item 4) through Bracket and Post (Item 2) into molded inserts in Tray Assembly (Item 1); tighten securely.
5. Place Tray Assembly with Bracket and Post into Medical Cart Base (Item 3).
6. Place device in foot prints on Tray Assembly (Item 1).
7. Screw the Fluted Knob (Item 5) through Bracket and Post (Item 2) bracket round hole and hand tighten.

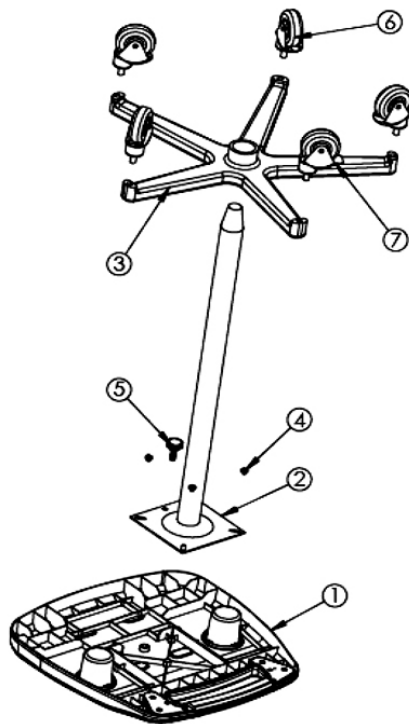
Figure 10. Medical Cart Assembly

To attach the BladderScan® BVI 9600 to the Medical Cart, refer to the instructions on page 25.

Install the BVI 9600 BladderScan® on the Medical Cart (Optional)

Your BladderScan® BVI 9600 is completely portable and can be easily moved and positioned for convenient use. Installing the BVI 9600 on the optional Medical Cart will allow you to move the BladderScan® instrument along with related accessories (spare battery, Sontac® Gel Pads or ultrasound gel, and an extra roll of paper) to the patient examining area or bedside as necessary.

To install the BladderScan® BVI 9600 on the Medical Cart:

NOTE: For cart assembly instructions and parts list, refer to page 23.

To install the BVI 9600 to the Medical Cart, screw the Fluted Knob (Item 5) through Bracket and Post (Item 2) bracket round hole and Tray Assembly (Item 1), and into the mounting hole on the bottom of the device. Hand tighten (Figure 11).



Figure 11. Attaching the BVI 9600 to the Medical Cart

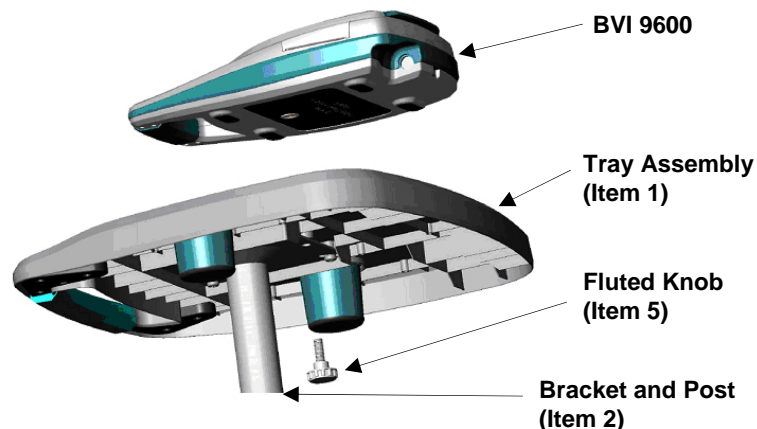

Install the ScanPoint® with QuickPrint Software (Optional)

Optional ScanPoint® with QuickPrint software is designed to mesh seamlessly with your BladderScan® devices. The BVI 9600 automatically downloads exam data to the ScanPoint® host computer via a wireless connection enabled by the battery charger/wireless hub - allowing further viewing, analysis, archiving, and report generation.

To install ScanPoint® with QuickPrint, insert the ScanPoint® with QuickPrint Install CD into your computer's CD drive and follow the on-screen prompts. Please refer to the separate User's Manual provided with ScanPoint® with QuickPrint for complete installation and operating instructions.

Watch the Training Videos

Two training videos provide an overview of how to perform an ultrasound scan of the bladder or the abdominal aorta using the BladderScan® BVI 9600. Each video is approximately 5 minutes long.

- ◆ The Bladder Volume Mode training video is available for review anytime on the BladderScan® BVI 9600 by pushing the  button on the Home screen in either the Bladder Volume or AortaScan™ Modes.
- ◆ Both the Bladder Volume Mode training video and the AortaScan™ Mode training video are available for viewing on the BladderScan® BVI 9600 In-Service CD.

Displays, Controls, and Indicators

Console Displays and Button Functions

This section describes BladderScan® BVI 9600 displays and button functions.

The Console display presents information that varies depending on the current instrument function.

The functions of the five buttons below the display vary according to current instrument mode and function. Button functions are indicated by icons in the display footer, immediately above the each button.

Battery Status Indicator

A battery status indicator appears in the header of all BVI 9600 screens. Depending on current level of battery charge, one of the following symbols will be displayed:



Indicates a fully charged battery.



Indicates a battery 50% to 75% charged.



Indicates a battery 25% to 50% charged.



Indicates a battery that is nearly discharged and can power only a few more scans.



Indicates the battery must be changed.

Home Screen

The Home screen appears when the BVI 9600 is first powered on. The Home screen serves as a starting point for all of the instrument functions.

Depending on instrument mode, either the Bladder Volume Mode home screen (Figure 12) or the AortaScan™ Mode home screen (Figure 13) will appear.

Press the MODE button  to toggle between Bladder Volume and AortaScan™ Modes.

The Bladder Volume Mode home screen displays:

- ◆ A list of saved exam results (10 maximum) saved in chronological order. Yellow folders hold saved exams. Gray folders represent empty spaces still available for saving exam results.
- ◆ A Cost Saving Summary (Bladder Volume Mode only)
Displays the savings to your organization from using the BladderScan® BVI 9600 rather than catheterization. The values used to determine the savings are user-variable and entered from the Savings Preferences Screen (Refer to page 39 for more information about using this screen).

Figure 12. Home Screen: Bladder Volume Mode

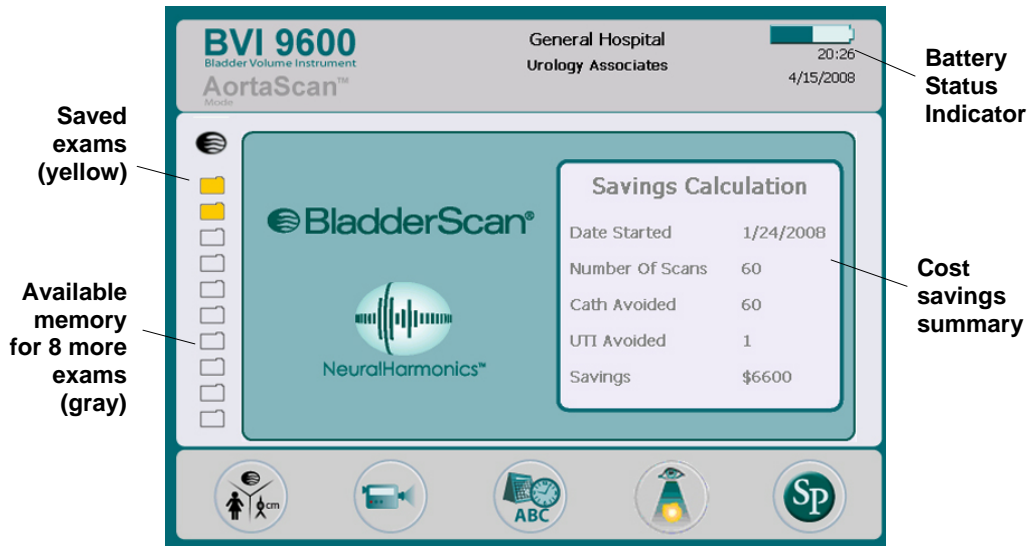
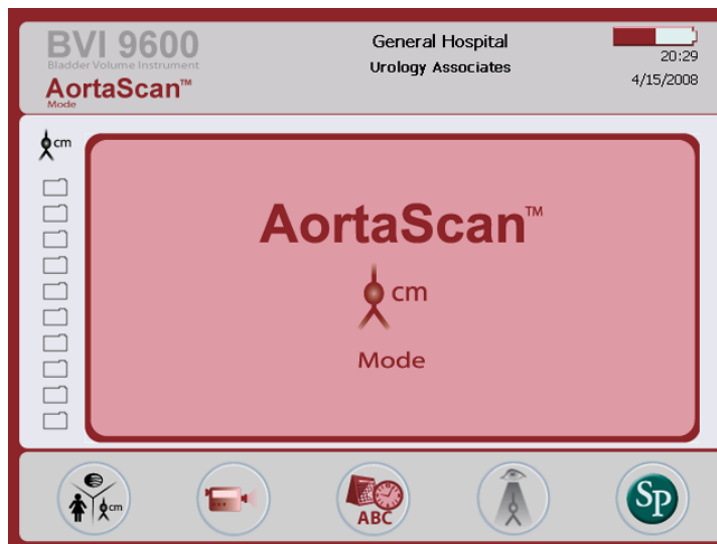







Figure 13. Home Screen: Aorta Scan™ Mode



Home Screen Buttons

Button	Function
	<p>Press repeatedly to cycle through three possible scan options:</p> <ul style="list-style-type: none"> ◆ Take a bladder volume measurement of a female patient who has not had a hysterectomy. (When the female icon is illuminated the BVI9600 will assume the patient has a uterus.) ◆ Take a bladder volume measurement of a male patient, or a female patient who has had a hysterectomy. ◆ AortaScan™ is displayed in the header and the screen is burgundy
	<p>Press to view the training video.</p>
	<p>Go to the Settings screen (set the time, date, institution name, and user preferences).</p>
	<p>Press to review a previously saved exam. (This button will be gray (inactive) if there are no previously saved exams to review.)</p>
	<p>Press to initiate communication with the ScanPoint® host computer. Saved and annotated exams will be automatically uploaded to the host computer. (ScanPoint® software must be previously installed and a connection open. Use of the ScanPoint® software is optional.)</p>

Scan Screen

The Scan screen (Figure 14) appears and displays a progressively updating image of the bladder outline. When the ultrasound measurement is complete, the Results screen opens automatically.

The five buttons below the display do not function during the scan.

Figure 14. Scan Screen

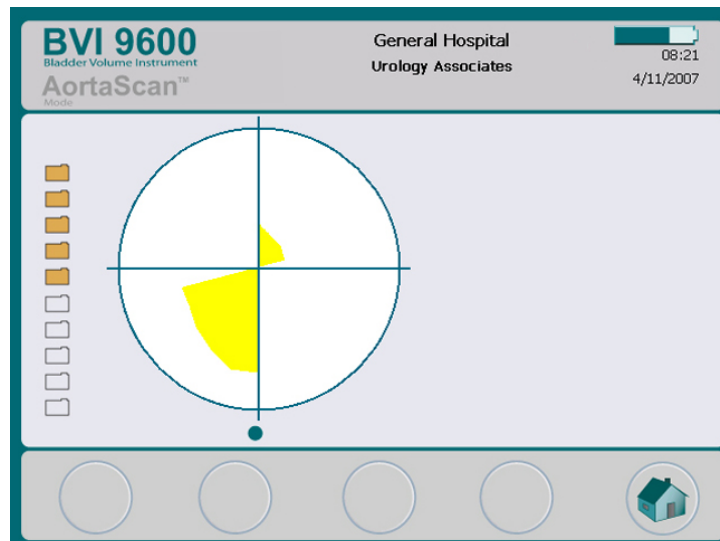

Results Screen



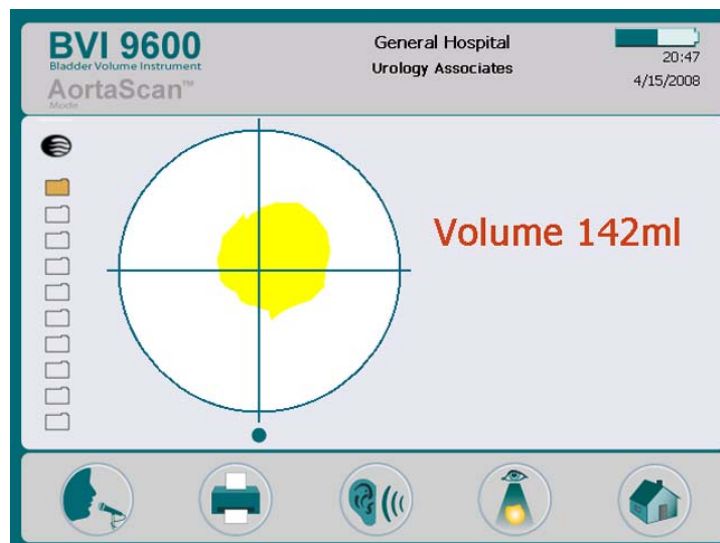

The Results screen (Figure 15) appears automatically when a scan is complete.

The display presents the result of the exam: crosshairs, bladder outline, and the calculated bladder volume. You may choose to print this result to the onboard printer and/or to record a voice annotation to save the exam. After the annotation is recorded, the PLAY and REVIEW buttons become active and the newly recorded exam appears on the main display as an orange folder icon.

Figure 15. Results Screen



Results Screen Buttons

Button	Function
	Press to record a voice annotation (up to 10 seconds long).
	Press to print exam results (Bladder Volume Mode) Activate Manual Measurement Mode (AortaScan™ Mode) - see page 58.
	Press to play a previously recorded voice annotation. If no voice annotations are recorded, this button is disabled.
	Press to go to the review screen. If no voice annotations are recorded, this button is disabled.
	Press to return to the Home screen.

Review Screen



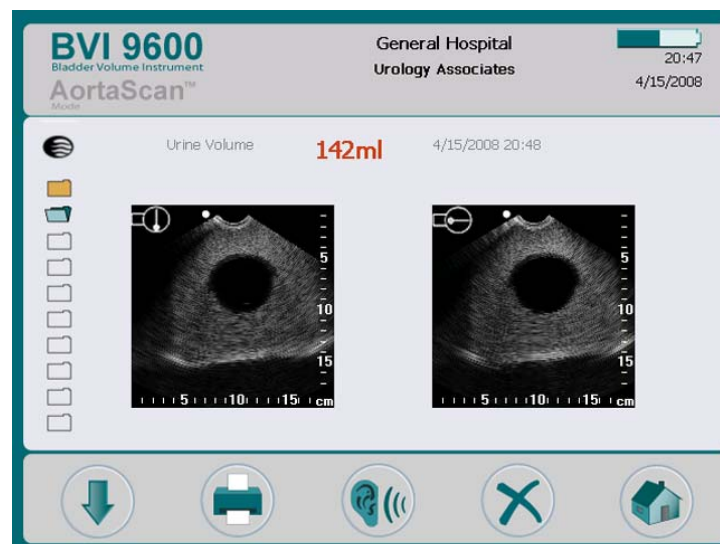

The Review screen (Figure 16) opens when you select a saved exam (yellow folder icon) to review.

The displays shows the ultrasound images associated with the selected exam. A green open-folder icon indicates which exam is being viewed. While reviewing saved exams, the buttons below the display allow you to print, replay, or delete exam data.

Figure 16. Review Screen





Review Screen Buttons

Button	Function
	SELECT: Press to select the next exam in the list.
	PRINT: Press to print the results for the currently selected exam to the onboard label printer. While printing is in progress a flashing print icon appears on the display. The buttons are disabled except SELECT and PLAY.
	PLAY: Press to play a previously recorded voice annotation. If no voice annotations are recorded, this button is disabled.
	DELETE: Press to delete the currently selected exam.
	HOME: Press to return to the Home screen.

Tutorial Screen

To open the Tutorial Screen (Figure 17) press the  button from the Home screen (page 19).







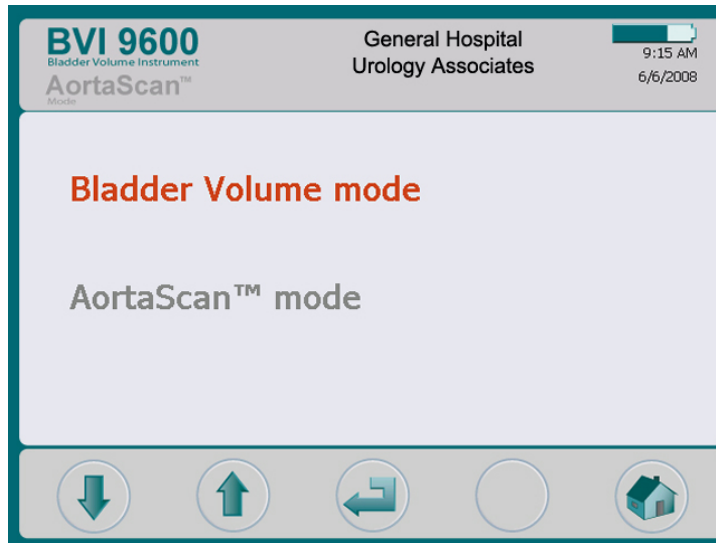

The Tutorial screen presents a menu of training modules. To select a title, press either the  or  button until the desired title is highlighted (red). Press the  button to go to the Video Viewing screen.

NOTE: The SCAN button (on the Probe) is disabled during module playback.

Figure 17. Tutorial Screen



Tutorial Screen Buttons

Button	Function
 	SELECT NEXT: Press to move to next title.
 	SELECT PREVIOUS: Press to move back to previous title.
 	ENTER: Press to begin module playback. While the module is playing, press to pause. Press again to resume play.
-	No function.
 	HOME: Press to return to the Home screen.

Video Viewing Screen

The Video Viewing (Figure 18) screen is activated by pushing the ► button on the Tutorial screen (Figure 17).

NOTE: The SCAN button is disabled during video playback.

Figure 18. Video Viewing Screen



Video Viewing Screen Buttons

Button	Function
-	No function.
	PLAY/PAUSE: Press to start video playback. Press to pause. Press again to resume play.
	BACK: Return to the training titles screen.
-	No function.
	HOME: Press to return to the Home screen.

Settings Screen

To open the Settings screen (Figure 19), push the SETTINGS button  on the Home screen.







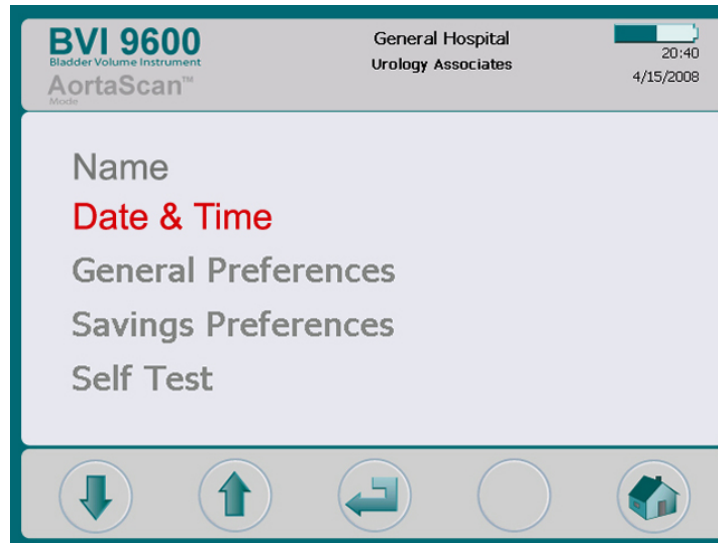

The display presents a list of user-configurable settings: Name, Time & Date, General Preferences, Savings Preferences, and Self-Test. Use the Up/Down arrows to move through the list of options. To select an option, press the ENTER button.

NOTE: When the Settings screens are open, the SCAN button (on the Probe) is disabled.

Figure 19. Settings Screen Start Menu



Settings Screen Buttons

Button	Function
 	SELECT NEXT: Press to select the next setting in the list.
 	SELECT PREVIOUS: Press to select the previous setting in the list.
 	ENTER: Press to select the highlighted setting.
-	No function.
 	HOME: Press to return to the Home screen.







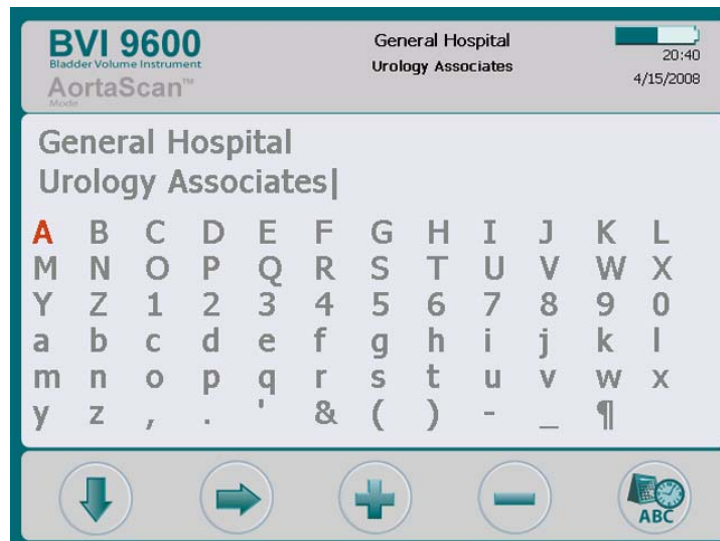



Alpha-Numeric Screen

This screen allows you to select the appropriate alpha-numeric characters for entering your health care institution's name.

Figure 20. Alpha-Numeric Screen



Alpha-Numeric Screen Buttons

Button	Function
 	Press to move down in the grid.
 	Press to move to the right in the grid.
 	Press to add the highlighted character to the name.
 	Press to delete one character from the name.
 	Press to return to the Settings screen.





Date & Time Screen

This screen allows you to adjust the date and time.

NOTE: If the time display is set to show a 24-hour clock, the hour units are 0 - 23. If the clock is set to show a 12-hour clock, the hour units are 1 AM - 12 AM and 1 PM - 12 PM.

Referring to the example shown in Figure 21:

To change the time from 20:42 AM to 23:30 (11:30 PM):

1. Press the  button until the **20** is highlighted (red).
2. Press the  button 3 times until the time digits display **23:30**.
3. Press the  button until the **42** is highlighted.
4. Press the  button repeatedly until the minutes display **30**.

The time setting is now 23:30.







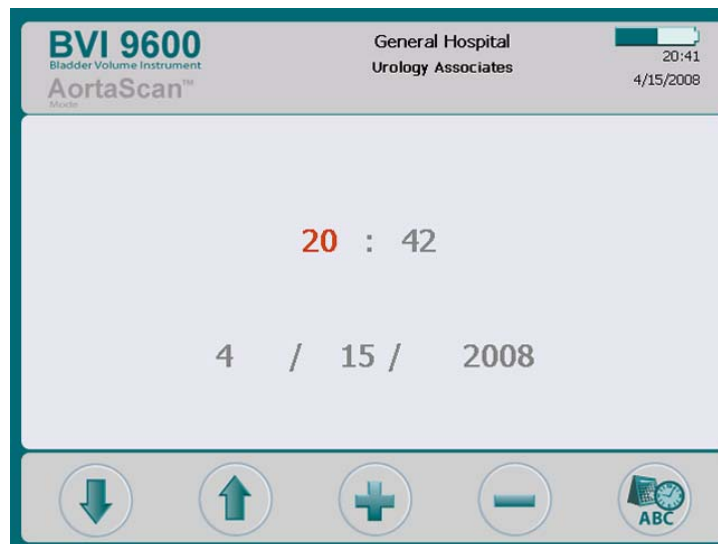

5. Press the SETTINGS button  to save this entry and return to the Settings screen.

Figure 21. Date & Time Screen



Date & Time Screen Buttons

Button	Function
 	Move back one changeable unit.
 	Press to move forward to the next changeable unit (in this case, hours, minutes, AM/PM, month, day, year).
 	Press to add and/or toggle digits as appropriate (hours, minutes, AM/PM, months, day, years). Press and hold the button to move through options more quickly.

Button	Function
	Press to subtract or toggle digits as appropriate (same as above). Press and hold the button to move through options more quickly.
	Press to save the current date/time setting and return to the Settings screen.

General Preferences Screen

This screen displays a list of available settings and their current values.

Available settings:

- ◆ **Language:** English (default), Chinese Traditional, Czech, Danish, Dutch, Finnish, French, German, Greek, Italian, Hungarian, Japanese, Korean, Norwegian, Portuguese (European), Spanish, Swedish, Turkish.
- ◆ **Date Format:** mm/dd/yyyy; dd.mm.yyyy; yyyy-mm-dd.
- ◆ **Time Format:** 12-hour or 24-hour
- ◆ **Calibration Warning:** On (default), Off. When “On” is selected, a calibration warning will appear in the display header when the device requires calibration.
- ◆ **Print Report Type:** Toggle between C-Mode images (bladder in crosshairs) and B-Mode images (image of bladder and abdominal space below Probe, Figure 22).

Figure 22. B-Mode and C-Mode Print Reports

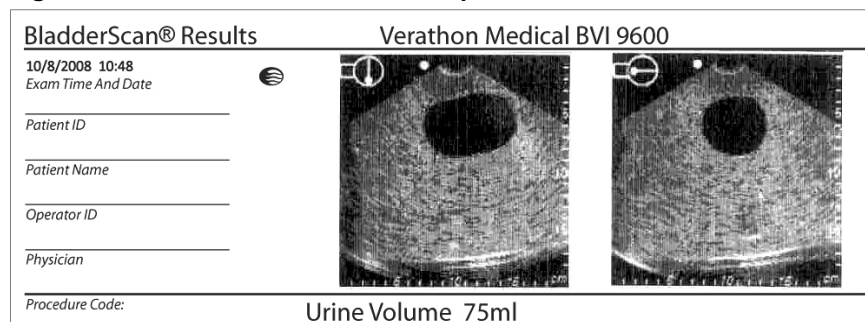

**B-Mode
Print Report**

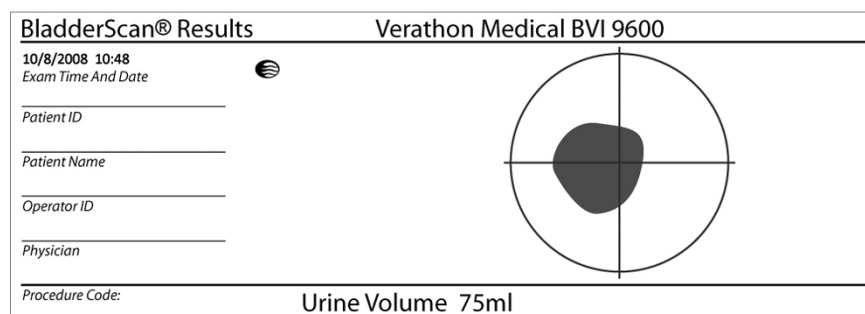











**C-Mode
Print Report**

Figure 23. General Preferences Screen



General Preferences Screen Buttons

Button	Function
 	SELECT PREVIOUS: Press to select the previous setting in the list.
 	SELECT NEXT: Press to select the next setting in the list.
 	For settings with a list of options, press to select the next option.
 	For settings with a list of options, press to select the previous option. Press and hold to move through options more quickly.
 	Press to return to the Settings screen.

Savings Preferences Screen

To open the Savings Preferences screen, select Savings Preferences from the Settings Screen (Figure 19, page 35).

Use this screen to enter base values used to calculate the savings to your organization from using the BladderScan® BVI 9600 rather than catheterization.





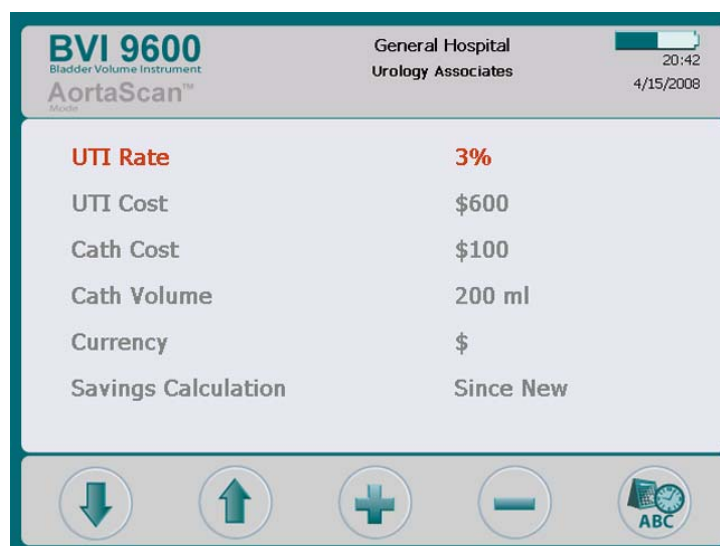

Preferences lists and options:



- ◆ **UTI Rate:** 1% to 100% in increments of 1%
- ◆ **UTI Cost:** \$10 to \$10,000 in increments of \$10
- ◆ **Catheter Cost:** \$1 to \$1000 in increments of \$1
- ◆ **Catheter Volume:** 20 ml to 1000 ml in increments of 20 ml
- ◆ **Currency:** \$ / € / £ / ¥
- ◆ **Saving Calculation:** Since New, Since 1/1/2006, Reset Now, Print Since New, Print Recent, Hide Savings
 - "Reset Now" clears all savings preferences.
 - "Print Since New" or "Print Recent" and then pressing the "Return to Settings" button prints the Savings Calculation data.

Figure 24. Savings Preferences Screen



Savings Preferences Screen Buttons

Button	Function
 	SELECT PREVIOUS: Press to select the previous setting in the list.
 	SELECT NEXT: Press to select the next setting in the list.
 	For settings with a list of options, press to select the next option. Press and hold to move through options more quickly.

Button	Function
	For settings with a list of options, press to select the previous option. Press and hold to move through options more quickly.
	Press to save the current date/time setting and return to the Settings screen.

Self-Test Screen

To open the Self-Test screen, select Self-Test from the Settings menu (Figure 19, page 35). The Self-Test screen will open and testing begins automatically.

Figure 25. Self-Test Screen

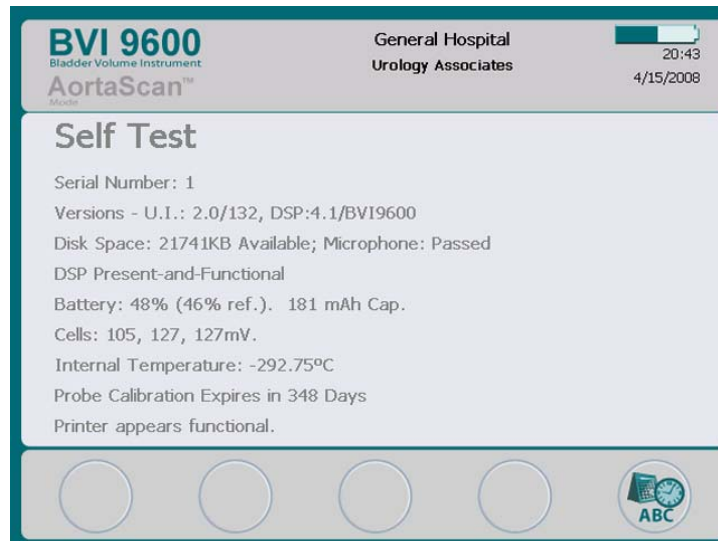

Self-Test Screen Buttons

Button	Function
-	No function
-	No function
-	No function
-	No function.
	Press to return to the Settings screen.

ScanPoint® Screen

NOTE: Only available if optional ScanPoint® software is installed on a PC.





To open the ScanPoint® screen, press  from the Home screen. The ScanPoint® screens display information about the status of the link between the BladderScan® instrument and the ScanPoint® host computer (Figure 26).

Figure 26. ScanPoint® Screens

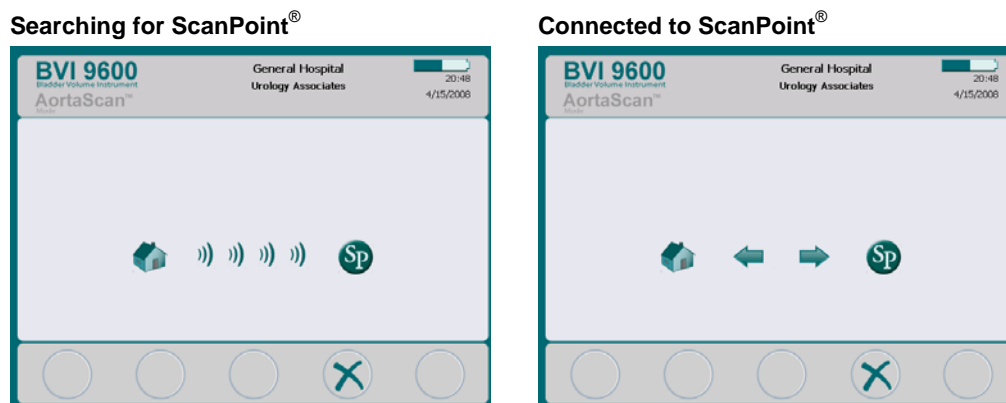

ScanPoint® Screen Buttons

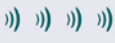
Button	Function
	No function.
	No function.
	No function.
	CANCEL: Cancels the current action and ends communication with ScanPoint®.
-	No function.

Sleep Mode

The Sleep Mode helps preserve battery power. After four minutes of idle time, a Sleep Mode alert message displays for 15 seconds (Figure 27). While the message is displayed, press any button to keep the Console awake and dismiss the message. After 15 seconds, the Console goes to sleep. To wake the instrument from sleep, simply press the Power button.

Figure 27. Sleep Mode Screen

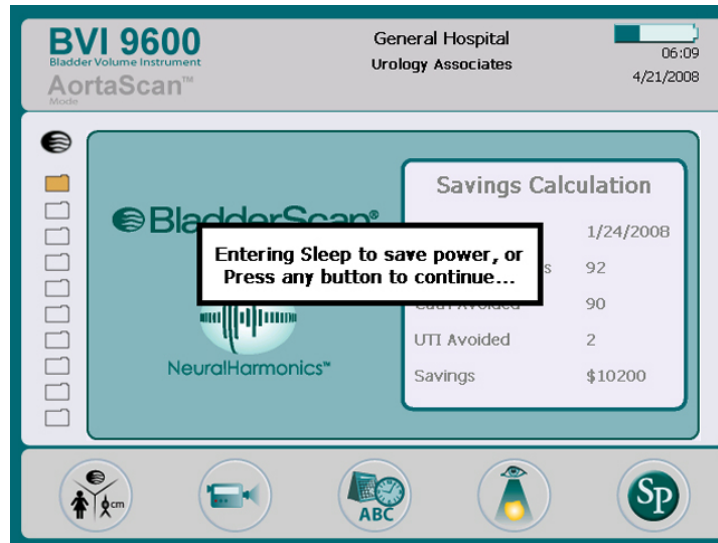

Memory Optimization During Power Down

When the power is turned off, the BladderScan® BVI 9600 begins an internal process of memory optimization. This process takes several minutes. When complete, the device will shut down. An alert appears on the display during the memory optimization process (Figure 28).

Figure 28. Memory Optimization Alert

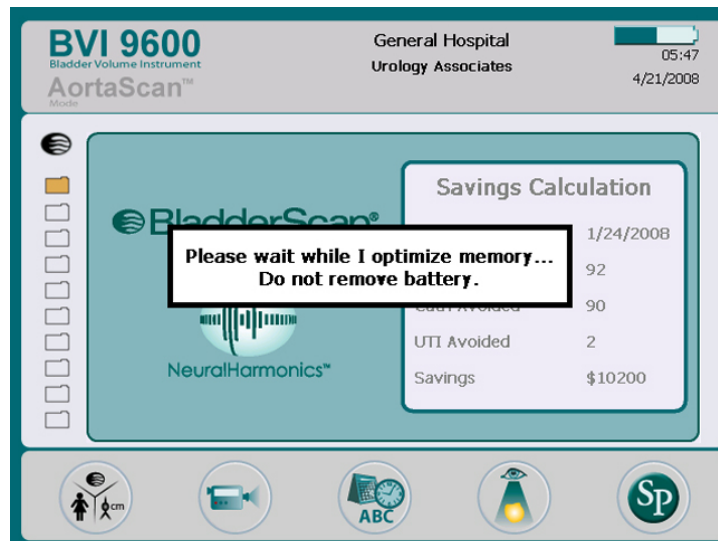

NOTE: DO NOT remove the battery until the device shuts down completely. Replacing the battery while memory is being optimized might disable the instrument as program and exam files might not be rewritten properly.

Measuring Bladder Volume

Preparing for the Exam

Before You Begin the Exam:

- ◆ Make sure you are familiar with the parts of the BladderScan® instrument (see *Introducing the BladderScan® BVI 9600* on page 13).
- ◆ If you are a new BladderScan® instrument user, Verathon® recommends that you perform your first exam on a patient with a moderately full bladder, rather than initially attempting to locate and scan a nearly empty bladder.
- ◆ Check the instrument's battery icon to make sure the battery has sufficient power.

NOTE: If the battery icon is 1/4 or less full, replace the battery with a freshly charged battery before proceeding. Place the discharged battery in the battery charger to recharge.

- ◆ Clean and disinfect the Probe by wiping it gently with a soft cloth soaked in isopropyl alcohol.

Be aware of the following conditions the patient may have that could affect ultrasound transmission and the accuracy of your exam:

- ◆ A catheter in the patient's bladder. The presence of a catheter may affect the accuracy of the bladder volume measurement, but the measurement may still be clinically useful (detecting a blocked catheter, for example).
- ◆ Previous suprapubic or pelvic surgery. Scar tissue, surgical incisions, sutures, and staples can affect ultrasound transmission and reflection.

Do not use the BVI 9600 on:

- ◆ Patients with ascites
- ◆ Patients with open skin or wounds in the suprapubic region.
- ◆ Pregnant patients

Measuring Bladder Volume

1. **Turn on the BladderScan® BVI 9600.**
Turn on the BladderScan® BVI 9600 by pressing the ON/OFF button.



2. **Select the exam mode.**



Press the MODE button repeatedly to toggle between Bladder Volume or AortaScan™ Modes and to display or clear the female icon.

When the female icon is displayed, the device assumes the patient is a female who has not had a hysterectomy.



Select to measure bladder volume on male patients, or female patients who have had a hysterectomy.

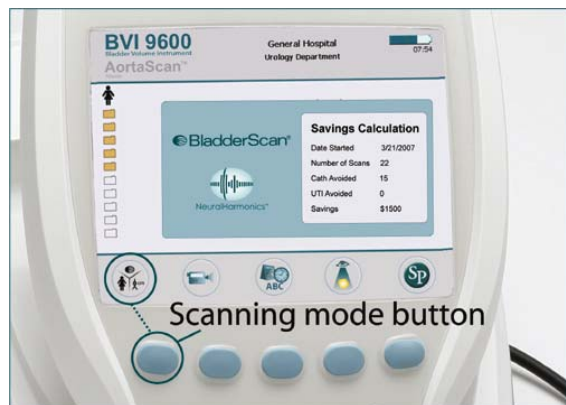

3. **With the patient supine apply gel.**
Have the patient lie in the supine position with the abdominal muscles relaxed.

Palpate the patient's symphysis pubis (pubic bone). Place an ample quantity of gel (with as few air bubbles as possible) midline on the patient's abdomen, approximately one inch (3 cm) above the symphysis pubis (pubic bone).



4. **Aim toward the bladder.**
Standing at the patient's right side, place the Probe on the gel and aim it toward the expected location of the bladder. For most patients, this means angling the Probe slightly toward the patient's coccyx (tail bone) so the scan clears the pubic bone.

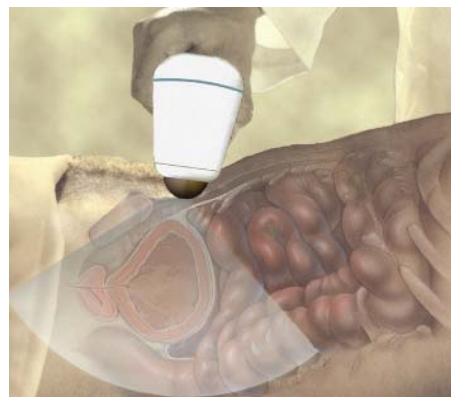

5. **Press and release the SCAN button.**
Press and release the SCAN button, located on the underside of the Probe. As the scan progresses, sections of the bladder will appear on the Console screen. When you hear the end-scan tone, the scan is complete.

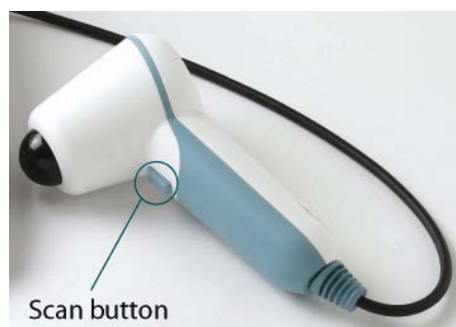

6. **Verify the scan.**
If the scan is "on target" the Probe will display eight arrows. On the Console display, the bladder cavity will appear in the center of the crosshairs.



6a. Re-aiming.

If the scan is “off-target” the Probe will show an arrow indicating the direction to move the Probe to be “on target.” If the arrow is solid, it means you are slightly “off target” and must re-aim and re-scan. On the Console, the bladder will not be in the crosshairs, and there will be an arrow pointing in the direction for re-aiming.

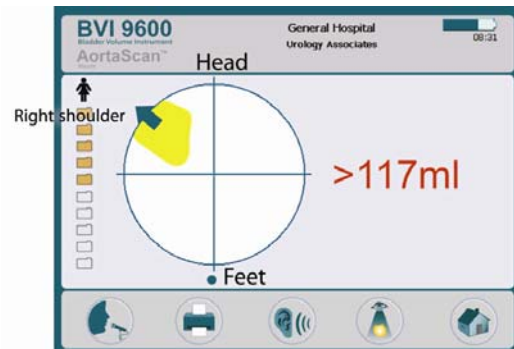
**6b. To re-aim:**

Note that the crosshairs correspond to the anatomy of the patient as follows:

- ◆ The small dot at the base of the crosshairs represents the feet of the patient.
- ◆ The top of the crosshairs represents the patient’s head.
- ◆ The upper left quadrant represents the patient’s right shoulder.

This orientation should help you in re-aiming the Probe to capture the complete bladder fully in the ultrasound cone.

6c. Pubic Bone.

You may also see a display indicating that the pubic bone is inside the ultrasound cone. If this occurs, you may want to re-aim and re-scan. Although the bladder may be shown as centered in the ultrasound cone, and your measurement may be complete, there is a possibility that the pubic bone is obscuring part of the bladder. By re-aiming and re-scanning you can ensure you have captured the bladder fully inside the ultrasound cone.

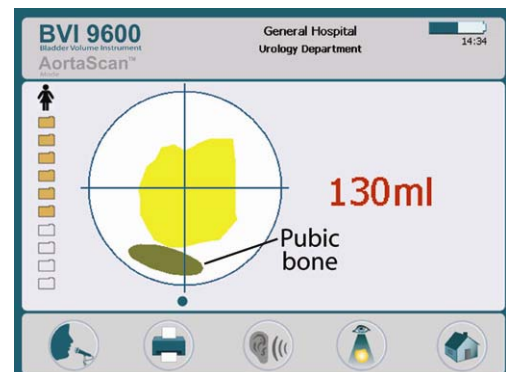

- 6d.** If the bladder volume is greater than 999 ml, the display shows > 999 ml

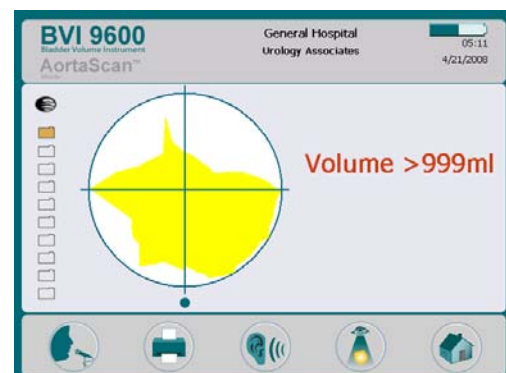

7. Save, review, and print exam results.

- ◆ **To save the exam** you must annotate it.
- ◆ **To annotate**, press and release the RECORD button on the Console. When you see the RECORD button icon change to a STOP button icon, record the patient information by speaking into the Probe microphone. When the hourglass icon disappears, press the LISTEN button to replay the annotation.
- ◆ **To review** the scan images, press the REVIEW button. (You must first save the exam before you can review it.) On the review screen, the user can review all currently saved exams and can print, replay voice annotations, or delete exams.
- ◆ **To print** exam results via the on-board printer, press the PRINT button.
- ◆ **To perform** another exam, press the HOME button.

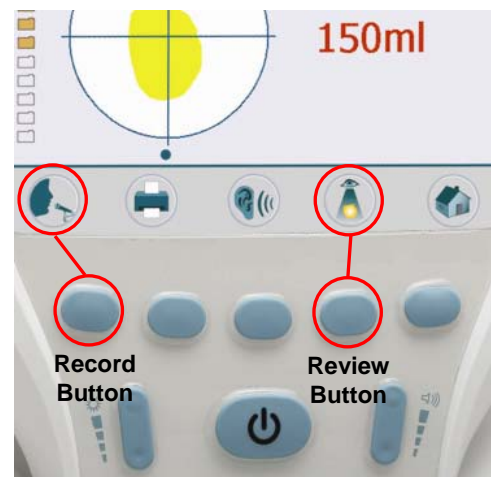

8. Finish the exam.

Once you have completed the scan, wipe the ultrasound gel off the patient and the Probe. For ScanPoint® subscribers, logging onto ScanPoint® automatically transfers and saves your annotated exams to your Windows® computer.

Additional Scanning Tips

Applying too much pressure when scanning will lead to a Greater Than (>) symbol preceding the measurement on the screen. Apply less pressure and re-scan.

Hold the device steady while scanning. Movement will result in an inaccurate reading.

Volume reading will be affected by:

- ◆ The presence of scar tissue
- ◆ The presence of a catheter
- ◆ Overly obese patients:

With obese patients, lift as much abdominal adipose tissue out of the way of the

instrument as possible. Apply more pressure to the BladderScan® BVI 9600 instrument to reduce the amount of adipose tissue through which the ultrasound must pass.

To ensure accurate results, make sure that:

- ◆ There are no air gaps between the Probe and the patient's skin.
- ◆ The gel pad is intact (not broken or cracked).
- ◆ There are no air bubbles under the gel pad.
- ◆ You are holding the instrument steady while scanning (avoid changing its position, angle, or pressure).
- ◆ You are using enough pressure to maintain good skin contact until the scan is complete.
- ◆ There is not a catheter in the patient's bladder. The presence of a catheter may affect the accuracy of the bladder volume measurement, but the measurement may still be clinically useful (detecting a blocked catheter, for example).

NOTE: The BVI 9600 is able to scan rapidly and repeatedly throughout the day. If however scans are taken quickly, in rapid succession, over a 30 minute period, some slowing in performance may be noticed. While this may occur rarely, it is normal for the instrument.

Recording a Voice Annotation

After performing an exam, you can record additional information about a patient to be stored with the exam results.

The instrument can store ten scans with voice annotations, so you can perform multiple exams on your rounds. If you are using the optional ScanPoint® with QuickPrint software, you can upload saved exams to your PC. (Refer to the ScanPoint® with QuickPrint User's Manual for more information.)

To record a voice annotation:

1. Press the RECORD button (microphone). A STOP button is now displayed.
2. The microphone is located just above the aiming display on the Probe. Hold the microphone approximately 6 inches (15 cm) from your mouth when you are recording the annotation, and speak clearly.

Be sure to include all relevant exam information, including the patient's name and the name of the person performing the exam.



3. When you have finished your annotation, press the STOP button. An hourglass icon will be displayed while your annotation and exam are updated and stored. After the annotation has been saved, to listen to your annotation, press the LISTEN button.



If you are not satisfied with the recording, press RECORD again to record a new annotation.

IMPORTANT!

- ◆ If you do not record a voice annotation for a particular exam, that exam will be lost and the next exam you perform will overwrite the non-annotated one.
 - ◆ If the instrument battery runs low or the instrument goes into sleep mode, any non-annotated exam data is lost. However, the instrument does not erase any annotated exam results when it goes into sleep mode. To make sure you do not lose any patient data, it is a good idea to add a voice annotation to every patient exam.
 - ◆ You can make a new recording only if the instrument still displays the bladder volume for that particular exam.
4. When you are satisfied with your recording, wait while the instrument automatically accepts and stores the recording with the exam results. The volume displayed on the LCD screen disappears, and the instrument is ready to perform another measurement.
 5. If you are using the BVI 9600 in conjunction with the optional ScanPoint® with QuickPrint software, you can view exam results and annotations on your Windows® PC. Please refer to the ScanPoint® with QuickPrint User's Manual for more information.

Deleting a Saved Exam

Saved exams are indicated by yellow folder icons along the left edge of the display. To delete a saved exam:

1. Open the Review Screen. (From the Home Screen press )
2. Press the  button until the desired exam is highlighted (blue).
3. Press the  button to delete the exam.

Printing

You can use the BladderScan® BVI 9600 onboard printer to print the ultrasound images captured during the scan (Figure 29 is an example).

To print exam results, you must first record a voice annotation as described previously. When this is complete, press the PRINT button.

Adding Additional Information

The label provides fields for Patient ID, Patient Name, Operator, and Physician. This information must be entered manually.

Figure 29. Exam Results Printout Using the Onboard Printer

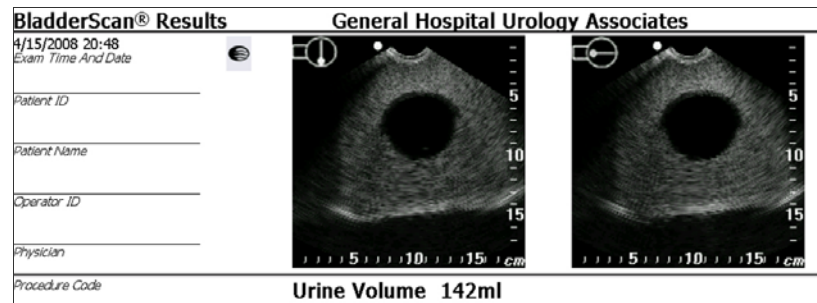

NOTE: If the facility name, date, and time have not been set, those lines will be skipped on the printout.

The BVI 9600 prints on thermal paper, which fades over time. For maximum storage life, Verathon® recommends that you photocopy the printout.

Histogram of Cost Savings

Each volume measurement from a completed scanning procedure is stored in the memory of the BladderScan® BVI 9600 in one of eleven volume ranges (each with a 100 ml increment). This data is analyzed and can be displayed on the BVI 9600 at any time. The cost savings screen lists: Date Started, Number of Scans, Cath Avoided, UTI Avoided, Savings.

Cost Savings Criteria

Cost savings are based on the following criteria:

- ♦ **Catheterizations avoided:** Urinary catheterization may be unnecessary. Thus, by using the BVI 9600, these catheterizations are avoided. The default setting (for volume below which catheterization is unnecessary) is 200 ml.
- ♦ **UTIs avoided:** Studies indicate that a certain percentage of unnecessary catheterizations lead to urinary tract infections (UTIs).

By avoiding unnecessary catheterizations, the resulting UTIs are thereby avoided. The default setting (for percent of catheterizations leading to UTIs) is 3%.

- ♦ **Associated UTI costs:** Literature suggests that the additional costs associated with treating UTIs amounts to \$680.00 per patient infection. The default setting is \$680.00.
- ♦ **Cost of catheter kits:** The default setting is \$3.00 per kit.
- ♦ **Total Cost Savings from Using the BVI 9600 =**
(Catheterizations avoided x catheter costs) + (UTIs avoided x UTI costs)

NOTE: The default settings can be changed to reflect the rates and costs at your facility by selecting from the Home screen:  (SETTINGS) > SAVINGS PREFERENCES. See page 39, *Savings Preferences Screen* for more information on customizing Savings Preferences.

Measuring Abdominal Aortic Diameter with AortaScan™ Mode

Introduction

The BladderScan® BVI 9600 features AortaScan™ Mode, which provides the capability to measure abdominal aortic diameter using noninvasive ultrasound. Ultrasound may be preferred as the initial imaging modality for measuring abdominal aortic diameter due to its portability, availability, lack of ionizing radiation, and cost when compared to other alternatives like CT, CTA, MRI or MRA.

The output of the BVI 9600 device in AortaScan™ Mode provides two images as shown in Figure 30 below: an Aiming Display on the left and a Results image on the right. The BVI 9600 also displays the calculated diameter of the aorta in centimeters (cm) below the Aiming Display.

Figure 30. BVI 9600 AortaScan™ Display.

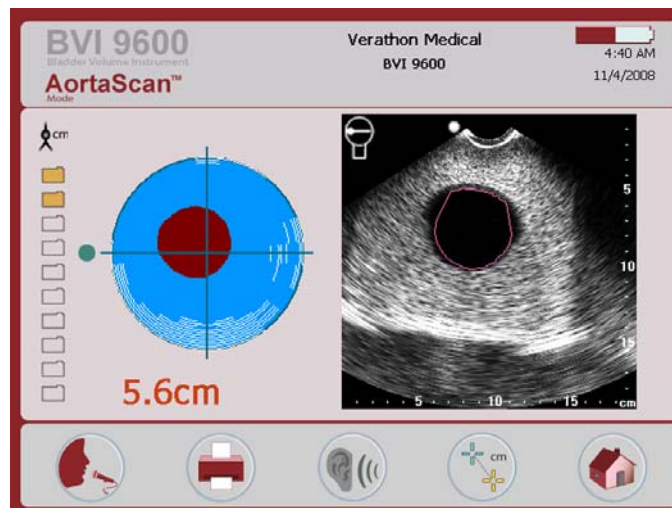

Aiming Display

The Aiming display illustrates the location of the aorta relative to the ultrasound Probe. The center of the two axes represents the center of the Probe. The aorta is shown in red. The white lines represent areas of high reflection, most likely caused by bowel gas.

When aiming, the goal is to angle the Probe so that the aorta in red is not intersecting any white lines (bowel gas) on the Aiming display. Arrows will appear indicating the direction the Probe needs to move in order to produce a better scan.

Results Display

The Results display provides an image of the cross section of the abdominal space below the Probe. Both axes of the image are in centimeters. The abdominal aorta is seen as a

dark circular shadow with a red outline amidst the black and white “speckling” of the ultrasound image.

Preparing for the Exam

Before You Begin the Exam

Take the following steps before beginning a measurement of the aortic diameter:

- ♦ Make sure you are familiar with the parts of the BladderScan® instrument (see *Introducing the BladderScan® BVI 9600* on page 19).
- ♦ Check the instrument battery icon to ensure the battery has sufficient power.

NOTE: If the battery icon is 1/4 full or less, replace the battery with a freshly charged battery before proceeding. Place the discharged battery in the battery charger to recharge.

- ♦ Clean the Probe by wiping it gently with a soft cloth soaked in isopropyl alcohol.

Be aware of the following conditions that the patient may have that could affect ultrasound transmission and the accuracy of your exam:

- ♦ Bowel gas is a common problem for abdominal ultrasound measurement and results in unreadable exams. To avoid bowel gas obstruction of the ultrasound, have patients fast for 12 hours prior to the exam.
- ♦ Previous abdominal surgery. Scar tissue, surgical incisions, sutures and staples can affect ultrasound transmission and reflection.

Do not use the BVI 9600 on:

- ♦ Patients with ascites
- ♦ Patients with open skin or wounds in the abdominal area
- ♦ Pregnant patients

NOTE: The BVI 9600 is not intended for use on acute events such as aortic dissection, ulcer or rupture.

NOTE: Visual verification that the aorta position is fully within the scan cone on the displayed images is important while in the AortaScan™ Mode.

Measuring Abdominal Aortic Diameter

1. Turn on the BVI 9600.

Turn on the BladderScan® BVI 9600 by pressing the ON/OFF button.



Press the MODE button until the AortaScan™ home screen appears.



2. With the patient supine, identify four equally spaced scan locations between the xiphoid process and the umbilicus.

Of the four aortic diameter measurements to be taken, the largest diameter should be used by the physician for determining whether the patient may have an aneurysm in the abdominal aorta.

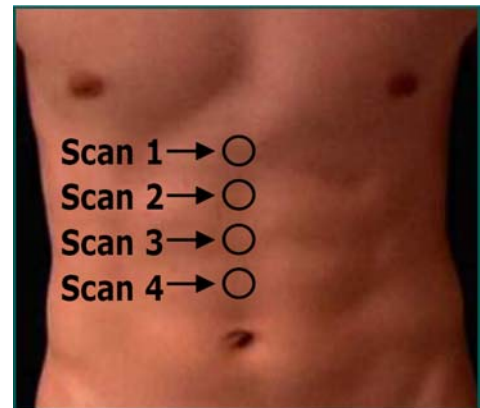

3. Scan the abdominal aorta.

Standing at the patient's right side, place the Probe on the gel at the first position and hold it in position with the Probe screen facing vertically.

Hold the Probe with the long axis aligned with the midline of the abdomen. DO NOT hold the Probe with the handle pointing to either side of the patient.

Press and release the scan button located at the underside of the Probe. As the scan progresses, the cross-section of the aorta will appear on the Console screen. When you hear the end-scan tone, the scan is complete.

See step 6 to annotate and save the scan.

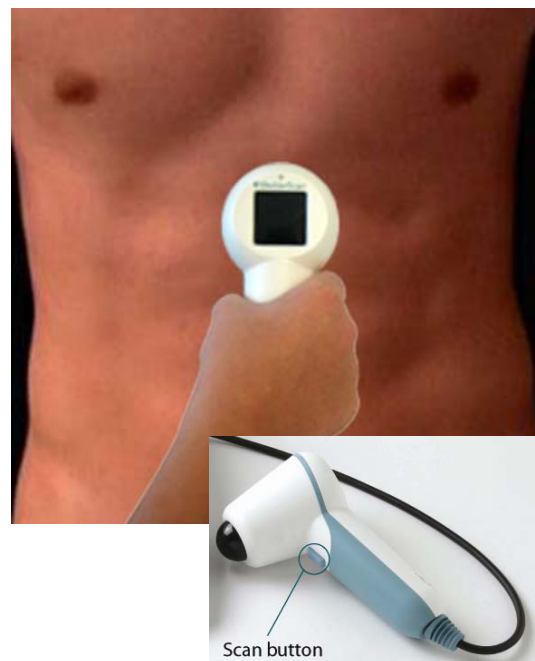

4. Interpreting the Scan - Conditions Affecting Scan Accuracy

An unobstructed scan has been achieved when the Probe displays eight solid green arrows.

When the scan is completed, AortaScan™ mode shows the aortic diameter and two displays on the Console screen.

The Aiming display on the left side of the screen shows the location of the aorta relative to the Probe, as viewed looking from the Probe into the body. The aorta is shown in red and bowel gas is shown as white lines. The green dot on the left side is the reference mark correlating the Aiming display with the Results display on the right side of the screen.

The Results display is a cross-section of the abdomen below the Probe. The abdominal aorta is shown as a dark circular shadow with a red outline. The white dot on the image is a reference mark correlating the Results display with the Aiming display.

When aiming, position the Probe so that the image of the aorta on the Aiming display does not intersect with bowel gas.

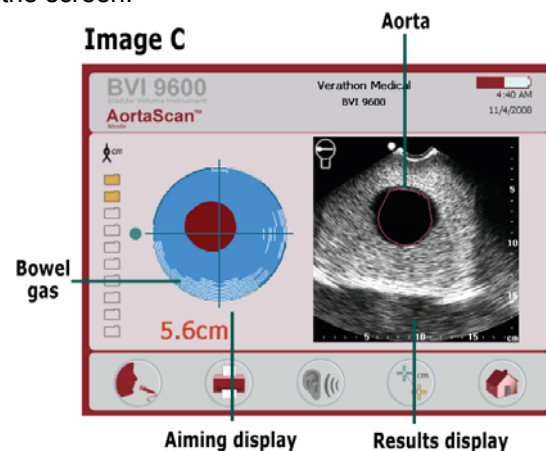

Measuring Aortic Diameters < 3 cm

AortaScan™ mode can detect aortas with diameters between 3 cm and 12.4 cm. Aortas with diameters less than 3 cm will occur in patients who have normally-sized aortas.

The round shadow at 6 cm depth in the Results display is the patient's abdominal aorta. Patients with aortas less than 3 cm in diameter will show no red outline around the aorta in the Results display, as the diameter cannot be measured automatically. Diameter can be estimated, however, using Manual Measurement Mode (page 58).

The "speckled" look to the Results display indicates the ultrasound signal was not blocked by bowel gas. The clearly visible aorta and the lack of any arrows telling the user to re-aim the Probe mean the user can feel confident that the lack of diameter information is due to a small aorta and not due to the presence of bowel gas. In this case, the aortic diameter measurement is valid.

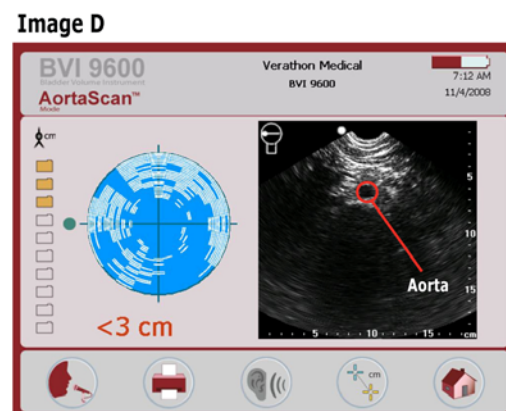

Partial Gas Obstruction

In some cases, gas or air bubbles may be present but do not block the aorta entirely. In such cases, diameter measurements are still calculated, but they are not accurate.

A green arrow on the Console and a solid green arrow on the Probe indicate the abdominal aorta can be detected, but the presence of bowel gas prevents an accurate measurement.

Moving the Probe 1/2 to 1 inch (1 to 2 cm) in the direction of the arrow has a high probability of providing a successful scan.

In this case, the Probe should be repositioned and the patient rescanned. Gently but firmly work the Probe into the tissues of the abdomen with a side-to-side rocking motion to try and displace any bowel gas obscuring the aorta.

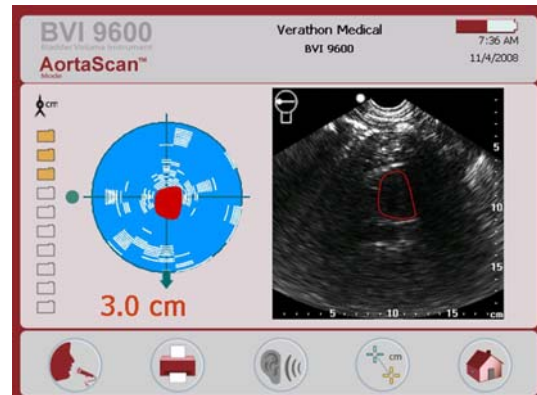

Substantial Gas Obstruction

A substantial amount of gas in the abdomen can block ultrasound from reaching the aorta and results in an unreadable or inaccurate scan.

A red arrow on the Console and a flashing green arrow on the Probe indicate bowel gas has substantially obscured the aorta. No diameter measurement can be calculated and the Results display shows a diameter of < 3 cm, meaning the aorta was not detected.

Although moving the Probe 1/2 to 1 inch (1 to 2 cm) in the direction of the arrow has a low probability of providing a successful scan, an additional scan should be attempted. In this case, the Probe should be repositioned and the patient rescanned. Gently but firmly work the Probe into the tissues of the abdomen with a side-to-side rocking motion to try and displace any bowel gas obscuring the aorta.

If rescanning is not successful, the exam should be postponed and rescheduled. Have the patient fast for 12 hours prior to the exam.



Obesity

Attenuation of the ultrasound signal by excess abdominal fat can result in a poor ultrasound image, which affects the quality of the diameter measurement.

With obese patients, try pressing the Probe firmly into the abdomen to reduce the distance to the aorta as much as possible, while attempting to minimize patient discomfort.

In rare cases, it is possible for a patient's abdomen to be too thick for the ultrasound to reach the aorta. The depth of the ultrasound beam is 18 cm. If a patient has an extra thick abdomen where the distance from the Probe face to the aorta is greater than 18 cm, the BVI 9600 will not detect the aorta.

In these cases, other imaging methods should be used.

5. Manual measurement of aortic diameter (Optional).

Should the user desire, manual measurement of the diameter of the aorta is permitted.

To measure aortic diameter manually:

- After completing the scan, activate Manual Measurement Mode. 
- Use the Axis Select icon to select either the "Up-Down" or "Left-Right" axis of movement for the highlighted cursor.
- Move the highlighted cursor to the edge of the aortic cross-section shown in the Results display.
- Select the other cursor using the Cursor Select icon.
- Move the second cursor on to the opposite edge of the aorta.
- Press the Return icon to save the measurement and exit Manual Measurement mode.

Image G

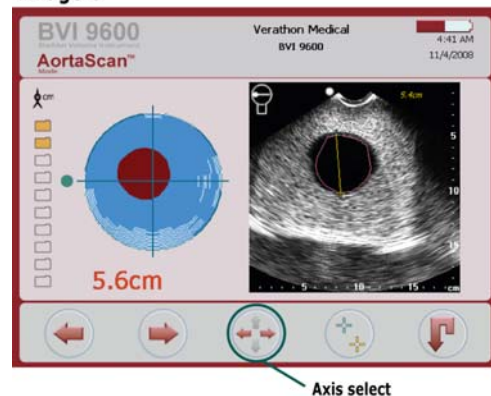
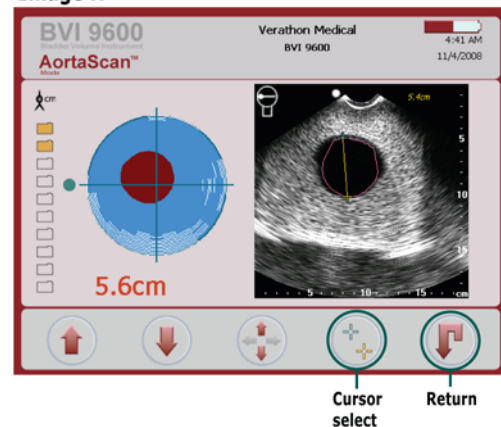

Image H



6. Save, review and print exam results.

To save the exam: You must create a voice annotation. The BVI 9600 does NOT automatically save each scan. It is recommended that the user adds a voice annotation or writes down the diameter calculated for each location.

To annotate the exam: Press the RECORD button on the Console. When the RECORD button icon changes to a STOP button icon, record the patient information by speaking into the Probe microphone. Press STOP when finished. When the hourglass icon disappears, press the REVIEW button to replay the annotation.

To print exam results via the onboard printer, press the REVIEW button, then the PRINT button.

On the Review Screen, two types of diameter measurements may be displayed:

- ◆ Diameter_{V-mode} – Diameter measured automatically by BVI 9600
- ◆ Diameter_{Manual} – Diameter measured manually in Manual Measurement Mode

Diameter_{Manual} will only be displayed if a manual measurement was made.

To perform another exam: Press the HOME button.

7. Scan the aorta at the remaining three locations.

Repeat steps 3, 4, and 6 at three more locations spaced at equal distance between the xiphoid process and the umbilicus.

The largest aortic diameter measured should be used by the physician to help determine if the patient has an aneurysm in the abdominal aorta.

8. Finish the exam.

Once you have completed the exam, wipe the ultrasound gel off the patient and Probe. For ScanPoint® subscribers, logging onto ScanPoint® automatically transfers and saves your annotated exams to your Windows® computer.

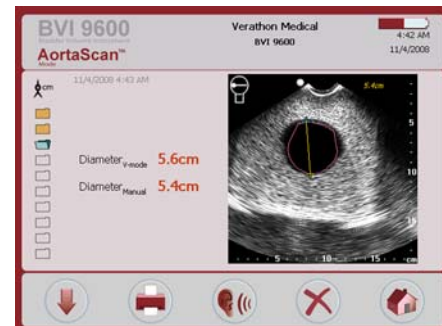

Cleaning and Maintenance

Cleaning the BladderScan® BVI 9600

To Clean the BladderScan® BVI 9600:

1. Use a soft cloth dampened with isopropyl alcohol (or an appropriate hospital cleaning agent) to wipe the Probe until it is thoroughly cleaned.
2. If you use a detergent solution to clean the instrument, remove all residual detergent. Dry the instrument with a clean, soft cloth.
3. Alternatively, dampen a soft cloth in any glutaraldehyde-based hospital disinfectant solution such as Cidex® or Cidex 7® from Advanced Sterilization Products, or Sporocidin® from Sporocidin International. Wipe the instrument with the dampened cloth.
4. To remove all traces of disinfectant solution, wipe the instrument with a clean soft cloth dampened in sterile water or cleaning solution. Verathon® recommends wiping the device three separate times to remove all residual disinfectant.
5. Thoroughly dry the instrument with a clean, soft cloth before using.

IMPORTANT! Failure to heed the following warnings may cause device damage not covered by the BladderScan® BVI 9600 warranty.

- ◆ Do not immerse the instrument in disinfectant solution.
- ◆ Do not use CidexPlus® to disinfect the instrument. CidexPlus will damage the plastic enclosure.
- ◆ Do not subject any part of the instrument to steam sterilization or ethylene oxide sterilization.
- ◆ Changing gel pads between patients is strongly recommended.

Regular Inspections and Maintenance

Verathon Medical® recommends that the BVI 9600 be certified by an authorized BladderScan® Service Center once a year. Certification service includes comprehensive inspection and testing of the instrument to ensure accurate performance in clinical use. For more information, please contact your authorized BladderScan® Service Center, your local BladderScan® distributor, or Verathon Medical® Customer Care Department at 1.800.331.2313 (North America only). International customers, please refer to the contact information on page 68).

NOTE: ScanPoint® Online customers can maintain device certification via the Internet by accessing their ScanPoint® account. For more information about using ScanPoint® Online, please refer to the ScanPoint® with QuickPrint User's Manual.







Weekly Inspections

Once a week, you should inspect the Probe and cable for physical faults or cracks. Cracks that allow the ingress of fluid may affect the performance of the instrument. Any apparent cracks or faults in the Console, Probe, or the cable that links the Console and the Probe, must be referred to your authorized BladderScan® Service Center, your local BladderScan® distributor, your local Verathon Medical® representative, or the Verathon Medical® Customer Care Department.

IMPORTANT! If you see any physical faults or cracks in the instrument, discontinue use immediately and contact your local Verathon Medical® representative or the Verathon Medical® Customer Care Department at 1.800.331.2313.

Using the Built-in Self-Test Utility

The BVI 9600 can perform a number of self-diagnostic tests. To access the Self-Test utility:

1. From the Home screen, press the SETTINGS button: 
2. When the Settings screen opens, press the  or  buttons until SELF-TEST is highlighted (red), then press  to open the Self-Test screen.
3. When the Self-Test screen opens, testing begins automatically with the display providing status and results.
4. When test is complete, press the SETTINGS button  to return to the Settings screen, then press the HOME button  to return to the Home screen.
5. If any test results were failed or abnormal, contact your authorized BladderScan® representative, or contact the Verathon Medical® Customer Care Department at 1.800.331.2313.

Calibrating the BladderScan® BVI 9600 Using ScanPoint® Technology

The BladderScan® BVI 9600 must be periodically calibrated to ensure that the instrument is providing the most accurate results. Calibrating ensures accurate and proper alignment of the instrument's internal coordinate system. If you do not perform the calibration by the prescribed date, the instrument can still be used to take scans but measurements may be compromised.

When calibration is required, a warning appears in the display header (Figure 31).

Figure 31. Calibration Warning

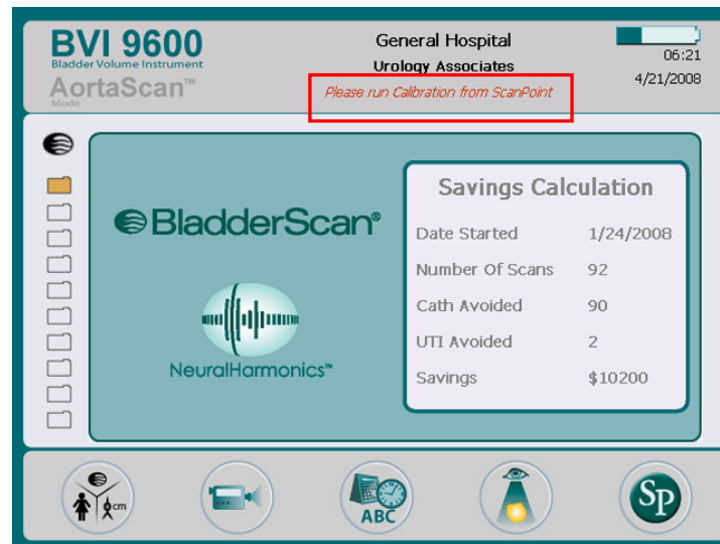

If you do not have ScanPoint® with QuickPrint, you must send your instrument in to an authorized Verathon® service center for calibration. Contact your Verathon® Medical Customer Care Center for more information. For contact information, please see Contacting Verathon® on page 68.

Self-Calibration

Self-calibration requires the ScanPoint® with QuickPrint System and a Calibration Kit (P/N 0620-0340). For instructions on software requirements and installation, please refer to the ScanPoint® with QuickPrint User's Manual.

The entire calibration process takes approximately 15 minutes. ScanPoint® Online plans allow for calibration of the instrument as often as you like. You do not need to wait until the next scheduled calibration date. However, at a minimum, you must calibrate the instrument once every 12 months.

Device Repair

The BladderScan® BVI 9600 Console, Probe, and battery charger/wireless hub are completely sealed. There are no user-serviceable components. Verathon® does not make available any type of circuit diagrams, component parts lists, descriptions, or other information that would be required for repairing the device and related accessories.

Premium Warranty customers have access to a loaner replacement unit and free shipping options which vary according to plan.

If you have any questions, contact your local Verathon Medical® representative or the Verathon Medical® Customer Care Department at 1.800.331.2313.

Unit Disposal

The BladderScan® BVI 9600 and related devices may contain lead, mineral oils, batteries, and other environmentally hazardous materials. When the BladderScan® BVI 9600 has reached the end of its useful service life, return the device, battery charger/wireless hub, and related accessories to a Verathon® Service Center for proper disposal. Alternatively, follow your local protocols for hazardous waste disposal.

Troubleshooting

Help Resources

Verathon® provides an extensive array of customer service resources, described in the table below.







You can obtain copies of this manual, Quick Reference Cards, and clinical studies by visiting the Verathon® Web site at <http://www.verathon.com> or by contacting your Verathon Medical® representative. A complete listing of contact information is provided on page 68.





Resource	Description
BladderScan® BVI 9600 In-Service CD	CD included with the BVI 9600 that provides information on how to use the instrument. Includes user manual, quick reference cards and training videos.
Training modules	Training modules explaining how to take bladder volume measurements (Bladder Volume Mode) and aortic diameter measurements (AortaScan™ Mode) can be found on the In-Service CD. The bladder volume measurement tutorial is also installed on the instrument and can be accessed by pressing the  button from the Home Screen in either Bladder Volume or AortaScan™ Modes.
BladderScan® BVI 9600 Quick Reference Cards	Summary of procedures for using the BladderScan® system.
Clinical Studies	Scientific papers on BladderScan® use.
ScanPoint® Online	ScanPoint® Online provides customers: <ul style="list-style-type: none"> ◆ The ability to calibrate and certify devices online anytime you wish. ◆ Automatic data backup and archiving (HIPAA compliant). ◆ Automatic software upgrades. ◆ Access to real-time troubleshooting from Verathon®.

Resource	Description
Premium Warranty	<p>A Verathon® device warranty plan that provides all the benefits of ScanPoint® Online (preceding paragraph) and also:</p> <ul style="list-style-type: none"> ◆ All repairs performed free of charge. ◆ Instrument insurance: A perpetual warranty against outdated technology with free upgrade / replacement when your device is no longer manufactured. ◆ Free loaner program. ◆ Free shipping.
Verathon® Web site	<p>http://www.verathon.com includes many in-service training resources. From the Verathon® Home page, select “BladderScan®.” On the BladderScan® page, select “Customer Service.”</p>
Phone support	<p>In North America, call: 1.800.331.2313. International customers, please refer to the list of Customer Care Department phone numbers on page 68.</p>

Icons on the BladderScan® Console

The following icons may appear on the instrument’s LCD screen.

Symbol	Meaning
	<p>(Solid arrow) The bladder is contained within the image cone (cone-shaped area in which the Probe transmits ultrasound waves), but not centered. You may be able to obtain a more accurate measurement by re-aiming the Probe in the direction indicated by the arrow.</p>
Battery power level:	
	◆ Indicates a fully charged battery.
	◆ Indicates a battery 50% to 75% charged.
	◆ Indicates a battery 25% to 50% charged.
	◆ Indicates a battery that is nearly discharged and can power only a few more scans.
	◆ Indicates the battery must be changed.

Symbol	Meaning
	Indicates AortaScan™ Mode is active for measuring abdominal aortic diameter.
	The patient is a female patient who has not had a hysterectomy.
	The patient is male, or a female who has had a hysterectomy.
	The bladder is too large to be contained within the scan cone, or the bladder contains more than 999 ml of urine. In AortaScan™ Mode, the arrow indicates an aortic diameter of less than 3 cm

Diagnosing problems

Instrument Does Not Turn On

If the instrument does not turn on, this is usually due to a dead or discharged battery and can be remedied by replacing the dead battery with a charged battery. Check the battery icon in the upper right corner of the LCD display. If the battery icon does not display any power segments, replace the battery.

When the battery charge is too low to allow normal operation (but not too low to permit operation of the internal circuitry) the device displays the following message:

BATTERY CHARGE LEVEL IS TOO LOW FOR
INSTRUMENT OPERATION. RECHARGE BEFORE NEXT USE.

In this case, the battery must be recharged or replaced with a charged one.

Printer Problems

No Paper

The BladderScan® BVI 9600 senses the presence of paper and automatically displays this image when the printer is out of paper (Figure 32).

Figure 32. Printer Out of Paper Screen

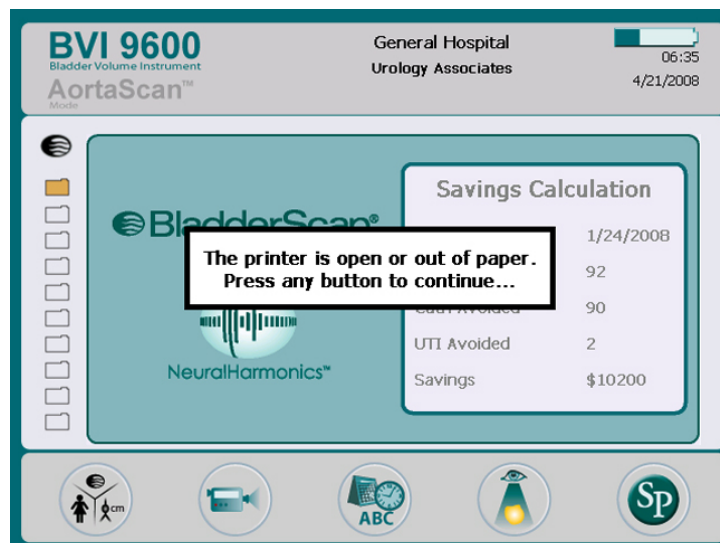

For instructions on loading paper, please refer to the section in this manual titled *Load a Roll of Thermal Paper* beginning on page 22.

Too Hot

The BVI 9600 displays the message “Too hot” if the print head overheats. In this case, turn off the BVI 9600 immediately. This condition may be the result of a paper jam. To clear the paper jam see the following paragraph.

Clearing a Paper Jam

If the paper will not advance through the printer, open the printer door on the back of the Console and clear the paper jam.

CAUTION! Possible device damage.

If the paper jam is inaccessible, do not try to disassemble the printer. Contact your authorized Verathon® Service Center or your local Verathon® distributor for service.

Warranty

Verathon® Inc. warrants the BladderScan® BVI 9600 against defects in material and workmanship as long as it is covered by the Premium Warranty.

Damage or loss insurance is available as part of the Total ReliabilitySM Plan. Pursuant to this warranty, a service center authorized by Verathon® will repair or replace units that prove to be defective during the warranty period.

This warranty does not apply if the unit was misused or modified by anyone other than a service center authorized by Verathon®.

The unit must be used in accordance with the instructions contained in this manual. Consumable items are not covered in this warranty and should be used in conformance with Verathon® product specifications.

For further details, consult your Premium Warranty. Warranty conditions may differ in some countries outside the United States. Contact your local distributor for warranty terms.

Disclaimer of Additional Warranties

There are no understandings, agreements, representations of warranties expressed or implied (including warranties of merchantability or fitness for a particular purpose) other than those set forth in the preceding Warranty section. The contents of this manual do not constitute a warranty.

Some states disallow certain limitations on applied warranties. The purchaser, user, and patient should consult state law if there is a question regarding this disclaimer. This information, descriptions, recommendations, and safety notations in this manual are based upon Verathon® experience and judgment with BladderScan® as of May 2008. The contents of this manual should not be considered to be all-inclusive, or to cover all contingencies.

The physician who directs the use of the BladderScan® BVI 9600 at the institution where it is in use is responsible for keeping current with clinical research in bladder volume measurements.

Please direct any questions or problems concerning bladder volume measurement, using the instrument, or the interpretation of data to the responsible physician.

Contacting Verathon®

The team at Verathon® is committed to modernizing healthcare delivery by putting patients first. Our products support healthcare professionals by providing accuracy, utility, and excellence. For additional product and company information, visit the Verathon® Web site at <http://www.verathon.com>. If you have any questions or comments about Verathon® products and services, please contact us at:

Corporate Headquarters (USA)

Verathon Incorporated
20001 North Creek Parkway
Bothell, WA 98011
USA

Toll free: 800.331.2313 (US & Canada Only)
Tel: 425.867.1348
Fax: 425.883.2896
Web: <http://www.verathon.com>
Email: customerservice@verathon.com

Verathon Medical B. V. (Europe)

EC Rep

Boerhaaveweg 1
3401 MN IJsselstein
The Netherlands

Tel: +31.30.68.70.570
Fax: +31.30.68.70.512
Web: <http://www.verathon.eu/>
Email: customerserviceeu@verathon.nl

Verathon Medical Sarl (France)

Office Address:

Espace Europeen de l'Entreprise
2 allée d'Oslo
67300 Schiltigheim
France

Postal Address:

BP 10039
F-67012 Strasbourg Cedex
France
Tel: +33(0)3.88.60.14.02
Fax: +33(0)3.88.60.46.87
Email: info@verathon.fr

Verathon Medical Ltd. (United Kingdom)

The Granary Manor Farm Courtyard
Aston Sandford, Aylesbury
Buckinghamshire, HP17 8JB
United Kingdom

Tel: +44.1844.299.207
Fax: +44.1844.299.218
Web: <http://www.verathon.co.uk/>
Email: customerserviceuk@verathon.co.uk

Verathon Medical K. K. (Japan)

Executive Tower Azabudai 7F
1-4-3 Azabudai
Minato-ku
Tokyo, Japan 106-0041

Tel: +81.03.3560.3501
Fax: +81.03.3560.3502
Email: servicejp@verathon.com

Safety and Performance Summary

- ◆ The BladderScan® BVI 9600 computes the volume of the urinary bladder or diameter of the abdominal aorta based upon twelve cross-sectional ultrasound images. For maximum accuracy, be sure to hold the Probe motionless while scanning.
- ◆ The most accurate measurements are obtained when the patient rests quietly in a supine position.
- ◆ Errors in usage tend to result in the underestimation of bladder volume, except in cases where the Probe is moved during scanning. In this case, the measurement may overestimate the patient's bladder volume.
- ◆ We recommend that new users use the BladderScan® BVI 9600 to measure patients with moderately full bladders rather than initially attempting to locate a bladder with a low urinary volume.
- ◆ To conserve battery power, the BladderScan® BVI 9600 shuts itself down automatically when not in use (goes into "sleep").

WARNING! Risk of explosion.

There is a possible risk of explosion if the BladderScan® BVI 9600 is used in the presence of flammable anesthetics.

WARNING! Risk of patient injury.

Do not use the BladderScan® BVI 9600 on patients with open skin or wounds in the suprapubic region.

CAUTION: Risk of inaccurate measurements.

- ◆ Accuracy is compromised if the user does not obtain an optimal, repeatable image.
- ◆ The BladderScan® BVI 9600 is not intended for use on pregnant patients.
- ◆ The patient being scanned should not have a catheter in his/her bladder. This could create microbubbles in the bladder, which will compromise the accuracy of the measurement.
- ◆ Use care when scanning suprapubic and pelvic surgery patients. Scar tissue, surgical incisions, sutures, and staples can affect ultrasound transmission and reflection.
- ◆ Patients should fast for 12 hours prior to undergoing an aortic diameter measurement to minimize the presence of bowel gas, which may obstruct accurate measurement of abdominal aortic diameter.

Parts and Accessories

BladderScan® BVI 9600 System Components

The following components are included with your BladderScan® BVI 9600 system.





Part Number	Description
0570-0351	BVI 9400/9600 Probe
0570-0212	BVI 9600 Console
0570-0193	Battery Charger/Wireless Hub
0400-0067	Desktop Power Supply
0400-0066	Rechargeable batteries (2 included)
0800-0319	Roll of Thermal Paper: Properly-sized paper for the on board printer.
0620-0340	Calibration Kit (Optional - requires ScanPoint® with QuickPrint software)
0800-0322	Medical Cart (optional)
0900-2147	BladderScan® BVI 9600 User's Manual (on In-Service CD)
0900-1644	BladderScan® BVI 9600 In-Service CD (with User's Manuals, Video Tutorials, and Quick Reference Cards)
0900-1601	ScanPoint® with QuickPrint User's Manual (on In-Service CD)
0900-1647	Quick Reference Card - BladderScan® BVI 9600 Bladder Volume Measurement
0900-1648	Quick Reference Card - BladderScan® BVI 9600 AortaScan™ Aortic Diameter Measurement
0900-1447	Quick Reference Card - Calibration
0900-4344-00-60	BVI9600 User's Manual addendum

To order any of the above parts, contact your authorized Verathon Medical® sales representative or contact the Verathon Medical® Customer Care Department at 1.800.331.2313.

Product Specifications

Symbol Directory

The following table explains the industry symbols used to indicate the BladderScan® system compliance with international and national standards and regulations.

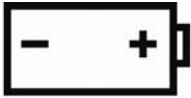
Symbol	Meaning
	Marked in accordance with Directive 2002/96/EC on Waste Electrical and Electronic Equipment (WEEE) (solid bar indicates product was put on the market after 13 August 2005.)
	Class II equipment protected throughout by double or reinforced insulation.
	Type BF applied part with EN/IEC-60601-1.
	CE marked in accordance with the Medical Device Directive (MDD).
	Canadian Standards Association (CSA) mark of certification to United States standards for electromedical equipment.
 #0400-0066	This unit is powered by a Lithium-Ion battery pack. The Verathon® part number for the battery pack is 0400-0066.

Standards and Regulations Compliance

Verathon® certifies that all units are in compliance with all applicable international and national standards and regulations, including but not limited to the following:

Specification	Standard
International Electrotechnical Commission	EN/IEC 60601-1 Amendments 1 and 2 and EN/IEC 60601-1-2 (EMC)
Safety Standard	EN/IEC 60601-2
Medical Device Directive	MDD 93/42/EEC Annex 1
Canadian Standards Association	C22.2 No. 601.1-M90 (Master Contract No. 177198)
Underwriters Laboratories, Inc.	UL 60601-1
Health Insurance Portability and Accountability Act (HIPAA)*	

*For details on Verathon® compliance with privacy rules, please refer to the information in the QuickPrint Help menu (select PRIVACY AGREEMENT).

Electromagnetic Effects

There are no restrictions on the use of BladderScan® BVI 9600 due to its electromagnetic characteristics. Both the emissions from BladderScan® and the susceptibility of this instrument to interference from other sources are within prescribed limits of all applicable standards at the date of manufacture. The emissions test procedure that was used is specified in EN/ IEC55011: 1991 for Group 1, Class A equipment (per EN/IEC60601-1-2, 36.201.1.7).

BladderScan® BVI 9600 is suitable for use in industrial, scientific, and medical (ISM) environments, and in domestic environments under the jurisdiction of a health care professional. An indication of adverse electromagnetic effects from BladderScan® BVI 9600 on another electronic device would be a degradation of performance in the other device when the devices are operated simultaneously. If such interference is suspected, separate the two devices as much as possible, or discontinue simultaneous operation, if practical, and contact Verathon®.

BladderScan® BVI 9600 will operate normally in the proximity of other potential interference sources, and has demonstrated immunity at a field strength of 3 V/m (per EN/IEC 60601-1-2, 36.202.2.1). You do not need to take any other precautions regarding exposure in reasonably foreseeable environmental conditions to magnetic fields, pressure, or variations in pressure, acceleration, or thermal ignition sources.

BladderScan® BVI 9600 Instrument Specifications

For technical performance assessment in an acoustic laboratory, the Probe cannot be immersed in water.

Item	Specification
Input	Lithium Ion Battery Pack. Verathon P/N 0400-0066.
Output	No load to full load at rated voltage. Refer to unit label.
Insulation	The power supply is Class I with basic insulation to each terminal.
Transient Overvoltage:	Category II
Weight	5.2 lb (2.36 kg) (with battery)
Display	13.36cm W x 10.13cm H (5.26" W x 3.99" H) (640 x 480 pixels, 120 dpi)
Integrated Printer	Thermal label printer
Languages	English (default), Chinese Simplified, Chinese Traditional, Czech, Danish, Dutch, Finnish, French, German, Greek, Hungarian, Italian, Japanese, Korean, Norwegian, Portuguese, Spanish, Swedish, Turkish

Ultrasound Output Parameters - Acoustic Output Limits

Item	Specification
Maximum ultrasound I_{sptad} (Intensity Spatial Peak Temporal Average derated)	$\leq 5.0 \text{ mW/cm}^2$
I_{sppad} (Intensity Spatial Peak Pulse Average derated) Range	$\leq 60.0 \text{ W/cm}^2$
Maximum MI (Mechanical Index)	0.95 max
TIS/TIB/TIC Range	0.0 - 4.0
Transducer diameter	13 mm (0.512 inches)
Transducer resonant frequency	3.0 MHz and 1.74 MHz
Transducer bandwidth	75% at 10 dB
Time from 3D scan initiation to result display	< 3 seconds

Item	Specification
Penetration depth (in normal North American patient)	≥ 15 cm

Accuracy Specifications

The accuracy specifications assume the instrument is being used according to the instructions provided by Verathon®, scanning a tissue-equivalent phantom.

Specification	Description
Bladder volume accuracy	± 15%, ± 15 ml (on a Verathon® tissue-equivalent phantom)
Bladder volume range	0 - 999 ml
Aorta diameter range	3 - 12.4 cm
Diameter accuracy	+/- 15%, +/- 0.5 cm (on a Verathon® tissue-equivalent phantom)

BladderScan® BVI 9600 Operating Conditions

The BladderScan® BVI 9600 is designed to function properly within the following specifications:

Condition	Description
Use	Indoor
Ambient temperature range	+10 - +40° Celsius (+50 - +104° Fahrenheit)
Atmospheric pressure range	700 hPa - 1060 hPa
Relative humidity	30% - 75% non-condensing
Water resistance	Rated at IPX1 (indicates DRIP-PROOF, a higher than ORDINARY level of protection from drips, leaks, and spills)

BladderScan® BVI 9600 Storage Conditions

The BladderScan® BVI 9600 is designed for storage under the following conditions:

Condition	Description
Storage	Indoor
Ambient temperature range	-20 - +60° Celsius (-4 - +140° Fahrenheit)
Atmospheric pressure range	500 hPa - 1060 hPa
Relative humidity	20% - 95% non-condensing

BladderScan® BVI 9600 Displays, Controls, and Indicators

The BladderScan® BVI 9600 provides the following controls, connectors, and features:

Instrument Buttons

POWER ON/OFF, BRIGHTNESS (▲/▼), and VOLUME (▲/▼) are located on the lower half of the Console. SCAN (on the Probe). The five buttons below the Console LCD have variable functions depending on current instrument mode as follows:

Screen/Mode	Active Buttons
<p>Start up screen</p> <p>Appears only when the instrument is activated for the very first time.</p>	<p>POWER, VOLUME, BRIGHTNESS</p> <p>(1) - (5) No function.</p>
<p>Home Screen</p> <p>Appears when the instrument is turned on.</p>	<p>POWER, SCAN: opens Aim/Scan screen, (1) PATIENT TYPE: toggle between two bladder volume modes: female with uterus, all other patients; and AortaScan™ aortic diameter measurement mode (2) TUTORIAL: opens Tutorial screen, (3) SETTINGS: opens Settings screen (4) REVIEW: opens the Review screen, (5) SCANPOINT®: transmits saved exams to ScanPoint®.</p>
<p>Scan Screen:</p> <p>Appears when the operator presses and releases the SCAN button.</p>	<p>POWER: No function</p> <p>SCAN: Press to take a scan.</p> <p>Buttons (1) - (5): No action.</p>

Screen/Mode	Active Buttons
<p>Results Screen</p> <p>Appears when the operator releases the SCAN button (after aiming).</p>	<p>POWER, SCAN: opens Aim/Scan screen:</p> <p><u>Bladder Volume Mode</u> -- (1) RECORD: press to record voice annotation, press STOP to end voice annotation, (2) PRINT: print to onboard printer, (3) LISTEN: press to play voice annotation; otherwise, no function, (4) REVIEW: opens review screen if a voice annotation has been recorded; otherwise, no function. (5) HOME: return to Home screen.</p> <p><u>AortaScan™ Mode</u> -- (1) RECORD: press to record voice annotation, press STOP to end voice annotation, (2) PRINT: prints scan results using onboard printer (3) LISTEN: press to play voice annotation; otherwise, no function, (4) MANUAL MODE: allows manual measurement of aortic diameter. (5) HOME: return to Home screen.</p>
<p>Review Screen</p> <p>Review, replay, print, or delete saved exams</p>	<p>POWER, SCAN, (1) NEXT: select next exam in memory, (2) PRINT: print to on-board printer, (3) LISTEN: replay voice annotation for currently selected exam, (4) DELETE: delete currently selected exam, (5) HOME: return to Home screen.</p>
<p>Tutorial Screen</p> <p>View the menu of training modules.</p>	<p>POWER, (1) Skip to next tutorial, (2) Skip to previous tutorial, (3) Select tutorial for viewing (4) No function, (5) Home (return to Home screen).</p>
<p>Video Viewing Screen</p> <p>The video viewing screen.</p>	<p>POWER, (1) No function, (2) Play/Pause, (3) Return to Tutorial (4) No function, (5) Home (return to Home screen).</p>
<p>Settings Screen</p> <p>Edit clinic name, date & time, general preferences, savings preferences, and self-test options.</p>	<p>POWER, (1) Select next setting in list, (2) Select previous setting in list, (3) Enter (proceed to the selected screen), (4) No action, (5) Home (return to Home screen).</p>
<p>Alpha-Numeric Screen</p> <p>Displays alpha-numeric characters for entering information.</p>	<p>POWER, (1) Move down, (2) Move right, (3) Add currently selected character, (4) Delete currently selected character, (5) Return to main setup screen.</p>
<p>Date & Time Screen</p> <p>Allows the user to set the date and time</p>	<p>POWER, (1) Move forward to next changeable unit, (2) Move back to previous changeable unit, (3) Add/toggle units as appropriate (hold down to move faster), (4) Decrease/toggle units as appropriate (hold down to move faster), (5) Save current date/time entries and return to main Setup screen.</p>

Screen/Mode	Active Buttons
General Preferences Screen Set preferences for language, time and date format, time format, Calibration Warning and Print Report Type	POWER, (1) Select next setting in list, (2) Select previous setting in list, (3) Select next option, (4) Select previous option, (5) Save current entries and return to main Setup screen. <u>Preferences list and options:</u> <u>Languages:</u> English (default), Chinese Simplified, Chinese Traditional, Czech, Danish, Dutch, Finnish, French, German, Greek, Hungarian, Italian, Japanese, Korean, Norwegian, Portuguese, Spanish, Swedish, Turkish. <u>Date format:</u> mm/dd/yyyy, dd.mm.yyyy, yyyy-mm-dd <u>Time Format:</u> 12-hour, 24-hour <u>Calibration Warning:</u> On (default), Off. When “On” is selected, a calibration warning will appear in the display header when the device requires calibration. <u>Print Report Type:</u> B-Mode (default), C-Mode
Savings Preferences Screen Set preferences for UTI Cost Savings Tracking	<u>UTI Rate:</u> 1% - 100% in increments of 1% <u>UTI Cost:</u> \$10 - \$100,000 in increments of \$1 <u>Catheter Cost:</u> \$1 to \$1000 in increments of \$1 <u>Catheter Volume:</u> 20 ml - 100 ml in increments of 20 ml <u>Currency:</u> \$ / € / £ / ¥ <u>Savings Calculation:</u> Since new, Since 1/1/2006, Reset Now, Print Since New, Print Recent, Hide Savings.
Self-Test Screen	(1) to (5): No function
ScanPoint® Screen	(NOTE: Only available when used with ScanPoint® with QuickPrint software.) POWER, (1) No function, (2) No function, (3) No function, (4) CANCEL, (5) No function.

Instrument Display

The instrument display is divided into three horizontal panes:

- ♦ The header pane displays the instrument mode (Bladder Volume or AortaScan™), the institution name, date, time and a battery status icon.
- ♦ The center pane is the main display area. The information displayed in the center pane varies depending on the device mode.
- ♦ The footer pane displays icons that indicate button functions, as described in the preceding table.

Screen/Mode	Display
Home Screen	Mode indicator, Memory indicator, NeuralHarmonics™ or AortaScan™ indicator, Savings Calculation table (Bladder Volume mode only).
Scan Screen	Appears when the operator presses the SCAN button. <u>Bladder Volume Mode</u> -- As bladder volume is calculated, the display refreshes and updates until the scan is complete. <u>AortaScan™ Mode</u> -- Bowel gas is indicated by white lines in the Aiming (C-Mode) display, with the aorta appearing as a red area at the end of the scan.
Results Screen	<u>Bladder Volume Mode</u> -- Appears when a bladder volume scan is complete. Displays calculated bladder volume, patient type, available memory and Aiming display. <u>AortaScan™ Mode</u> -- Appears when an aortic diameter scan is complete. Displays the final Aiming display and the Results (B-Mode) display. The Results display shows the abdominal cross section as a speckled gray ultrasound cone with the aorta shown as a black circle if greater than 3 cm in diameter.
Review Screen	<u>Bladder Volume Mode</u> - Displays either the Aiming display or the Results display along with calculated bladder volume in ml. <u>AortaScan™ Mode</u> - Displays either the Aiming display or the Results display along with calculated aortic diameter in cm.
Tutorial Screen	Lists available video tutorials.
Settings Screen	Lists options for setting name, date and time, general and savings preferences, and self text.
Name Screen	A grid of alpha-numeric characters.
Date & Time Screen	Options for setting date, time and display formats.
Preferences Screen	List of available settings and their current values.
Self-Test Screen	Displays test progress and results.
ScanPoint® Screen	When ScanPoint® with QuickPrint is installed: Displays status information about the ScanPoint® communication. For example, when uploading an exam, the screen displays a progress bar.

Battery Charger/Wireless Hub Specifications

The battery charger/wireless hub is powered from a standard wall outlet (adaptable to international power standards). The battery charger/wireless hub can charge two batteries simultaneously.

Operating Conditions

The following are proper operating conditions for the battery charger/wireless hub:

Specification	Description
Use	Indoor
Ambient temperature range	+5 - +40° Celsius (+41 - +104° Fahrenheit)
Atmospheric pressure range	70 kPa - 106 kPa
Relative humidity	30% - 75% non-condensing
Water resistance	Rated at IPX 0 (ordinary equipment without protection against ingress of water)
Computer connection	USB 2.0
Charger	Powered by a desktop DC power supply.
Input voltage	100 - 240 VAC RMS
Input frequency	50 - 60 Hz
Input current	1 Amp max
Input connection	2 wire IEC 60320 C7
Output	9v at 1 Amp
Insulation	Class II with double insulation
Fuses	250 VAC, 2A, quick acting
Testing	CSA 60950-1-03/UL 60950-1

Storage Conditions

Condition	Description
Use	Indoor
Ambient Temperature Range	+5 - +40° Celsius (+41 - +104° Fahrenheit)
Atmospheric pressure range	70 kPa - 106 kPa
Relative humidity	30% - 75% non-condensing
Water resistance	Rated at IPX 0 (ordinary equipment without protection against ingress of water)

Battery Specifications

The BladderScan® BVI 9600 is provided with two Lithium Ion batteries. A battery icon on the instrument display is always present indicating how much power remains and when the battery needs to be changed. The user can change the battery whenever necessary. Removing a discharged battery and replacing with a fresh battery will not erase any saved exams or user settings. Use only the battery charger provided with the BVI 9600. Any other battery charger may damage the battery pack.

The batteries meet the following specifications:

Condition	Description
Battery type	Lithium Ion
Battery life	A fully charged battery can provide approximately 30 exams within a 24-hour period.
Charging time	Charging time offline will take no more than six hours from an empty battery to a full charge.
Rated capacity	4800 mAh
Normal voltage	11.1 V
Max charging voltage	12.6 V
Max weight	350 g
Width	3.11 in (79 mm)
Length	4.65 in (118 mm)
Thickness	0.91 in (23 mm)

Glossary

Term	Meaning
Aiming display	Ultrasound image showing the bladder on a white field with green crosshairs in Bladder Volume Mode, or the aorta and bowel gas on a blue field with green crosshairs in AortaScan™ Mode. In each respective mode, the Aiming Display shows the location of the bladder or aorta and bowel gas within the ultrasound cone radiating from the Probe. Also referred to as C-Mode
AortaScan™	AortaScan™ Mode transmits ultrasound energy to produce an image of the patient's abdominal aorta and determine abdominal aortic diameter.
B-Mode	Ultrasound images showing an abdominal cross-section with the bladder or aorta shown as a dark circle. Also referred to as the Results display.
Battery Charger/Wireless Hub	The unit that charges the Lithium Ion batteries that power the BladderScan® and simultaneously receives and sends information from/to a BVI 9600 instrument within communication range.
BladderScan®	The BladderScan® instrument transmits ultrasound energy to produce an image of the patient's bladder and determine bladder volume.
C-Mode	Ultrasound image showing the bladder (in Bladder Volume Mode) or aorta and bowel gas (in AortaScan™ Mode) found within the ultrasound cone. Also referred to as the Aiming display.
Calibration	Checking the accuracy and function of your BladderScan® by comparing it with a known standard.
Calibration Kit	Tools for calibrating your BladderScan®. The calibration container has a spiral-shaped target which provides a known reference in a spherical coordinate system. The calibration of the instrument to this known reference increases the accuracy of volume measurements.
Console	The main BladderScan® device that provides operating controls and communicates with the user via images and text displays on an LCD screen.
Coupling medium	A substance, such as ultrasound gel or a gel pad, that enhances the transmission of ultrasound waves.

Term	Meaning
Flashing Aiming Arrows 	Indicate the bladder is not inside the scan cone and the Probe needs to be redirected. The arrow shows the direction to move or tilt the BladderScan® to improve the measurement. Re-aiming is required.
Gel pad	Sontac® Gel Pad: A disc-shaped, gel-filled pad that enhances the transmission of ultrasound waves.
HIPAA	<p>Health Insurance Portability and Accountability Act, enacted by the US Congress in 1996.</p> <p>Title II of HIPAA, the Administrative Simplification provisions (AS), requires the establishment of national standards for electronic health care transactions and national identifiers for providers, health insurance plans, and employers. The AS provisions also address the security and privacy of health data. The standards are meant to improve the efficiency and effectiveness of the nation's health care system by encouraging the widespread use of electronic data interchange in the US health care system.</p>
Image cone	During a measurement, this is the cone-shaped area in which the Probe transmits ultrasound waves.
Instrument	In this manual, refers to the BladderScan® BVI 9600. The BladderScan® instrument transmits ultrasound energy to produce an image of the patient's bladder and determine bladder volume.
LCD screen	The LCD (liquid crystal display) screen on the BladderScan® Console that displays measurement information, instrument status, and other exam settings and information.
Mid-abdominal region	The mid-abdominal region is the central section of the abdomen running from the xiphoid process at the bottom of the sternum to the navel.
NeuralHarmonics™ Technology	A patented BladderScan® technology that sharpens accuracy and accelerates speed of three-dimensional ultrasound bladder volume measurements.
Probe	The handheld part of the BladderScan® instrument that transmits ultrasound energy to the patient.
Results display	Ultrasound image showing an abdominal cross-section with the bladder or aorta shown as a dark circle on a field of speckled gray. Also referred to as B-Mode.
SCAN button	Located on the underside of the BladderScan® Probe, this button is used to initiate the measurement.

Term	Meaning
ScanPoint® bladder imaging technology	The software and online service provided by Verathon® that prints exam results, maintains patient records, displays ultrasound images from exams, downloads software updates, and calibrates the BladderScan® instrument.
ScanPoint® with QuickPrint	ScanPoint® with QuickPrint is a software program installed on your computer that communicates with ScanPoint® Online to help you quickly and easily download and print exam reports.
Sleep Mode	When the BladderScan® instrument shuts down to conserve energy. Press any button to turn on the instrument.
Solid aiming arrow	Indicates the bladder is inside the scan cone but is not completely centered. The arrow shows the direction to move or tilt the BladderScan® to improve the measurement. Re-aiming is optional but not required.
Supine position	Refers to the patient laying on their back.
Suprapubic	The area above the pubic bone.
Symphysis pubis	The front of the pelvis where the pubic bones meet.
Ultrasonic	Involving ultrasound. Ultrasound is sound at frequencies above the range that can be heard by the human ear.
Xiphoid Process	The xiphoid process is the small cartilaginous extension to the lower part of the sternum.