

OPERATOR MANUAL

Amsco® 3085 SP™ Surgical Table

(10/01/04)

P150830-026

A WORD FROM STERIS CORPORATION

This manual contains important information on proper use and maintenance of the Amsco® 3085 SP™ Surgical Table. **All personnel involved in the use and maintenance of this equipment must carefully review and comply with the warnings, cautions, and instructions contained in this manual.** These instructions are important to protect the health and safety of personnel operating a 3085 SP table and should be retained in a conveniently accessible area for quick reference.

Complete instructions for uncrating have been furnished. If missing, contact STERIS for a replacement copy, giving the serial and model numbers of the unit.

STERIS carries a complete line of accessories for use with this table. A STERIS representative will gladly review these with you.

Advisory

A listing of the *Safety Precautions* to be observed when operating and servicing this equipment can be found in **SECTION 1** of this manual. Do not operate or service the equipment until you have become familiar with this information.

Any alteration of this equipment not authorized or performed by STERIS Engineering Service will void the warranty, could violate federal, state, and local regulations, and jeopardize your insurance coverage.

Indications for Use

The Amsco 3085 SP Surgical Table is a mobile, electrohydraulically operated general surgical table providing flexible articulation of the surgical patient.

Service Information

A thorough preventive maintenance program is essential to safe and proper unit operation. This manual contains maintenance schedules and procedures which should be followed for satisfactory equipment performance.

Customers are encouraged to contact STERIS concerning our comprehensive preventive maintenance agreement. Under the terms of this agreement, preventive maintenance, adjustments, and replacement of worn parts are done on a scheduled basis to help assure equipment performance at peak capability and to help avoid untimely or costly interruptions. STERIS maintains a global staff of well equipped, factory-trained technicians to provide this service, as well as expert repair services. Please contact STERIS for details.

NOTE: *A patient grounding post/potential equalization terminal (male connector, DIN 42801) is provided. The mating female connector is not furnished by STERIS.*



EC Authorized Representative

STERIS Limited
STERIS House
Jays Close
Viables
Basingstoke
Hampshire
RG22 4AX
UNITED KINGDOM

Manufactured by:
STERIS Corporation
2720 Gunter Park East
Montgomery, AL 36109 • USA



Class 1 Equipment
Type B Equipment

Ordinary Equipment
(enclosed equipment without
protection of ingress of water).

Equipment not suitable for use
in the presence of a flammable
anesthetic mixture with air or
oxygen or nitrous oxide.

Suitable for continuous use.

**STERIS Corporation,
Montgomery, Alabama is an
ISO 13485 certified facility.**

**The base language of this document is
ENGLISH. Any translations must be
made from the base language document.**

TABLE OF CONTENTS

Section	Title	Page
	A WORD FROM STERIS CORPORATION	i
1	SAFETY PRECAUTIONS	1-1
2	IMPORTANT USER INFORMATION	2-1
2.1	Pinch Point Warnings	2-1
2.2	Patient Positioning and Weight Limitation	2-1
2.2.1	Prevent Possible Tipping	2-3
2.2.2	For Reverse Patient Orientation	2-3
2.2.3	Other Considerations	2-4
2.3	General Description	2-4
2.4	Technical Specifications	2-5
2.4.1	Overall Size (W x L x H)	2-5
2.4.2	Weight	2-5
2.4.3	Utility Requirements	2-5
3	INSTALLATION INSTRUCTIONS	3-1
3.1	Install and Route Power Cord	3-2
3.2	Install Hand Control and Lock Table in Place	3-3
3.2.1	Standard 3085 SP Tables Hand Control	3-3
3.2.2	Operating Room Control System (ORCS) Hand Control	3-3
3.2.3	Lock Table in PLace	3-4
3.3	Hand Control Interchangeability	3-5
4	OPERATING INSTRUCTIONS.....	4-1
4.1	Attach Headrest and Orient Patient	4-1
4.2	Tabletop Positioning	4-3
4.2.1	Hand Control Operation	4-3
4.2.2	Optional Foot Control Operation	4-5
4.2.3	Care of Controls When Not In Use	4-7
4.3	Optional Operating Room Control System (ORCS) Operation	4-8
4.3.1	HERMES-Ready System Operation	4-8
4.3.2	ACT Enabled System Operation	4-9
4.4	Headrest Positioning	4-10
4.5	Kidney Bridge Elevation	4-10
4.6	Pads and Accessories	4-11
4.6.1	Tabletop Pads	4-11
4.6.2	X-Ray Top Accessories	4-11
4.6.3	General Accessories Applied to Side Rails	4-12
4.6.4	Accessories Specific to Amsco 3085 SP Tables	4-13

TABLE OF CONTENTS (Cont'd)

Section	Title	Page
5	AUXILIARY OVERRIDE SYSTEMS	5-1
5.1	Articulation With Electric Pump Power Available	5-2
5.2	Articulation With No Electric Pump Power Available	5-3
5.3	Floor Lock Override Systems	5-3
6	ROUTINE MAINTENANCE	6-1
6.1	Preventive Maintenance Schedule	6-1
6.2	Cleaning/Disinfecting Procedures	6-3
6.2.1	Post-Usage	6-3
6.2.2	End-of-Day	6-4
6.2.3	Weekly	6-4
6.3	Biweekly Maintenance	6-5
6.4	Monthly Maintenance	6-5
6.5	Battery Charging Procedure	6-6
6.5.1	Electric-Powered Tables	6-6
6.5.2	Battery-Powered Tables	6-6
7	TROUBLESHOOTING	7-1
8	SERVICE PROCEDURES	8-1
8.1	Reset Circuit Breakers	8-1
8.2	Change Fuses	8-2
8.3	Disconnect the Motor Battery	8-2
8.4	Replacement Parts	8-3
9	DISPOSAL HAZARDS	9-1

SAFETY PRECAUTIONS













1

The following *Safety Precautions* **must** be observed when operating and servicing this equipment. WARNING indicates the potential for personal injury, and CAUTION indicates the potential for damage to equipment. These *Safety Precautions* are repeated, where applicable, throughout the manual.

WARNING – PINCHING HAZARD:

-  Pinch points are created during extreme tabletop articulation. Carefully review illustrations in Figure 2-1 before operating the table.
-

WARNING – TIPPING HAZARD:

-  Do not place patient on the table unless floor locks are engaged.
 -  Do not release floor locks while patient is on table.
 -  Do not use this table for patients exceeding the 1,000-lb (452-kg) limit when patient is positioned in normal orientation. The maximum safe patient weight on this table for standard surgical positions in normal orientation is 1,000 lb (452 kg) with floor locks locked.
 -  Do not use this table for patients exceeding the 500-lb (226-kg) limit when patient is positioned in reversed orientation. The maximum safe patient weight on this table for standard surgical positions in reversed orientation is 500 lb (226 kg) with floor locks locked.
 -  When performing surgery requiring a headrest accessory in reversed patient orientation, or when using a Fem/Pop board or the 3080/3085 Ortho Extension accessory, do not exceed the 400 lb (181 kg) patient weight.
 -  Do not use the Fem/Pop Board with X-ray Tops for bariatric patients.
 -  Foot Extension Accessory or combination of Foot Extension and Headrest Accessories from previous design STERIS tables must not be used for reverse orientation on the 3085 SP Table.
 -  Do not use two or more Uro-Endo/Image Amplification Extension accessories together on the 3085 SP Table.
 -  Do not articulate table with auxiliary override systems unless floor locks are engaged.
 -  During an articulation if the tabletop sections contact an obstruction, the table may tip. Before lowering either the table top or individual sections, remove possible obstructions. Do not allow leg section, when lowered, to contact the floor.
 -  Fem/Pop Board must be installed into leg section only. Board must be used to support the legs only. It is not intended to support upper body weight.
 -  Do not use the Fem/Pop Board with patients exceeding 400 lbs (181 kg).
-







WARNING – EXPLOSION HAZARD:

-  Table must not be used in the presence of flammable anesthetics.
-



WARNING – TRIPPING HAZARD:

-  Route the power cord to the receptacle in a position so it will not be tripped over by personnel in the area.

WARNING – PERSONAL INJURY HAZARD:

-  Healthcare professionals must ensure patients are positioned and monitored to prevent compromising respiration, nerve pathways, or circulation.
 -  When installing any table accessory, check for correct attachment and tighten securely (if appropriate). Do not use worn or damaged accessory. Check installation before using any accessory.
 -  There is a 1,000-lb (452-kg) patient weight limit if patient is in normal orientation and a 500-lb (226-kg) patient weight limit if patient is in reversed orientation; however, the accessory load rating may be lower. Do not exceed the accessory load rating if it is lower than the table rating.
 -  Unanticipated table movement could cause patient injury. Patient must be secured to the table in accordance with recommended positioning practices.
 -  Do not immerse any part of foot control in liquids; this could cause unanticipated table movement, leading to patient injury. Always cover control with a plastic bag before using.
 -  If the integrity of the external protective earth conductor installation or arrangement is in doubt, operate the table from its internal power source.
-



WARNING – INSTABILITY HAZARD:

-  Stabilize table when transferring patient.
 -  Possible patient or user injury, as well as table or accessory failure, may result from using STERIS table accessories for other than their stated purpose - or from using, on STERIS tables, accessories manufactured and sold by other companies.
 -  Patient Transfer Board must be used as a leg support only. It is not intended to support upper body weight of a patient.
-

WARNING – PINCHING AND TIPPING HAZARD:

-  Patient injury may result if the operator of this table is not completely familiar with the controls for patient positioning and table operation.
-

WARNING – PERSONAL INJURY AND/OR EQUIPMENT DAMAGE HAZARD:

-  Safe and reliable operation of this equipment requires regularly scheduled preventive maintenance, in addition to the faithful performance of routine maintenance. Contact STERIS to schedule preventive maintenance.
-  Repairs and adjustments to this equipment must be made only by fully qualified service personnel. Nonroutine maintenance performed by inexperienced, unqualified personnel or installation of unauthorized parts could cause personal injury, invalidate the warranty, or result in costly damage. Contact STERIS regarding service options.















WARNING – INFECTION HAZARD:

-  To protect against aerosols being reflected from contaminated surfaces, wear rubber or plastic gloves, masks and eye protection and follow OSHA blood-borne pathogens standards when cleaning.

WARNING – DISPOSAL HAZARD:

-  This product contains materials which may require disposal through appropriately licensed and permitted hazardous waste management firms.











CAUTION – POSSIBLE EQUIPMENT DAMAGE:

-  When moving the table to point of use, roll it carefully at moderate speed and only over smooth floors. Maximum floor clearance is 1/4" (6 mm). Avoid door jambs, elevator jambs, and obstructions greater than 1/4" (6 mm). If necessary, lift uncrated table over obstructions, onto trucks, etc. Lift table evenly and only by the table base. DO NOT transport articles (including accessories) on top of the table and DO NOT use a forklift to move the uncrated table.
-  Route the hand control cord (and optional HERMES®-Ready¹ or ACT Enabled™ interface cord and/or optional foot control cord, if applicable) clear of any pinch points where the cord(s) could be damaged.
-  The use of incorrect hydraulic oil may severely damage the table and/or cause malfunction. Contact STERIS for the proper oil to use.
-  For ORCS equipped tables, use the HERMES®-Ready¹ or ACT Enabled™ 3085 SP hand control with the blue strain relief on the plug. The standard 3085 SP hand control has a red strain relief on the plug. **These two hand controls are not interchangeable.**
-  Hang the hand control from side rail (or end rail) of the table when not in use, to avoid possible damage to the control.
-  During some extreme articulations, the tabletop may contact the base and/or column shrouds. Take care to avoid positioning the table in such a way as to cause damage to the shrouds.
-  Use caution when raising the seat section or back section while the kidney bridge is elevated. The section may contact the elevated kidney bridge and damage the bridge and/or section.
-  When cleaning/disinfecting table, do not use phenolics, which may cause patient skin burns if inadequately rinsed off, or alcohol, which does not have sufficient cleaning/disinfection properties.
-  When cleaning/disinfecting table, thoroughly read the cleaning fluid directions for use and follow all directions and cautions as shown.
-  Do not spray cleaning fluid into electric receptacles and avoid spraying directly on override switches or into clearance space above column. Spray or drippage may settle onto electric circuits inside table causing corrosion and loss of function.
-  Cleaning procedures requiring articulation of the table should be performed only by persons familiar with table operation.
-  After performing cleaning procedures, ensure pads and X-ray tops are completely dry before reinstalling. Moisture trapped between pads and X-ray tops may contribute to equipment damage, such as X-ray top warpage.
-  Table may cause dimpling of cushioned vinyl flooring or other soft flooring. When fully loaded to 500 lb (226 kg) patient load, the floor lock feet exert up to 380 psi (2,619 KPa) pressure on the floor. The pressure may reach 440 psi (3,033 KPa) with a 1,000-lb (452-kg) patient load.
-  The table has internal switches for setting to various AC-input voltages. Improper setting of switches may damage table electrical system and/or cause improper operation of the table.
-  The HERMES®-Ready¹ and ACT Enabled hand controls are interchangeable for control of table functions; however, ORCS voice-activation control will NOT operate properly with improper hand control.

















¹HERMES-Ready is a registered trademark of Computer Motion.

Definition of Symbols



Following is a key to symbols which may be on your table or controls.

Symbol	Definition
	Protective Earth (Ground)
	Attention, Consult Manual for Further Instructions
A	Amperage Rating of the Unit
V	Voltage Rating of the Unit
~	Alternating Current
kW	Power Rating of the Unit
Hz	Frequency of the Unit
	Equipotentiality
	Type B Equipment
	Powered by AC
	Powered by Battery
	Battery Charged
	Battery Down
	Optional HERMES-Ready System Installed
	ON
	OFF

Continued ...

Symbol	Definition
	Floor Lock (Function Touch Pad)
	Floor Lock: Lock
	Floor Lock: Unlock
	Patient Orientation (Function Touch Pad)
	Normal Orientation
	Reverse Orientation
	Trendelenburg
	Reverse Trendelenburg
	Height Up (Raise)
	Height Down (Lower)
	Tilt Left
	Tilt Right
	Back Up
	Back Down
	Leg Up
	Leg Down

Continued ...

Symbol	Definition
	Flex
	Reflex
	Level

2.1 Pinch Point Warnings



WARNING - PINCHING HAZARD: Pinch points are created during extreme tabletop articulation. Carefully review the illustrations in Figure 2-1 before operating the table.

During extreme tabletop articulation, various possible pinch points exist. These points are identified in Figure 2-1. All personnel involved in tabletop positioning should examine and be aware of these points before operating the table.

2.2 Patient Positioning and Weight Limitation



WARNING – TIPPING HAZARD:

- Do not place patient on the table unless floor locks are engaged.
- Do not release floor locks while patient is on table.
- Do not use this table for patients exceeding the 1,000-lb (452-kg) limit when patient is positioned in normal orientation. The maximum safe patient weight on this table for standard surgical positions in normal orientation is 1,000 lb (452 kg) with floor locks locked.
- Do not use this table for patients exceeding the 500-lb (226-kg) limit when patient is positioned in reversed orientation. The maximum safe patient weight on this table for the standard surgical positions in reversed orientation is 500 lb (226 kg) with floor locks locked.
- When performing surgery requiring a headrest accessory in reversed patient orientation, or when using a Fem/Pop board or the 3080/3085 Ortho Extension accessory, do not exceed 400 lbs (181 kg) patient weight.

The Amsco® 3085 SP™ Surgical Table is designed to safely support a 1,000-lb (452-kg) patient in the normal orientation **only** with limited posturing, or a 500-lb (226-kg) patient in the reversed orientation.

- Refer to the following Sections and Figures 2-2 and 2-3 for Precautionary Tipping recommendations, typical Patient Positioning, and Maximum Weight Limitations.
- Accessories may have a specified lesser weight limitation than the table. Do not exceed the lowest weight limit, table or accessory.
- For patient weights exceeding 500 lb (226 kg), do not use an accessory that has no labeled weight limit. Accessories available for patient weights exceeding 500 lb (226 kg) will be labeled as such with the allowable limit.
- Always check patient stability when patient is positioned.

IMPORTANT: When normal patient loads exceed 700 lb (318 kg), note the following:

- Reflex and Return-to-Level articulations may be slow or not operate. Use other articulations to move the table tops to the desired position.
- Moving the table from an extreme Right Tilt may require the table tops be level. When normal patient loads exceed 900 lb (408 kg), moving the table from an extreme Right Tilt may be slow or not operate.

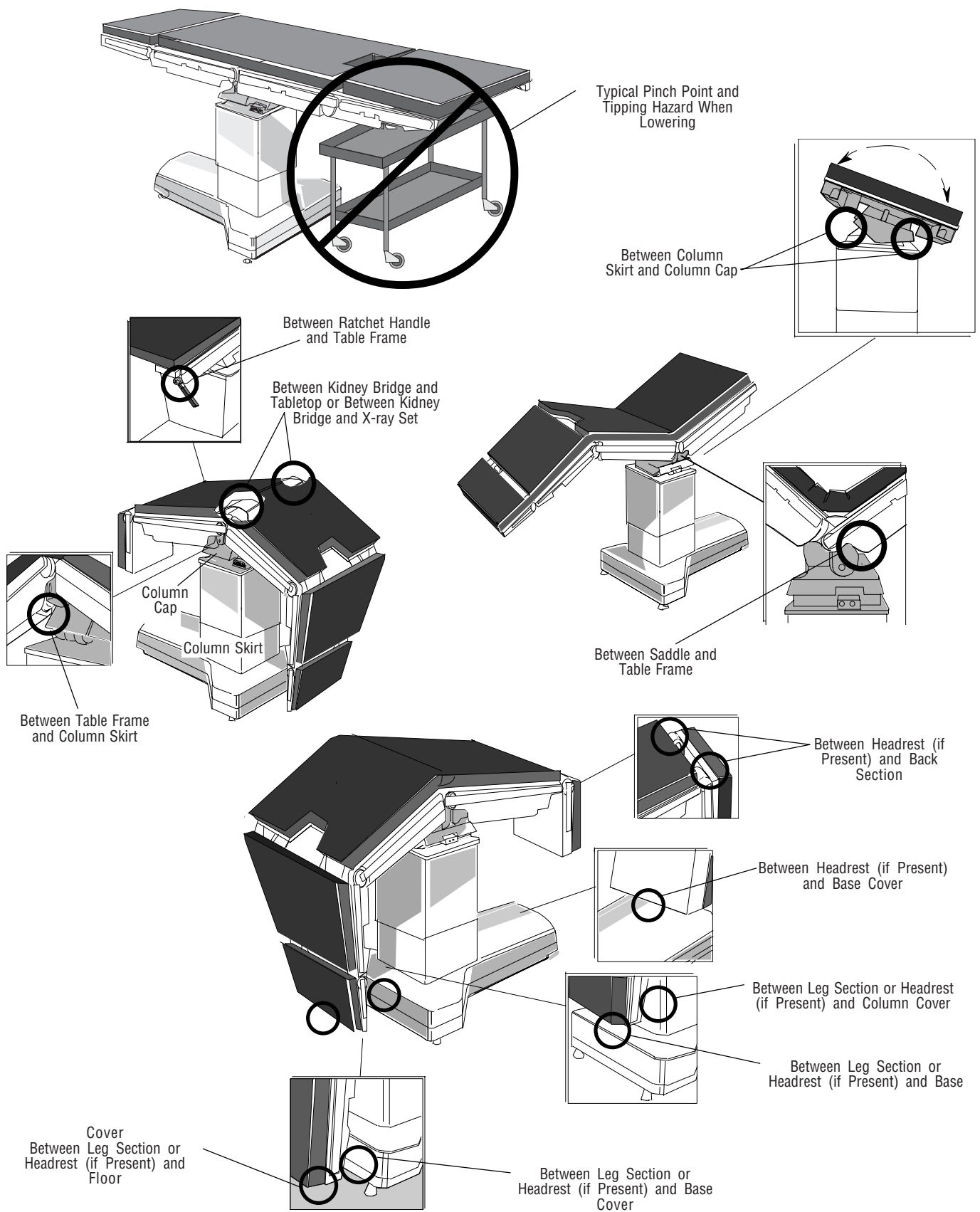

Figure 2-1. Pinch Points

2.2.1 Prevent Possible Tipping



WARNING – TIPPING HAZARD:

- Do not use this table for patients exceeding the 1,000-lb (452-kg) limit when patient is positioned in normal orientation. The maximum safe patient weight on this table for standard surgical positions in normal orientation is 1,000 lb (452 kg) with floor locks locked.
- Fem/Pop Board must be installed into leg section only. Board must be used to support the legs only. It is not intended to support upper body weight.
- Do not use the Fem/Pop Board with patients exceeding 400 lbs (181 kg).

Do not exceed the maximum patient weight indicated in Figures 2-2 and 2-3.

Do not place patient on the table unless floor locks are engaged.

Do not release floor locks while patient is on table.

Do not attempt to move table while patient is on it.

Do not extend (lengthen) the patient support surface beyond that shown, unless using a STERIS table accessory intended for this purpose and the accessory weight limitation is not exceeded.

When using Fem/Pop Board or the 3080/3085 Ortho Extension accessory, do not exceed 400 lbs (181 kg) maximum patient weight.

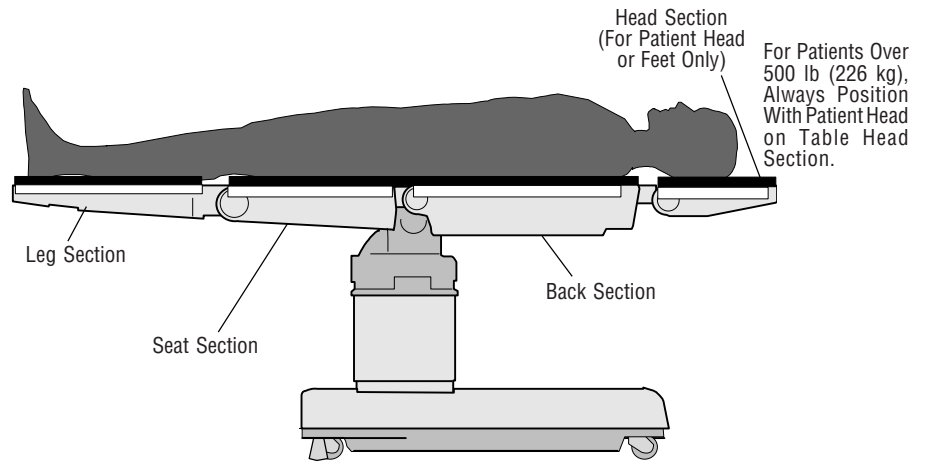

**Figure 2-2. Normal Patient Orientation
(For up to 1,000-lb [452-kg] Patient Weight)**

2.2.2 For Reverse Patient Orientation



WARNING – TIPPING HAZARD:

- Do not use this table for patients exceeding the 500-lb (226-kg) limit when patient is positioned in reversed orientation. The maximum safe patient weight on this table for standard surgical positions in reversed orientation is 500 lb (226 kg) with floor locks locked.
- When performing surgery requiring a headrest accessory in reversed patient orientation, or when using a Fem/Pop board or the 3080/3085 Ortho Extension accessory, do not exceed 400 lbs (181 kg) patient weight.
- Foot Extension Accessory or combination of Foot Extension and Headrest Accessories from previous design STERIS tables must not be used for reverse orientation on the 3085 SP Table.

When performing surgery requiring a headrest accessory in a reversed patient orientation, do not exceed 400-lb (181 kg) patient weight limit.

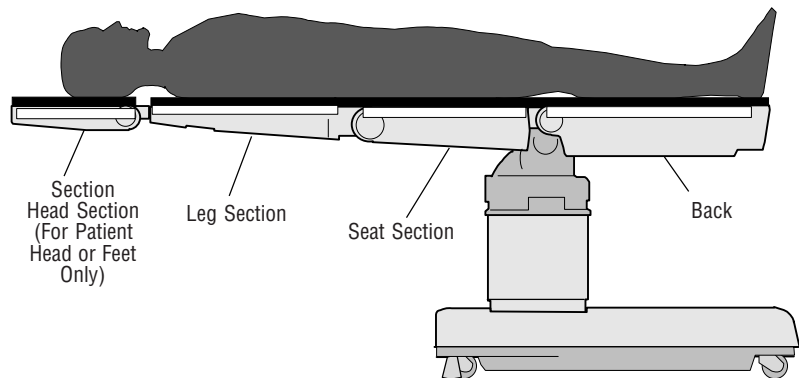

**Figure 2-3. Reverse Patient Orientation
(For up to 500-lb [226-kg] Patient Weight)**

2.2.3 Other Considerations

WARNING – PERSONAL INJURY HAZARD:

- **Health care professionals must ensure patients are positioned and monitored so as to prevent compromising respiration, nerve pathways, or circulation.**
- **There is a 1,000-lb (452-kg) patient weight limit if patient is in normal orientation and a 500-lb (226-kg) patient weight limit if patient is in reversed orientation; however, the accessory load rating may be lower. Do not exceed the accessory load rating if it is lower than the table rating.**

Use extreme care when transferring patients to or from table.

Ensure all accessories are properly installed and secured.

Check for and eliminate harmful patient pressure points once patient is positioned.

Have a qualified medical professional monitor patient during surgery for all possible patient positioning hazards.

2.3 General Description

CAUTION – POSSIBLE EQUIPMENT DAMAGE:

- **For ORCS equipped tables, use the HERMES®-Ready¹ or ACT Enabled 3085 SP hand control with the blue strain relief on the plug. The standard 3085 SP hand control has a red strain relief on the plug. *These two hand controls are not interchangeable.***
- **The HERMES®-Ready¹ and ACT Enabled hand controls are interchangeable for control of table functions; however, ORCS voice-activation control will NOT operate properly with improper hand control.**

Amsco 3085 SP Surgical Tables are remote control, Image Amplification compatible units with auxiliary override (backup) systems for the control and hydraulic systems. Tables are furnished with 2" (51 mm) thick pads and are available in the following two configurations:

- Electric Powered
- Battery Powered

Both tables are operated in the same manner.

*NOTE: Two hand controls are available: The standard hand control unit (with a **red** strain relief on the plug) is for standard tables; the Operating Room Control System (ORCS) hand control (with a **blue** strain relief on the plug) is for tables equipped with either the HERMES®-Ready¹ or ACT Enabled™ interface control options. **The hand controls are not interchangeable.***

Image Amplification Coverage

Head End – 28" (711 mm) with headrest attached (plus 3" [76 mm] maximum extension of headrest).

Foot End – 33" (838 mm) without headrest attached.

– 45" (1,143 mm) with headrest attached (no extension of headrest allowed when at this end).

Width – 14.5" (368 mm) average on both ends.

¹HERMES-Ready is a registered trademark of Computer Motion.

2.4 Technical Specifications

2.4.1 Overall Size (WxLxH) 24-13/32 x 75-15/16 x 27 to 44"
(620 x 1,928 x 686 to 1,118 mm)

2.4.2 Weight 737 lbs (334 kg); maximum anticipated floor lock pressure exerted on floor: 380 psi (2,619 KPa) with a 500-lb (226-kg) patient load, 440 psi (3,033 KPa) with a 1,000-lb (452-kg) patient load.

2.4.3 Utility Requirements **Electric:***

- 100 V, 5 A, 1-Phase
- 120 V, 4.5 A, 1-Phase
- 220 V, 3 A, 1-Phase
- 230/240 V, 2.5 A, 1-Phase

** Each table is shipped from the factory configured to the electrical requirement specified on the factory order. If required to be changed in the field, consult STERIS for the procedure/materials required. Tables intended to be shipped to other than USA or Canada will have procedure/materials included in shipping container.*

 **WARNING – PERSONAL INJURY HAZARD:** If the integrity of the external protective earth conductor installation or arrangement is in doubt, operate the table from its internal power source.

 **WARNING – EXPLOSION HAZARD:** Table must not be used in the presence of flammable anesthetics.

 **WARNING – TRIPPING HAZARD:** Route power cord to receptacle in a position so it will not be tripped over by personnel in the area.

 **CAUTION – POSSIBLE EQUIPMENT DAMAGE:**

- When moving the table to point of use, roll it carefully at moderate speed and only over smooth floors. Maximum floor clearance is 1/4" (6 mm). Avoid door jams, elevator jams, and obstructions greater than 1/4" (6 mm). If necessary, lift uncrated table over obstructions, onto trucks, etc. Lift table evenly and only by the table base. **DO NOT** transport articles (including accessories) on top of the table and **DO NOT** use a fork-lift to move the uncrated table.
- The table has internal switches for setting to various AC input voltages. Improper setting of switches may damage table electrical system and/or cause improper operation of the table.

NOTE: Patient grounding post/potential equalization terminal (male connector, DIN 42801) is provided. Mating female connector is not furnished by STERIS.

IMPORTANT: Before connecting the table to your AC power system, check that table internal voltage switches are set for your power system (100, 120, 220, or 230/240).

IMPORTANT: Battery powered tables should be completely charged prior to initial operation. Charge batteries as indicated in **SECTION 6, ROUTINE MAINTENANCE**, before proceeding.

If table is to be placed in extended storage, have table prepared for storage by a qualified service technician. Ensure batteries are disconnected and check batteries before reconnecting. Every six months the table must be operated through all articulations and the batteries charged.

3.1 Install and Route Power Cord



WARNING – TRIPPING HAZARD: Route the power cord to the receptacle in a position so it will not be tripped over by personnel in the area.

1. Place table at desired location.

NOTE: Omit Steps 2 and 3 if table is battery-powered.

2. Connect female end of 20' (6 m) long power cord* to male connector located on narrow end of table base (can only be connected one way). See Figure 3-1.
3. Route power cord to wall receptacle so it will not be tripped over, then plug it into an appropriate receptacle.
4. For either electric-powered or battery-powered 3085 SP, power cord may remain plugged into appropriate receptacle indefinitely. It will not harm table or table batteries.

* *The Australian medical power cord will be much shorter.*

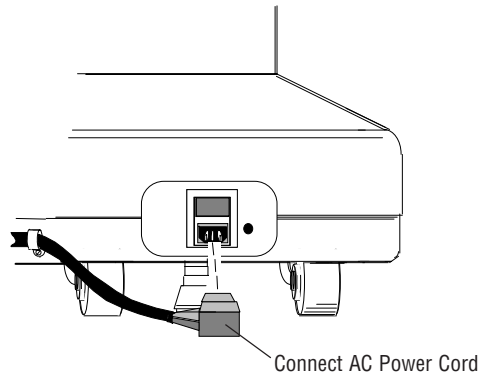

Figure 3-1. Power Cord Connection (Electric Table Only)

3.2 Install Hand Control and Lock Table in Place

3.2.1 Standard 3085 SP Tables Hand Control



CAUTION – POSSIBLE EQUIPMENT DAMAGE:

- For ORCS equipped tables, use the HERMES®-Ready¹ or ACT Enabled 3085 SP hand control with the blue strain relief on the plug. The standard 3085 SP hand control has a red strain relief on the plug. *These two hand controls are not interchangeable.*
- The HERMES®-Ready¹ and ACT Enabled hand controls are interchangeable for control of table functions; however, ORCS voice-activation control will NOT operate properly with improper hand control.

3.2.2 Operating Room Control System (ORCS) Hand Control



CAUTION – POSSIBLE EQUIPMENT DAMAGE:

- For ORCS equipped tables, use the HERMES®-Ready¹ or ACT Enabled 3085 SP hand control with the blue strain relief on the plug. The standard 3085 SP hand control has a red strain relief on the plug. *These two hand controls are not interchangeable.*
- The HERMES®-Ready¹ and ACT Enabled hand controls are interchangeable for control of table functions; however, ORCS voice-activation control will NOT operate properly with improper hand control.

Connect the hand control plug to the proper table receptacle.

NOTE: A spring-loaded lock ring locks plug into receptacle. When disconnecting the hand control, pull back on the lock ring before pulling the plug from the receptacle.

Align the red dot on the hand control cord red plug with the red dot of the table red receptacle and push into connected position (see Figure 3-2).

*NOTE: The standard hand control and the ORCS hand control (for tables equipped with either HERMES®-Ready¹ or ACT Enabled™ interface control options) are **not interchangeable**.*

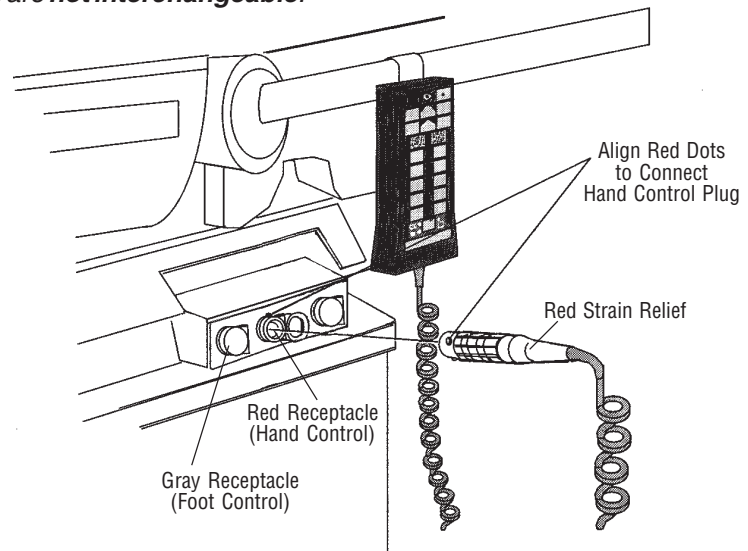

Figure 3-2. Hand Control Connection for Standard 3085 SP Table

Align the red dot on the hand control cord and the blue plug with the red dot of the table blue receptacle, and push into connected position (see Figure 3-3).

*NOTE: The standard hand control and the ORCS hand control (for tables equipped with either HERMES®-Ready¹ or ACT Enabled™ interface control options) are **not interchangeable**.*

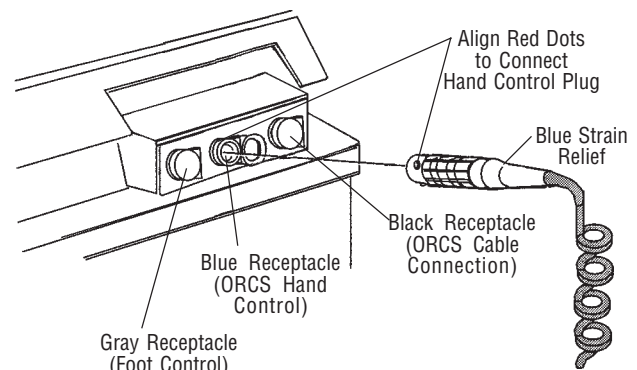

Figure 3-3. Hand Control Connection for ORCS Equipped 3085 SP Table

¹HERMES-Ready is a registered trademark of Computer Motion.

3.2.3 Lock Table in Place

1. Press **ON** button at top of hand control to turn table on. All LEDs on hand control may light momentarily for control system self-test when power is turned on.

Refer to Figure 3-4 for identification of hand control functions. See *SECTION 7, TROUBLESHOOTING*, to identify any problems with the hand control.

NOTE: If the wrong function selection button is accidentally pressed, press the correct function button to override the incorrect selection.

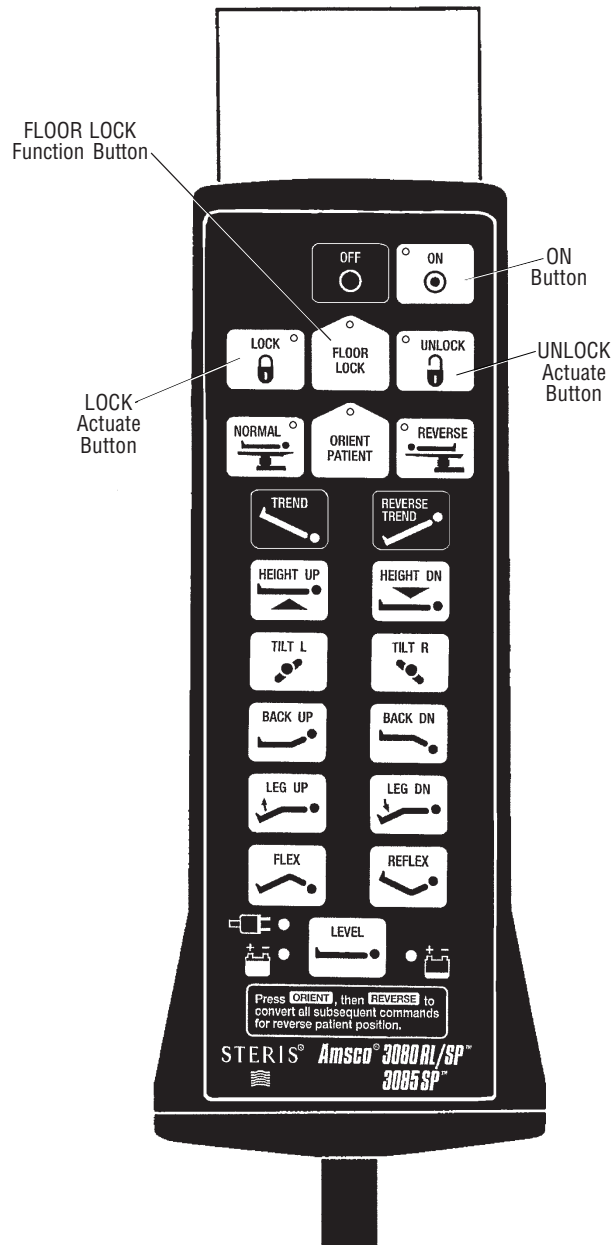

Figure 3-4. Standard Hand Control

⚠ CAUTION – POSSIBLE EQUIPMENT DAMAGE:

- Hang hand control from side rail (or end rail) of table when not in use to avoid possible damage to the control.
- Route the hand control cord (and optional HERMES®-Ready¹ or ACT Enabled™ interface cord and/or optional foot control cord, if applicable) clear of any pinch points where the cord(s) could be damaged.

2. Press **FLOOR LOCK** Function button in center row of control buttons, and **within five seconds** press **LOCK** button (to the left of **FLOOR LOCK** button, see Figure 3-4). Table is locked in position as floor locks are lowered and casters are raised. Table will remain locked (immobile) until **UNLOCK*** function is actuated.

NOTE: The tripodal floor locks are self-compensating for floor irregularities of up to 1/4" (6 mm), and should not require adjustment. Floor locks should engage simultaneously and the table base should rise evenly. Casters should swing freely when the table is in the LOCKED position.

3. Hang hand control on table side rail or end rail (see Figure 3-2) and route control cord away from possible pinch points.
4. Check floor locks to ensure each is snug against floor (see Figure 3-5).

IMPORTANT: If table was in storage for longer than four weeks, operate table through all articulations prior to usage.

* To unlock table, press the **FLOOR LOCK** button in the center row of control buttons, and within five seconds press the **UNLOCK** button adjacent to it on the right (see Figure 3-4). Floor locks will retract and table will rest on casters.

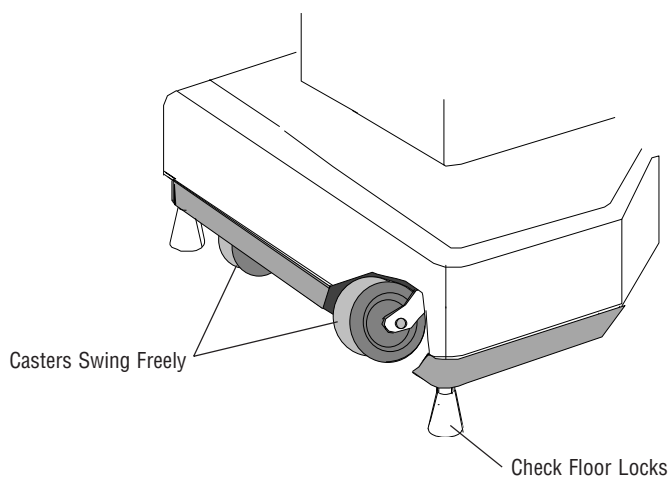

Figure 3-5. Check Floor Locks

¹HERMES-Ready is a registered trademark of Computer Motion.

3.3 Hand Control Interchangeability

⚠ CAUTION – POSSIBLE EQUIPMENT DAMAGE: The HERMES®-Ready¹ and ACT Enabled hand controls are interchangeable for control of table functions; however, ORCS voice-activation control will NOT operate properly with improper hand control.

The 3080 RL, 3080 SP, and 3080 RL/SP/3085 SP hand control will plug into and operate the 3080 RL, 3080 SP, and 3085 SP tables. However, note the following exceptions:

- The 3080 RC hand control will plug into and operate the 3080 RL, 3080 SP, and 3085 SP in a normal fashion EXCEPT *there is no Return-to-Level button.*
- The 3080 RL, 3080 SP, and 3080 RL/SP/3085 SP hand control will plug into and operate the 3080 RC EXCEPT *the 3080 RC does not have the Return-to-Level capability.*
- The standard hand control (for the 3080 RC, 3080 RL, 3080 SP or 3085 SP tables) has a six pin plug. The Operating Room Control System (ORCS) hand control (for either 3085 SP HERMES®-Ready¹ or ACT Enabled™ table) has a different plug (18 pins) and cannot be plugged into or used on any 3080 or 3085 table except HERMES®-Ready¹ or ACT Enabled™ 3085 SP tables.

4.1 Attach Headrest and Orient Patient

WARNING – EXPLOSION HAZARD: Table must not be used in the presence of flammable anesthetics.

WARNING – TIPPING HAZARD:

- Do not place patient on the table unless floor locks are engaged.
- Do not release floor locks while patient is on table.

WARNING – PERSONAL INJURY HAZARD: If the integrity of the external protective earth conductor installation or arrangement is in doubt, operate the table from its internal power source.

For maximum patient positioning flexibility, the Amsco® 3085 SP™ Surgical Table is designed so the headrest can be attached to either end of the table.

IMPORTANT: Control must be oriented as to the patient's position on table before any positioning functions are operable. When the table is turned on with the hand control, it will automatically activate in NORMAL patient orientation. The user can then select REVERSE orientation if desired.

NOTE: Thumbscrews located under tabletop frame must be loosened before headrest can be attached or removed.

1. Determine desired patient position and attach headrest to table end to obtain this desired position (see Figure 4-1) as follows:

NOTE: The headrest (head section) is intended only to support the patient head or feet. Load rating is 77 lb (35 kg).

- a. Insert rods extending from each side of headrest attachment into bores provided in either end of table frame.
- b. Reach under tabletop frame and fully tighten both thumbscrews (one on each side of frame) to secure headrest attachment in place. Refer to SECTION 4.4, HEADREST POSITIONING, for adjustment procedures.

2. Verify power is ON and table floor locks are properly engaged.

NOTE: If the wrong function selection button is accidentally pressed, press the correct function button to override the incorrect selection.

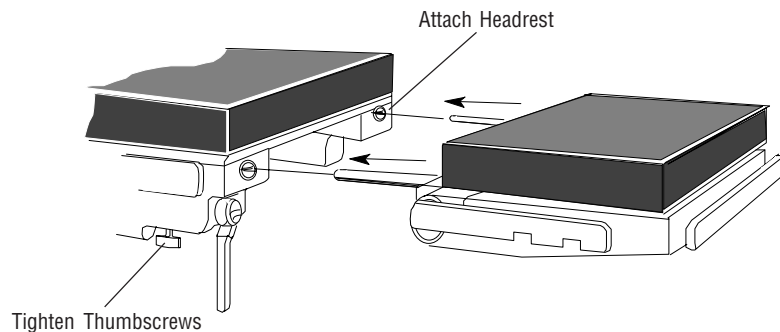

Figure 4-1. Attach Headrest

WARNING – TIPPING HAZARD:

- Do not use this table for patients exceeding the 1,000-lb (452-kg) limit when patient is positioned in normal orientation. The maximum safe patient weight on this table for standard surgical positions in normal orientation is 1,000 lb (452 kg) with floor locks locked.
- Do not use this table for patients exceeding the 500-lb (226-kg) limit when patient is positioned in reversed orientation. The maximum safe patient weight on this table for the standard surgical positions in reversed orientation is 500 lb (226 kg) with floor locks locked.
- When performing surgery requiring a headrest accessory in reversed patient orientation, or when using a Fem/Pop board or the 3080/3085 Ortho Extension accessory, do not exceed the 400 lb (181 kg) patient weight.

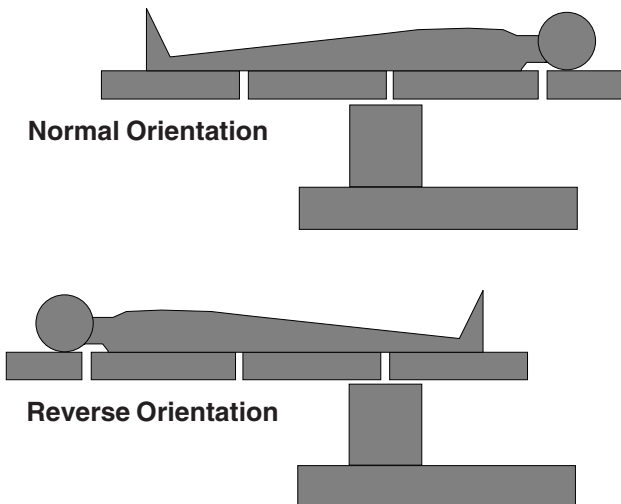

Figure 4-2. Patient Orientation

3. Press **ORIENT PATIENT** Function button in center row of buttons on hand control and **within five seconds** (while LED is still lit), press appropriate Actuate button (**NORMAL** or **REVERSE**) to indicate orientation of patient's head on table (see Figures 4-2 and 4-3).

*NOTE: Activation of the **ORIENT PATIENT** function automatically translates all subsequent commands from the hand, foot, and optional Operating Room Control System (ORCS) controls, so that they correspond correctly to where the indicated patient's head is on the table. For example, when the **REVERSE** Actuate button is activated, the direction of the Trendelenburg and Side Tilt articulations is automatically reversed, and the Back and Leg articulations are likewise adjusted so each part of the patient's anatomy is positioned correctly when the patient is reversed on the tabletop. The anesthesiologist does not have to think backward to adjust for the reverse orientation of the patient.*

If the control is turned OFF or power is lost while the "reverse" orientation is activated, when the table control is turned ON again, the control automatically reverts to "normal" orientation.

IMPORTANT: When "Reverse" patient orientation is selected, the Flex and Reflex articulation functions are disabled. Also, refer to *SECTION 2* for patient positioning and weight limitation.

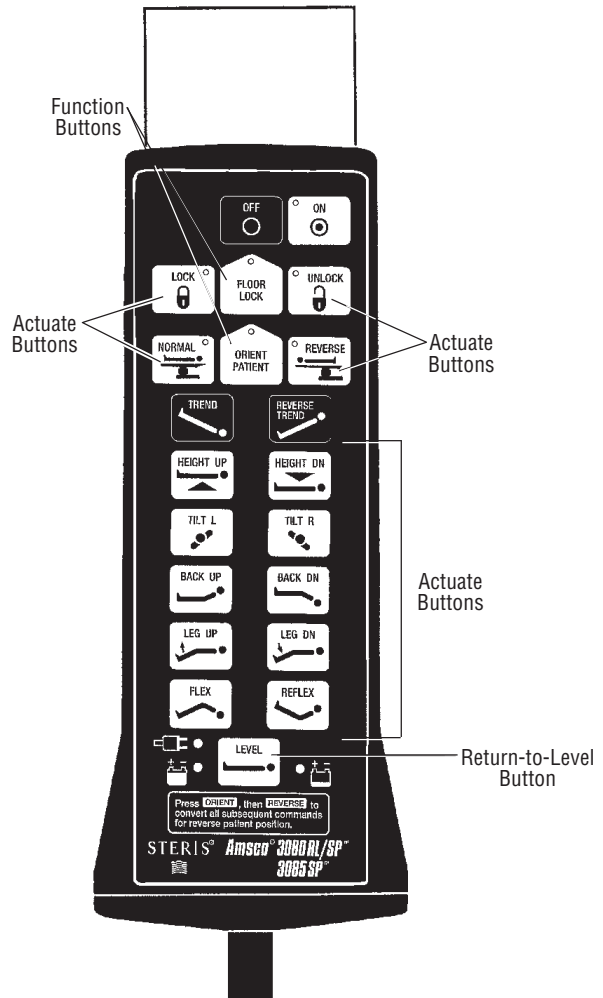



Figure 4-3. Hand Control

4.2 Tabletop Positioning

 **WARNING – PINCHING HAZARD:** Pinch points are created during extreme tabletop articulation. Carefully review illustrations in Figure 2-1 before operating the table.

 **WARNING – PINCHING AND TIPPING HAZARD:** Patient injury may result if the operator of this table is not completely familiar with the controls for patient positioning and table operation.

 **WARNING – PERSONAL INJURY HAZARD:**

- Health care professionals must ensure patients are positioned and monitored to prevent compromising respiration, nerve pathways, or circulation.
- Unanticipated table movement could cause patient injury. Patient must be secured to the table in accordance with recommended positioning practices.

The tabletop may be articulated within the limits shown by use of the hand control positioning buttons or the optional foot control positioning pedals, or by the optional ORCS System. If these controls fail to function, refer to *SECTION 7, TROUBLESHOOTING*, to see if the problem can be quickly determined and corrected. If problem is not readily apparent, table may continue to be operated per procedures outlined in *SECTION 5, AUXILIARY OVERRIDE SYSTEMS*. Headrest position and kidney bridge elevation must be adjusted manually as outlined later in this section.

NOTE: Battery-powered tables should be switched OFF after each procedure to prevent unnecessary battery discharge. If low battery condition is indicated by the hand control LED, refer to SECTION 6 for Battery Charging Procedure.

The table will continue to function normally for at least 24 hours after the BATTERY DOWN LED (see SECTION 1, DEFINITION OF SYMBOLS) first illuminates. If the LED illuminates during a procedure, complete the procedure and recharge the batteries at the end of the day. If the BATTERY DOWN LED is flashing, immediately connect the AC power cord to the table base and plug into an appropriate AC receptacle (see Figure 6-3).

4.2.1 Hand Control Operation

NOTE: See SECTION 7, TROUBLESHOOTING, to identify problems as indicated by red LEDs on the hand control.

 **CAUTION – POSSIBLE EQUIPMENT DAMAGE:**

- Hang hand control from side rail (or end rail) of table when not in use to avoid possible damage to the control.
- Route the hand control cord (and optional HERMES®-Ready¹ or ACT Enabled™ interface cord and/or optional foot control cord, if applicable) clear of any pinch points where the cord(s) could be damaged.

The following functions must be completed before any positioning functions are operable:

- Control turned ON.
- Floor locks engaged.

¹HERMES-Ready is a registered trademark of Computer Motion.

Adjust the tabletop position by using the hand control positioning buttons, as follows (see Figure 4-3):

1. Press **FLOOR LOCK** Function button in center row of buttons on hand control and **within five seconds** (while LED is still ON), press desired Actuate button (**LOCK** or **UNLOCK**) adjacent to it.
2. Press **ORIENT PATIENT** Function button in center row of buttons, and **within five seconds** (while LED is still ON), press desired Actuate button (**NORMAL** or **REVERSE**) adjacent to it to indicate patient orientation on table.

If no selection is made, table will default to **NORMAL** orientation.

3. Press desired positioning Actuate button.
4. When desired position has been reached, release positioning Actuate button to automatically stop tabletop and lock it in position.
5. Range of nominal tabletop movements is as follows:

- **Trendelenburg** (**TREND** button) – 25° maximum from horizontal.
- **Reverse Trendelenburg** (**REVERSE TREND** button) – 25° maximum from horizontal.
- **Height** (**HEIGHT UP** and **HEIGHT DN** buttons) – 27" (686 mm) minimum to 44" (1118 mm) maximum.
- **Side Tilt** (**TILT L** and **TILT R** buttons) – 18° maximum to right or to left of horizontal.

NOTE: Momentary delay may occur when activating Side Tilt while the safety mechanism disengages the tilt-lock function.

- **Back** (**BACK UP** and **BACK DN** buttons) – up 55° maximum (80° in REVERSE orientation) or down 25° maximum (105° in REVERSE orientation) from horizontal.
- **Leg** (**LEG UP** and **LEG DN** buttons) – up 80° maximum (55° in REVERSE orientation) or down 105° maximum (25° in REVERSE orientation) from seat section.

NOTE: FLEX and REFLEX position controls are disabled when in REVERSE patient orientation.

- **Flex** (**FLEX** button) – back section down 20° maximum with seat section down 25° maximum from horizontal.
- **Reflex** (**REFLEX** button) – back section up 25° maximum with seat section up 35° maximum from horizontal.
- **Return To Level** – tabletop can be returned to level by pressing **LEVEL** button. Table will move in gradual, anatomically correct increments until it reaches level.

NOTE: If the LEVEL button is pressed while the green LED on the ORIENT PATIENT Function button is still lit, the table will not return to level. Wait for completion of the orient patient function (maximum five seconds) before pressing the LEVEL button to activate the return-to-level function.

IMPORTANT: For table positioning when patient load exceeds average weights, note the following:

- 1) When a normal patient load exceeds 700 lb (318 kg), Reflex and Return-to-Level articulations may be slow or not operate. Use other articulations to move the tabletops to the desired position.

WARNING – TIPPING

HAZARD: During an articulation if the tabletop sections contact an obstruction, the table may tip. Before lowering either the tabletop or individual sections, remove possible obstructions. Do not allow leg section, when lowered, to contact the floor.

CAUTION – POSSIBLE EQUIPMENT DAMAGE:

- During some extreme articulations, the tabletop may contact the base and/or column shrouds. Take care to avoid positioning the table in such a way as to cause damage to the shrouds.
- Use caution when raising the seat section or back section while the kidney bridge is elevated. The section may contact the elevated kidney bridge and damage the bridge and/or section.

- 2) When a normal patient load exceeds 700 lb (318 kg), moving the table from an extreme Right Tilt may require the tabletops be level. When normal patient load exceeds 900 lb (408 kg), moving the table from an extreme Right Tilt may be slow or not operate.
- 3) When a reversed patient load exceeds 400 lbs (181 kg), certain articulations may be much slower than with a lighter load; for example, Reversed Trendelenburg articulating. Additionally, when using X-ray tops with bariatric patients, the automatic return-to-level function may not respond until first initiating an independent articulation.

4.2.2 Optional Foot Control Operation

An optional foot control assembly is available for use in conjunction with the hand control. See Figure 4-4 for identification of foot control functions.

NOTE: Battery-powered tables should be switched OFF after each procedure to prevent unnecessary battery discharge. If a low battery condition is indicated by the hand control BATTERY DOWN LED, refer to SECTION 6 for Battery Charging Procedures.

WARNING – PERSONAL INJURY HAZARD:

- Unanticipated table movement could cause patient injury. Patient must be secured to the table in accordance with recommended positioning practices.
- Do not immerse any part of foot control in liquids; this could cause unanticipated table movement, leading to patient injury. Always cover control with a plastic bag before using.

CAUTION – POSSIBLE EQUIPMENT DAMAGE: Route the hand control cord (and optional HERMES®-Ready¹ or ACT Enabled™ interface cord and/or optional foot control cord, if applicable) clear of any pinch points where the cord(s) could be damaged.

1. The following must be completed before any foot control positioning functions are operable:

- Hand control connected.
- Control turned ON.
- Floor locks engaged.
- ORIENT PATIENT button activated (green LED ON) to indicate patient's position on table (see Figures 4-2 and 4-3).

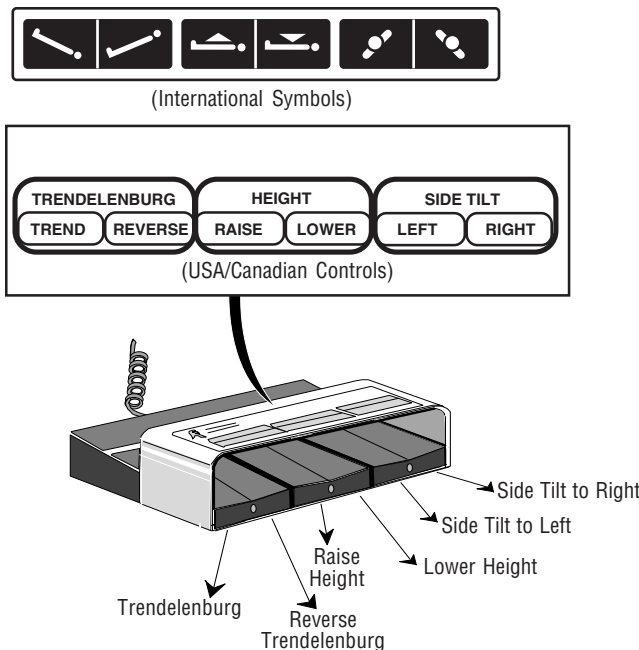

Figure 4-4. Foot Control

¹HERMES-Ready is a registered trademark of Computer Motion.

WARNING – TIPPING HAZARD: During an articulation if the tabletop sections contact an obstruction, the table may tip. Before lowering either the tabletop or individual sections, remove possible obstructions. Do not allow leg section, when lowered, to contact the floor.

CAUTION – POSSIBLE EQUIPMENT DAMAGE:

- During some extreme articulations, the tabletop may contact the base and/or column shrouds. Take care to avoid positioning the table in such a way as to cause damage to the shrouds.
- Use caution when raising the seat section or back section while the kidney bridge is elevated. The section may contact the elevated kidney bridge and damage the bridge and/or section.

2. Connect foot control assembly to table by aligning foot control cord gray plug red dot with table gray receptacle red dot, and pushing plug into connected position (see Figure 4-5).

NOTE: For foot control, note the following:

- 1) A spring-loaded lock ring locks plug into receptacle. When disconnecting foot control, pull back on lock ring before pulling plug from receptacle.
 - 2) If foot control and hand control are actuated simultaneously, hand control has priority.
3. Adjust tabletop position using foot control positioning pedals, as follows (see Figure 4-4):

• **Trendelenburg** – 25° maximum from horizontal.

Depress left side (labeled **TREND**) of TRENDELENBURG pedal (located in the left position of foot control pedals) and release pedal when desired position has been reached to automatically stop tabletop and lock it in position.

• **Reverse Trendelenburg** – 25° maximum from horizontal.

Depress right side of TRENDELENBURG pedal (located in the left position of foot control pedals) and release pedal when desired position has been reached to automatically stop tabletop and lock it in position.

• **Raise Height** – 44" (1,118 mm) maximum.

Depress left side of HEIGHT pedal (located in the center position of foot control pedals) and release pedal when desired position has been reached to automatically stop tabletop and lock it in position.

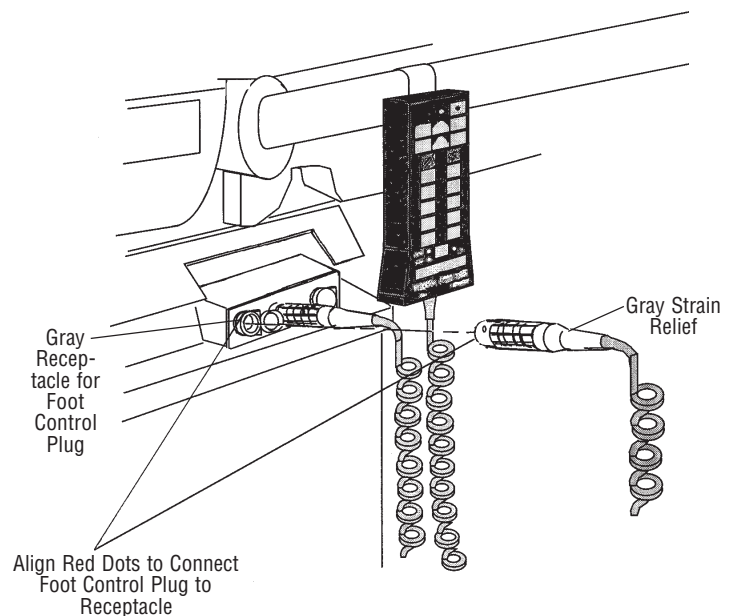

Figure 4-5. Foot Control Connection

- **Lower Height** – 27" (686 mm) minimum.

Depress right side of HEIGHT pedal (located in the center position of foot control pedals) and release pedal when desired position has been reached to automatically stop tabletop and lock it in position.

- **Side Tilt to Left** – 18° maximum from horizontal.

Depress left side of SIDE TILT pedal (located in the right position of foot control pedals) and release pedal when desired position has been reached to automatically stop tabletop and lock it in position.

- **Side Tilt to Right** – 18° maximum from horizontal.

Depress right side of SIDE TILT pedal (located in the right position of foot control pedals) and release pedal when desired position has been reached to automatically stop tabletop and lock it in position.

NOTE: Momentary delay may occur when activating side tilt while the safety mechanism disengages tilt-lock function.

IMPORTANT: For table positioning, when patient load exceeds average weights, note the following:

- 1) When a normal patient load exceeds 700 lb (318 kg), Reflex and Return-to-Level articulations may be slow or not operate. Use other articulations to move the tabletops to the desired position.
- 2) When a normal patient load exceeds 700 lb (318 kg), moving the table from an extreme Right Tilt may require the tabletops be level. When normal patient load exceeds 900 lb (408 kg), moving the table from an extreme Right Tilt may be slow or not operate.
- 3) When reversed patient load exceeds 400 lbs (181 kg), certain articulations may be much slower than with lighter loads; for example, Reversed Trendelenburg articulation.

4.2.3 Care of Controls When Not In Use

When not in use both during and between procedures, the hand control should be attached to the table side rail.



CAUTION – POSSIBLE EQUIPMENT DAMAGE: Hang the hand control from the side rail (or end rail) of the table when not in use, to avoid possible damage to the control.

The foot control, if used, should be bagged and placed on the floor near the surgical area. When the foot control is not required for a procedure, it should be unplugged from the table and stored with other accessories until needed. Never store the foot control (or any other objects) on the table base.

4.3 Optional Operating Room Control System (ORCS) Operation

4.3.1 HERMES-Ready System Operation

WARNING – PERSONAL INJURY HAZARD: Unanticipated table movement could cause patient injury. Patient must be secured to the table in accordance with recommended positioning practices.

CAUTION – POSSIBLE EQUIPMENT DAMAGE: Route the hand control cord (and optional HERMES®-Ready¹ or ACT Enabled™ interface cord and/or optional foot control cord, if applicable) clear of any pinch points where the cord(s) could be damaged.

For voice-activation of Amsco 3085 SP Surgical Table functions, either the HERMES®-Ready¹ or ACT Enabled™ Interface System and appropriate hand control are needed.

NOTE: Battery-powered tables should be switched OFF after each procedure to prevent unnecessary battery discharge. If a low battery condition is indicated by the hand control BATTERY DOWN LED, refer to SECTION 6 for Battery Charging Procedures.

A HERMES-Ready Interface System and a HERMES-Ready Hand Control are required for voice-activation of the HERMES-Ready Amsco 3085 SP table functions.

IMPORTANT: Use the HERMES-Ready 3085 SP hand control with the **blue** strain relief. The standard 3085 SP hand control with a **red** strain relief tail on the connector will not connect to the HERMES-Ready table. For proper HERMES System operation, ensure HERMES-Ready table is interfaced with the HERMES System only, not with any other Operating Room Control System.

NOTE: If the HERMES Interface System and the table hand control are actuated simultaneously, the hand control has priority.

1. **The following must be completed before any HERMES Voice-Activated positioning functions are operable:**

- Hand control connected (HERMES-Ready unit with blue tail on connection).
- Control turned ON.
- Floor locks engaged.
- ORIENT PATIENT button activated (green LED ON) to indicate patient's position on table (see Figures 4-2 and 4-3).

2. Connect HERMES Interface System to HERMES-Ready 3085 SP table by aligning HERMES interface cord black plug red dot with red dot of black receptacle on HERMES-Ready table and pushing plug in to complete connection (see Figure 4-6).

NOTE: A spring-loaded lock ring locks the plug into the receptacle. When disconnecting the interface system, pull back on the lock ring before pulling the plug from receptacle.

3. For operating instructions, refer to **HERMES Operating Room Control Center Operating and Maintenance Manual and Appendix** provided with HERMES System.

NOTE: When the HERMES System is powered up and it initially interrogates the table, the HERMES display screen should acknowledge it as the table.

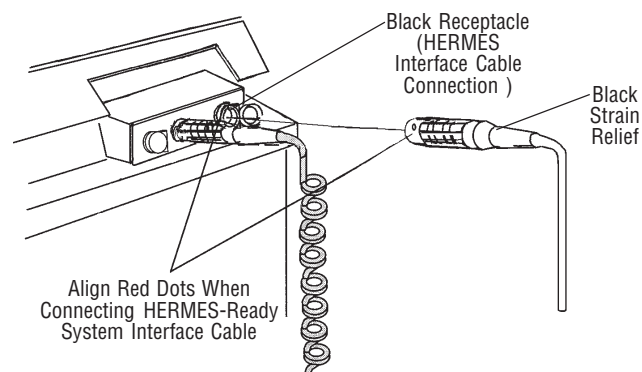

Figure 4-6. HERMES-Ready System Connection

¹HERMES-Ready is a registered trademark of Computer Motion.

4.3.2 ACT Enabled System Operation

An ORCS (not provided by STERIS) and an ACT Enabled Hand Control are required for voice- and/or touch panel-activation of the ACT Enabled Amsco 3085 SP table functions.

NOTE: Battery-powered tables should be switched OFF after each procedure to prevent unnecessary battery discharge. If a low battery condition is indicated by the hand control BATTERY DOWN LED, refer to SECTION 6 for Battery Charging Procedures.

IMPORTANT: Use the ACT Enabled 3085 SP hand control with the **blue** strain relief. The standard 3085 SP hand control with a **red** strain relief tail on the connector will not connect to the ACT Enabled table. For proper ACT voice/touch panel operation, *ensure ACT Enabled table is interfaced with the appropriate Operating Room Control System.* ACT Enabled tables can NOT be controlled by the HERMES system.

NOTE: If the ORCS and the table hand control are actuated simultaneously, the hand control has priority.

- WARNING – PERSONAL INJURY HAZARD:** Unanticipated table movement could cause patient injury. Patient must be secured to the table in accordance with recommended positioning practices.
- CAUTION – POSSIBLE EQUIPMENT DAMAGE:** Route the hand control cord (and optional HERMES®-Ready¹ or ACT Enabled™ interface cord and/or optional foot control cord, if applicable) clear of any pinch points where the cord(s) could be damaged.

1. **The following must be completed before any ACT Enabled Voice-Activated positioning functions are operable:**

- Hand control connected (ACT Enabled unit with blue tail on connection).
- Control turned ON.
- Floor locks engaged.
- ORIENT PATIENT button activated (green LED ON) to indicate patient's position on table (see Figures 4-2 and 4-3).

2. Connect ORCS to ACT Enabled 3085 SP table by aligning ACT Enabled interface cord black plug red dot with red dot of black receptacle on ACT Enabled table and pushing plug in to complete connection (see Figure 4-7).

NOTE: A spring-loaded lock ring locks the plug into the receptacle. When disconnecting the interface system, pull back on the lock ring before pulling the plug from receptacle.

3. For operating instructions, refer to **ACT Enabled Operating Room Control System Operating Manual** provided with that system.

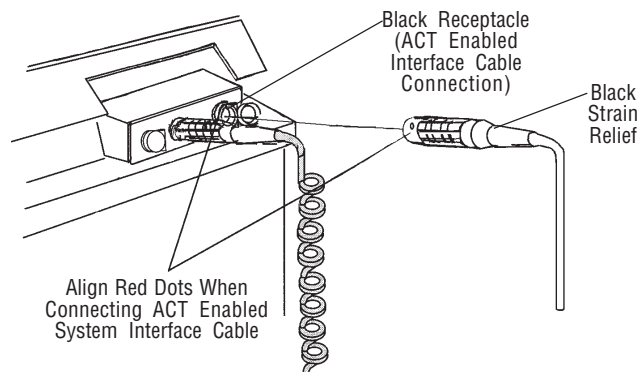

Figure 4-7. ACT Enabled System Connection

¹HERMES-Ready is a registered trademark of Computer Motion.

4.4 Headrest Positioning

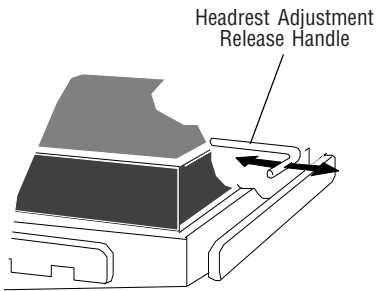

Figure 4-8. Headrest Positioning

The headrest can be attached to either end of table (see Figure 4-1). Headrest is manually adjustable 90° upward and 90° downward from horizontal position. Adjust the headrest to desired position as follows:

1. See Figure 4-8. Locate release handle (under right side of headrest) and pull to release (spring-loaded).
2. Tilt headrest upward or downward to desired position, let go of release handle, then move headrest slightly until ratchet mechanism locks it into position.

4.5 Kidney Bridge Elevation

Kidney bridge elevation is manually adjustable up to a maximum height of 4" (101 mm) above the primary tabletop. Adjust the kidney bridge for desired elevation as follows:

1. Locate kidney bridge ratchet handle (under left side of back section) and flip it down (spring-loaded). See Figure 4-9.

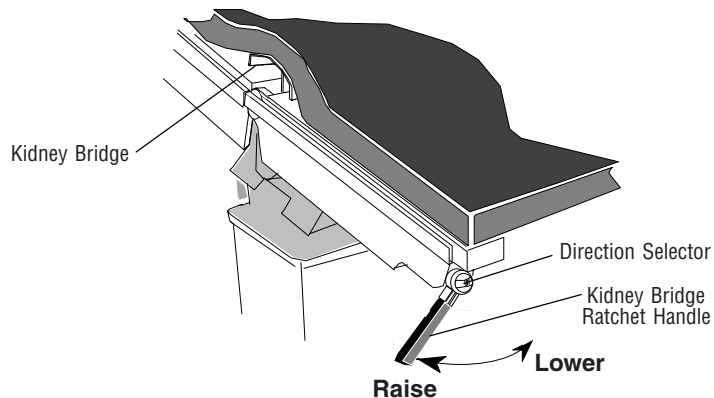

Figure 4-9. Kidney Bridge Adjustment

2. Set ratchet drive directional control for type of ratchet on your table (see Figure 4-10):

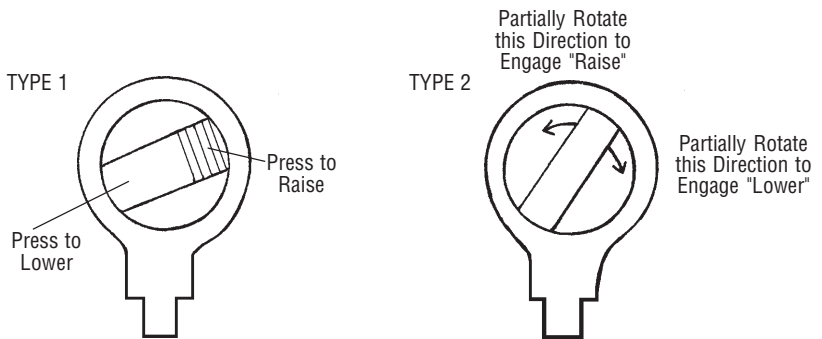

Figure 4-10. Set Ratchet Drive Directional Control

WARNING – INSTABILITY HAZARD: Possible patient or user injury, as well as table or accessory failure, may result from using STERIS table accessories for other than their stated purpose - or from using, on STERIS tables, accessories manufactured and sold by other companies.

WARNING – PERSONAL INJURY HAZARD: When installing any table accessory, check for correct attachment and tighten securely (if appropriate). Do not use worn or damaged accessory. Check installation before using any accessory.

CAUTION – POSSIBLE EQUIPMENT DAMAGE: Use caution when raising the seat section or back section while the kidney bridge is elevated. The section may contact the elevated kidney bridge and damage the bridge and/or section.

Alternately rotate ratchet in drive direction and free-return direction until desired height is reached.

3. Flip ratchet handle back up into stored position when elevation adjustment is complete.

4.6 Pads and Accessories



WARNING – INSTABILITY HAZARD: Possible patient or user injury, as well as table or accessory failure, may result from using STERIS table accessories for other than their stated purpose - or from using, on STERIS tables, accessories manufactured and sold by other companies.



WARNING – PERSONAL INJURY HAZARD: When installing any table accessory, check for correct attachment and tighten securely (if appropriate). Do not use worn or damaged accessory. Check installation before using any accessory.

Mattress pads are backed with hook fastener strips which fasten to companion strips on the tabletop (see Figure 4-11).

Removable accessories are positioned and secured by clamps or sockets which are applied to (and slide along) the side rails. Contact STERIS to order additional table accessories.

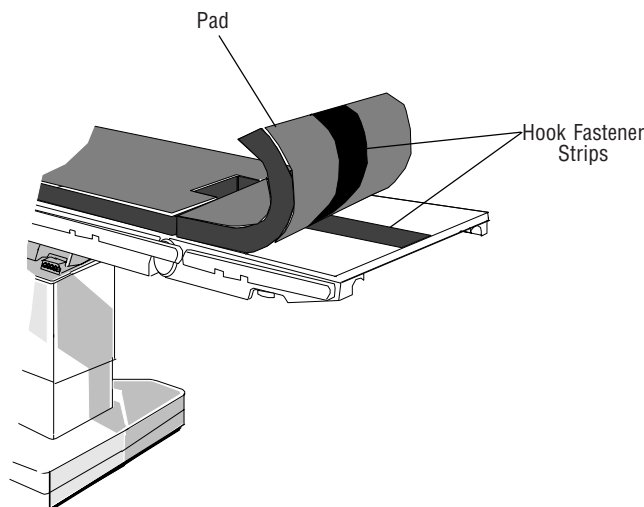

Figure 4-11. Tabletop Pads

4.6.1 Tabletop Pads

1. To install tabletop pad, place pad in position and press hook fastener strips together (see Figure 4-11).
2. To remove, “peel” away from tabletop.

4.6.2 X-ray Top Accessory

A four-section X-ray top accessory is available from STERIS for use with Amsco 3085 SP tables (see Figure 4-12). Each of the top sections has two types of standoff spacers. The shorter spacers rest on the tabletop; the longer, spring-loaded spacers (which secure the X-ray top) fit into tabletop mounting holes. The position of the longer spacers must be adjusted for the table which is to receive the X-ray top.

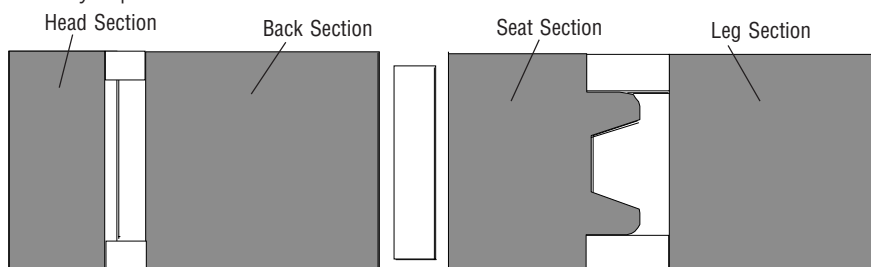

Figure 4-12. X-ray Top Sections

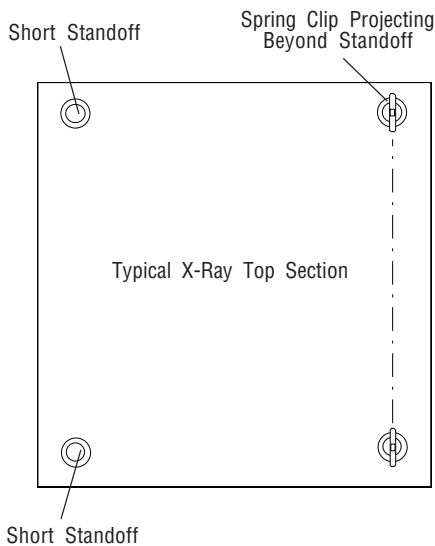

Figure 4-13. X-Ray Top Spring Clips and Standoffs

Perform the following for each X-ray top section:

1. Loosen screws securing spring-loaded spacers to X-ray top section. Position section on table.
2. Rotate spacers so spring clips are in line when viewed from beneath tabletop (see Figure 4-13).
3. Shift X-ray top section until mounting screw shaft on one of spring-loaded spacers is centered in hole in X-ray top section. (A 1/16" [1.6 mm] clearance is provided between each screw shaft and its X-ray mounting hole.)
4. Hold spacer to prevent it from rotating and tighten screw.
5. Ensure remaining spring-loaded spacer is flat against tabletop and center it in its tabletop mounting hole, then tighten screw.

NOTE: When removing an X-ray top section, grasp it at the corners where the spring-loaded spacers are located and lift straight up. Grasping it at the opposite corners will cause the spacers to bind. Repeat the preceding procedure if the spacers bind when section is lifted correctly.

6. Remove replace X-ray top section several times; X-ray top should lift freely.

4.6.3 General Accessories Applied to Side Rails

⚠ WARNING – PERSONAL INJURY HAZARD:

- When installing any table accessory, check for correct attachment and tighten securely (if appropriate). Do not use worn or damaged accessory. Check installation before using any accessory.
- There is a 1,000-lb (452-kg) patient weight limit if patient is in normal orientation and a 500-lb (226-kg) patient weight limit if patient is in reversed orientation; however, the accessory load rating may be lower. Do not exceed the accessory load rating if it is lower than the table rating.

1. To install, place clamp (or socket) on side rail and lock in position with knob (or handle) provided (see Figure 4-14).
2. To remove, loosen knob (or handle) and slide clamp (or socket) along side rail until a notch is reached, then remove clamp (socket).

NOTE: Clamp (socket) may also be removed from end of side rail by raising gravity stops.

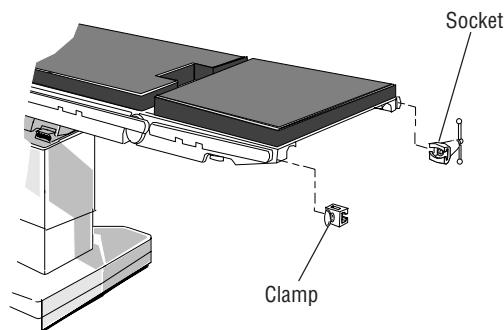

Figure 4-14. General Accessories Applied to Side Rails

4.6.4 Accessories Specific to Amsco 3085 SP Tables



WARNING – PERSONAL INJURY HAZARD: When installing any table accessory, check for correct attachment and tighten securely (if appropriate). Do not use worn or damaged accessory. Check installation before using any accessory.



WARNING – INSTABILITY HAZARD: Patient Transfer Board must be used as a leg support only. It is not intended to support upper body weight of a patient.



WARNING – TIPPING HAZARD:

- Do not use two or more Uro-Endo/Image Amplification Extension Accessories together on the 3085 SP Table.
- Foot Extension Accessory or combination of Foot Extension and Headrest Accessories from previous design STERIS tables must not be used for reverse orientation on the 3085 SP Table.
- When performing surgery requiring a headrest accessory in reversed patient orientation, or when using a Fem/Pop board or the 3080/3085 Ortho Extension accessory, do not exceed the 400 lb (181 kg) patient weight.
- Do not use the Fem/Pop Board with X-ray Tops for bariatric patients.

The following special accessories have been developed specifically for use with the Amsco 3085 SP (see Figure 4-15) and Quantum 3080 tables. These accessories are not intended to be used with any other previous-design STERIS tables.

- **Uro-Endo/Image Amplification Extension** – attaches to back section ONLY. With headrest attached, it provides an additional 8" (203 mm) of I.A. coverage. Without the headrest, for reversed patients, it also expands the Uro-Endo procedure capability of table. Do not use more than one at a time. (Limited to 400-lb [181 kg] patient load.)
- **Patient Transfer Board** – inserts into Uro-Endo/I.A. Extension to support patient's legs during transfer to table. It is intentionally flexible and is intended to be removed after patient is positioned. (Limited to 400-lb [181-kg] patient load.)
- **Drain Tray** – slides onto perineal edge of seat section and Uro-Endo/I.A. Extension. (Not limited to patient weight.)
- **Neuro Seat Plate** – placed under pad by hooking support legs onto side rail supports and allowing to rest on top of kidney bridge. It extends leg seat length and provides for less than 90° seating (with kidney bridge elevated) for unique reversed chair posture. (Limited to 400-lb [181 kg] patient load.)
- **Fem/Pop Board** – intended to be installed into leg section only and used as a leg support for improved lower body I.A. coverage. It is not intended to support upper body weight. Do not use the Fem/Pop Board with X-ray tops for obese patients. (Limited to 400-lb [181 kg] patient load.)
- **X-Ray Tops** – removable cassettes can be inserted through the head, foot, or side of table. (Acceptable for patient loads up to 1,000 lb [452 kg].)
- **3080/3085 Orthopedic Extension** – attaches to seat section to provide a mobile radiolucent orthopedic platform. (Limited to 400-lb [181 kg] patient load.)

The following special accessories have been developed specifically for use with the Amsco 3085 SP and Quantum 3080 tables. These accessories are not intended to be used with any other previous-design STERIS tables.

- **Eye-ENT-Neuro Headrest Adapter** – inserts into the frame headrest bores to permit use of all previous design headrest accessories on the 3085 table. It maintains the same end-of-table relationship for accessories as when used with previous design tables. (Limited to 300-lb [136 kg] patient load.)
- **Eye-ENT-Neuro Headrest Adapter with 4" Extension** – inserts into the frame headrest bores to extend back section an additional 4" (101 mm). (Limited to 300-lb [136 kg] patient load.)
- **Foot Extension** – clamps to side rails at either end of table to provide additional patient support. (Limited to 500-lb [226 kg] patient load.)
- **Perineal Cutout Filler** – attaches to tabletop to cover cutout and provide additional patient support. (Limited to 400-lb [181 kg] patient load.)

For application of other STERIS table accessories to your Amsco 3085 SP table, contact STERIS.

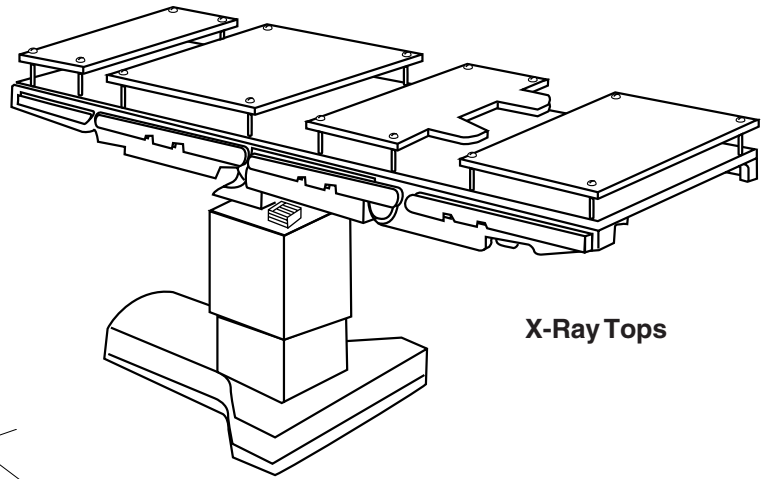

X-Ray Tops

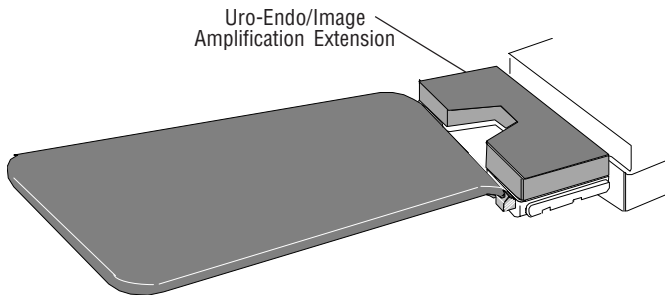

Uro-Endo/Image
Amplification Extension

Patient Transfer Board

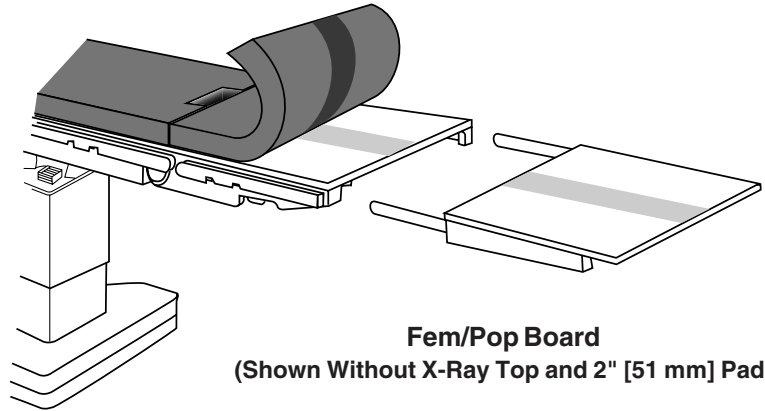

Fem/Pop Board
(Shown Without X-Ray Top and 2" [51 mm] Pad)

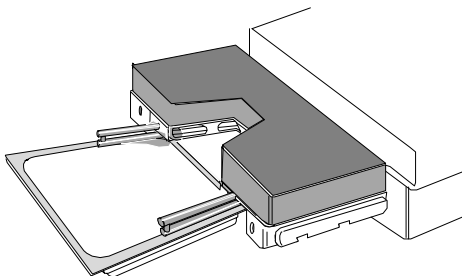

Drain Tray

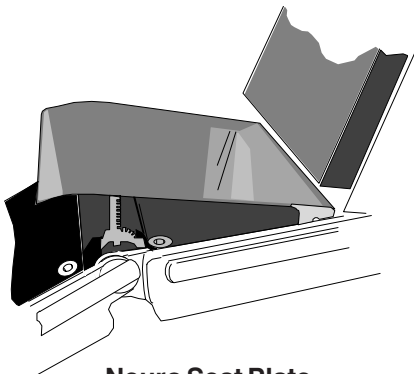

Neuro Seat Plate

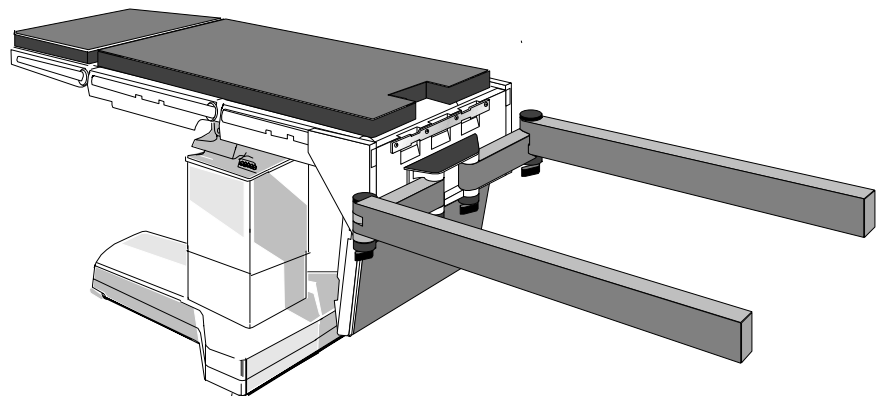



3080/3085 Orthopedic Extension

Figure 4-15. Accessories* for Amsco 3085 Tables

**Contact STERIS for ordering information. Refer to specific accessory descriptions for weight limitations.*

 **WARNING – EXPLOSION HAZARD:** Table must not be used in the presence of flammable anesthetics.

 **WARNING – TIPPING HAZARD:** Do not articulate table with auxiliary override systems unless floor locks are engaged.

 **WARNING – PINCHING AND TIPPING HAZARD:** Patient injury may result if the operator of this table is not completely familiar with the controls for patient positioning and table operation.

The Amsco® 3085 SP™ Surgical Table is equipped with Auxiliary Override Systems that can be actuated at any time and that will allow table operation in the event of primary control malfunction.

Articulate table according to the procedures in **SECTION 5.1, ARTICULATION WITH ELECTRIC PUMP POWER AVAILABLE**, or according to the procedures in **SECTION 5.2, ARTICULATION WITH NO ELECTRIC PUMP POWER AVAILABLE**, if no pump power is available.

Operate the floor lock auxiliary override systems according to the procedures in **SECTION 5.3, FLOOR LOCK OVERRIDE SYSTEMS**.

NOTE: The auxiliary control switches perform ALL functions to correspond to NORMAL patient orientation only. Actuation of any auxiliary switch overrides and shuts down the following:

- Primary hand control,
- Optional foot control,
- Optional HERMES® command capability¹,
- Optional ACT Enabled™ Interface.

Since there are several methods of control for the table, particularly with use of the HERMES® or ACT Enabled™ Systems, it is important to understand the hierarchy of the respective controls' override capability over other control methods.

Table control methods are prioritized, from highest override control to lowest, as follows:

1. Auxiliary Control switches (override all commands from those below).
2. Table Hand Control.
3. ORCS commands (HERMES® or ACT Enabled™ System).
4. Foot Control (no override capability of other controls).

¹HERMES is a registered trademark of Computer Motion.

5.1 Articulation With Electric Pump Power Available

WARNING – PINCHING HAZARD: Pinch points are created during extreme tabletop articulation. Carefully review illustrations in Figure 2-1 before operating the table.

WARNING – TIPPING HAZARD: During an articulation if the tabletop sections contact an obstruction, the table may tip. Before lowering either the tabletop or individual sections, remove possible obstructions. Do not allow leg section, when lowered, to contact the floor.

CAUTION – POSSIBLE EQUIPMENT DAMAGE:

- During some extreme articulations, the tabletop may contact the base and/or column shrouds. Take care to avoid positioning the table in such a way as to cause damage to the shrouds.
- Use caution when raising the seat section or back section while the kidney bridge is elevated. The section may contact the elevated kidney bridge and damage the bridge and/or section.

A row of toggle switches (located on the top of column under the small hood, on the opposite side from the hand control connection; see Figure 5-1) is used for table movements if control power is still available.

Articulate table as follows:

- **Trendelenburg:** 25° maximum from horizontal.

Press **TREND** switch **down** to activate function; release switch when desired position has been reached to automatically stop tabletop and lock it in position.

- **Reverse Trendelenburg:** 25° maximum from horizontal.

Lift **TREND** switch **up** to activate function; when desired position has been reached, release switch to automatically stop tabletop and lock it in position.

- **Height:** 27" (686 mm) minimum to 44" (1118 mm) maximum.

Lift **HEIGHT** switch **up to raise** tabletop or press **down to lower** tabletop; when desired position has been reached, release switch to automatically stop tabletop and lock it in position.

- **Side Tilt:** 18° maximum to right or to left of horizontal.

Lift **SIDE TILT** switch **up to tilt tabletop away** from yourself, or press **down to tilt tabletop toward** yourself; when desired position has been reached, release switch to automatically stop tabletop and lock it in position.

NOTE: A momentary delay may occur when activating the side tilt while the safety mechanism disengages the tilt-lock function.

- **Back:** up 55° maximum or down 25° maximum from horizontal.

Lift **BACK** switch **up to raise** back section or press **down to lower** back section; release switch when desired position has been reached to automatically stop tabletop and lock it in position.

- **Leg:** up 80° maximum or down 105° maximum from horizontal.

Lift **LEG** switch **up to raise** leg section or press **down to lower** leg section; when desired position has been reached, release switch to automatically stop tabletop and lock it in position.

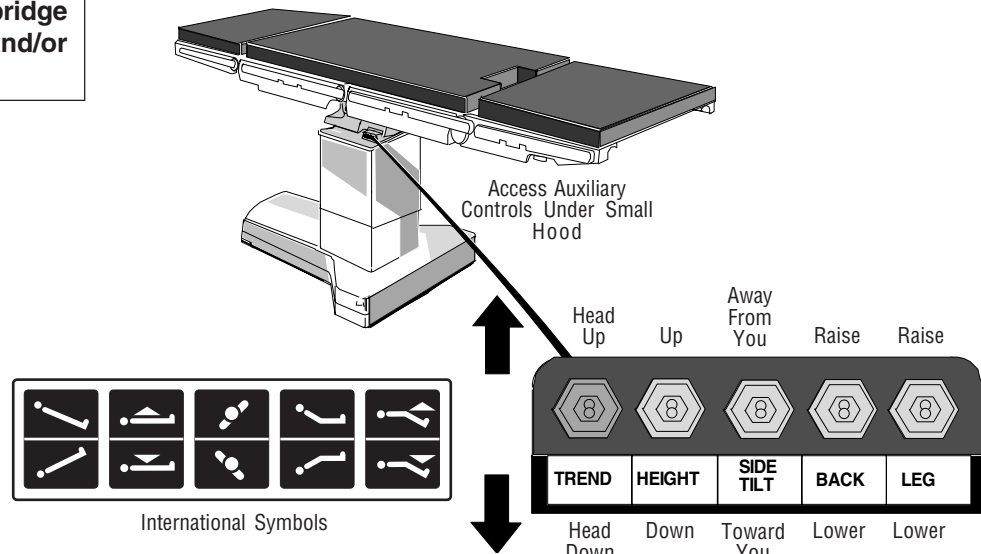

Figure 5-1. Auxiliary Controls (Override Switches)

5.2 Articulation With No Electric Pump Power Available

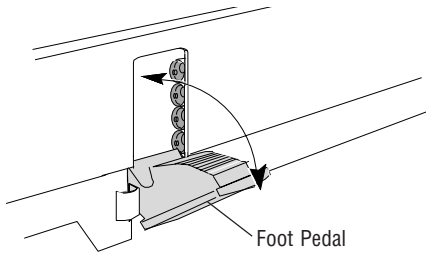

Figure 5-2. Foot Pedal

The toggle switches (or hand/foot control selections) are used in conjunction with the foot pedal for table movements when **no** electric pump power is available.

Articulate table as follows:

1. Flip foot pedal down (see Figure 5-2).
2. Position toggle switches, as outlined in *SECTION 5.1, ARTICULATION WITH ELECTRIC PUMP POWER AVAILABLE*, for desired movement (or select movement with hand or foot control).
3. Pump foot pedal manually (while still holding toggle switch [or hand or foot control button/pedal] in position) until desired degree of movement is obtained.
4. Stop pumping foot pedal and release toggle switch (or hand or foot control button/pedal) to stop movement and lock in position.
5. Correct problem or have qualified service technician repair table before further use.

5.3 Floor Lock Override Systems

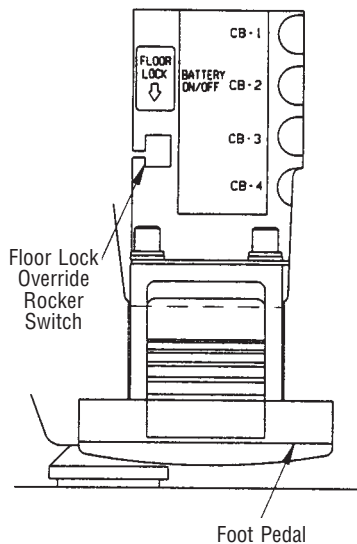

Figure 5-3. Floor Lock Override Switch

A floor lock override switch is located inside the manual pump pedal recess (see Figure 5-3). Flip the pedal down to access the switch (see Figure 5-2).

Operate the override system as follows:

- **If electric pump power is available:** move the rocker switch down to activate the UNLOCK function; release it when the floor locks are retracted and the table is resting on its casters. To activate the LOCK function, move the rocker switch up; release it when the table is resting on its floor locks (the casters swing freely).
- **If NO electric pump power is available:** move and hold the rocker switch down to activate the UNLOCK function and operate the foot pump (or have an assistant operate it) until the floor locks are retracted and the table is resting on its casters. To activate the LOCK function, move and hold the rocker switch up (or have an assistant operate it) until the table is resting on its floor locks (the casters swing freely).

6.1 Preventive Maintenance Schedule

⚠ WARNING – PERSONAL INJURY AND/OR EQUIPMENT DAMAGE HAZARD: Safe and reliable operation of this equipment requires regularly scheduled preventive maintenance, in addition to the faithful performance of routine maintenance. Contact STERIS to schedule preventive maintenance.

⚠ CAUTION – POSSIBLE EQUIPMENT DAMAGE: The use of incorrect hydraulic oil may severely damage the table and/or cause malfunction. Contact STERIS for the proper oil to use.

Maintenance procedures described in **SECTIONS 6 AND 8** should be performed regularly at the intervals indicated, using the maintenance schedules in **Table 6-1** as a guide. Increased usage of the table may result in more frequent maintenance than indicated. Refer to **SECTION 8** for replacement parts list.

Customer should maintain a record of all maintenance procedures performed on the unit.

If an operating problem occurs, refer to **SECTION 7, TROUBLESHOOTING**.

NOTE: Never permit unqualified persons to service the table.

IMPORTANT: If the table is to be placed in extended storage, have the table prepared for storage by a qualified service technician. Ensure the batteries are disconnected and check the batteries before reconnecting. The table must be operated through all articulations and the batteries must be charged every six months.

Table 6-1. Preventive Maintenance Schedule for Amsco® 3085 SP™ Surgical Table

SERVICE REQUIRED	MINIMUM FREQUENCY
1.0 PREPARATION FOR PREVENTIVE MAINTENANCE 1.1 Discuss equipment with operators. 1.2 Examine side rail hardware. Tighten as required. 1.3 Check X-ray tops for tightness of standoffs. 1.4 Check integrity of cap shroud.	6x per year 6x per year 6x per year 6x per year
2.0 HYDRAULIC SYSTEM 2.1 Replace oil filter element. 2.2 Check hydraulic oil level. 2.3 Check table base, all hoses, fittings, and components of hydraulic system for evidence of oil leaks.	1x per year 6x per year 6x per year
3.0 CASTERS AND FLOOR LOCKS 3.1 Check/clean casters. 3.2 Lubricate casters. 3.3 Check floor lock system; have qualified service technician adjust if needed. 3.4 Verify presence of all foot pads.	6x per year 1x per year 6x per year 6x per year

Table 6-1. Preventive Maintenance Schedule for Amsco 3085 SP Surgical Table (Cont'd)

SERVICE REQUIRED	MINIMUM FREQUENCY
4.0 CONTROLS 4.1 Verify proper operation of all articulations for full motion. <ul style="list-style-type: none"> • Using hand control. • Using override function. • Using manual control (foot pump). • Using foot control, if equipped. • Using battery power, if equipped. 4.2 Check integrity of hand control and cord.	6x per year 6x per year 6x per year 6x per year 6x per year 6x per year
5.0 ELECTRICAL CHECKS 5.1 Ensure all circuit board connectors and cable plugs are tight. 5.2 Check all cables for damage or fraying. 5.3 Verify battery charger voltage (28.5 Volts ± 1 percent, motor battery charger at P20; 28.3 Volts ± 1 percent, control battery charger at S1/S5 terminals). 5.4 Verify battery voltage (13.6-13.8 Volts per battery fully charged at 77°F [25°C]).	6x per year 6x per year 2x per year 2x per year
6.0 TABLE RIGIDITY 6.1 Check tabletop for any horizontal or vertical play. 6.2 Check side tilt mechanism for any play and ensure screws on the top clevis and bottom support bracket are secure. 6.3 Lubricate column guide rails.	2x per year 2x per year 1x per year
7.0 FINAL TEST 7.1 Secure all covers and shrouds. 7.2 Reinstall any pads that were removed. Check for rips, tears, etc. 7.3 Check area to ensure removal of all materials used during inspection.	6x per year 6x per year 6x per year

Table 6-2. Recommended Cleaning Products*

Product Name	Product Use
Coverage® Spray HB Ready-to-Use Disinfectant Cleaner	Hospital-grade quaternary-based disinfectant spray
Coverage® HB Concentrate	EPA-registered Hepatitis-B-effective quat
T.B.Q.® Hard Surface Disinfectant Cleaner	Detergent-based germicide
Coverage Plus® Concentrated Disinfectant Cleaner	One-step germicide disinfectant cleaner
Coverage® Spray Ready-to-Use Disinfectant Cleaner	General cleaner/disinfectant formulated with quaternary ammonium compounds and nonionic detergents
Germicidal Cloth Impregnated Non-Woven Disposable Cloth	Surface disinfectant

* Contact STERIS for ordering information.

6.2 Cleaning/Disinfecting Procedures

6.2.1 Post-Usage



WARNING – INFECTION HAZARD: To protect against aerosols being reflected from contaminated surfaces, wear rubber or plastic gloves, masks and eye protection and follow OSHA blood-borne pathogens standards when cleaning.



CAUTION – POSSIBLE EQUIPMENT DAMAGE:

- When cleaning/disinfecting table, do not use phenolics, which may cause patient skin burns if inadequately rinsed off, or alcohol, which does not have sufficient cleaning/disinfection properties.
- When cleaning/disinfecting table, thoroughly read the cleaning fluid directions for use and follow all directions and cautions as shown.
- Cleaning procedures requiring articulation of the table should be performed only by persons familiar with table operation.
- After performing cleaning procedures, ensure pads and X-ray tops are completely dry before reinstalling. Moisture trapped between pads and X-ray tops may contribute to equipment damage, such as X-ray top warpage.

1. Remove gross soil with a disposable cloth and place used cloth in an appropriate biohazardous waste disposal container.
2. Clean tabletop as follows:

- a. Articulate tabletop to level position and place at a comfortable working height.
- b. Remove tabletop pads by pulling upward to free them from hook fastener strips (see Figure 6-1) and place on another table or other flat surface.
- c. Holding can 6-8" (150-200 mm) from surface, spray cleaning fluid liberally on top and sides of pads. Clean only one pad at a time.

NOTE: Follow manufacturer's label recommendations when using cleaning fluids/disinfectants.

- d. Wipe sprayed surfaces with a clean lint-free cloth dampened with water to remove cleaning fluid. (Dampening cloth will minimize streaking.)
- e. Wipe cleaned surfaces again with a clean, damp, lint-free cloth to remove any remaining residue.
- f. Wipe cleaned surfaces again with a clean, dry, lint-free cloth to remove all moisture.
- g. Repeat **Steps c, d, e, and f** for bottom of pads.
- h. Holding can 6-8" (150-200 mm) from surface, spray cleaning fluid liberally on tabletop surfaces exposed when pads are removed.
- i. Repeat **Steps d, e, and f** for tabletop surfaces exposed when pads are removed.
- j. Place pads back onto tabletop by aligning with sides of table and pressing into place on hook fastener strips.

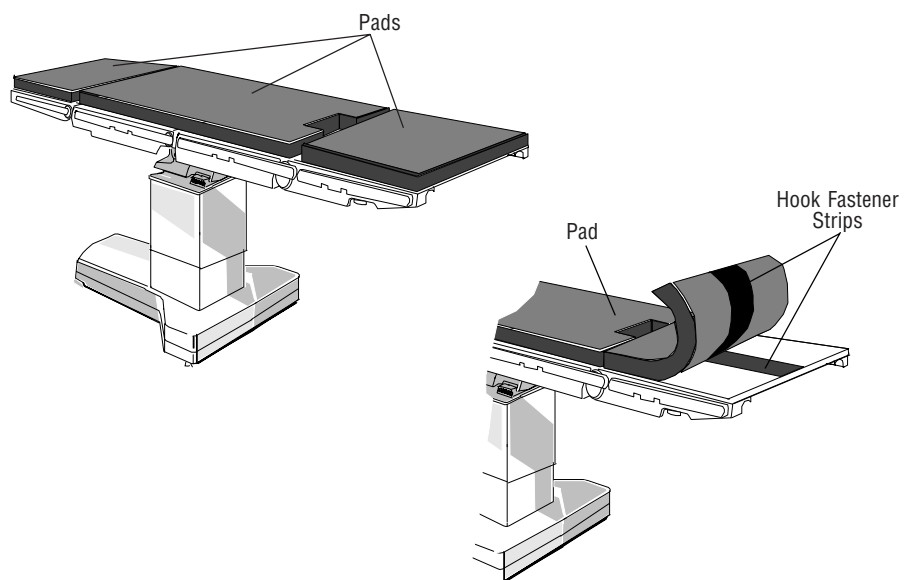

Figure 6-1. Remove Pads for Cleaning



CAUTION – POSSIBLE EQUIPMENT DAMAGE:

- **Cleaning procedures requiring articulation of the table should be performed only by persons familiar with table operation.**
- **Do not spray cleaning fluid into electric receptacles and avoid spraying directly on override switches or into clearance space above column. Spray or drippage may settle onto electric circuits inside table causing corrosion and loss of function.**



CAUTION – POSSIBLE EQUIPMENT DAMAGE: Hang the hand control from side rail (or end rail) of the table when not in use to avoid possible damage to the control.

3. Raise table to maximum elevation to access lower surfaces.
4. Clean column skirt, cap, and shrouds, and entire base surface as follows:
 - a. Holding can 6-8" (150-200 mm) from surface, spray cleaning fluid liberally on column skirt, cap, and shrouds.
 - b. Wipe sprayed surfaces with a clean cloth dampened with water to remove cleaning fluid. (Dampening cloth will minimize streaking.)
 - c. Wipe cleaned surfaces again with a clean, damp, lint-free cloth to remove any remaining residue.
 - d. Repeat **Steps a, b, and c** for base surface.
5. Turn control OFF when finished with cleaning tabletop and base.
6. Clean hand control as follows:
 - a. Disconnect hand control from table.
 - b. Holding can 6-8" (150-200 mm) from surface, spray cleaning fluid liberally on hand control and cord.
 - c. Wipe sprayed surface with a clean cloth dampened with water to remove cleaning fluid.
 - d. Wipe cleaned surfaces again with a clean, damp, lint-free cloth to remove any remaining residue.
 - e. Reconnect hand control to table, and store by attaching to table side rail.

6.2.2 End-of-Day

Perform all steps listed in *SECTION 6.2.1, POST-USAGE*, cleaning procedure.

6.2.3 Weekly



CAUTION – POSSIBLE EQUIPMENT DAMAGE:

- **Cleaning procedures requiring articulation of the table should be performed only by persons familiar with table operation.**
- **Do not spray cleaning fluid into electric receptacles and avoid spraying directly on override switches or into clearance space above column. Spray or drippage may settle onto electric circuits inside table causing corrosion and loss of function.**

1. Perform **Steps 1 through 4** under *SECTION 6.2.1, POST-USAGE*, cleaning procedure.
2. Articulate table through all movements and clean all additional exposed surfaces during these articulations as follows:
 - a. Holding can 6-8" (150-200 mm) from surface, spray cleaning fluid liberally on surface to be cleaned.
 - b. Wipe sprayed surfaces with a clean cloth dampened with water to remove cleaning fluid. (Dampening cloth will minimize streaking.)
 - c. Wipe cleaned surfaces again with a clean, damp, lint-free cloth to remove any remaining residue.
3. Turn control OFF when finished with cleaning procedures.

6.3 Biweekly Maintenance



WARNING – PERSONAL INJURY AND/OR EQUIPMENT DAMAGE HAZARD: Repairs and adjustments to this equipment must be made only by fully qualified service personnel. Nonroutine maintenance performed by inexperienced, unqualified personnel or installation of unauthorized parts could cause personal injury, invalidate the warranty, or result in costly damage. Contact STERIS regarding service options.

1. Charge batteries per instructions listed in *SECTION 6.5.1, BATTERY CHARGING PROCEDURE*.

NOTE: Battery-powered tables should have batteries charged a minimum of 38 hours every two weeks (more often if table usage demands).

2. Operate each table function. Operation should be smooth and quiet.

If it is not, call STERIS. A factory-trained service technician will promptly arrange to have the table placed in proper working order.

6.4 Monthly Maintenance

1. Clean casters and floor locks (see Figure 6-2).
2. Lightly lubricate caster bearings with Lubriplate No. 2 (R-6400-826)*, or equivalent.

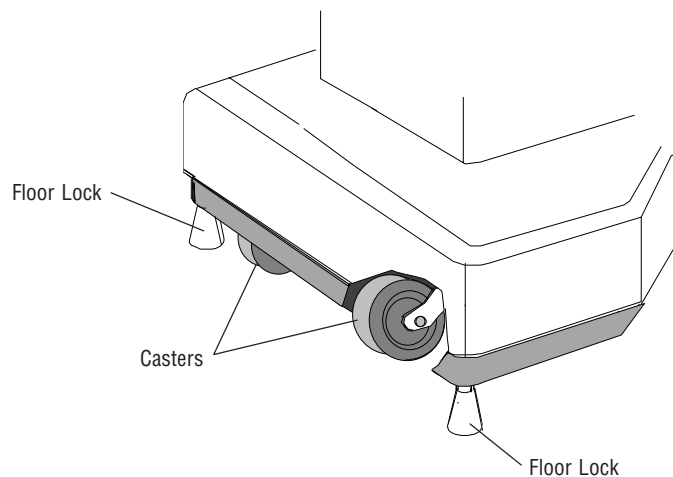

Figure 6-2. Casters and Floor Locks

* Available from STERIS.

6.5 Battery Charging Procedure

6.5.1 Electric-Powered Tables

Control batteries* are recharged automatically when table is being used and do not require additional charging.

6.5.2 Battery-Powered Tables

Motor and control batteries* will require recharging on a periodic basis depending on frequency of table usage. Low or discharged battery conditions are indicated by LEDs on the hand control as explained in the Hand Control Diagnostic Chart in *SECTION 7*.

WARNING – PERSONAL INJURY AND/OR EQUIPMENT DAMAGE HAZARD: Repairs and adjustments to this equipment must be made only by fully qualified service personnel. Nonroutine maintenance performed by inexperienced, unqualified personnel or installation of unauthorized parts could cause personal injury, invalidate the warranty, or result in costly damage. Contact STERIS regarding service options.

WARNING – TRIPPING HAZARD: Route the power cord to the receptacle in a position so it will not be tripped over by personnel in the area.

Lead acid batteries last longer if NOT fully discharged. Therefore, to obtain the longest life and capacity from your 3085 batteries, always connect AC power cord to table base and plug into an appropriate AC receptacle as often as possible, and as long as possible. If this is not always possible, recharge batteries at the following times:

- When table is first put into service.
- Every two weeks when table is in normal service; more often if usage demands.
- Whenever a low battery indicator LED is ON.
- If table remains in extended storage, batteries must be charged every six months.
- It is **not necessary** to have **hand control** ON to charge batteries.
- On either electric-powered or battery-powered 3085 SP, power cord may be left plugged into appropriate receptacle indefinitely. It will not harm table nor table batteries.

NOTE: If batteries will not charge, refer to SECTION 7 for possible causes and corrective actions.

Recharge batteries as follows:

1. Connect AC power cord to table base and plug into an appropriate AC receptacle (see Figure 6-3).

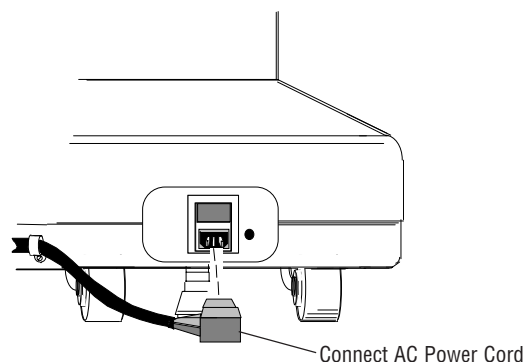

Figure 6-3. Charge Batteries

* All motor and control batteries are a sealed, lead-acid gel electrolyte-type, with a nominal life of four years.

2. Allow a **minimum of 48 hours** for full battery charge. See chart below:

Charging Time	Portion Charge
24 hours	90 percent
36 hours	95 percent
48 hours	100 percent

3. Verify low battery indicator LED is off and disconnect AC power.

4. As an alternative to **Step 2**, battery table may be used during daytime on battery and charged at night for six to eight hours charging time minimum.

OR

Table may be used during week and charged over weekend (38 hours).

5. Depending on how batteries are cared for, table battery life can vary greatly. The following can shorten the battery's useful life:

- continuing to leave this type of battery discharged for a long period, or
- continuing to use table battery even though battery light is blinking and not plugging table into appropriate receptacle, or
- not fully charging battery.

⚠ WARNING – PERSONAL INJURY AND/OR EQUIPMENT DAMAGE HAZARD: Safe and reliable operation of this equipment requires regularly scheduled preventive maintenance, in addition to the faithful performance of routine maintenance. Contact STERIS to schedule preventive maintenance.

This section describes the types of Amsco® 3085 SP™ Surgical Table malfunctions most likely to occur, and probable causes and corrective actions. Use the Operator Troubleshooting Chart to identify general problems. Use the Hand Control Diagnostics Chart to identify problems as indicated by the hand control LEDs.

If you are unable to correct the problem with the use of the Operator Troubleshooting Chart or the Hand Control Diagnostics Chart, or if a problem occurs not described on the charts, please contact STERIS. A trained service technician will promptly place your equipment in proper working order.

NOTE: Never permit unqualified persons to service the table.

Operator Troubleshooting Chart

PROBLEM	POSSIBLE CAUSE AND CORRECTIVE ACTION
1. Cannot turn table ON.	<ol style="list-style-type: none"> 1. Hand control not connected – Connect per SECTION 3. 2. Hand control defective – Replace.
2. No power to pump motor; table will not articulate.	<ol style="list-style-type: none"> 1. Table unplugged (electric-powered table only) – Plug in. 2. No facility power (electric-powered table only) – Turn facility power on. 3. F1 or F2 fuse blown (electric-powered table only) – Replace fuse(s) per SECTION 8. 4. AC power cord defective (electric-powered table only) – Replace power cord. 5. Batteries totally discharged (battery-powered table only) – Recharge batteries per SECTION 6. 6. Circuit breaker CB-1 tripped (electric-powered table only) – Reset per SECTION 8. 7. Circuit breaker CB-2 tripped (battery-powered table only) – Reset per SECTION 8.
3. Motor batteries will not charge (battery-powered table only).	<ol style="list-style-type: none"> 1. Circuit breaker CB-4 tripped – Reset per SECTION 8. 2. Circuit breaker CB-2 tripped – Reset per SECTION 8. 3. AC power cord defective – Replace power cord.

Hand Control Diagnostics Chart

NOTE: When power supplies are operational and the table is plugged into an AC receptacle, the ON touch pad green LED and AC power green LED will be ON.

INDICATION	CONDITION	CORRECTIVE ACTION
1. Control ON – green AC LED is ON and red BATTERY LED is flashing.	AC power connected; low or discharged batteries (battery-powered table only).	Charge batteries per <i>SECTION 6</i> .
2. Control ON – green BATTERY LED is ON and red BATTERY LED flashing.	Low or discharged batteries (battery-powered table only).	Charge batteries per <i>SECTION 6</i> . <i>NOTE: If batteries are totally discharged, control shutdown will occur after 3-1/2 minutes when table is in use or after 30 seconds if condition exists at power up.</i>
3. Control ON – green BATTERY LED (only) is ON when table plugged into AC receptacle.	Battery level acceptable; faulty battery charger or power circuit (battery-powered table only).	<ol style="list-style-type: none"> 1. Check AC power cord – Replace power cord if necessary. 2. Check F1 and F2 fuses – Replace fuse(s) if necessary. 3. Reset circuit breaker CB-3. 4. Reset circuit breaker CB-4. 5. Reset circuit breaker CB-1.
4. All green, yellow, and red LEDs flashing.	No communication between table control and hand control.	<ol style="list-style-type: none"> 1. Check hand control connection per <i>SECTION 3</i>. 2. Replace hand control if necessary.
5. Green ON LED flashing.	1. Optional foot control switch was actuated when hand control switched ON; control logic error disables foot control functions.	Turn hand control OFF, then ON to reset controls.
	2. Faulty foot control; foot control function is disabled.	Replace foot control.

Hand Control Diagnostics Chart (Cont'd)

INDICATION	CONDITION	CORRECTIVE ACTION
6. All LEDs are OFF (not lit).	1. Hand control unplugged while table control ON; control automatically shuts off after two minutes.	Reconnect hand control per <i>SECTION 3</i> .
	2. AC power off (electric-powered table only); control automatically shuts off six hours after last function selected.	Reconnect AC power cord per <i>SECTION 3</i> .
	3. Floor locks off (battery-powered table only); control automatically shuts off 30 minutes after last function selected.	Activate floor locks per <i>SECTION 3</i> .
	4. AC power off (battery-powered table only); control automatically shuts off 24 hours after last function selected.	Reconnect AC power cord per <i>SECTION 3</i> .
7. Hand Control will not physically plug into the table.	Hand control plug will not slide into receptacle.	1. Check the control: The standard hand control has a 6-pin connector and will not fit either the HERMES®-Ready ¹ or ACT Enabled™ 3085 SP Table.
		2. Check the control: The HERMES®-Ready ¹ and ACT Enabled™ hand controls have an 18-pin connector and will not fit the standard 3085 SP Table.
		3. If plug or receptacle is deformed, it must be replaced.

NOTE: For troubleshooting of the optional HERMES®-Ready¹ system, refer to the HERMES® Operating Room Control Center Operating and Maintenance Manual, provided with the Operating Room Control System (ORCS). For troubleshooting of the optional ACT Enabled™ system, refer to the ACT Enabled™ Operating Manual, provided with the Operating Room Control System (ORCS).

¹HERMES-Ready is a registered trademark of Computer Motion.

WARNING – PERSONAL INJURY AND/OR EQUIPMENT DAMAGE HAZARD: Repairs and adjustments to this equipment must be made only by fully qualified service personnel. Nonroutine maintenance performed by inexperienced, unqualified personnel or installation of unauthorized parts could cause personal injury, invalidate the warranty, or result in costly damage. Contact STERIS regarding service options.

The material in this section is provided to allow for servicing components of the Amsco® 3085 SP™ Surgical Table most likely to need attention. These procedures are more advanced than cleaning and replacing expendables. These procedures should always be performed by an experienced, trained service technician.

8.1 Reset Circuit Breakers

Four circuit breakers (CB-1, CB-2, CB-3, and CB-4) protect various table components* and may be reset if tripped by a fault condition. When tripped, the circuit breaker will pop out and is readily detectable.

Reset circuit breakers as follows:

1. Lower foot pedal on table base to access circuit breakers (located on right of opening when foot pedal is down). See Figure 8-1.
2. Press in on protective boot covering circuit breaker to reset.
3. Raise foot pedal back into stored position.

* *CB-1 protects power transformer.
CB-2 protects motor batteries and has extra internal manual on/off switch.
CB-3 protects motor battery charger.
CB-4 protects control power supply.*

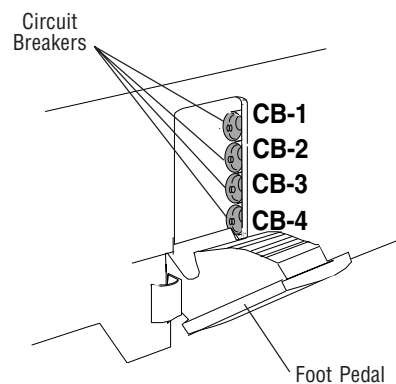

Figure 8-1. Circuit Breakers

8.2 Change Fuses

Two replaceable fuses (F1 and F2) are located in a cartridge above the AC input in the table base. If one or both of the fuses are blown by a fault condition, replace as follows:

1. Disconnect AC power cord from wall receptacle and table base input (see Figure 8-2).
2. Pry cartridge out with a small screwdriver to access fuses.
3. Remove blown fuse(s) and replace. Refer to **Table 8-1** for correct rating and part number of fuses.
4. Push cartridge back into connected position and reconnect AC power cord to table. Plug cord into wall receptacle.

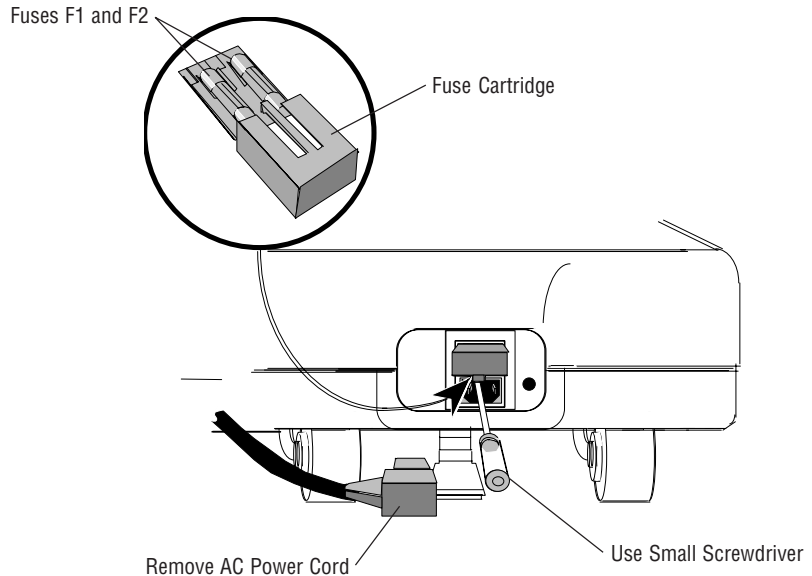

Figure 8-2. Fuse Location

Two replaceable fuses (F3 and F4) are located internal to the table. These require removal of the base shroud for access. Replacement of these fuses must be made only by a fully qualified service technician. Refer to **Table 8-1** for correct rating and part number of fuses.

8.3 Disconnect the Motor Battery

CB-2 circuit breaker, in addition to being a protective device, includes an internal, manually operated ON/OFF switch. If necessary, the motor battery can be disconnected from the table circuit as follows:

1. Press in on protective boot covering CB-2 circuit breaker until a “click” is felt.
2. Release button.
3. In OFF position, button is popped out same as when circuit breaker is tripped. To reset, see **SECTION 8.1, RESET CIRCUIT BREAKERS**.

8.4 Replacement Parts

The parts listed in **Table 8-1** may be necessary to do minor maintenance on the Amsco 3085 SP Table.

To order replacement parts, proceed as follows:

1. Include part number and description listed in **Table 8-1**.
2. Include model and serial numbers of your equipment on your order.
3. Send your order directly to STERIS.

Contact STERIS if you need any parts not listed in **Table 8-1**.

NOTE: Use only STERIS authorized parts on the equipment. Use of unauthorized parts will void the warranty.

Table 8-1. Amsco 3085 SP Surgical Table Replacement Parts

Description	Part Number	Recommended Spares
Power Cord Types Available <ul style="list-style-type: none"> • USA Plug, USA Cord • USA Plug, IEC Cord • Schuko Plug, IEC Cord • Australian Plug, Orange Cord • English Plug, IEC Cord 	P93909-354 P56397-682 P56397-687 P56397-686 (see NOTE 2) P56397-684	One spare of the type you use. If your plug is not in this list, order the Power Cord type nearest to your applications, cut the plug off and install your plug in its place. Always use a grounded plug.
Hand Controls <ul style="list-style-type: none"> • Standard 3085 SP • HERMES®-Ready¹ 3085 SP • ACT Enabled™ 3085 SP 	P141210-318 P141210-367 P146664-103	¹ HERMES-Ready is a registered trademark of Computer Motion.
Fuse Applications <ul style="list-style-type: none"> • 120 VAC Application F1 and F2 F3 F4 (if used) • 120 VAC Application (Export): F1 and F2 F3 F4 (if used) • 100 VAC Application F1 and F2 F3 F4 (if used) • 220 VAC Application F1 and F2 F3 F4 (if used) • 230/240 VAC Application F1 and F2 F3 F4 (if used) 	See NOTES 3, 4, and 5 P93909-225 (6 Amp, USA) P93909-222 (0.5 Amp, USA) P89371-091 (1 Amp, USA) P150823-292 (6 Amp, IEC) P129360-586 (0.5 Amp, IEC) P150823-248 (1 Amp, IEC) P150823-292 (6 Amp, IEC) P129360-586 (0.5 Amp, IEC) P150830-131 (1.6 Amp, IEC) P129360-587 (4 Amp, IEC) P129360-585 (0.25 Amp, IEC) P129360-586 (0.5 Amp, IEC) P129360-587 (4 Amp, IEC) P129360-585 (0.25 Amp, IEC) P129360-586 (0.5 Amp, IEC)	10 5 5 10 5 5 10 5 5 10 5 5
Batteries	See NOTE 1	See NOTE 1

NOTES:

1. This table uses lead-acid batteries. Lead-acid batteries normally are subject to self-discharge and battery-life deterioration in long-term storage. Therefore, STERIS does not recommend batteries be procured and then stored as spare parts. If batteries are procured and stored, they should be kept covered and in a cool, dry area. Stored batteries should be recharged every six months to minimize life deterioration. Use a charging current commensurate with the battery amp-hour size. Charge to a floating charge voltage equivalent to 13.6-13.8 volts.
2. The cords are approximately 6 m (20 ft) long, except for the Australian cord which is only 4 m (13 ft) long.
3. USA fuses are AGC or ABC or MTH, and are also for use in Canada.
4. IEC fuses are IEC glass fuses. IEC fuses for F3 and F4 require IEC fuseholder, STERIS part number P129360-654.
5. Motor battery chargers built after September 2001, may be auto-ranging and have no F4 fuse.

 **WARNING – DISPOSAL HAZARD:** This product contains materials which may require disposal through appropriately licensed and permitted hazardous waste management firms.

 **CAUTION – POSSIBLE EQUIPMENT DAMAGE:** Use of incorrect hydraulic oil may severely damage the table and/or cause malfunction. Contact STERIS for proper hydraulic oil.

The following materials are contained within the Amsco® 3085 SP™ Surgical Table. When disposing of the table or its parts, ensure the proper disposal of hazardous and other regulated waste in compliance with federal, state, and local regulations.

- **Lead (Pb) Weight** – solid weight (P146653-460, quantity = 1) located in the table base at the narrow end. Approximate weight = 90 lbs (41 kg).
- **Lead Acid (Pb/H₂SO₄)** – gelled cell batteries (P93908-637, quantity = 2 and P136806-806, quantity = 2 battery-powered table only) located in the table base in the narrow end. Approximate weight = 39 lbs (14 kg).
- **Mercury (Hg)** – in sealed glass tube electrical switches, contained in RTV potted Return-to-Level switch assemblies (P136807-726, P136807-727, and P136807-728). Quantity = 3 assemblies per table (two mercury switches per assembly). Two assemblies are located in the back section frame and one assembly is located in the seat section frame. Approximate total mercury per table = 18 g.
- **Hydraulic Oil** – Chevron AW32 or equivalent (P150823-197; service part P764322-636). Oil is in the hydraulic components located in the base, on the column, in the seat section, in the back section, inside the column, and in all the hydraulic system lines and hoses. Approximate quantity = 0.9 US gal (3.4 L).
- **Gear Compound** – Chevron grade 680, located in the oiler pads in the column. Approximate amount = 1 oz (28 g).
- **Lead (Pb) in Solder** – contained in solder on circuit boards and in some miscellaneous wire connections. Minute amounts.
- **Electronic and Electrical Parts** – not known to require special disposal methods at date of this manual.
- **Metal Parts** – made from aluminum (Al), steel (Fe), cast iron (Fe), copper (Cu), and copper alloys (Cu/x), plastic, synthetic rubber, plating (Cr, Ni, Zn, Au), and adhesives not known to require special disposal methods at date of this manual.