

# NOUVELLE

## USER GUIDE

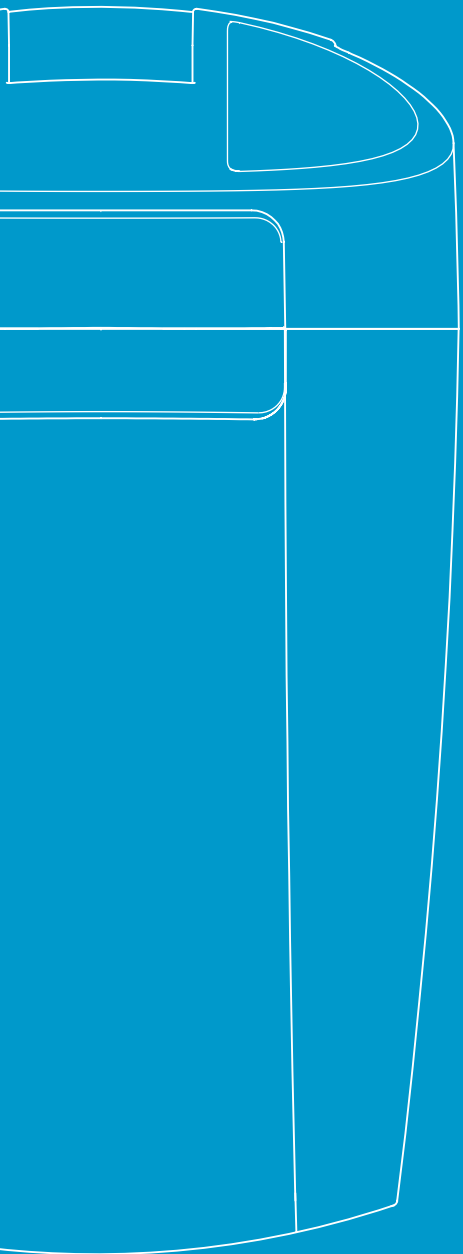



# Index

About the Aqualuxe	2
Aqualuxe Features	2
Before You Begin	3
Aqualuxe Drinking Water System	4
Inspect Your Drinking Water System	6
• Aqualuxe Exterior	6
• Aqualuxe Interior	7
Connect Your System To WiFi	8
• Connect Your WiFi Device To The Aqualuxe	8
• Connect the Aqualuxe To Your WiFi Network	8
Install Your System	9
Prepare Your System For Use	9
Maintenance	10
• Regarding Filter Capacity	10
• Removing The Old Filter	10
• Installing The New Filter	11
Flushing / Disinfecting The System	12
Aqualuxe Status Panel	12
Multipure FilterSync Technology	14
Warranty	15
Contaminat Reduction Performance	16
• Product Certifications	16
• Arsenic Facts	16
• Volatile Organic Chemicals List	18
Troubleshooting	19
Frequently Asked Questions	21
Aqualuxe Acessories	23

# Aqualuxe User Guide

## About The Aqualuxe Drinking Water System

- Multipure's Aqualuxe Drinking Water System (AQUALUXE) is certified to be plumbed into separate tap.
- The Aqualuxe is third-party tested and verified for NSF Standard 42 (Aesthetic Contaminants), NSF Standard 53 (Health Contaminants), NSF Standard 401 (Emerging Contaminants), and NSF Protocol P231 (Microbiological Purifier).
- The Aqualuxe can be installed for use on the counter or below the sink.
- If installation or operation assistance is required, please contact your Multipure Independent Builder. If the Independent Builder is unavailable, please contact Multipure Customer Service at 1.800.622.9206.

## Aqualuxe Features

Multipure's Aqualuxe Drinking Water System offers several innovative features designed to enhance the system's capabilities and improve the user experience. These features include:

- Quick-change filter cartridge
- Self-sealing pressure vessel
- PureBlock bacteria and virus removal
- FilterSync filter recognition technology
- WiFlow WiFi filter status monitoring
- QuickSecure accessory connector
- Leak detector
- Low battery indicator (batteries included)

# Before You Begin

Installation, operation, and maintenance requirements are essential to the performance of your system – failure to follow any instructions or operating parameters contained herein may lead to product damage or product failure.

- Replacement filters can be purchased directly from Multipure. For the latest prices, please visit our website at [www.multipure.com/store/](http://www.multipure.com/store/).
- Actual filter life depends on the amount of water used and the level of impurities in the water. See section **Regarding Filter Capacity (Pg 10)** for additional details.
- This system is not intended to convert wastewater or raw sewage into drinking water.
- Do not allow water to freeze in the system. If the system is exposed to freezing temperatures, drain water from the system and remove the filter. Allow the filter to thaw before replacing and reusing.
- Do not allow water to sit in the system for extended periods of time (e.g., 10 days or more) without use. See section **Flushing / Disinfecting the System (Pg 12)** for additional details.
- To dispose of the used filter, remove it from the housing and place in the trash. Filters disposed in a normal landfill will not release any chemical contaminants and may continue to adsorb additional contaminants in the landfill.



15.19 (a) This device complies with part 15 of the FCC Rules. Operation is subject to the condition that this device does not cause harmful interference.

Patent 9,783,430; 9,815,725; 9,922,474; 10,607,046

[www.multipure.com/patents](http://www.multipure.com/patents)

# Aqualuxe Drinking Water System

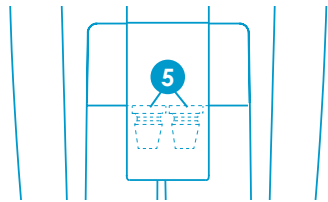
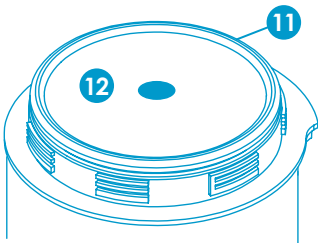
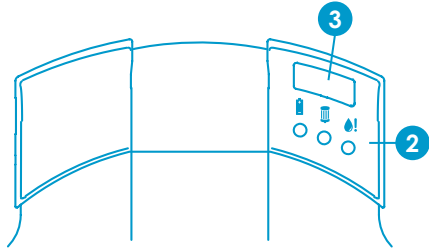
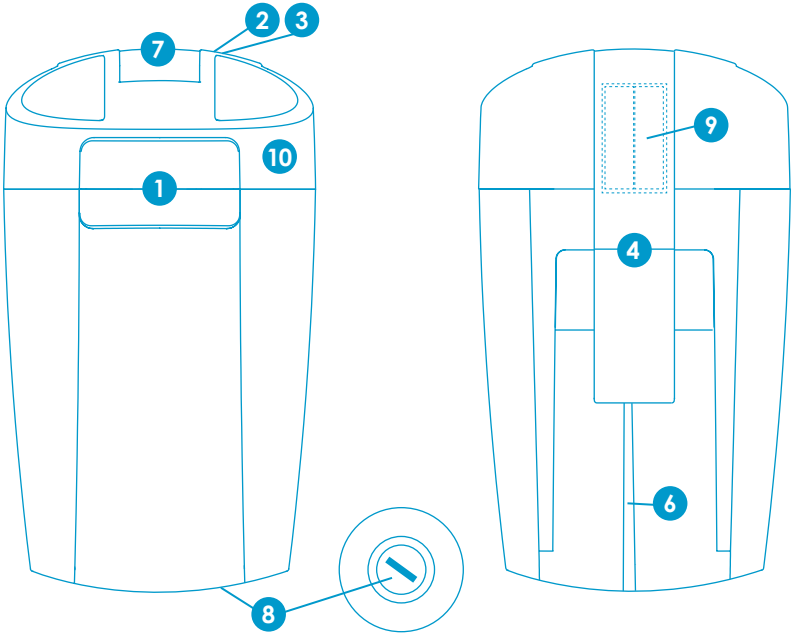

## Aqualuxe Exterior

1. Front handle
2. Status panel
3. Multifunction button
4. Rear locking panel
5. Connection port
6. QuickSecure channel
7. Top locking panel
8. Leak detector (bottom of system)

## Aqualuxe Interior

9. Battery compartment (behind rear locking panel)
10. Removable housing top
11. Pressure vessel
12. Filter

# Specifications

<b>Model Name:</b>	AQUALUXE
<b>Filter Capacity:</b>	500 Gallons
<b>Replacement Filter Type:</b>	CBLX
<b>Flow Rate:</b>	0.75 gpm
<b>Pressure Vessel Composition:</b>	Stainless Steel
<b>Housing Dimensions:</b>	13" h x 8" w
<b>Outlet:</b>	1/4" Pipe
<b>Inlet:</b>	3/8" Pipe
<b>Working Pressure Range:</b>	30 psi (2.1 kg/cm <sup>2</sup> ) to 100 psi (7.0 kg/cm <sup>2</sup> )
<b>Operating Temperature Range:</b>	32° F (0° C) to 100° F (38° C) - for cold water use only
<b>Particle Retention Size:</b>	0.5 micron (sub-micron)
<b>Certified By:</b>	NSF International

# Inspect Your Drinking Water System

Before setting up and connecting your Aqualuxe Drinking Water System, inspect your DWS to confirm that it has been received in good condition and that all parts are included.

## Aqualuxe Exterior

1. **Front Handle:** The silver handle at the front of the system displays the Multipure logo. When lifting the Aqualuxe, grip the system with one hand using the front handle and the other hand steadying the system from the side, back, or bottom.
2. **Status Panel:** The status panel is located on the upper right of the housing top. LED lights indicate filter status, battery status, and leak status.
3. **Multifunction Button:** Located above the status panel, this button serves multiple functions. Please refer to page 12 (Aqualuxe Status Panel) for details.
4. **Rear Locking Panel:** Located at the back of the system, the rear locking panel wraps over the top rear of the system, holding the housing top in place. The rear locking panel must be closed securely for the system to function properly. NOTE: DO NOT use the open rear locking panel as a grip or handle for moving the Aqualuxe, as this can cause severe damage to the system housing.
5. **Connection Port:** Located below and slightly behind the rear locking panel, the Aqualuxe connection port is where the QuickSecure adapter and tubing connects the Aqualuxe to either a dual-hose diverter valve or below-sink kit.
6. **QuickSecure Channel:** Located at the back of the system, below the rear locking panel, the QuickSecure channel is a small indentation that runs the length of the back housing up to the Aqualuxe connection port. It is used to properly guide the QuickSecure adapter and tubing into the Aqualuxe connection port.
7. **Top Locking Panel:** In conjunction with the rear locking panel, the top locking panel holds the housing top in place. NOTE: DO NOT pull, twist, or otherwise use the open top locking panel as a handle, as this can cause severe damage to the system housing.



- 8. Leak Detector:** A small metal sensor located on the bottom of the system housing that can detect if the system is in standing water.

## Aqualuxe Interior

Familiarize yourself with the interior of your Aqualuxe DWS.

- 1.** Grip the rear locking panel from the top rear of the system and pull it backwards away from the system to open and reveal the battery compartment. Do not force the rear locking panel to open further than a 90 -100 degree angle, as this can damage the panel.
- 2. Battery Compartment:** Located behind the rear locking panel, the battery compartment holds two (2) AA batteries, used to power the system electronics. In shipping, a plastic tab prevents the batteries from making contact with the system and powering on. Remove the plastic tab to power on the system. The system will beep once and the status panel may flash to indicate power on and a systems check.
- 3. Removable Housing Top:** The housing top incorporates a proprietary self-sealing mechanism to prevent leaks and to ensure that the filter is secure inside the system. It also utilizes Multipure FilterSync technology to ensure the proper installation and monitoring of the Multipure solid carbon block filter.
- 4.** Lift the top locking panel to unlock the housing top. Do not force the top locking panel to open further than a 90 - 100 degree angle, as this can damage the panel.
- 5.** Rotate the housing top counter-clockwise 35 - 45 degrees to open. Lift the housing top and set it to the side to reveal the pressure vessel and filter inside the system.
- 6. Pressure Vessel:** The stainless steel pressure vessel holds the carbon block filter and processes water for treatment.
- 7. Filter:** The genuine Multipure carbon block filter comes pre-installed inside the Aqualuxe pressure vessel. The Aqualuxe filter utilizes Multipure FilterSync technology to ensure proper installation and operation.

Determine your installation location (e.g., countertop, below sink, inline) and make sure your installation kit (if needed) is open and available. Multipure recommends the use of a professional plumber for system installation.

# Connect Your System To WiFi

Use the following steps to connect your system to your WiFi signal. This will allow your Aqualuxe to properly monitor your filter status and water usage.

## Connect Your WiFi Device to the Aqualuxe

Use the following steps to connect your WiFi-enabled device (computer, tablet, or smartphone) to the Aqualuxe.

1. On the top of the Aqualuxe, press and hold the multifunction button for 10 seconds to begin WiFi Setup Mode. The battery light on the status panel will blink orange. NOTE: The Aqualuxe will stay in WiFi Setup Mode for 2 minutes; if no device connects to the Aqualuxe within that time, it will exit this mode and the battery light will no longer blink orange.
2. On your WiFi-enabled device, open your WiFi settings and search for a new WiFi connection. The Aqualuxe will display in the WiFi network list as "Multipure\_AP" (Multipure Access Point).
3. Instruct your WiFi device to connect to Multipure\_AP. The Aqualuxe battery light will blink green upon successful connection.

## Connect the Aqualuxe to Your WiFi Network

Use the following instructions to direct the Aqualuxe to search for your WiFi router or access point.

1. On your WiFi-enabled device, open a web browser (e.g., Google Chrome, Firefox, Microsoft Edge, Safari, etc.) and direct the browser to the following address: <http://192.168.1.3>
2. The Aqualuxe Setup Page will appear on your web browser. Click "Registration" on the left side of the page.
3. "Register your Multipure product" will display. Complete the required fields to register your system with the network:
  - a. first name
  - b. last name
  - c. email address
4. Click "Register Information." "Locate your WiFi Network" will display. Click "Scan for Wireless Networks".

5. A list of wireless networks will display. Click on the name of the WiFi network with which you would prefer the Aqualuxe to connect. If necessary, enter the WiFi password to access the network, and then click "OK".
6. "Reconnection in Progress" will display. On the Aqualuxe status panel, the filter light and battery light will alternate blinking orange and blinking green until a connection is finalized.
7. When the Aqualuxe is finished with the WiFi setup, the filter light and battery light will alternate blinking green. After a few seconds, the lights will turn off. The Aqualuxe is now connected to your WiFi network.
8. Congratulations on successfully connecting your Aqualuxe to WiFi!

## Install Your System

The Aqualuxe is certified to be plumbed into separate tap. The Aqualuxe can be installed below the sink or on top of the countertop next to the sink. Please refer to the Installation Guide included with your Accessory Kit for step-by-step instructions.

The Aqualuxe can be used inline for refrigerators, water coolers, or ice makers, so that all of the water from the cold water outlet or faucet is filtered. NOTE: Although many parts of the installation kit will not be used with an inline connection, the QuickSecure adapter is still necessary to connect to the Aqualuxe.

## Prepare Your System For Use

1. Using a paper towel or cloth, dry off all connections and the system housing.
2. Make sure that all connections are tightly secured.
3. Flush the system before use.
  - a. Allow water to flow through the Aqualuxe and the faucet for 15 minutes. This purges any air and loose carbon from the system.
  - b. Adjust the water supply so that the water flow to the drinking water faucet does not exceed the flow rate of 0.75 gallons per minute.

NOTE: It takes approximately 20 seconds to fill a quart at a flow rate of 0.75 gallons per minute.

4. Check all connections to make sure that there are no leaks.
5. Congratulations! Your system is now ready for use!

## Maintenance

### Regarding Filter Capacity

1. Exact filter capacity varies in proportion to the amount of water used and the level of impurities in the water being processed. For contaminants reduced through physiochemical adsorption, the filter capacity is 500 gallons. For contaminants reduced through mechanical filtration, capacity claims are inapplicable due to broad variations in the quality and quantity of physical matter in the drinking water. Excessive physical matter will cause the DWS to clog, diminishing flow rate but still reducing the contaminants from the water stream.
2. For optimum performance and to maintain the lifetime warranty on your system housing, it is essential that the filter be replaced when the first of the following occurs:
  - a. Annually
  - b. When the system indicates it is near or has reached its rated capacity
  - c. When the flow rate diminishes
  - d. When the filter becomes saturated with bad tastes and/or odors

### Removing The Old Filter

1. Stop the water supply and relieve the water pressure in the Aqualuxe. NOTE: Relieve pressure by letting water run through faucet until it trickles.
2. On the back of the Aqualuxe, press the release button on the QuickSecure adapter and pull down to disconnect the tubing from the system housing. Expect some water to briefly flow from the Aqualuxe connection port.
3. Grip the rear locking panel from the top rear of the system and pull it backwards away from the system to open and reveal the battery

compartment. Do not force the rear locking panel to open further than a 90 - 100 degree angle, as this can damage the panel.

4. Lift the top locking panel to unlock the housing top. Do not force the top locking panel to open further than a 90 - 100 degree angle, as this can damage the panel.
5. Rotate the housing top counter-clockwise 35 - 45 degrees to open. Lift the housing top and set it to the side to reveal the pressure vessel and filter inside the system.
6. Lift the handle on the top of the Aqualuxe filter and pull to remove the old filter.
7. Dispose the used filter in your waste container.
8. Rinse out the inside of the system housing, hand washing if necessary.

## Installing The New Filter

1. If you have not done so already, remove the plastic wrapper and instruction wrap from around the new filter.
2. Align the nipple of the new filter cartridge into the hole at the bottom of the pressure vessel. Once aligned, push the new filter cartridge until it stops.
3. Place the housing top on top of the system housing and rotate it clockwise until it is properly aligned. NOTE: The housing top and system housing are threaded so that they will only fit together tightly in one position.
4. Close the top locking panel until it is even with the system housing.
5. Change the batteries in the system.
  - a. Remove the batteries from the battery compartment (located behind the rear locking panel).
  - b. Place two (2) Lithium AA batteries in the battery compartment.
  - c. Close the rear locking panel until it securely fastens atop the top locking panel.
  - d. Reconnect the QuickSecure adapter and prepare your system for use. Please refer to page 12 (Aqualuxe Status Panel) for guidance on the status panel lights.

NOTE: Please refer to page 14 (Multipure FilterSync Technology) to learn more about the importance of always using genuine Multipure replacement filters.

# Flushing / Disinfecting The System

Multipure recommends that you not allow water to sit in the system for extended periods of time without use. If a system is left unused for more than 10 days, it may need to be flushed / disinfected before resuming normal use.

1. Remove the filter by following the directions in page 10 (Removing the Old Filter).
2. Add 5 to 7 drops of bleach to the pressure vessel.
3. Replace the housing top without a replacement filter installed. Close the top locking panel and rear locking panel, and reconnect the QuickSecure adapter and tubing.
4. Turn on the water supply and allow the system to fill up with the water/bleach solution.
5. Let the water and bleach flush out of the system.
6. Open, clean, and rinse out the inside of the pressure vessel.
7. Follow the directions in page 11 (Installing the New Filter).

## Aqualuxe Status Panel

The Aqualuxe status panel is located on the upper right of the housing top. LED lights indicate filter status, battery status, and leak status. NOTE: The rear locking panel and top locking must be closed for the status panel function properly.

The status panel may light up and beep during the following conditions:

1. Water is flowing through the system.
2. The multifunction button is pressed.
3. The system detects standing water.
4. Batteries are installed or replaced.



The individual LED lights will display in one of three colors: green, orange, or red. Use the following chart to read and understand the status panel:

System Status or Action	LED Lights			Sound	Condition
	Battery	Filter	Leak		
Water Flowing System In Use	—	—	●	None	Water flowing. No leak detected.
	—	●	—	2 Beeps	Filter < 50 gal. Change filter soon.
	—	●	—	3 Beeps	Filter capacity full. Change filter now.
	●	—	—	1 Beep	< 10% battery Change battery now.
Short button press	—	●	—	None	Filter is good.
	—	●	—	None	Filter < 50 gal Change filter soon.
	—	●	—	None	Filter capacity full. Change filter now.
	●	—	—	None	Battery is good.
	●	—	—	None	Change battery soon.
	●	—	—	None	< 10% battery Change battery now.
	—	—	●	None	No leak detected.
	—	—	●	None	Leak detected.
Press/hold button for 10 seconds	● (blinking)	—	—	None	Aqualuxe waiting for WiFi-enabled product to connect to it.
	● (blinking)	—	—	None	WiFi-enabled product connected to Aqualuxe.
Connecting Aqualuxe to WiFi network (through Aqualuxe setup page)	● (blinking)	● (blinking)	—	None	Aqualuxe attempting to connect to WiFi network.
	● (blinking)	● (blinking)	—	None	Connected to WiFi network. Attempting to send data to Multipure
	● (blinking)	● (blinking)	—	None	Connected to WiFi network. Connected to Internet. Successfully sent data to Multipure
	● (blinking)	● (blinking)	—	None	Failed to connect to WiFi network.
	● (blinking)	● (blinking)	—	None	Failed to connect to Internet. Failed to send data to Multipure.
Leak detected (no button press)	—	—	●	1 Beep	Leak detected.
New or replacement batteries connected	●	●	●	1 Beep	Power up status check.
Any time	●	●	●		Software error. Remove and replace batteries.

# Multipure FilterSync Technology

The Aqualuxe utilizes Multipure's innovative FilterSync technology to ensure that your genuine Multipure carbon block filter is working at optimal performance. Through FilterSync technology, the Aqualuxe can communicate directly with your filter to track its performance, accurately gauge filter capacity, and monitor water usage.

**CAUTION: DO NOT** use a non-Multipure replacement filter with your Aqualuxe. If a replacement filter without FilterSync technology is installed in the Aqualuxe, the Aqualuxe will detect it as a filter at full capacity that needs to be changed. Using a non-Multipure replacement filter may invalidate the warranty on your system.





# Warranty

**Multipure 90-Day Guarantee:** Multipure is confident in the performance of its water treatment system. If you should find your Multipure Aqualuxe unsatisfactory, let us know within 90 days of purchase for a prompt exchange or refund.

**Multipure Warranty:** Multipure warrants to the original retail customer its water treatment system and components to be free of defects in material and workmanship for use under normal care, and will repair or replace any system at no charge (excluding transportation to Multipure Corporate Headquarters) to the customer during the warranty period. The system housing is warranted for a lifetime (provided the filter has been changed at least once per year); all accessories provided by Multipure are also warranted for defects in material and workmanship for one (1) year.

Multipure Solid Carbon Block Filters are warranted for defects in material and workmanship for use under normal care. The capacity of the filter cartridge depends upon the amount of impurities in the water to be processed.

Except as otherwise expressly provided above, Multipure makes no warranties, express or implied, arising by law or otherwise, including without limitation the implied warranties of merchantability and fitness for a particular purpose, to any person. This limited warranty may not be altered, varied, or extended except by a written instrument executed by Multipure. The remedy of repair or replacement as provided under this limited warranty is exclusive. In no event shall Multipure be liable for any consequential or incidental damages to any person whether occasioned by negligence of the manufacturer, including without limitation damages of loss of use, cost of substitution, property damage, or other monetary loss.

Warranty is valid only if the system is operated within conditions listed herein. The warranty begins from the date of purchase.

**Electronic Warranty:** 60 Months

# Contaminant Reduction Performance

## Product Certifications



The Aqualuxe is NSF-certified to reduce a broad array of contaminants of aesthetic and health concern. The following are contaminants treated by the Aqualuxe.

### NSF/ANSI Std. 42

- Chlorine
- Chloramine
- Nominal Particulate Reduction, Class 1 (Sub-micron)
- Taste & Odor Reduction

### NSF/ANSI Std. 53

- Arsenic V
- Asbestos
- Chlordane
- Cyst
- Lead
- Mercury
- Microcystin
- MTBE
- PCB
- PFOA/PFOS
- Toxaphene
- Turbidity
- VOC (Full list on pg 18)

### NSF/ANSI Std. 401: Emerging Contaminants

- Atenolol
- Bisphenol A
- Carbamazepine
- DEET
- Estrone
- Ibuprofen
- Linuron
- Meprobamate
- Metolachlor
- Microplastics
- Naproxen
- Nonyl phenol
- Phenytoin
- TCEP
- TCPP
- Trimethoprim

### NSF Protocol P231

- Bacteria
- Viruses

## Arsenic Facts (in compliance with NSF/ANSI standards)

Arsenic (abbreviated As) is a naturally occurring contaminant found in many ground waters. Arsenic in water has no color, taste, or odor, and must be measured by lab testing. Public water utilities must have their water

tested for arsenic, and their results can be obtained from your local water utility. If you have your own well, the water can be tested; your local health department or state environmental health agency can provide a list of certified testing labs. Information about arsenic in water can be found on the Internet at the U.S. Environmental Protection Agency website, at <http://water.epa.gov/lawsregs/rulesregs/sdwa/arsenic/index.cfm>.

There are two forms of arsenic: pentavalent arsenic (also called As(V), As(+5), and arsenate) and trivalent arsenic (also called As(III), As(+3), and arsenite). In well water, arsenic may be pentavalent, trivalent, or a combination of both. Special sampling procedures are needed for a lab to determine what type and how much of each type of arsenic is in the water. Check with the labs in your area to see if they can provide this type of service.

Specially formulated Carbon Block systems are very effective at removing pentavalent arsenic. A free chlorine residual will rapidly convert trivalent arsenic to pentavalent arsenic. Other water treatment chemicals such as ozone and potassium permanganate will also change trivalent arsenic to pentavalent arsenic. A combined chlorine residual (also called chloramine) may not convert all the trivalent arsenic. If you get your water from a public water utility, contact the utility to find out if free chlorine or combined chlorine is used in the water system.

The Multipure Aqualuxe is designed to remove only pentavalent arsenic. The Aqualuxe will not convert trivalent arsenic to pentavalent arsenic. The system may remove some trivalent arsenic; however, it has not been evaluated for its ability to remove trivalent arsenic. The system was tested in a laboratory to remove pentavalent arsenic. Under lab conditions, as defined in ANSI/NSF Standard 53, the system reduced 0.050 mg/L (ppm) pentavalent arsenic to 0.010 mg/L (ppm) (the U.S. EPA standard for drinking water) or less. The performance of the system may be different at your installation. Have the treated water tested for arsenic to check if the system is working properly.

The Carbon Block filter component of the Aqualuxe system must be replaced as indicated in this Owner's Manual to ensure the system will continue to remove arsenic and other contaminants.

## Volatile Organic Chemicals (VOC) List

The following VOCs are reduced by Multipure's Solid Carbon Block Filters.

### Disinfection Byproducts

- haloacetonitriles (HAN):
  - bromochloroacetonitrile
  - dibromoacetonitrile
  - dichloroacetonitrile
  - trichloroacetonitrile
- halo ketones (HK):
  - 1,1-dichloro-2-Propanone
  - 1,1-trichloro-2-Propanone
- trihalomethanes (THMs; TTHMs):
  - bromodichloromethane
  - bromoform
  - chloroform
  - dibromochloromethane
- tribromoacetic acid

### Herbicides

- alachlor
- atrazine
- 2,4-D
- dinoseb
- pentachlorophenol
- 2,4,5-TP (silvex)

### Chemicals

- carbofuran
- chloropicrin
- dibromochloropropane (DBCP)
- o-dichlorobenzene
- p-dichlorobenzene
- endrin
- ethylene dibromide (EDB)
- heptachlor
- heptachlor epoxide
- lindane
- methoxychlor

### Chemicals

- benzene
- carbon tetrachloride
- chlorobenzene
- 1,2-dichloroethane
- 1,1-dichloroethylene
- cis-1,2-dichloroethylene
- 1,2-dichloropropane
- cis-1,3-dichloropropylene
- ethylbenzene
- hexachlorobutadiene
- hexachlorocyclopentadiene
- simazine
- styrene
- 1,1,2,2-tetrachloroethane
- tetrachloroethylene
- toluene
- trans-1,2-dichloroethylene
- 1,2,4-trichlorobenzene
- 1,1,1-trichloroethane
- 1,1,2-trichloroethane
- trichloroethylene
- xylenes (total)

### Pesticides

- carbofuran
- chloropicrin
- dibromochloropropane (DBCP)
- o-dichlorobenzene
- p-dichlorobenzene
- endrin
- ethylene dibromide (EDB)
- heptachlor
- heptachlor epoxide
- lindane
- methoxychlor

# Troubleshooting

## Status lights on

Please refer to page 12 (Aqualuxe Status Panel) to understand what the status lights mean.

## Water flow is frequently interrupted by air

Purge any residual air from the system:

1. Turn the system housing upside down.
2. Turn on the filtered water faucet (either through the Aqualuxe faucet or the diverter valve).
3. Allow water to flow for one minute.
4. Turn off the filtered water faucet (either through the Aqualuxe faucet or the diverter valve).

## Odor – rotten eggs, no discoloration on the filter

A rotten egg odor is a sign that H<sub>2</sub>S (hydrogen sulfide) gas is present in your water source.

If hydrogen sulfide gas is present in your water source, it is recommended that you rotate DWS usage between 2 filter cartridges. When the DWS emits the rotten egg smell, remove the filter and allow it to dry upside down to allow the gas to dissipate (the filter can be reused once dry). Use the second filter in the unit while the first filter is drying.

## Odor – rotten eggs, with discoloration on the filter

A rotten egg odor is a sign that H<sub>2</sub>S (hydrogen sulfide) is present in your water source. Filter discoloration can determine the source:

- orange/brownish colors – iron
- blackish colors – manganese
- slimy/blotchy colors – decaying organisms

When hydrogen sulfide comes from a source that discolors the filter cartridge and creates a strong rotten egg odor, the only recommended solution is to change the filter cartridge.

## Color – milky color in the water

Milky color in the water is typically caused by air bubbles in the water. Higher than normal water pressure through the DWS can create these small air bubbles, but they do not affect system performance. Air in the water may also be the result of conditions in your municipal water supply.

For countertop systems, turn on the water and engage the diverter valve while slightly reducing the water flow. Less water pressure through the system can prevent air bubbles from forming.

## Color – black color in the water

Black color in the water is typically caused by residual carbon dust from the filter.

Allow water to run through the DWS for approximately 30 minutes to flush the filter. Residual carbon dust may initially color the water black.

### **Flow rate – the water flow rate is slow**

Flow rate – the water flow rate is slow The filter is designed to restrict its flow rate when clogged with particulates or other solid contaminants.

When the water flow rate slows to the point of inconvenience, it is time to replace the filter cartridge. If other water sources are on while using the DWS, turn them off to check if they are affecting the flow rate.

### **Taste/Odor – miscellaneous**

The carbon block filter may have become saturated with the tastes and odors treated in your drinking water.

To resolve this, change the filter.

### **Bypass lever – sticking (hard to move)**

Minerals in the water can build up on the diverter valve, causing the bypass lever to stick and preventing the buttons from being pressed easily.

A sticking bypass lever can be solved by lubricating it or by dissolving the mineral deposits.

Lubrication – requires vegetable oil; because lubrication does not dissolve the mineral deposits, it may need to be performed periodically.

1. Unscrew the diverter valve and remove from the faucet.
2. Pour a small amount of vegetable oil in the inlet hole.
3. Push the left and right buttons on the diverter valve several times to lubricate it thoroughly.
4. Reconnect the diverter valve to the faucet.

Dissolving – requires vinegar; may cause discoloration to the metal.

1. Unscrew the diverter valve and remove from the faucet.
2. Soak the diverter valve in a bowl of vinegar for 10 minutes.
3. Rinse the diverter valve and reconnect to the faucet.

### **Bypass lever – stuck (cannot be pressed)**

The bypass lever can occasionally become stuck due to the presence of air in the tubing. This can prevent the buttons from being pressed.

1. Unscrew the diverter valve and remove from the faucet.
2. Press the left and right buttons to test it. If they press in easily, then removing the diverter valve freed the air in the tubing.
3. Reconnect the diverter valve to the faucet.

# Frequently Asked Questions

## **Can the top locking panel on the Aqualuxe be used as a handle?**

No. The top locking panel works in conjunction with the rear locking panel and the housing top to create an airtight, waterproof seal for the pressure vessel. Using the top locking panel as a handle or lever to lift the system or turn the housing top can severely damage the housing.

## **Why can't I open the rear locking panel with the tubing connected?**

The rear locking panel is purposefully designed not to open while the QuickSecure adapter and tubing is connected to the system. This helps prevent the system from accidentally opening while it is still connected to the faucet or cold water line, therefore preventing accidental leaks or spills.

## **Will low pH or acidic water affect the filter?**

No. Mineral components can determine the pH of water, and minerals dissolved in solution in the water pass through the system unfiltered.

- pH 7 = neutral
- pH > 7 = alkaline
- pH < 7 = acidic

## **Does deionized water or soft water have an effect on Multipure water?**

No. Because Multipure filters do not treat the natural minerals dissolved in water, the hardness or softness of water has no effect on the resultant filtered Multipure water.

## **Can the Multipure system be connected to an icemaker?**

The Aqualuxe can be connected to the sink, refrigerator, water dispenser, or icemaker. Additional parts or accessories may be required, depending on the specific connection.

## **Can the Multipure system be used during an emergency or when the water is turned off?**

Yes. During an emergency or when the source water is off, you can hand pump or siphon water through the Multipure system. Hand pump kits and emergency kits are available from Multipure.

## **What causes white particles to appear in Multipure water when it is frozen or boiled?**

Because the Aqualuxe does not reduce any natural minerals present in water, these minerals may solidify when the water is frozen and appear as white flakes or specks when the water is melted or boiled.

Many natural minerals in water are beneficial to your health, and their existence in drinking water (in normal quantities) is not cause for alarm. Minerals can be removed by Reverse Osmosis technology, which is available through the Multipure AquaRO Drinking Water System.

### **Why does the Multipure system reduce Volatile Organic Chemicals, but not natural minerals?**

Minerals are dissolved in solution and do not have an actual physical size; thus, the minerals pass through the system unfiltered.

### **Should sediment be removed with a standard filter first?**

In areas with excessive sedimentation, pre-filtration can help extend the operational efficiency of the Multipure filter; however, in most areas it is unnecessary.

Multipure Drinking Water Systems utilize a double-filter mechanic. The outer material is a pre-filter that protects the solid carbon block from prematurely clogging with large sediment.

### **Why is the compressed solid carbon block filter more efficient than (loose) granular activated carbon filters?**

Multipure's densely compacted solid carbon block filters force water through microscopic pores of carbon – much smaller than those of granular activated carbon – thus more effectively reducing particulate matter and contaminants that affect the taste and odor of the water.

### **What is the difference between a “water softener” and a Multipure Drinking Water System?**

Water softeners are not designed to treat drinking water for contaminants; instead, they are designed to adjust the hardness (mineral content) of the water. Multipure systems do not remove dissolved minerals from the water, because natural minerals often found in water are considered beneficial to good health.

Soft water is often desirable for bathing and laundering purposes, and may extend the life of hot water heaters and boilers. However, soft water is not recommended for use on plants or lawns. Multipure recommends that you bypass a water softener when installing your Multipure Drinking Water System.

### **Can the Multipure Drinking Water System be used with untreated water?**

The Multipure system is not intended for use with water sources of unknown origin, and is recommended for use with municipally-treated water. Although the Aqualuxe is certified to remove microbiological contaminants including bacteria, cysts, and viruses, it may be advisable with questionable source water to disinfect the water first. To disinfect questionable source water, add 1/4 tsp. of household bleach per gallon of source water; the Multipure system will remove this solution from the water during the filtering process.



# Aqualuxe Accessories

## Below-Sink Kit (AQLUXECT)

This installation kit includes a stand-alone chrome faucet and the necessary hardware to install the system below the sink. The system connects to the cold water line with an included Adapta Valve, and the faucet requires a 0.5" hole available in the countertop or sink for installation.

A below-sink Aqualuxe can be removed and converted for countertop use with additional parts.

## Countertop Kit (AQLUXEBS)

This installation kit includes a dual-hose diverter valve to connect to the sink faucet, providing push-button selection of either filtered or unfiltered water.

A countertop Aqualuxe is generally intended for use where below-sink installation restrictions are present (e.g., apartment use or lack of below-sink space), although it can be converted for below sink use with additional parts.

## Aqualuxe Replacement Filter (CBLX)

The Aqualuxe replacement filter utilizes FilterSync technology for optimal performance, and is certified to treat aesthetic contaminants, health contaminants, emerging compounds, and microbiological contaminants (bacteria, cyst, virus).

More Information and Products at  
[www.multipure.com](http://www.multipure.com)

---

Certification is only on the plumbed-in to separate tap option and the additional parts are not Certified.

If this device is not maintained or operated as specified in this owner's manual, there is a risk of exposure to contaminants. This drinking water filtration system is certified for the reduction of contaminants such as Lead, Mercury, VOCs, Cysts & Toxaphene. For the complete list of contaminants and more information, visit the manufacturer's website at [www.multipure.com](http://www.multipure.com) or the California State Water Resources Control Board at <http://www.waterboards.ca.gov/>.

The compounds certified under NSF/ANSI 401 have been deemed as incidental contaminants/emerging compounds. Incidental contaminants are those that have been detected in drinking water supplies at trace levels. While occurring at only trace levels, these compounds can affect the public acceptance/perception of drinking water quality.

The system and installation to comply with state and local laws and regulations.

The system is not intended to convert wastewater or raw sewage into drinking water.



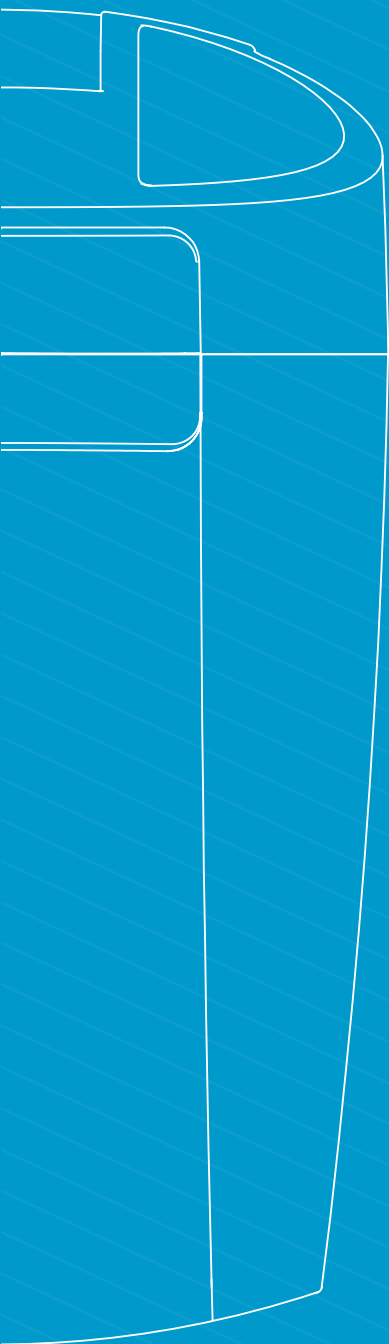

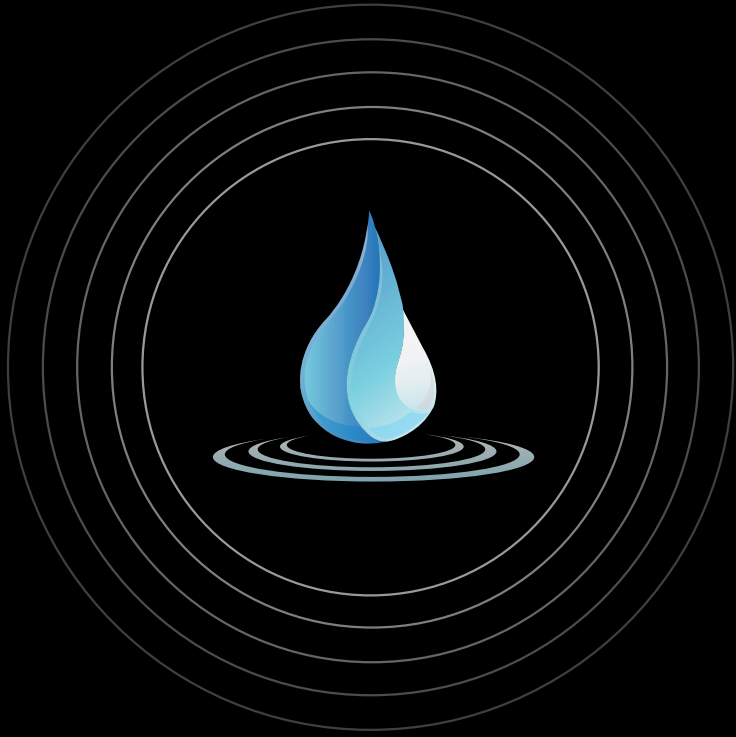

For Life. For You.

7251 Cathedral Rock Drive, Las Vegas, NV 89128  
702.360.8880 • 800.622.9206 • [www.multipure.com](http://www.multipure.com)