

AD-8127

Multi Printer

INSTRUCTION MANUAL



1WMPD4003327A

© 2016 A&D Company, Limited. All rights reserved.

No part of this publication may be reproduced, transmitted, transcribed, or translated into any language in any form by any means without the written permission of A&D Company, Limited.

The contents of this manual and the specifications of the instrument covered by this manual are subject to change for improvement without notice.

Windows and Excel are registered trademarks of Microsoft Corporation.

Contents

1. INTRODUCTION	2
1-1.Features	2
2. PRODUCT STRUCTURE (PART NAMES) , PACKAGE CONTENTS	3
2-1.Package contents	3
2-2.Part names	4
3. PREPARATIONS	5
3-1.Connecting the AC adapter	5
3-2.Opening and closing the printer cover	6
3-3.Installing and removing the ink ribbon	7
3-4.Installing the printer paper	8
3-5.Test printing	9
3-6.Connecting to the weighing device	9
4. PRINTING	10
4-1.Printing out data from the weighing device	10
4-2.Paper feed	10
4-3.Precautions	10
5. BASIC OPERATIONS OF THE KEYS	11
6. STATISTICAL CALCULATION FUNCTIONS	12
6-1.Printing example and printing contents of statistical calculation	12
7. BASIC SETTINGS	13
7-1.Time settings	13
7-2.Date settings	13
7-3.Printing mode settings	14
7-4.ID code setting	14
8. FUNCTION SETTINGS	15
8-1.Function settings display and operation keys	15
8-2.Items list	16
8-3.Initializing the function settings	18
8-4.Descriptions for the printing mode	19
8-5.Chart printing mode	20
8-6.Descriptions for the external input connector	21
9. INTERFACE SPECIFICATIONS	22
9-1.RS-232C	22
10. MAINTENANCE	23
11. TROUBLESHOOTING	23
11-1. Checking the printer performance	23
11-2. Asking for repair	23
12. SPECIFICATIONS	24
12-1. External dimensions	25
12-2. Sold separately	26

1. INTRODUCTION

This manual describes how the AD-8127 Multi Printer work and how to get the most out of them in terms of performance.

Read this manual thoroughly before using the printer and keep it at hand for future reference.

1-1. Features

- This device is a printer used to connect to a weighing device such as A&D's electronic balance, scale, counting scale, moisture analyzer, vibro viscometer or weighing indicator and print out data transmitted from the weighing device.
- With dot matrix printing, the printed contents can clearly and easily be viewed, allowing for storage of records for a long period of time.
- Light weight and compact size of the printer enables it to be set up in various locations and be easily transported.
- The printer is equipped with the RS-232C or current loop interface for data input, so it allows easy connections between the printer and a weighing device such as an electronic balance.
- Dust-free paper sold separately is available for using the printer in cleanrooms (AX-PP137-S).
- Built-in clock function of the printer enables printing out of the date and time.
- Printing at a regular interval is possible. (Interval printing)
- Statistical calculation results of the weighing data, including standard deviation, can be printed out.
- Time series variation of the weighing data in chart form can be printed out.
- The liquid crystal display provides easy conditions confirmation and settings of the printer.
- By pressing the key switch of the printer, a re-zero command to zero the display and request commands for the weighing data can be transmitted to an electronic balance, so the weighing data can be printed out without touching the highly sensitive electronic balance.

2. PRODUCT STRUCTURE (PART NAMES) , PACKAGE CONTENTS

2-1. Package contents

Main unit

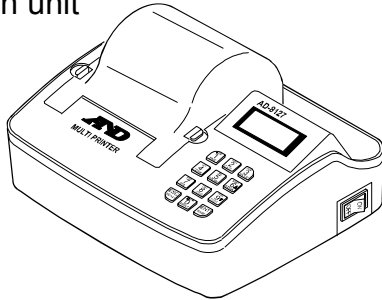

Ink ribbon (1 pc)

* The ink ribbon for test printing is installed to the main body.

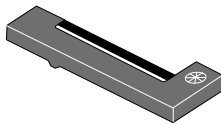

Ordinary printer paper (1 pc)

* Attached to the main body

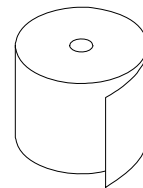

AC adapter

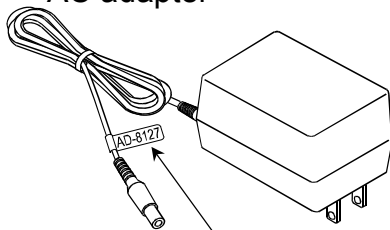

AC adapter labels



English instruction manual
(This document)

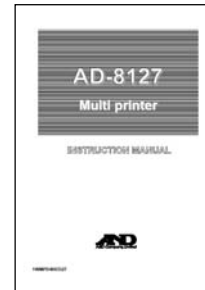

Japanese instruction manual



Position of placing
AC adapter labels

Confirm that the adapter type is correct for the local voltage and power receptacle type.

RS-232C cable

* RS-232C cables A, B or C below will be provided by specifying at time of order.

D-sub9 pin - 9 pin (AX-KO2741-100)	D-sub25 pin - 9 pin (AX-KO2116-090)	DIN - D-sub9 pin (AX-KO1786-200)	DIN - D-sub9 pin (AX-KO5291-050) * For current loop
A		B	
		C	

Sold separately

- Ink ribbon (5 pcs) AX-ERC-22B
- Ordinary printer paper (10 pcs) AX-PP137-S
- Dust-free printer paper (10 pcs) AX-PP173-S

2-2. Part names

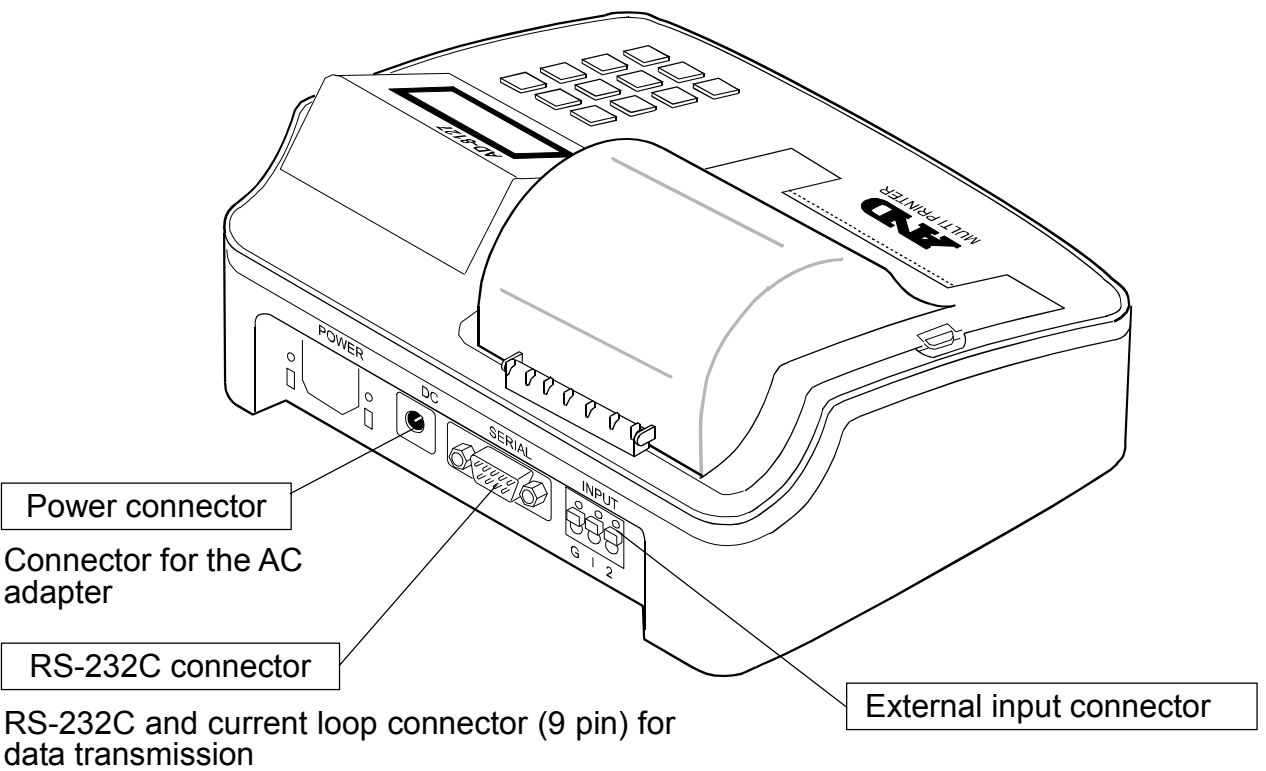
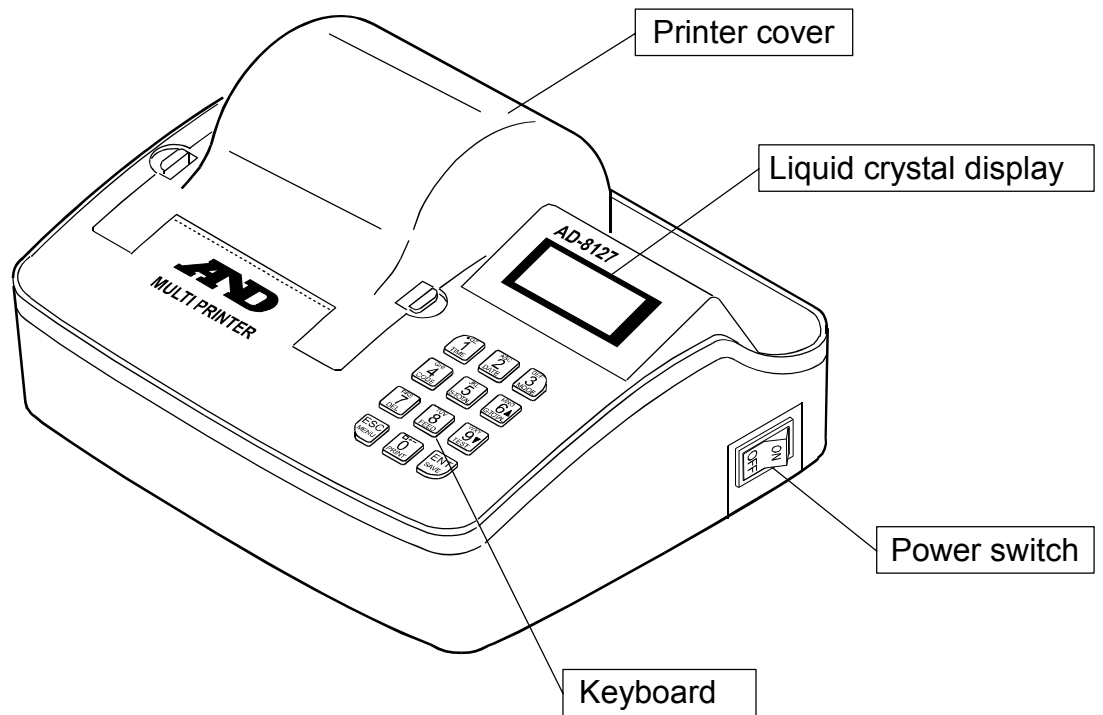

3. PREPARATIONS

3-1. Connecting the AC adapter

Instructions

1. Confirm that the power switch is turned to off.
2. Connect the DC plug of the AC adapter to the power connector of the printer.
3. Connect the AC plug to the outlet.

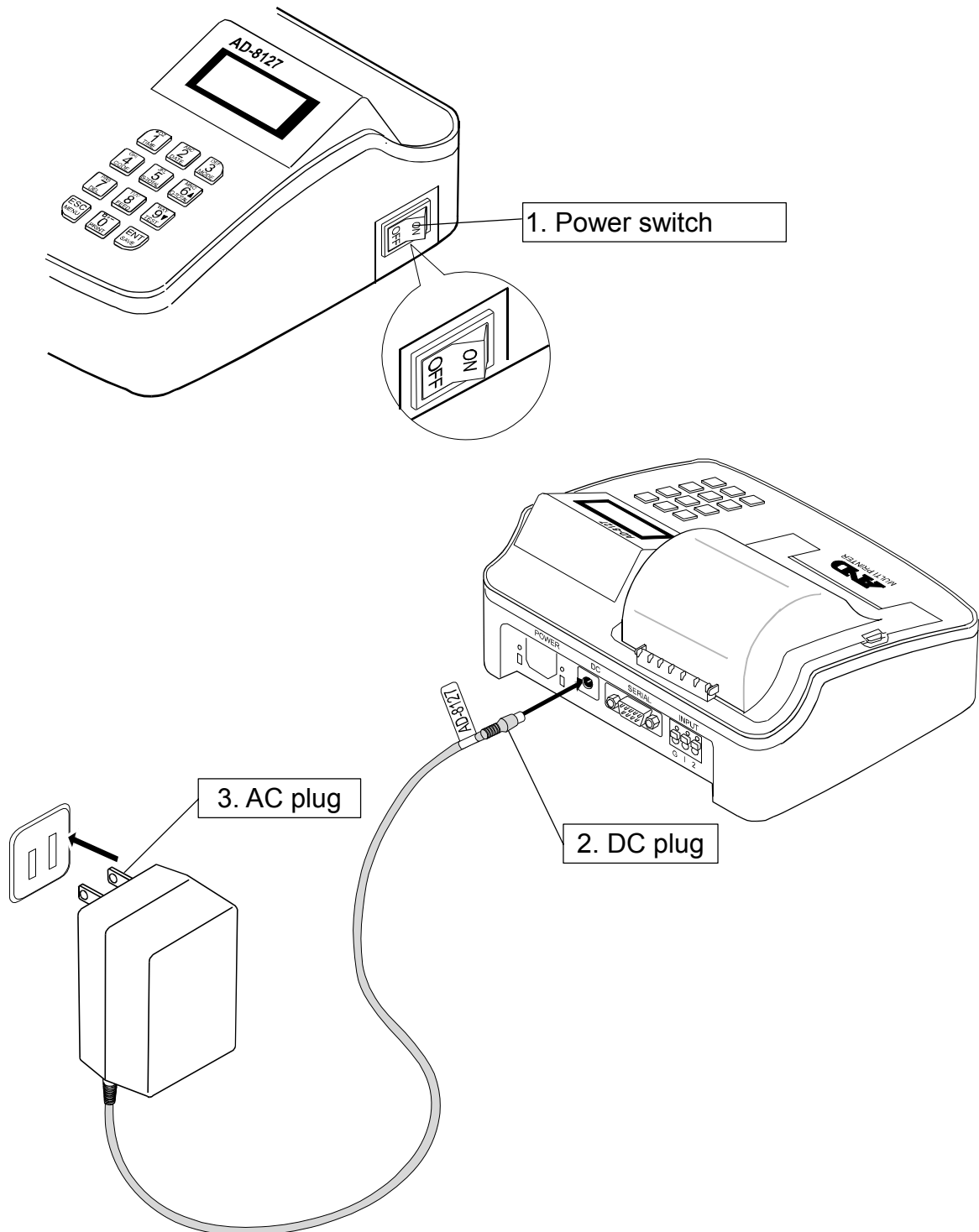

3-2. Opening and closing the printer cover

When installing and removing the ink ribbon and printer paper, open the printer cover to allow these operations to be performed.

Instructions

1. Push the knobs at both sides of the printer cover toward the inside (directions indicated by arrows).
2. Lift up the printer cover while keeping the knobs depressed.

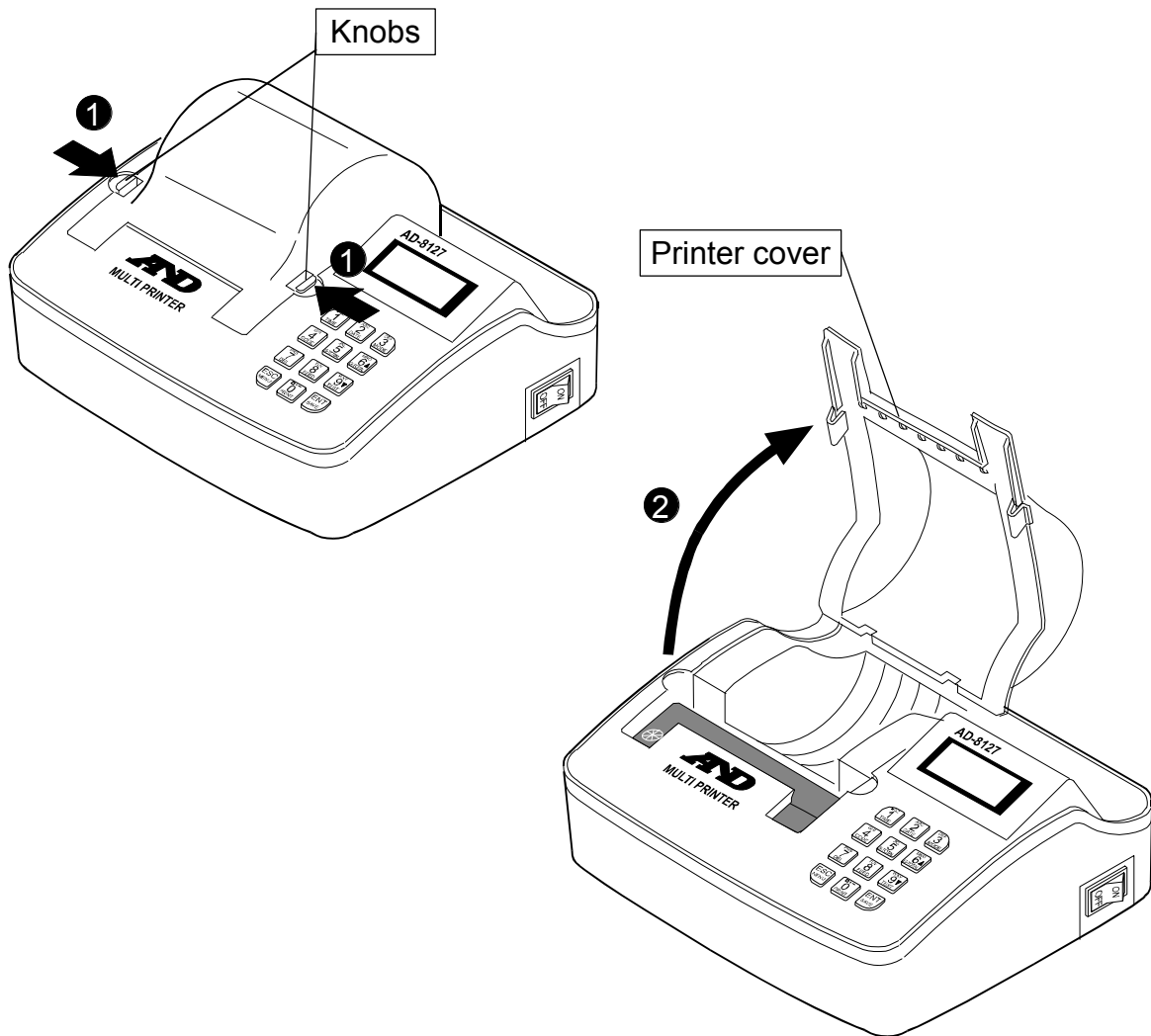

Note Opening or closing the printer cover improperly may result in damage to the printer cover.

3-3. Installing and removing the ink ribbon

Instructions

1. Turn the power off, and then open the printer cover.
2. When removing the ink ribbon, push the part indicated by “PUSH” on the ink ribbon to raise the knob side, and then lift up the ink ribbon straight.

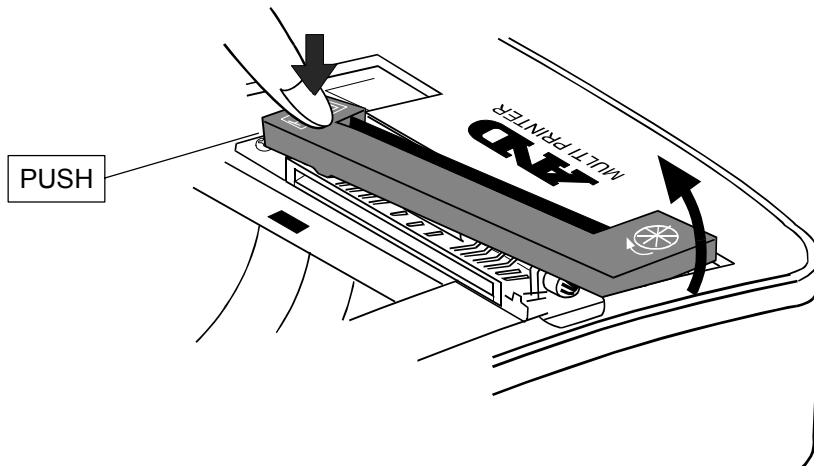

3. When attaching the ink ribbon, turn the ink ribbon's knob in the direction indicated by the arrow until there is no slack in the ribbon.
 4. Place the hole on the ink ribbon's knob rear side over the axis located on the main body. Insert the ribbon into the printing head and press the ink ribbon onto the main body.
- * When replacing the ink ribbon with printer paper attached, insert the ribbon between the printing head and printer paper.

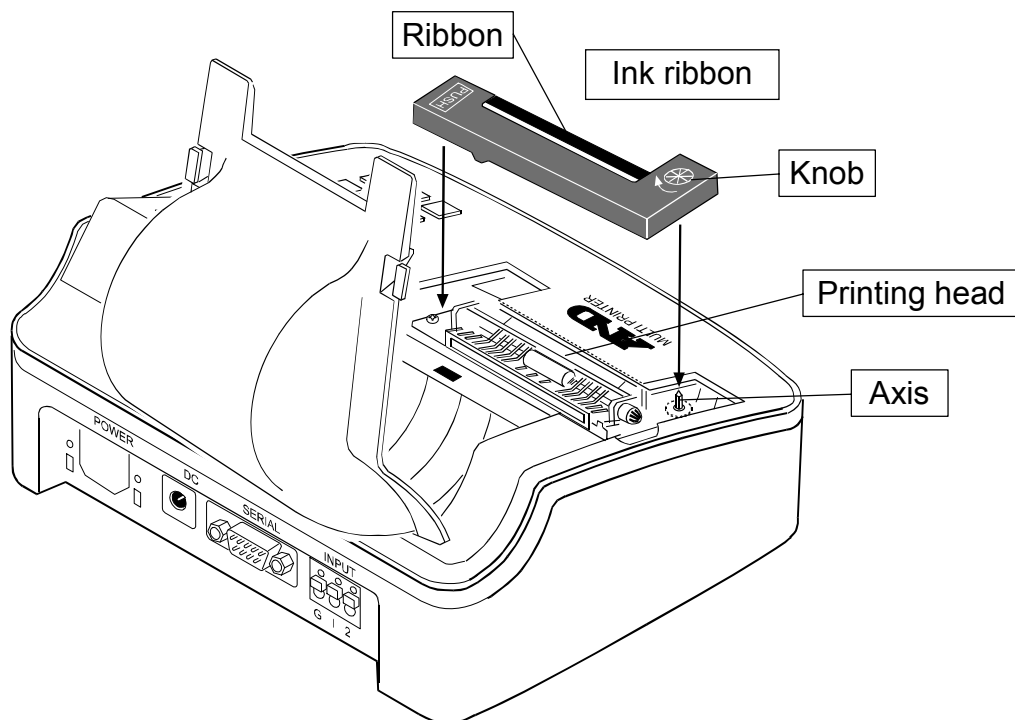



* Sold separately: ink ribbon (5 pcs) AX-ERC-22B

3-4. Installing the printer paper

Instructions

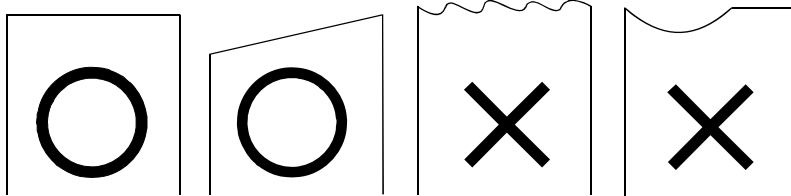
1. Open the printer cover.
2. Cut off the end of the printer paper at a right angle or obliquely as shown at the figure below.



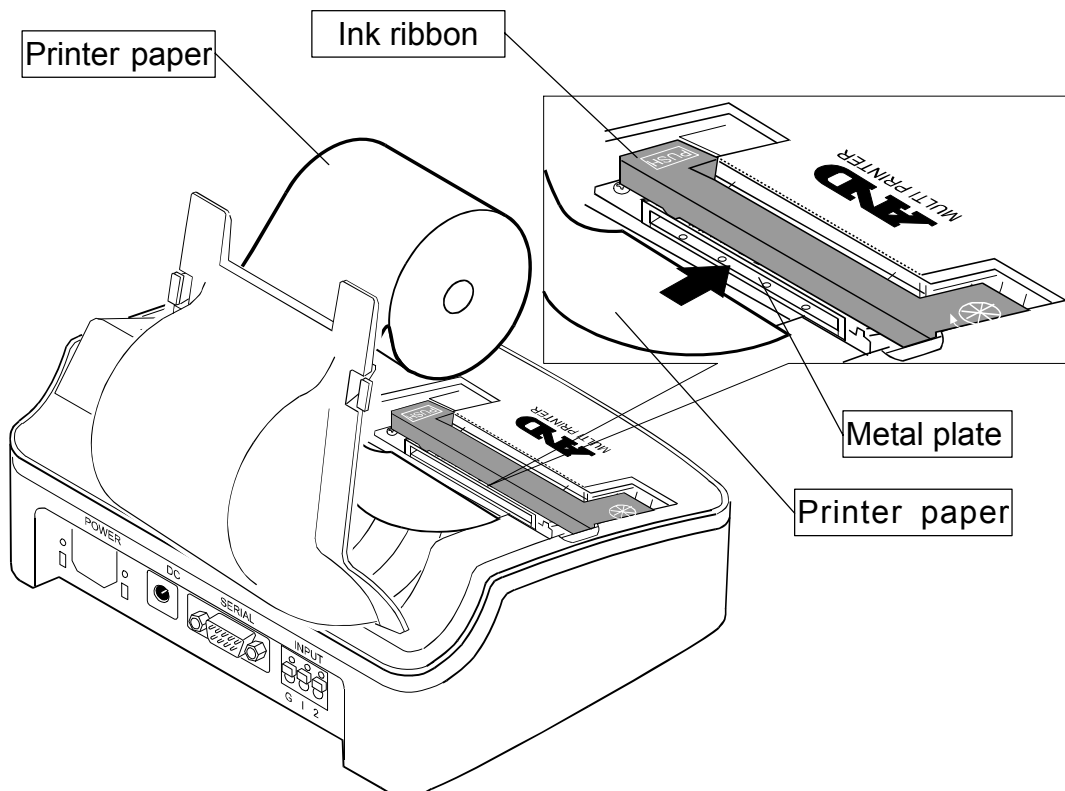

2. Insert the end of the printer paper onto the metal plate of the printing unit.
3. Turn the power switch on.
4. Press the  key to feed the printer paper 5 or 6 cm out of the printing unit.
5. Close the printer cover.



- * Place the paper roll in the printer cover to allow these operations to be done easier.
- * Sold separately: ordinary printer paper (10 pcs) AX-PP137-S
- Sold separately: dust-free printer paper (10 pcs) AX-PP173-S

3-5. Test printing

To start test printing, turn the power on while pressing and holding the  key, and then press and hold the  key.

By performing test printing, the status of the function settings can be confirmed.

Printout example

* To stop printing, turn the power off.

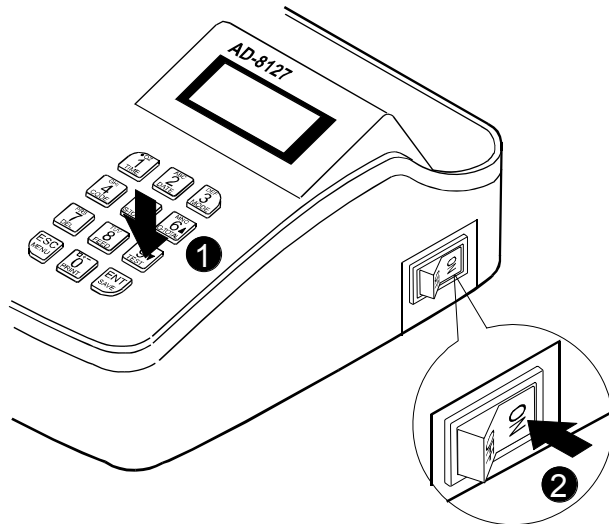

```

-----
*[* PRINTER SETUP ]*
VERSION :U3.13(2016/11/25)
USER MODEL : AND
PRINT MODE : EXT.KEY
PRINT FORMAT : WEIGHT
PRINT FORMAT2: +/- PRINT
US PRINT : NOT PRINT
DATE FORMAT : Y/M/D
SUB FORMAT : DEL
LINE FEED : 1 LINE
USER CODE : 00000001
TOTAL MODE : TIME PRINT
CODE DIRECTION : L <- R
CODE PRINT : PRINT
NO.PRINT : PRINT
INTERFACE : SERIAL(RS-232C)
                CURRENT LOOP
PROTOCOL : 2400bps,E,7,1
CURRENT TIME/DATE :
                2016/12/15 14:39:42
-----
    
```

3-6. Connecting to the weighing device

Use the RS-232C cable to connect the printer to the balance or scale.

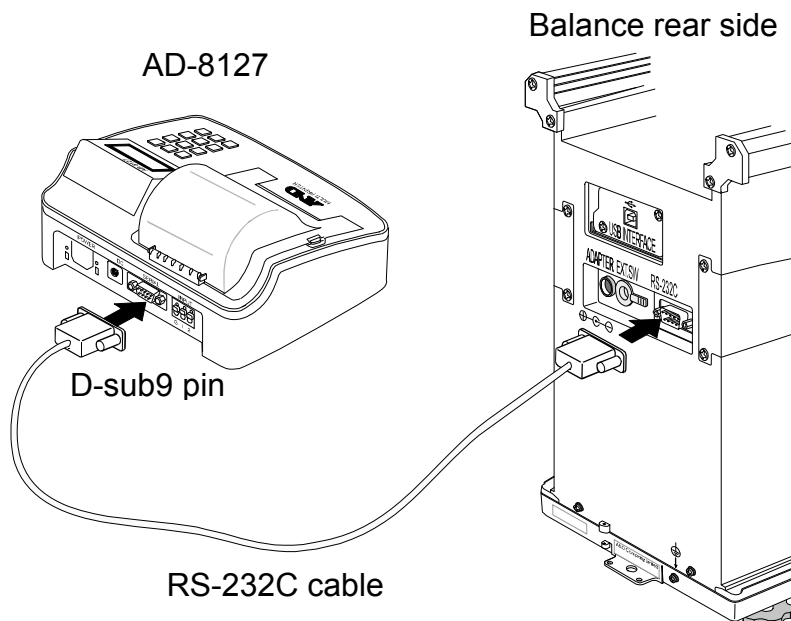



* Depending on the balance or scale models, there are three types of pin: D-sub9 pin, D-sub25 pin or Din7 pin. Use the cable that matches the specific type to connect the printer.

4. PRINTING

4-1. Printing out data from the weighing device

Instructions

1. Turn the printer power on.
 2. Connect the printer to the weighing device using a RS-232C or current loop cable.
 3. Transmit data to the printer from the weighing device.
Refer to the instruction manual of the weighing device for the data output methods, output format and RS-232C communication settings.
 4. Press and hold the  key to feed the printer paper until the printed results can be viewed, and then cut off the printer paper.
- * The balance has functions such as outputting by pressing the  key or automatically outputting after stabilizing the weighing.

4-2. Paper feed

Instructions

1. Press the  key to allow paper feed while the button is pressed.

4-3. Precautions

- Do not print with the ink ribbon detached. Doing so may cause damage in the printing head.
- Replace the ink ribbon with a new one before it becomes worn out due to excessive use. Failure to do so may cause damage to the printing head. Also, do not apply ink to the ink ribbon. Doing so may cause bleeding.
- Do not drop foreign matter into the printer. Doing so may cause mechanical damage to the printer.
- When operating the printer, install the printer in a stable location. Installing the printer in an uneven or unstable location may result in movement of the printer caused by vibration due to printing out, leading to a serious accident.
- Depending on a material (PVC, etc.) of the installation table, rubber may transfer to it from the printer. Do not set the printer on a table or sheet made of vinyl.
- When cleaning the main unit, do not use organic solvents such as alcohol, thinner, or benzene. Otherwise, that may cause damage to the printer as its main body is made of plastic.
- Keeping the ink ribbon attached to the printer a long time may result in the printer paper becoming dirty. Also, performing continuous printing at low temperature may result in faint printing due to characteristics of the ink.
- Attempting to print when out of paper could damage the printing head. Install new printer paper to the printer.
- The ink ribbon provided at shipping is for test printing.

5. BASIC OPERATIONS OF THE KEYS

There are two actions possible when pressing a key.

1. Press the key and release after the buzzer sounds
2. Press and hold the key and release after the buzzer sounds twice

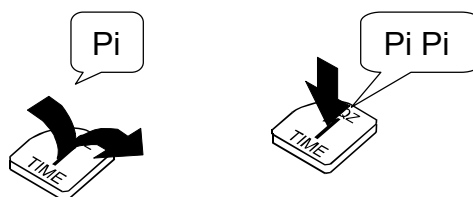

* To prevent errors when making key operations, there is an interval until the buzzer sounds after pressing the key.

Keys	When the key is pressed (Until the buzzer sounds one time)	When the key is pressed and held (Until the buzzer sounds twice)
	Prints out the current time.	Puts the printer in the time settings mode.
	Prints out the current date.	Puts the printer in the date settings mode.
	Accesses the printing mode settings.	
	Prints out the ID code.	Puts the printer in the ID code settings mode.
	Prints out the total.	
	Prints out the statistical calculation results.	
	Deletes one instance of the data to be used in statistical calculation.	Deletes all of the data to be used in statistical calculation.
	Feeds paper while the key is pressed.	
	Test prints when the power is turned on while pressing this key with the power turned off.	
	Cancels changes at each setting. Advances to the next setting item when configuring the function settings.	Transmits a re-zero command. * The commands can be selected at the function settings.
	Prints out weighing values in the manual printing mode. Prints out received weighing values after transmitting weighing value request commands ("Q" command) to the device at a mode other than manual printing mode. *	
	Confirms the setting changes. Stops or restarts the chart printing while printing a chart.	Toggles between the external key printing mode and dump printing mode. Completes the chart printing while printing a chart.

* When connecting using the current loop, the commands cannot be transmitted.

6. STATISTICAL CALCULATION FUNCTIONS

In addition to printing out weighing values, the printer can also perform statistical calculation of the weighing values printed out. The printer always performs calculation processing while operating, so you can print out calculation results at the touch of a key whenever needed.

6-1. Printing example and printing contents of statistical calculation

1. When printing out the weighing values, the weighing number is printed out.

If unit and kind of data entered in the printer differ from those of the data entered first, the printer prints out the values without calculating.

2. If accidentally printing out the weighing values, press the



key. “***< *** DELETE >***” is displayed and the printer does not calculate prior data.

3. When printing out total calculation results, press the



key. Date and time, ID code, data count (N) and total (TOTAL) are printed out.

4. When printing out all of the calculation results, press the



key.

Date and time, ID code, data count (N), total (TOTAL), averaging value (AVE), maximum value (MAX), minimum value (MIN), maximum value - minimum value (R), standard deviation (STDEV), coefficient variation (CV) and minimum weighing value (MINI WT) are printed out.

$$\text{Coefficient variation (CV)} = \frac{\text{Standard deviation (STDEV)}}{\text{Averaging value (AVE)}} \times 100(\%)$$

$$\text{Minimum weighing value (MINI WT)} = \text{standard deviation (STDEV)} \times 2000$$

* Calculation of the minimum weighing value conforms to USP Chapter 41. This calculation is applied only when weighing using a weight.

* Data count (N) to be calculated is a maximum of 999.

5. After printing out all of the calculation results, data to be used at statistical calculation can all be deleted.



key : To delete all of the data.



key : To not delete the data.

LCD display

CLEAR
DATA? E

Printout example

```
ID CODE : LAB-1234
NO. 1 WT 1000.12 9
NO. 2 WT 1000.20 9
NO. 3 WT 1000.16 9
NO. 4 WT 1000.21 9
```

< 004 DELETE >

```
NO. 4 WT 1000.25 9
NO. 5 WT 1000.13 9
```

```
***< SUB TOTAL >***
2016/02/09 15:31:50
ID CODE LAB-1234
N 5
TOTAL 5000.86 9
```

```
***< GRAND TOTAL >***
2016/02/09 15:32:07
ID CODE LAB-1234
N 5
TOTAL 5000.86 9
AVE(x) 1000.17 9
MAX 1000.25 9
MIN 1000.12 9
RANGE(R) 0.13 9
STDEV(s) 0.054 9
CV 0.01 %
MINI WT 107.15 9
```

7. BASIC SETTINGS

The basic settings allow easy key operations to perform minimum required settings such as clock and printing mode. The setting values are always backed up using the built-in battery, so those values are maintained in the memory even when the power is turned to OFF or the AC adapter is disconnected.

Note If an alarm such as one long beep followed by three short beeps sounds when the power is turned to ON, the printer is prevented from printing properly and configuring settings for date and time due to an error in the built-in lithium battery. In this case, the printer requires repair.

7-1. Time settings

1. Press and hold the  key.

2. Enter the hour, minutes and seconds by using the numerical keypad.

3. The display shows  when all data is entered.

4. To confirm the entered data, press the  key.

To cancel the entered data, press the  key.

* Do not set a time that does not exist to the printer.

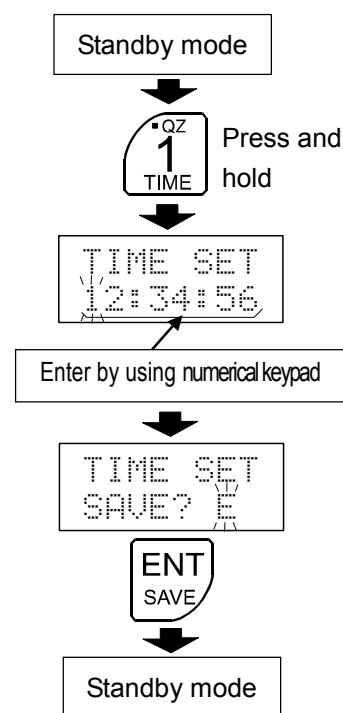



7-2. Date settings

1. Press and hold the  key.

2. Enter the year, month and day by using the numerical keypad.

3. The display shows  when all data is entered.

4. To confirm the entered data, press the  key.



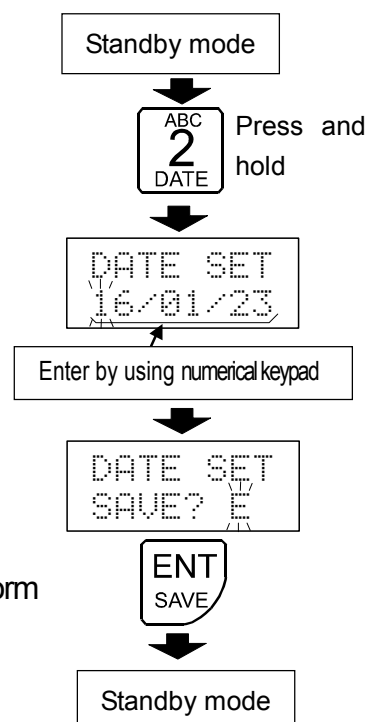

To cancel the entered data, press the  key.

* Do not set a date that does not exist to the printer.

* When changing the order of year, month and day, set by "Date form (DATE FOR)" of "Function settings (3=MODE)" in "8-2. Items list".



7-3. Printing mode settings



1. Press the  key.
2. Press the  or  key to switch the display.
3. Press the  key to confirm the setting.

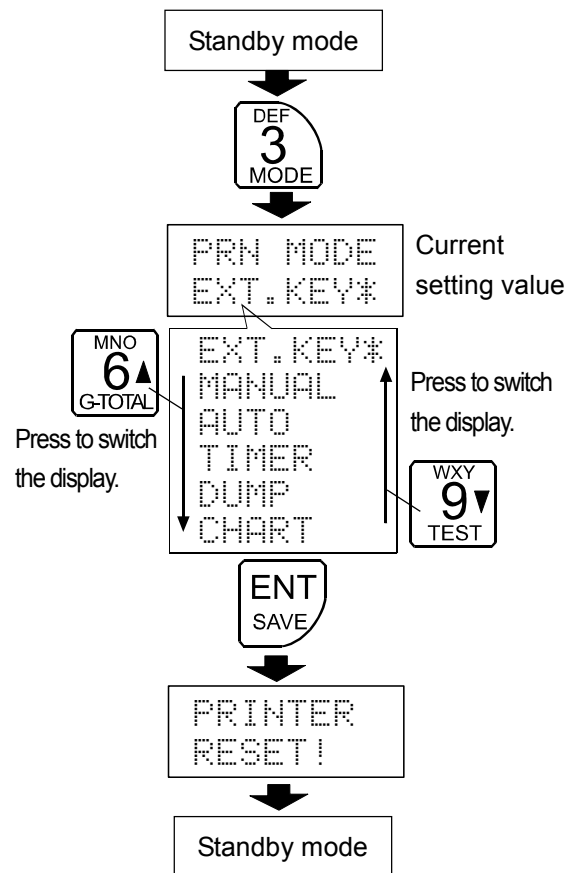

To cancel the setting, press the  key.

* Refer to “8-4. Descriptions for the printing mode” for descriptions of the each setting.



7-4. ID code setting

1. Press and hold the  key.
2. Enter the ID code by using the numerical keypad.
3. To move the digit to be entered, press the  key.
4. When the digits to be changed are all entered,  is displayed, and then the printer returns to the standby mode.

* Even if the  key was pressed to cancel settings, any digits where the  key has been pressed will be changed.

* Direction in which the ID code is set can be changed using the function settings.

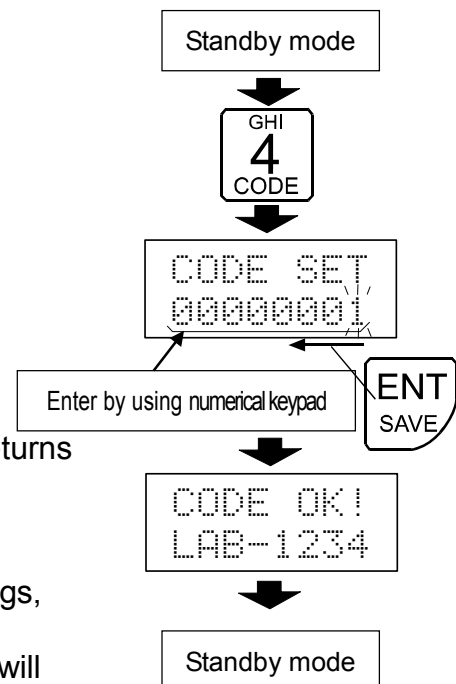

8. FUNCTION SETTINGS

The function settings are available for changes to communications and functions of the printer. These parameters are maintained in non-volatile memory, even if the AC adapter is removed. This function table menu consists of two layers. The first layer is the "Class" and the second layer is the "Item". Each item has one setting value registered. A setting value confirmed by pressing the

ENT SAVE key after selecting the item becomes effective.

New parameters are applied to the printer's operations after the **ON:OFF** key is pressed.

Settings example and menu structure

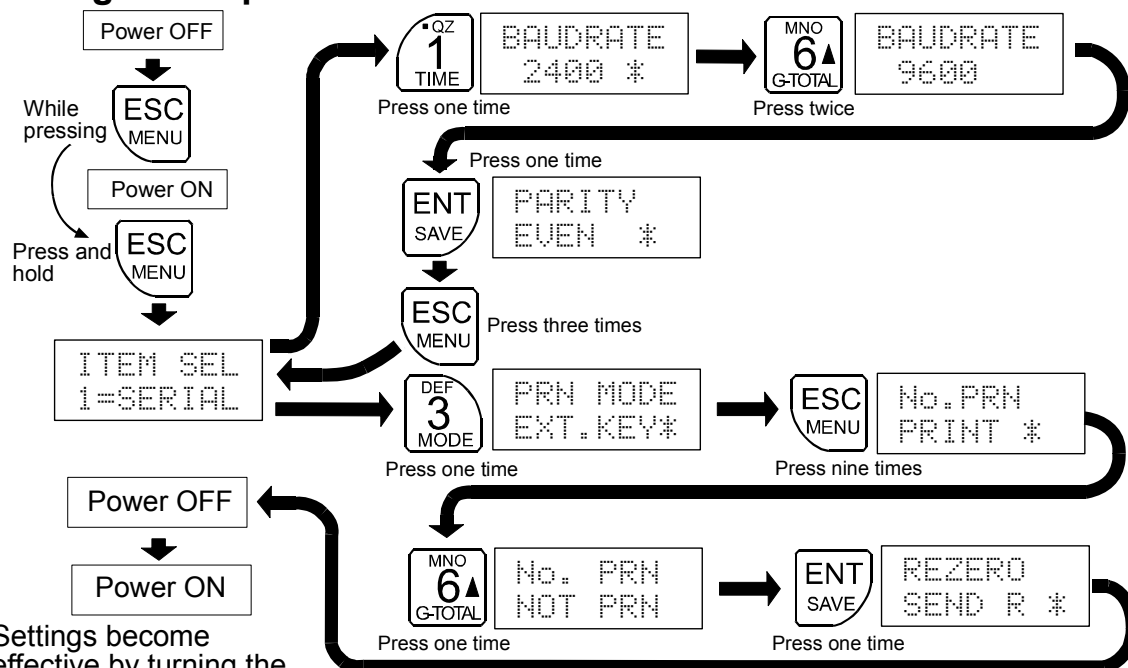

* Settings become effective by turning the power off and on again.

8-1. Function settings display and operation keys

Display and operation keys	Descriptions
	Currently enabled setting values are indicated by the " *" mark being lit.
	Accesses menu for the item selected when "ITEM SEL" is displayed.
	Changes settings values.
	Changes current item and advances to next item.
	Advances to next item without changing current item.

8-2. Items list

Class	Items	Setting values	Details and usage	
1=SERIAL Serial interface * 1	BAUDRATE Baud rate	300	300 bps	
		600	600 bps	
		1200	1200 bps	
		■ 2400	2400 bps	
		4800	4800 bps	
		9600	9600 bps	
		19200	19200 bps	
	PARITY Parity	NONE	Not used	
		ODD	Odd	
		■ EVEN	Even	
WORD LEN Data length	8 bit	8 bit		
	■ 7 bit	7 bit		
STOP BIT Stop bit	■ 1STOP	1 bit		
	2STOP	2 bit		
2=VENDER Data format *2		■ AND	A&D standard format	
		⋮ •	Subsequent values are for other-company format.	* 3
3=MODE Function settings	PRN MODE Printing mode	■ EXT.KEY	External key printing mode	
		MANUAL	Manual printing mode	* 4
		AUTO	Auto printing mode	* 4
		TIMER	Interval printing mode	* 4
		DUMP	Dump printing mode	
	PRN FOR. Printing data	■ WEGHIT	Weighing values only	
		TIME/US	Date and time + weighing values	
		TM1/US	Date and time + weighing values	Prints out date and time only at first operation.
	PRN FOR2 Printing data 2	+ PRN	Prints out when the weighing values are at "+".	
		■ +/- PRN	Prints out when the weighing values are at "+" and "-".	
	US PRN Unstable data	■ NOT PRN	Not printed out	
		PRINT	Printed out	
	DATE FOR Date form	■ Y/M/D	yyyy/mm/dd	
		M/D/Y	mm/dd/yyyy	
D/M/Y		dd/mm/yyyy		

■ indicates factory settings.

*1 Initial setting values of the serial interface are adjusted to those of an A&D balance or scale.

*2 We do not support operations of product formats other than A&D's standard format.

*3 Set the output format of the weighing device to A&D's standard format.

*4 The output mode of the balance or scale must be set to stream output.

Class	Items	Setting values	Details and usage	
3=MODE Function settings	FEED CNT Feed	■ 1 LINE	Feeds one line after printing.	
		2 LINE	Feeds two lines after printing.	
		3 LINE	Feeds three lines after printing.	
		4 LINE	Feeds four lines after printing.	
		5 LINE	Feeds five lines after printing.	
		6 LINE	Feeds six lines after printing.	
		7 LINE	Feeds seven lines after printing.	
		8 LINE	Feeds eight lines after printing.	
	TOTAL MD Calculation printing	■ T/D YES	Adds a date to the calculation printing.	
		T/D NO	Does not add date to the calculation printing.	
	CODE PRN ID printing	NOT PRN	Not printed out	When printing out No.1 data and statistical calculation
		■ PRINT	Printed out	
	CODE DIR ID setting direction	■ L ←→ R	To left from right	
		L →→ R	To right from left	
NO. PRN Weighing number printing	NOT PRN	Not printed out	Number to be applied to statistical calculation	
	■ PRINT	Printed out		
REZERO Re-zero command *5	■ SEND R	R command		
	SEND Z	Z command		

■ indicates factory settings.

*5 Set the command so as to match figures for the balance or scale connected.

Class	Items	Setting values	Details and usage	
3=MODE Function settings	EXT IN1 External input 1	■ NONE	Has no function.	
		PRINT	Printed out	Printing mode is "MANUAL" .
		FEED	Paper feed	
		G TOTAL	Calculation results printing	
		S TOTAL	Total printing	
		R/Z CMD	Re-zero command	
		Q CMD	Weighing value request command	
	EXT IN2 External input 2	■ NONE	Has no function.	
		PRINT	Printed out	Printing mode is "MANUAL" .
		FEED	Paper feed	* 6
		G TOTAL	Calculation results printing	
		S TOTAL	Total printing	
		R/Z CMD	Re-zero command	
		Q CMD	Weighing value request command	
4=INITIAL Initialization	PRN F/A Initialization	—	Resets the printer's function settings to factory settings.	

■ indicates factory settings.

*6 By pressing the external input switch one time, paper feed is started. By pressing the external input switch once again, paper feed is stopped.

8-3. Initializing the function settings

When resetting the function settings values of the printer to factory settings, perform "Initializing (4=INITIAL)" in "8-2. Items list".



key: Initializes function settings to factory settings.

LCD display



key: Cancels initialization

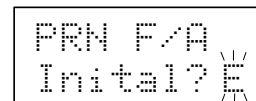

(The function settings are not initialized.)

8-4. Descriptions for the printing mode

Printing method of the printer varies depending on “Printing mode (PRN MODE)” in “8-2. Items list”.

External key printing mode (EXT. KEY)

Printing is done using weighing device’s keys without making printer key operations. Set data output settings of the weighing device to output using the keys.

It is also possible to print out data by pressing the  key to transmit a weighing value request command to the weighing device side. But when connecting using current loop, the commands cannot be transmitted.

Manual printing mode (MANUAL)

Printing can be done by pressing the  key.

Set data output settings of the weighing device to stream output (Always outputting).

Auto printing mode (AUTO)



Printing is done automatically when data transmitted from the weighing device has changes of +10 digits or more to zero and is stable.

One digit is the minimum display of the weighing device.

Set data output settings of the weighing device to stream output (Always outputting).

Interval printing mode (TIMER)

Printing is done at each time that was set by this mode. To set the interval time, set minutes and seconds (mm:dd) after confirming settings of the printing mode to “TIMER” .

To suspend the printing, press the  key. To restart the printing, press the  key.

Set data output settings of the weighing device to stream output (Always outputting).

Dump printing mode (DUMP)

Data transmitted from the weighing device is printed out without changes. Use these settings for GLP outputs, etc. of the weighing device.

Set data output settings of the weighing device to output using the keys.

Chart printing mode (CHART)

Amount of changes of the weighing values is printed out as scatter plot. Changes of the weighing values in real time can be confirmed visually.

At the chart printing mode, set digits (2 digits) for chart printing, minutes and seconds of the interval time (mm:dd) and the printing count after confirming settings of the printing mode to “TIMER”.

Set data output settings of the weighing device to stream output (Always outputting).

Refer to “8-5. Chart printing mode” for details.

8-5. Chart printing mode











1. Set the printing mode to "CHART" and press the  key to confirm.
2. Turn the power off and on.
3. Press the  or  key to select a digit to be transformed in chat and press the  key to confirm.
4. Enter the interval time by using the numerical keypad and press the  key to confirm.
5. Enter the chart printing number by using the numerical keypad and press the  key to confirm.

Chart printing starts.

Chart printing example

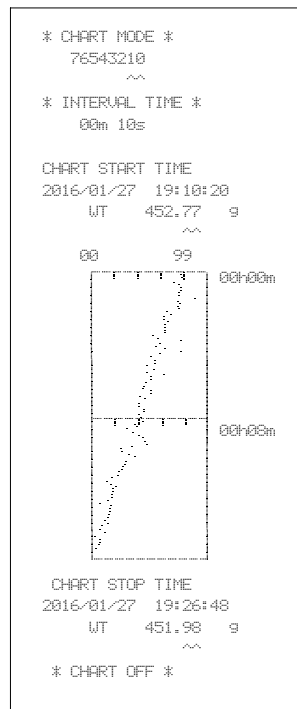

6. When the  key is pressed and held or the chart print count reaches the number of times that was set beforehand, the chart printing is completed. To stop the chart printing, press the  key. To restart the printing, press the  key.
7. To repeat the operations from "Step 2" after finishing chart printing, press the  key.

*1 Settings range of the interval time is 00 : 05 (5 seconds) to 59 : 59 (59 minutes 59 seconds).

*2 Settings range of the chart print count is 010 (10 times) to 990 (990 times) .

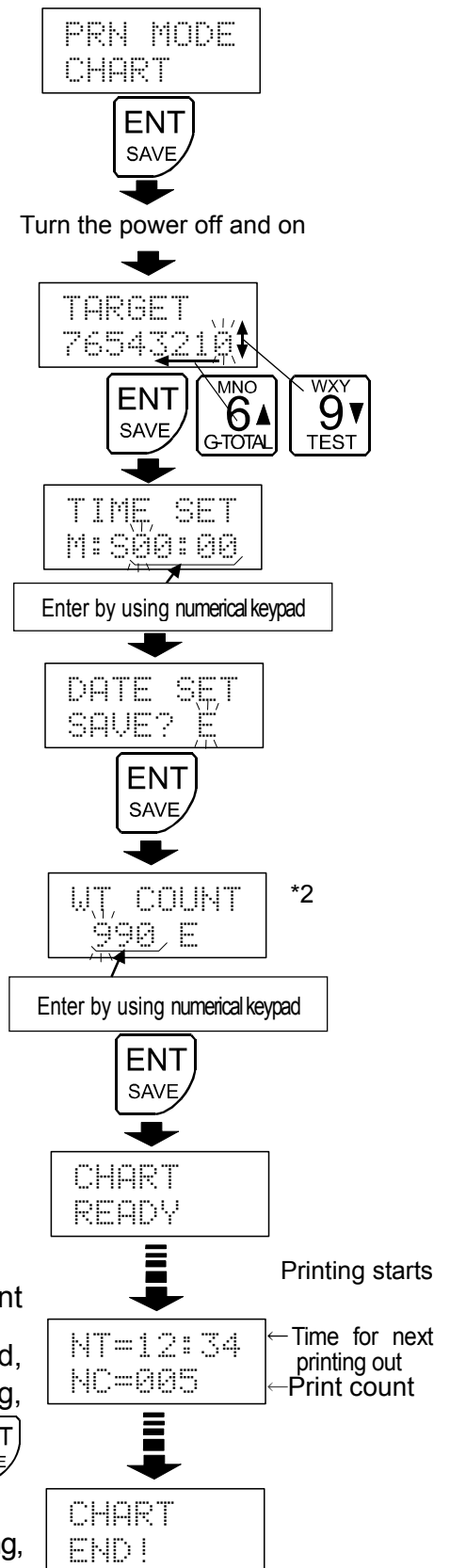

8-6. Descriptions for the external input connector

By using the external input connectors, operations such as printing, paper feed or re-zero on a weighing device away from the printer can be performed. The printer has two external inputs. Those operations can be set by “External input 1 (EXT IN1)” and “External input 2 (EXT IN2)” of “Function settings (3=MODE)” in “8-2. Items list”.

Combination example

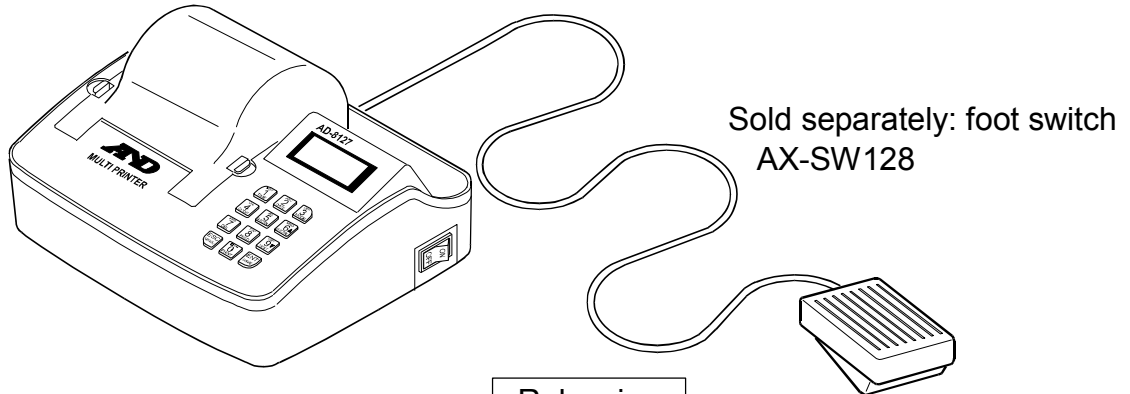

Using the external input connector (Example using a foot switch)

1. Strip the cable coatings to expose the conducting wire for approx. 1 cm.
 2. Secure the conducting wire using solder so that it cannot be bended or come apart.
 3. Insert either conducting wire into the “GND” terminal of the external input connector.
 4. Insert the other conducting wire into the “EX1” or “EX2” terminal of the external input connector.
 5. When removing the conducting wire from the external input connector, pull out the conducting wire while pressing the releasing button
- * If the conducting wire can not be secured properly by inserting, insert the conducting wire into the terminal while pressing the releasing button.
- * If the releasing button can not easily be pressed, depress the releasing button using a screwdriver.

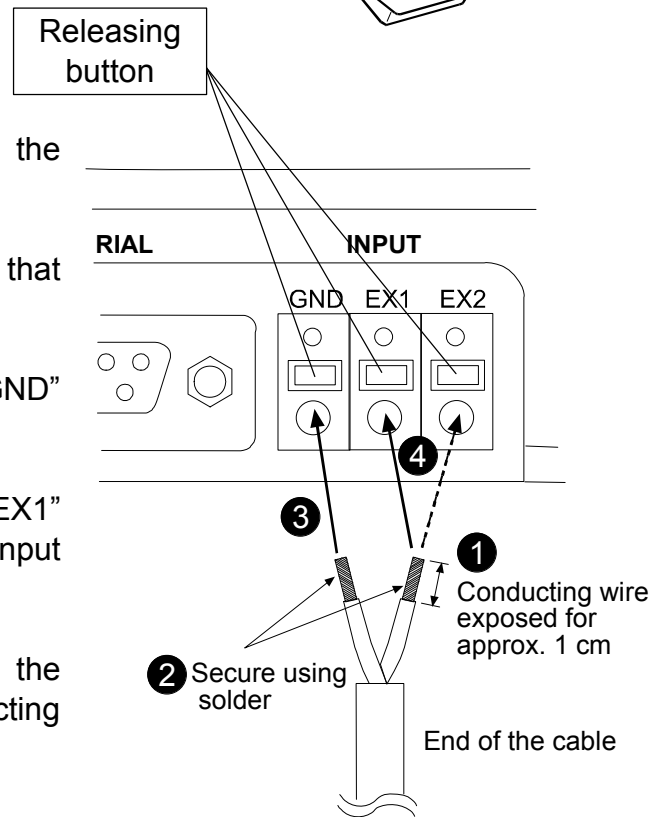

9. INTERFACE SPECIFICATIONS

9-1. RS-232C

The printer is a DTE device. Connect a balance (DCE) to the printer using a straight through cable.

- Transmission system : EIA RS-232C
- Transmission form : Asynchronous, bi-directional, half duplex
- Data format : Baud rate : 600, 1200, 2400*, 4800, 9600, 19200, 38400 bps
 Data length: 7* or 8 bits
 Parity : Even*, Odd (Data length 7 bits)
 None (Data length 8 bits)
 Stop bit : 1 bit

* indicates factory settings. (This is adjusted to factory settings for most of A&D's balances.)

D-Sub 9-pin assignment

Pin No.	Signal name	Direction	Description
1	RXD	—	Current loop receiving data
2	TXD	Output	Transmit data
3	RXD	Input	Receive data
4	Used internally	Output	Unavailable for connection (5V output)
5	SG	Output	Signal ground
6	—	—	No connection
7	—	—	No connection
8	—	—	No connection
9	—	—	No connection

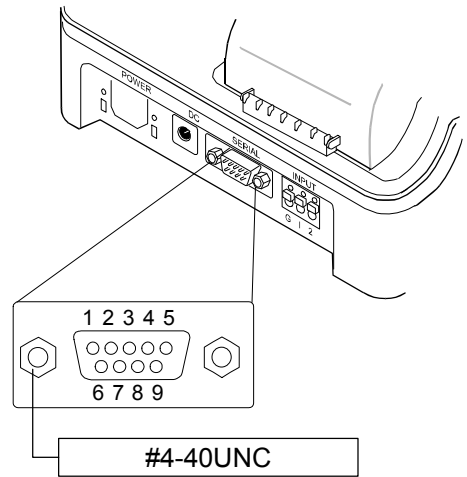

RS-232C connection

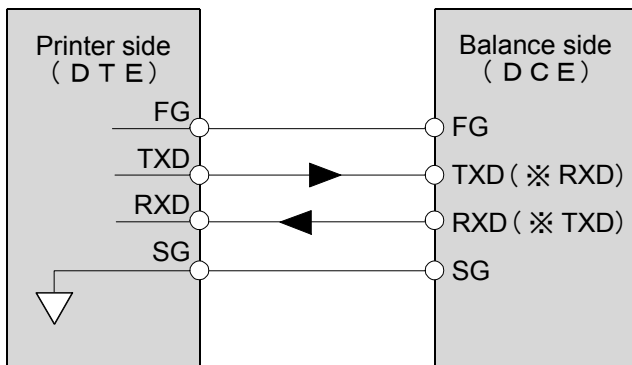

* The names in the parentheses are used for some balances in the instruction manual.

10. MAINTENANCE

- Do not use organic solvents or chemical cloth to clean the printer.
Clean the printer with a lint free cloth that is moistened with a mild detergent.
- Do not disassemble the printer.
- Use the original packing material for transportation.

11. TROUBLESHOOTING

11-1. Checking the printer performance

If the printer seems to have a problem, check the items described below.

If improper performance persists after checking, contact the local A&D dealer for repair.

Checking the power supply

- Is an appropriate AC adapter connected?

Checking the data transmission

- Is the printer connected to the weighing device using an RS-232C straight through cable or current loop cable?
- Are the RS-232C settings (baud rate, data length and parity) of the printer the same with those of the weighing device?

11-2. Asking for repair

If improper performance persists after checking, contact the local A&D dealer for repair.

The printer is a precision instrument. Use the original packing material for transportation.

12. SPECIFICATIONS

Printing method	Impact type dot matrix
Character specifications	7 dots × 9 dots 1.6 (W) × 3.2 (H) mm
Printing speed	Approx. 1.6 line per second
Paper feeding speed	Approx. 4 line per second
Number of characters printed	24 characters per line
Operating temperature range	0°C to 40°C
Operating humidity range	35% to 85%RH (No condensation)
Storage temperature range	-20°C to 60°C
Storage humidity range	10% to 90%RH (No condensation)
Interface	RS-232C, current loop
Power supply & AC adapter type	Supplied to the AC adapter Confirm that the adapter type is correct for the local voltage and power receptacle type.
External dimensions	174 (W) × 141 (D) × 87 (H) mm
Weight	Approx. 500g
Accessories	Ink ribbon (1 pc), ordinary printer paper (1 pc), AC adapter, AC adapter labels, instruction manual, RS-232C cable

12-1. External dimensions

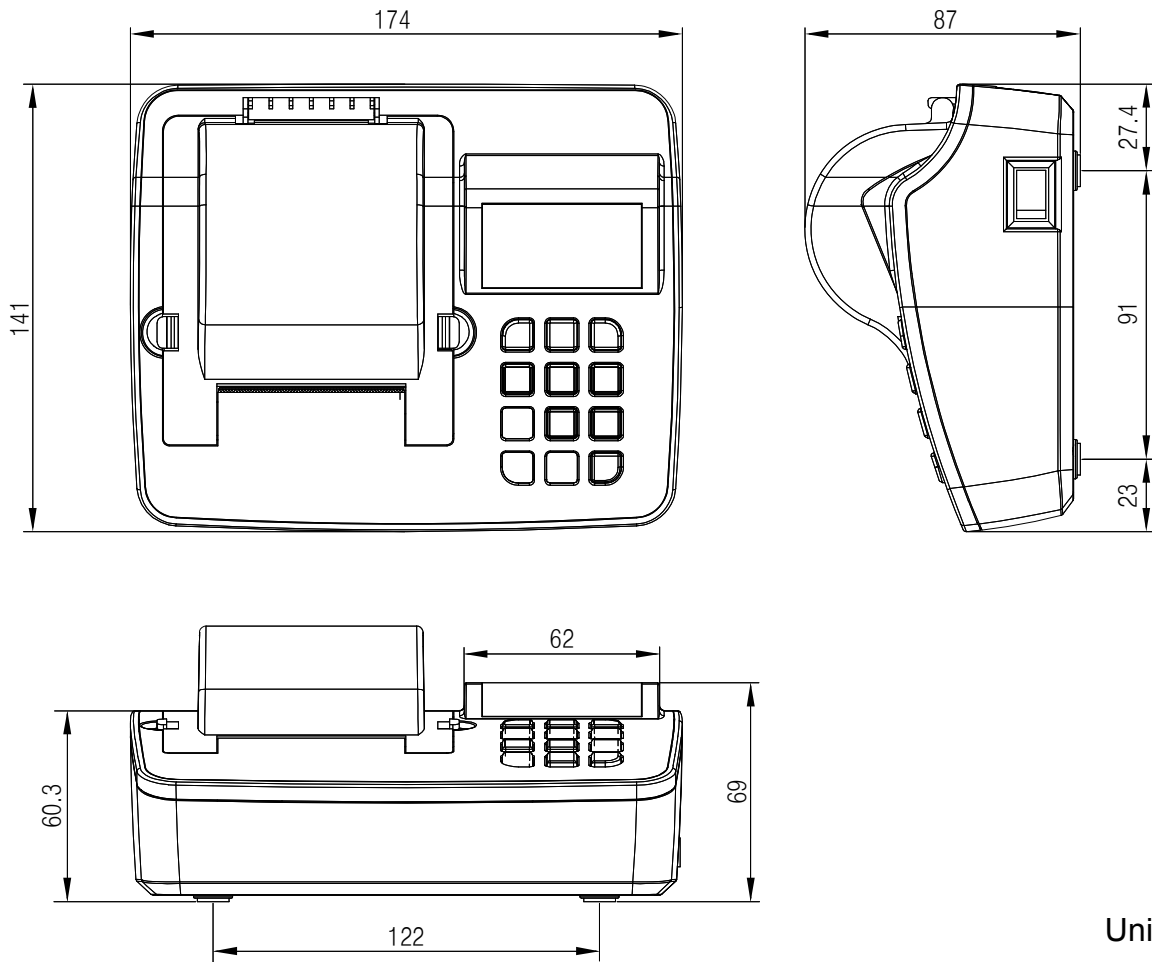

Unit: mm

12-2. Sold separately

Ordinary printer paper (10 pcs) AX-PP137-S

- This is ordinary replacement paper of 57.5mm width × Approx. 30m length.

Dust-free printer paper (10 pcs) AX-PP173-S

- This is dust-free paper that is available for use in cleanrooms.
57.5mm width × Approx. 30m length

Ink ribbon (5 pcs) AX-ERC-22B

- This is replacement ink ribbon.

RS-232C cable (D-sub9 pin – 9 pin, 1m) AX-KO2741-100

RS-232C cable (D-sub25 pin - 9 pin, 0.9m) AX-KO2116-090

RS-232C cable (DIN – D-sub9 pin, 2m) AX-KO1786-200

Current loop cable (DIN - D-sub9 pin, 0.5m) AX-KO5291-050

Foot switch AX-SW128

- By connecting the foot switch to the external input connector, functions assigned to the “External input 1 (EXT IN1)” and “External input 2 (EXT IN2)” of “Function settings (3=MODE)” can be performed.

MEMO

MEMO



A&D Company, Limited

3-23-14 Higashi-Ikebukuro, Toshima-ku, Tokyo 170-0013, JAPAN
Telephone: [81] (3) 5391-6132 Fax: [81] (3) 5391-6148

A&D ENGINEERING, INC.

1756 Automation Parkway, San Jose, California 95131, U.S.A.
Telephone: [1] (408) 263-5333 Fax: [1] (408)263-0119

A&D INSTRUMENTS LIMITED

Unit 24/26 Blacklands Way, Abingdon Business Park, Abingdon, Oxfordshire OX14 1DY United Kingdom
Telephone: [44] (1235) 550420 Fax: [44] (1235) 550485

A&D AUSTRALASIA PTY LTD

32 Dew Street, Thebarton, South Australia 5031, AUSTRALIA
Telephone: [61] (8) 8301-8100 Fax: [61] (8) 8352-7409

A&D KOREA Limited

한국에이.엔.디(주)
서울특별시 영등포구 국제금융로6길33 (여의도동) 맨하탄빌딩 817 우편 번호 150-749
(817, Manhattan Bldg., 33. Gukjegeumyung-ro 6-gil, Yeongdeungpo-gu, Seoul, 150-749 Korea)
전화: [82] (2) 780-4101 팩스: [82] (2) 782-4280

ООО A&D RUS

ООО "ЭЙ энд ДИ РУС"
121357, Российская Федерация, г.Москва, ул. Вереysкая, дом 17
(Business-Center "Vereyskaya Plaza-2" 121357, Russian Federation, Moscow, Vereyskaya Street 17)
тел.: [7] (495) 937-33-44 факс: [7] (495) 937-55-66

A&D INSTRUMENTS INDIA PRIVATE LIMITED

509, उद्योग विहार , फेस -5, गुडगांव - 122016, हरियाणा , भारत
(509, Udyog Vihar, Phase-V, Gurgaon - 122 016, Haryana, India)
फोन : 91-124-4715555 फैक्स : 91-124-4715599

ऐ&डी इन्स्ट्रुमेन्ट्स इण्डिया प्रा० लिमिटेड