



FAGOR AUTOMATION

CNC 8055

With the user in mind. More powerful than ever



CNC 8055

With the user in mind. More powerful than ever





Fagor Automation has been providing Automation solutions to the Machine Tool market for over 30 years with the emphasis on large batch production, small production runs and prototype applications which requires a versatile, yet powerful CNC solution.

The 8055 CNC provides perfect solution to both types of machining as it offers ISO G-code language highly suitable for high speed production based machining and the intuitive ICON key conversational programming language for small series or unitary work pieces where programming/set-up time is a crucial factor in determining the productivity of the machine.

The flexibility of 8055 CNC allows the possibility to combine both of these programming methods, thus increasing operator efficiency in addition to providing him with expanded capabilities

Integral solution

Fagor Automation has engineered and produced its CNC, Servo & Feedback products to work together as a unified system thus providing optimum performance and ease of operation.

When utilizing multiple different brands within a system, integrating them together in reliable harmony becomes cumbersome and often complicated.

Fagor Automation allows the integrators to have a single source for all vital Automation components with the confidence that all of these products have been designed & engineered with the direct intent of optimum performance, efficiency and reliability, thus greatly simplifying the Integration process.



Machining

high speed machining

During high speed machining operations, the 8055 CNC is in control of assuring smooth & accurate tool path without sudden accelerations or decelerations in order to obtain the most stable machining speed possible, thus avoiding part surface irregularities.

High speed

The 8055 CNC utilizes advanced algorithms that are required in high speed machining operations to obtain a tool path that is identical to the part programmed from a blueprint. Combined with its advanced calculating power, a large look-ahead buffer (200 blocks) and a high speed block processing time (capable of up to 1 millisecond), it can produce very accurate parts.

For non-rigid machine platforms that tend to vibrate under demanding conditions (high speed & frequent direction changes), the 8055 CNC offers jerk control, which creates a smooth gradual acceleration versus sudden speed changes that can cause mechanical vibrations. Implementing this type of advanced feature provides a double benefit. On one hand, the mechanical stress on the machine is lower, yet on the other hand, thanks to the reduced vibration, the axes movements are smoother thus allowing a higher feed rate coupled with an improved part finish.

High speed



Dynamic adaptation of machining operations

The Look-Ahead function considerably improves machining productivity. It is impossible to talk about high speed machining without including the Look-Ahead function. While executing a program, the look-ahead analyzes in-advance the tool path defined in the following blocks which are yet to be executed.

Thanks to this data, the CNC quickly adapts to the machining needs by maintaining the required feed rate and avoiding machining marks, corner rounding & sudden machine movements, etc.

Dynamic adaptation of machining operations

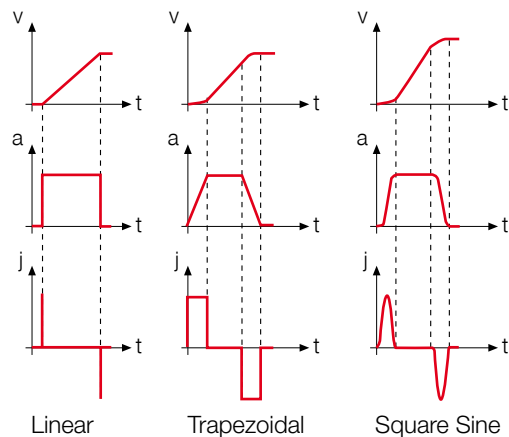

Work in inclined planes

The 8055 CNC can handle spindle and table articulations on the inclined surfaces of the part. Just program the part as usual, ignoring the inclination of the surface. Then define the inclination of the work surface and the CNC will orient the tool to make the programmed part on the defined surface.

Work in inclined planes



easier machine set-up

Graphically assisted set-up user interfaces, such as the oscilloscope function mode or the geometry test help ensure the CNC makes up for the possible lack of performance of the mechanical system by considering the particular dynamics of the machine.

Oscilloscope

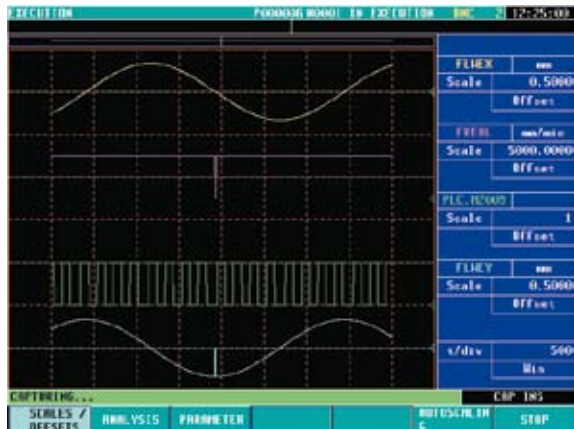

Oscilloscope

The on-board Oscilloscope function is an assistance tool for optimizing the performance of the Servo System by simulating in real time the performance characteristics of the machine through various machining conditions. This data greatly enhances the OEM's ability to choose the best parameter settings for the machine and apply the appropriate filters to correct any problems they may run into.

Circularity test

The circularity (roundness) test helps improve the performance of the machine when axes changes direction. By making a circular path, the OEM can graphically compare the real (actual) tool path with the theoretical, thus allowing the capability of selecting the best parameter settings to achieve a more accurate programmed tool path. Contradictory as it may seem, a machine can work more efficiently and even achieve faster cycle times while keeping or even improving the machining smoothness.

The benefits of graphic assistance tools for set-up combined with the intelligence of Look-Ahead feature helps create a smoother machine motion by gradually accelerating on smooth surfaces and by decelerating in the same manner in more complex axes positions.

Circularity test



Retrofit

All these tools are applicable for new machines and for those upgraded or retrofitted. Retrofitting consists in restoring a machine that has become obsolete or worn over time in order to bring back to life the productivity of the machine. The 8055 CNC allows the flexibility of retaining the existing analog servo system and even combine it with a digital system. This possibility of the 8055 CNC makes many of the retrofit projects not only feasible, but affordable too by removing any budget restraints user may have for the older machines.

Retrofit

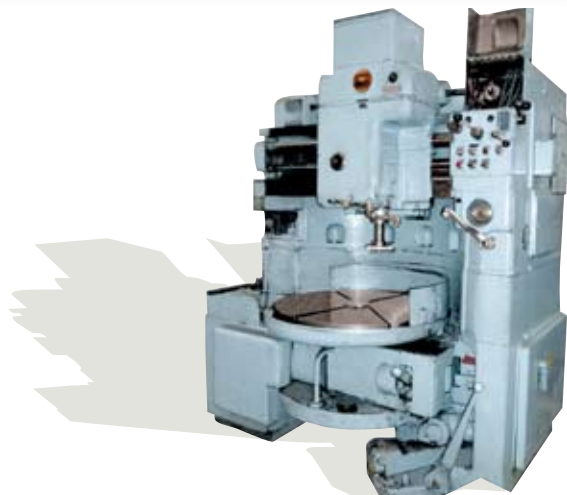

Operation

with the user in mind

The ICON based operations of the 8055 has been specifically designed for operators of conventional machines who lack prior programming knowledge such as ISO G-code language.

Fagor Automation's conversational language has been designed to make the operator's job as intuitive as possible, because of this; operators unfamiliar with Fagor CNC are capable of utilizing the 8055 CNC to its full potential in just a few hours.

It offers quick and efficient access, through ICON hot keys to the various operations and canned cycles. Each operation or cycle has a specific graphic ICON hotkey. You may simply press the key of the operation that you wish to perform, without having to browse through complex sub-menus, thus giving access to the relevant function immediately and without compromise.

Using Fagor Automation's ICON conversational mode, the machine can be used in manual mode without having to create a program.... Just fill in the blank on the graphic

screen based upon the blueprint data in hand and by capturing the tool position after moving it to the desired point (Teach-in).

Before the execution of the operation, it is easily possible to run a graphic simulation of the tool path by simply pressing the "graphic" hotkey. This may be used to check the end result and correct possible mistakes made when defining the operation cycle. The single cycles that have been executed earlier may be saved in a program so as to execute them in your chosen sequence at a later time. This allows checking a program in stages or layers before executing it as a whole program. The user can touch-up the programmed cycle when working with single cycles. When the cycle is part of a whole program by simply pressing the "Recall" hotkey, which automatically recalls all cycle data and allows for quick and easy editing.

Graphic help

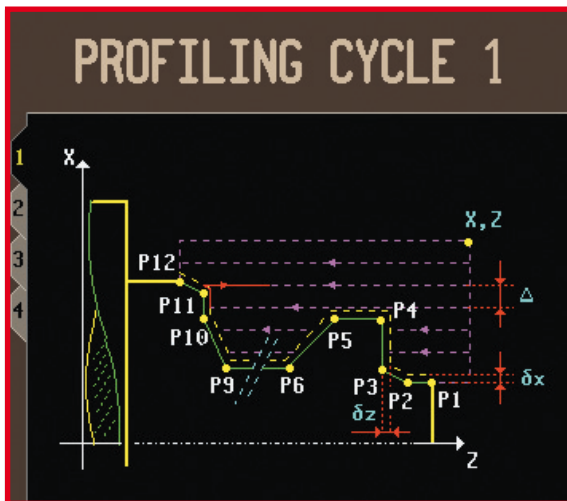

Geometry

F		0.0000
PROFILE DEF. (max.12 points)		
P1	X	0.0000
	Z	0.0000
P2	X	0.0000
	Z	0.0000
P3	X	0.0000
	Z	0.0000
Coordinates (X,Z)		
X	0.0000	Z 0.0000
Safety distances		
X	0.0000	Z 0.0000

The main CNC control interface shows the PROFILING CYCLE 1 screen. It includes a status bar at the top with time (17:42:00) and program number (346). The screen displays the same profile as the graphic help screen. Below the profile, there are fields for 'RANGE', 'FINISHING', 'SMAX', and 'FINISHING' with various settings and icons.

Machining conditions

CSS	RANGE	<input checked="" type="checkbox"/> ROUGHING		Δ	0.0000
	0	F 0.000 VCC	0 T 0 D 0	δ	
SMAX	0	<input checked="" type="checkbox"/> FINISHING		δ	0.0000
	0	F 0.000 VCC	0 T 0 D 0		

Intuitive browsing with hotkeys

Edit / verify / modify



Save the program

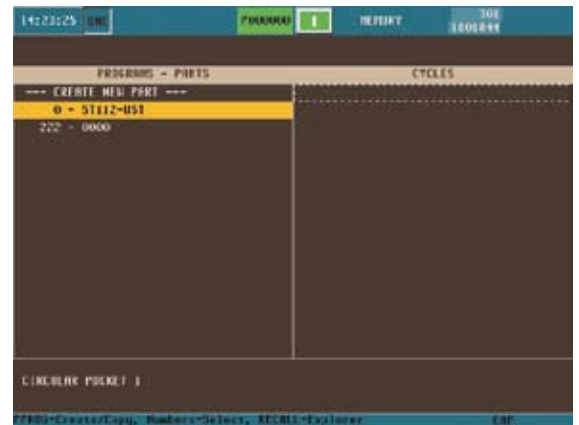

Execute or simulate a single cycle

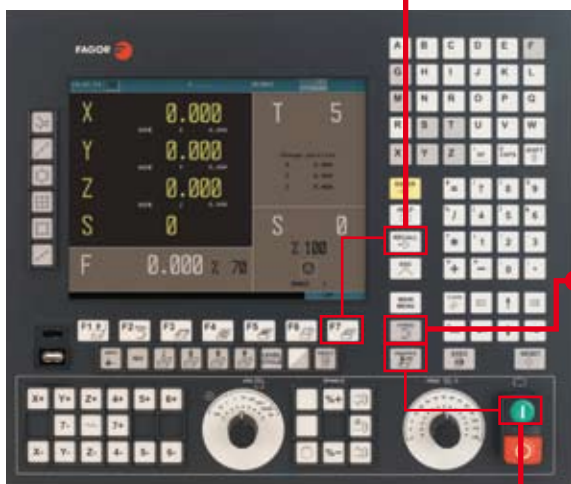
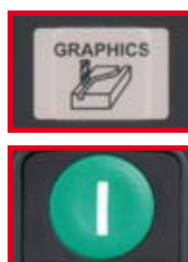

Preparation help

tool management

Tools are managed before and during machining through simple intuitive operations that make the operator's job easier.

Calibrations

For proper machining, the CNC has to know the dimensions of the tools. Fagor Automation offers several options for setting them:

- After pre-setting of the machine, you may automatically enter that data into the CNC offset positions.
- Using a master part with a known dimension or position. Simply touch off the tool on the part and the CNC will automatically calculate and load the offset thus the CNC now assumes the real part position of the tool.
- Automatically using a touch probe. By integrating automatic tool calibration cycles into the part-program, up time is increased, idle time is greatly decreased.

Corrective actions

While using the tools, the user can take different corrective actions:

- Compensate for tool wear. Fagor Automation offers the possibility to make this correction either manually or automatically using the cycles developed specifically for this purpose.
- Verify tool status. The operator can interrupt the execution of the machining operation when detecting tool problems to replace it with another one or the same or a different tool from the previously active tool.
- Define tool life. Thanks to tool monitoring, the CNC automatically checks when the tool has finished its useful life (Set by the user) or not and will replace with a similar one. This feature is very useful in production machining operations or on repetitive processes so as not to interrupt the machine.

Manual calibration



Automatic calibration



Corrective actions



part preparation

In serialized part production, in order to obtain repeatability in the positioning process of the new parts, the 8055 CNC helps the user run these operations fast, accurately and efficiently.

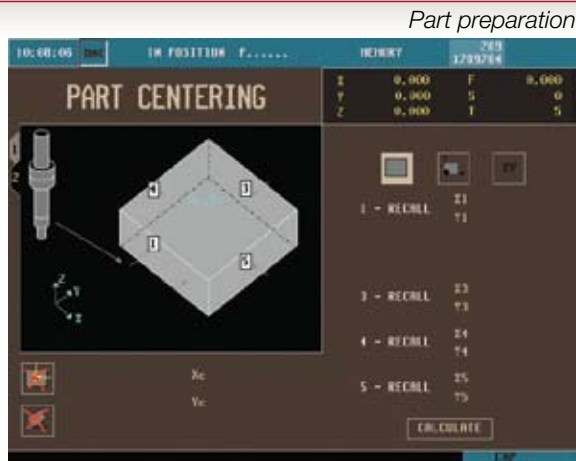

Part preparation

Fagor Automation offers measuring cycles that help the user detect the exact position of the part on the work table. The 8055 CNC provides data such as corner positioning, center coordinates, part angle rotation, etc...

Due to this data, the CNC has the ability to adapt the work coordinates to the actual part position, thus avoiding to move the part until the correct position is reached.

Fagor Automation's measuring cycles may be used as the following:

- Manually guided by the CNC. When not using a part measuring probe on the machine, the user only has to approach the tool to the part manually and validate the contact points
- Automatically. If the machine uses a touch probe, all of the operations are then run automatically and managed by the Fagor cycles.

Zero offsets

ZERO OFFSET TABLE

PLC	X	Y	Z
001	0.0000	0.0000	0.0000
054	0.0000	0.0000	0.0000
055	17.8322	10.5052	3.4250
056	28.9918	28.0685	3.4250
057	0.0000	0.0000	0.0000
058	0.0000	0.0000	0.0000
059	0.0000	0.0000	0.0000
G1597	0.0000	0.0000	0.0000
G1598	0.0000	0.0000	0.0000

Buttons: Edit, Modify, Find, Delete, Load, Save, Back

Zero offsets

With the 8055 CNC, it is possible to define several reference points on the machine and save them in memory to be used later on. In later machining operations, the user can recover these reference points without having to calculate them again, therefore avoiding possible errors.

Part damage prevention

The canned cycles offer additional safety while machining. If the in-correct tool has been selected for a particular machining operation, the CNC will interrupt the execution to prevent any damage to the part or machine. However if the correct tool has been selected, but the positions are not correct for the machining operation being executed, the CNC will run all the possible passes without jeopardizing the final shape of the part and will warn the operator that the operation was in-complete because the wrong tool was utilized.

Programming

ISO-coded language / ICON conversational language

Fagor Automation offers various programming languages to allow for improved operator ease & efficiency.

Programming in cycles

These programming languages may be combined when creating part-programs.

ISO-coded language for large production runs where optimizing the program is more important considering cycle time reduction is an important aspect of the operation.

ICON conversational language for small part-runs. This intuitive interface has been conceived for shops where set-up & programming time is a critical factor. One of the advantages of working with **conversational cycles** is that besides simplified programming, it offers a safe working method.

Programming in ISO requires taking into account all movements, including those above and around the part plus machining passes, tools, axis feed rates, spindle speed, etc., Which increases the possibility of making critical mistakes that could cause personal injury or damage to the machine. The conversational mode of the 8055 CNC automatically takes into consideration these factors, hence helping to prevent critical mistakes & risks.

The 8055 CNC offers a **wide range of cycles** that cover most of the operations that an operator may need. For complex parts, Fagor Automation CNC's can **import those CAD-generated files**. Imported files may be used inside the conversational cycles. The CNC can then manage all the tool paths needed to produce the part.

File encryption

With this function, the OEM can encrypt his files once the machine set-up is completed in order to protect his source file. Hence eliminating any misuse by any other sources: the user when attempting to download the data to a PC, will only see illegible text.

ICON conversational language



ISO-coded language

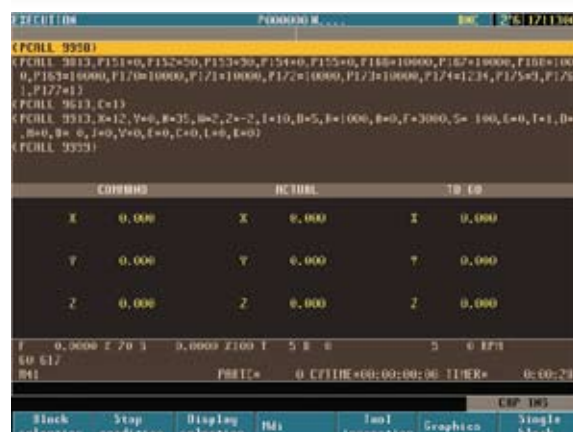

Importing CA-generated files

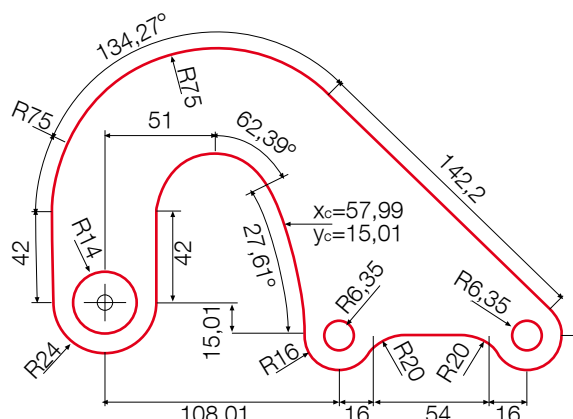

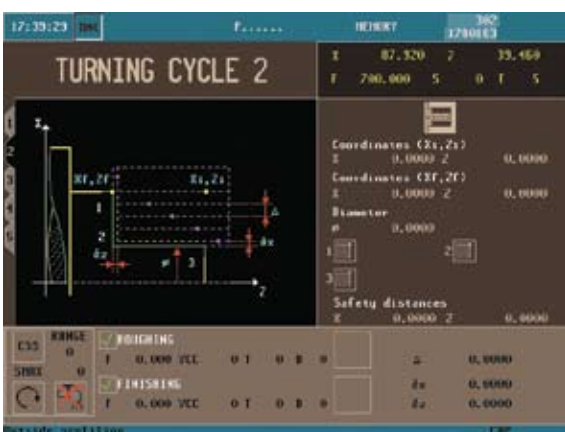
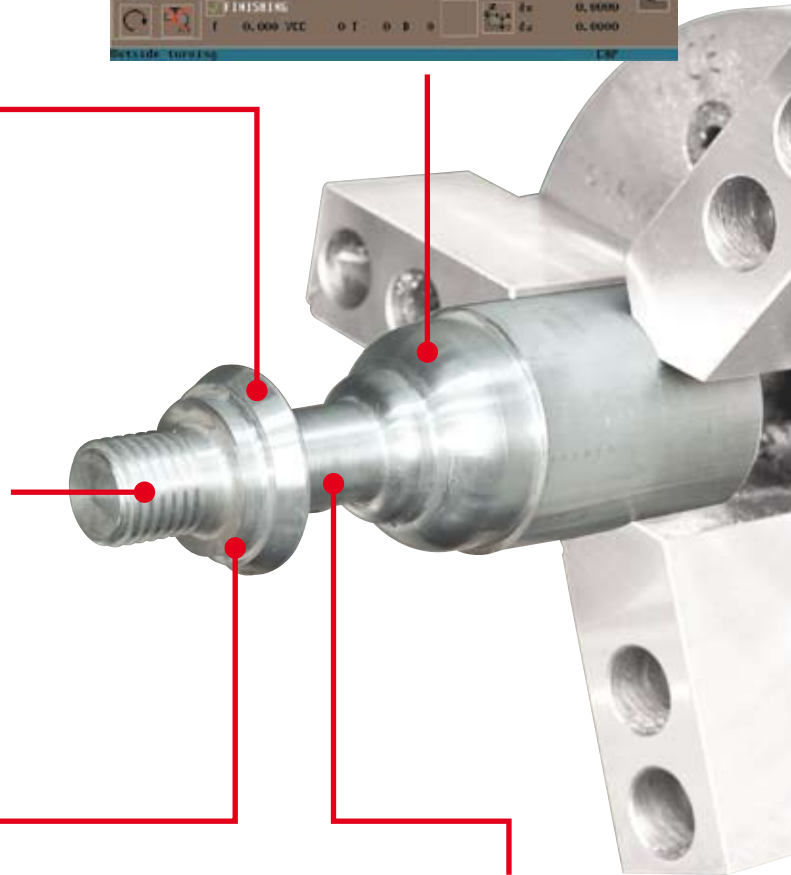
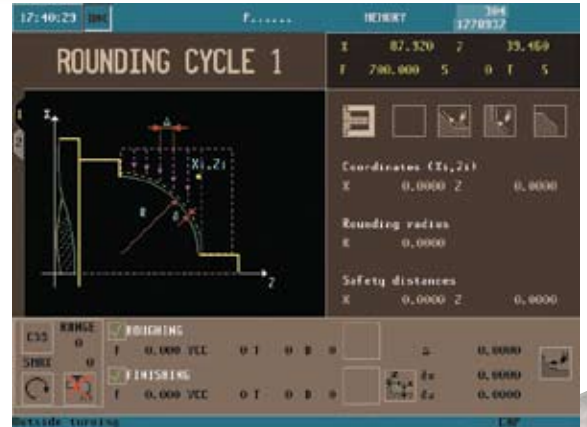
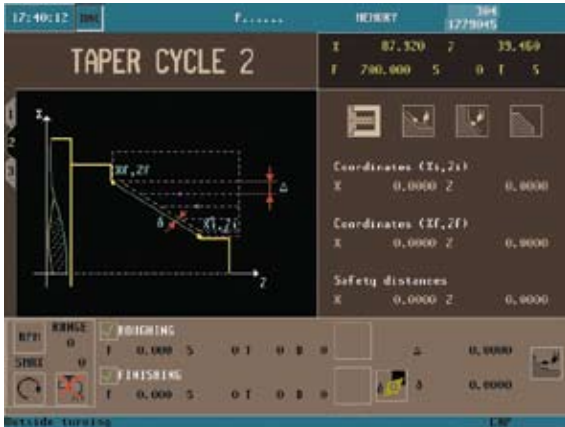

Integral solution

with our product range

Spindle Motors

Fagor Automation offers a wide range of motors for a broad range of application requirements.

Small compact motors balance for high speed starting at 3.7 kW and expanded to large machine, high power applications up to 130 kW. Designed for low noise & vibration levels all the way up to 15,000 rpm.

Offered as an option, motors with dual winding (Y/Delta, star/triangle) and direct drive with a built-in hold in the shaft for automated tool cooling. (Coolant through the Spindle feature).

Axes motors range from 3000 rpm to 6000 rpm and a stall torque from 1.7 NM up to 115 Nm

Servo Drive Systems

The Fagor Automation's digital servo drive system is the perfect solution for the machine tool manufacturer who demand high performance machining.

Fagor Automation drives are designed to obtain maximum efficiency from their motors thus offering a true high performance solution for both spindle and axis control.

Feedback Systems

Fagor Automation offers complete range of Absolute, Coded and Incremental optical linear and rotary encoders for increasing machining accuracy and performance.

The encoder sends the real position data of the machine movement to the CNC, and hence minimizing errors due to thermal behavior of the machine, ball screw and other mechanical errors.

Fagor Automation offers incremental and absolute solutions according to the requirements of the machine with measuring lengths between 0.070 m and 60 m, and 0.1 μm resolution and 3 μm accuracy. These solutions utilize TDMS[®] (Thermally determined mounting system) that prevents measuring errors due to temperature changes and have the ability to work at feed rates up to 120 m/minute.

Remote CAN I/O modules

These modules are easy to install and can be mounted at strategic points of the machine, thus having extra logic inputs and outputs distributed next to the devices. Using these modules makes it easier to lay out the elements of the electrical cabinet and therefore translates into reduced costs due to fewer cable/wiring being utilized. The modules are distributed in groups and are connected to the central unit through the digital CAN Bus.

Connectivity

The 8055 CNC offers these communication buses: Ethernet, USB or serial line. It is ready to be connected within the company network and may be managed remotely. Maintenance is possible by using tele-diagnosis through an external modem, thus allowing for instant service support via cyberspace.

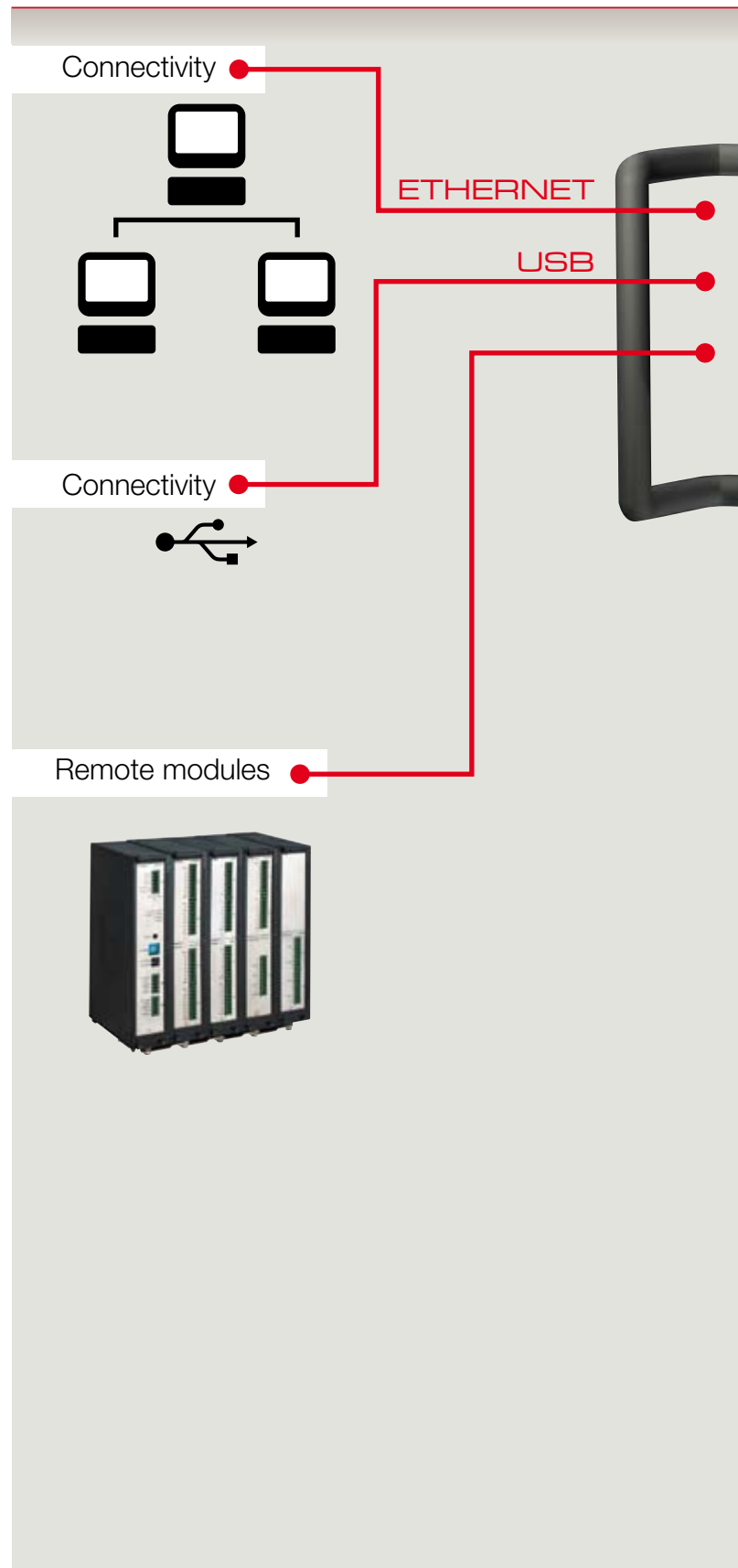

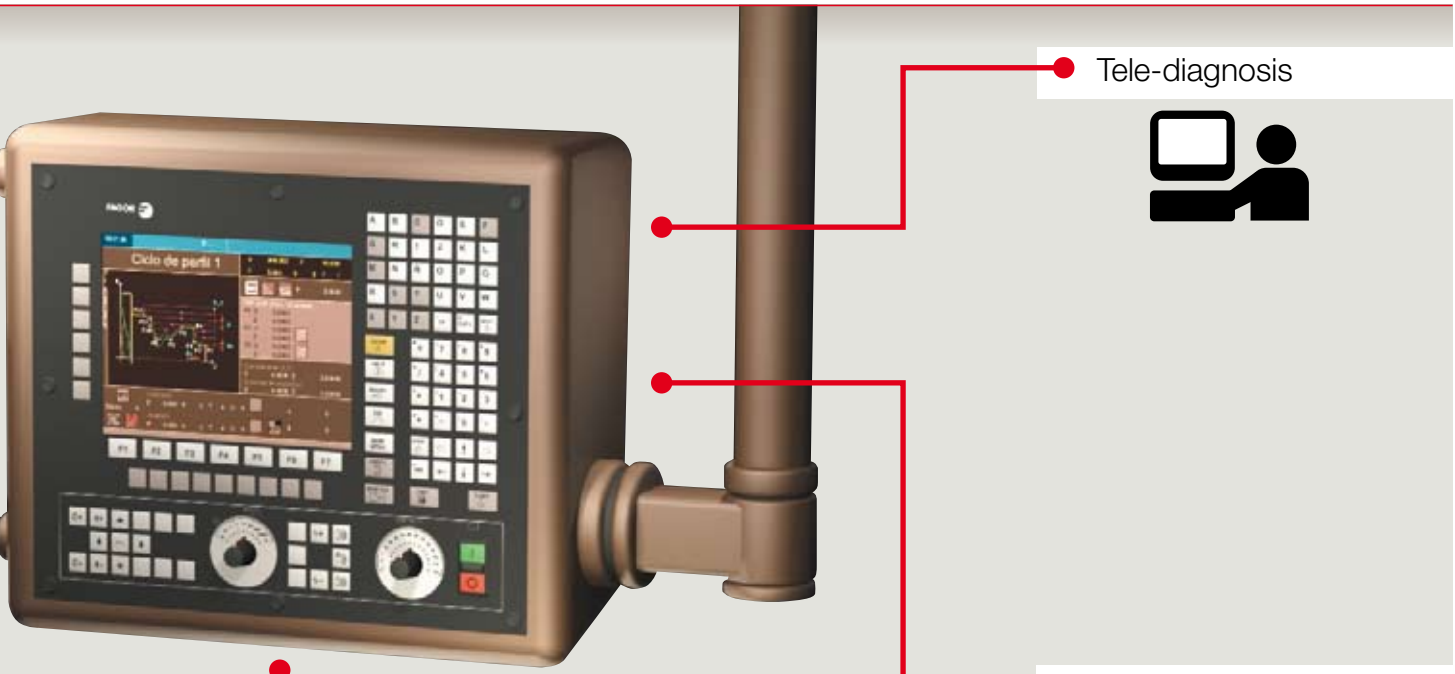

Tele-diagnosis



Feedback Systems

COMMUNICATION
DIGITAL/ANALOG

Servo Drive Systems



Motoring

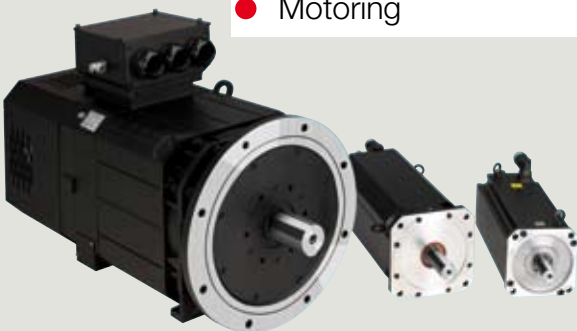

Technical specifications

CNC 8055 FL			CNC 8055 POWER		
Lathe	Mill	GP	Lathe	Mill	GP

System configuration

Basic axis configuration	2	4	4	2	4	4
Maximum axis configuration	4	4	4	7	7	7
Maximum spindle configuration	2	2	2	2	2	2
Maximum axis/spindle configuration	5	5	5	8	8	8
User memory (RAM)	1 MB	1 MB	1 MB	1 MB	1 MB	1 MB
User memory (Compact Flash)	512 MB 2 GB ♦	512 MB 2 GB ♦	512 MB 2 GB ♦	512 MB 2 GB ♦	512 MB 2 GB ♦	512 MB 2 GB ♦
Block processing time	3.5 ms	3.5 ms	3.5 ms	1 ms	1 ms	1 ms
Maximum local digital I/O (Modular model)	232/120	232/120	232/120	232/120	232/120	232/120
Maximum local digital I/O (Integrated model)	56/32	56/32	56/32	56/32	56/32	56/32
Maximum remote digital I/O (Integrated only)	288/192	288/192	288/192	288/192	288/192	288/192
Sercos digital servo system	Optional	Optional	Optional	Optional	Optional	Optional
CAN digital servo system	Optional	Optional	Optional	Optional	Optional	Optional
Analog servo system	Standard	Standard	Standard	Standard	Standard	Standard
Maximum analog axis configuration (Modular model)	8	8	8	8	8	8
Maximum analog axis configuration (integrated model)	5	5	5	5	5	5

General purpose features

Advanced Block Look Ahead	100	100	100	200	200	200
Maximum number of tools	255	255	255	255	255	255
Maximum number of tool offsets	255	255	255	255	255	255
Tool life monitoring	Optional	Optional	-	Optional	Optional	-
Ethernet Capability	Optional	Optional	Optional	Optional	Optional	Optional
USB	Standard	Standard	Standard	Standard	Standard	Standard
Tele-diagnosis	Optional	Optional	Optional	Optional	Optional	Optional
Setup assistance	Standard	Standard	Standard	Standard	Standard	Standard
Bidirectional leadscrew compensation	Standard	Standard	Standard	Standard	Standard	Standard
Cross compensation	Standard	Standard	Standard	Standard	Standard	Standard
Work in non-orthogonal planes	Standard	Standard	Standard	Standard	Standard	Standard
Supported languages	13 (*)	13 (*)	13 (*)	13 (*)	13 (*)	13 (*)
Customizable interface	Standard	Standard	Standard	Standard	Standard	Standard
Spindle kinematics management	-	-	-	-	Optional	-
Table kinematics management	-	-	-	-	Optional	-
Work in inclined planes	-	-	-	-	Optional	-
Gantry axes	Standard	Standard	Standard	Standard	Standard	Standard
Contour Control (JOG mode)	Standard	Standard	Standard	Standard	Standard	Standard
Feed handwheel	Standard	Standard	Standard	Standard	Standard	Standard

♦ Optional

(*) English, Spanish, French, Italian, German, Dutch, Portuguese, Czech, Polish, Mainland Chinese, Basque, Russian, Turkish.

CNC 8055 FL			CNC 8055 POWER		
Lathe	Mill	GP	Lathe	Mill	GP

Programming and operation

Retrace function	Optional	Optional	-	Optional	Optional	Optional
Collision detection function	Standard	Standard	Standard	Standard	Standard	Standard
Simulation with execution time estimate	Standard	Standard	Standard	Standard	Standard	Standard
Graphics with tool path lines	Standard	Standard	Standard	Standard	Standard	Standard
Solid graphics	Standard	Standard	-	Standard	Standard	-
Graphics for vertical lathe	Standard	-	-	Standard	-	-
Conversational	Optional	Optional	-	Optional	Optional	-
Profile editor (Minicad)	Standard	Standard	Standard	Standard	Standard	Standard
Machining canned cycles	Standard	Standard	(**)	Standard	Standard	(**)
Probing canned cycles	Optional	Optional	-	Optional	Optional	-
Spindle synchronization	Standard	-	-	Standard	-	-
C axis	-	-	-	Optional	-	-
Electronic and variable pitch threading	Standard	-	-	Standard	-	-
High speed machining algorithms	Standard	Standard	Standard	Standard	Standard	Standard
Interruption subroutines	Standard	Standard	Standard	Standard	Standard	Standard
Movement against hard stop	Standard	Standard	Standard	Standard	Standard	Standard
Feedrate as inverted function of time	Standard	Standard	Standard	Standard	Standard	Standard
Scaling factor applied to one or more axes	Standard	Standard	Standard	Standard	Standard	Standard
Pattern rotation (coordinate system rotation)	Standard	Standard	Standard	Standard	Standard	Standard

(**) Only drilling and rigid tapping cycles



FAGOR AUTOMATION

Fagor Automation, S. Coop.

Bº San Andrés, 19
 E-20500 Arrasate - Mondragón
 Tel. : +34 943 719 200
 Fax. : +34 943 791 712
 E-mail : info@fagorautomation.es



Fagor Automation holds the ISO 9001 Quality System Certificate and the CE Certificate for all products manufactured.

www.fagorautomation.com

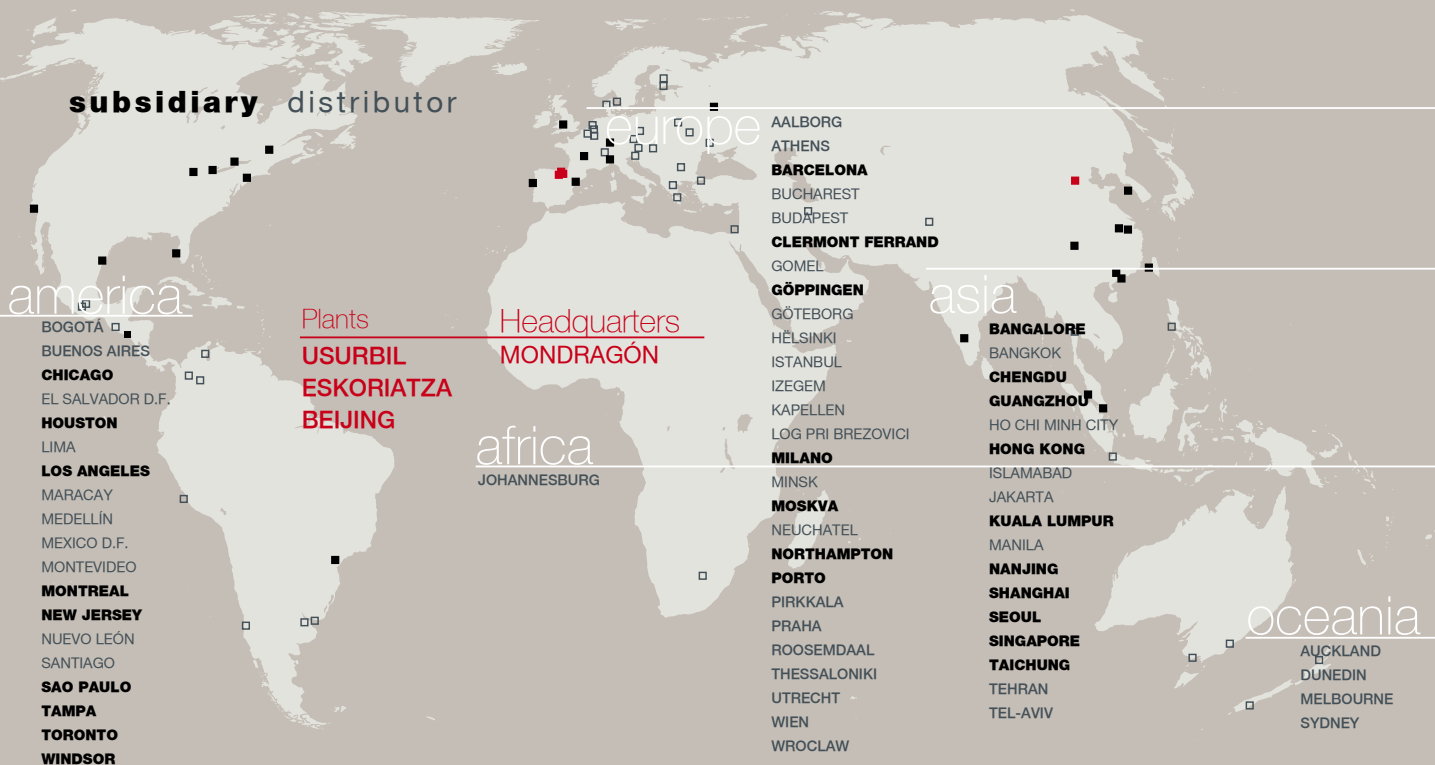

worldwide automation