

Universal Enclosure

Owners Manual



- The universal enclosure assembly requires two adults.
- Please check the net prior to each use.
- This universal enclosure cannot be used when your trampoline socket or the diameter of the leg is more than 1.5 inch

1, Lay upper tube(2) and lower tube(12) on the ground as shown, insert one end of lower tube into upper tube with screw(13)

Assembly 1

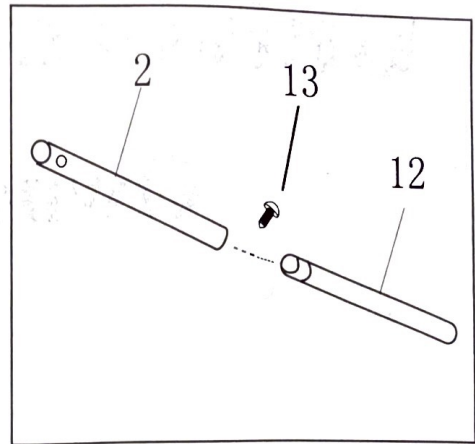

2, Insert the tube into the sleeve as shown, if there is no sleeve for your trampoline, please go to assembly 3 directly

Assembly 2

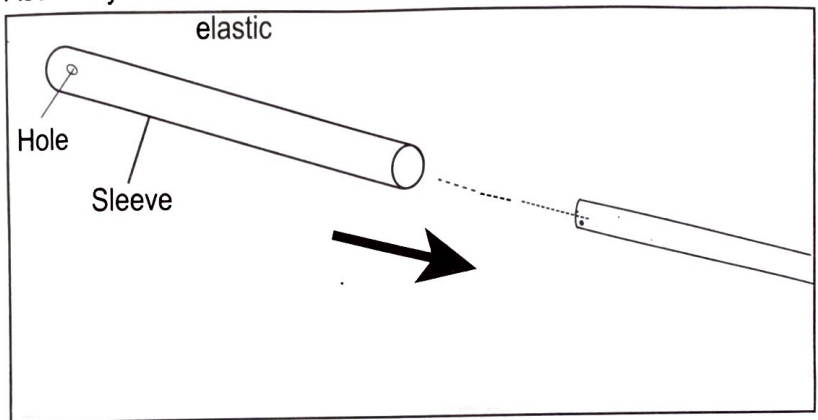

3, There is a Hexagon hole on the pole cap (1) with a locknut(10) inside as shown A. Insert the pole cap(1) through enclosure strap as shown in B, then insert the tube into pole cap with bolt as shown C

Insert the Thumbscrew (14) so that it passes through the grommet of the sleeve, then the grommet of the strap, then the pole cap, then the enclosure pole and screw it into the nut that is held in the hexagon on the back of the pole cap

Assembly 3

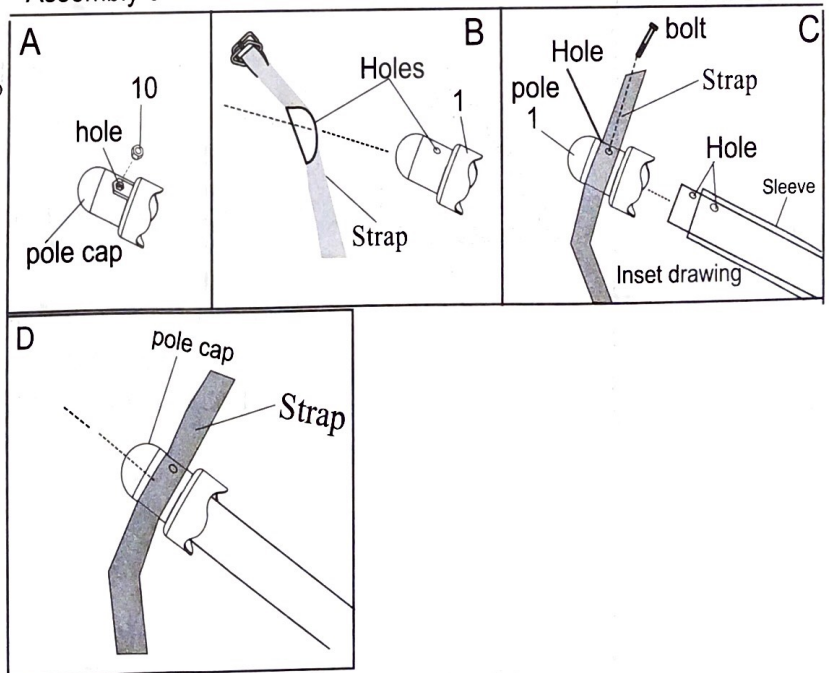

Assembly 4

4. Locate the left leg on one of the leg sections of the trampoline. Hold a U-bolt (5) around the left leg, slide a U-bolt Bracket (4) onto the U-bolt, and then thread two Nylon Locknuts (3) two turns onto the U-bolt. Slide the U-bolt to the bottom of the left leg. Attach another U-bolt and U-bolt Bracket to the left leg in the same way. Repeat this step with the left legs on the other leg sections (not shown).

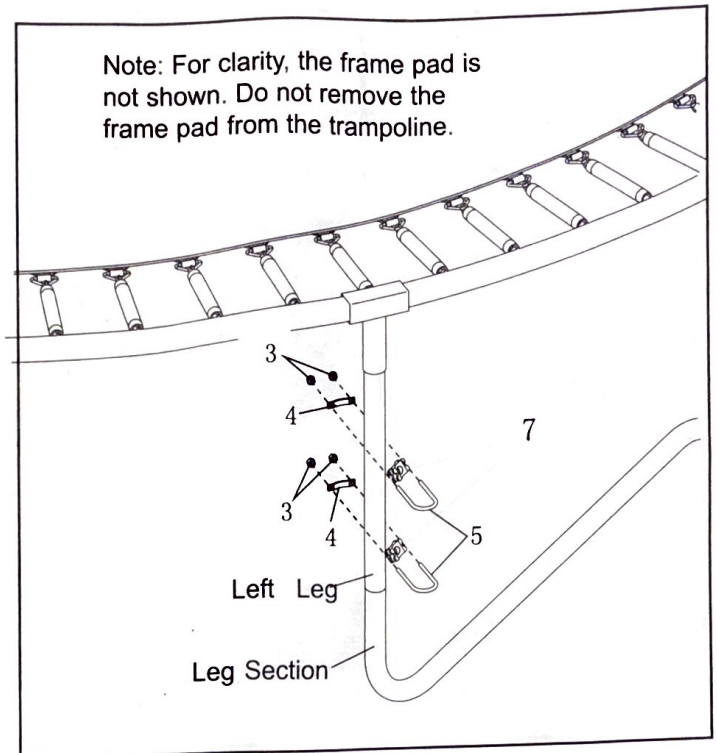

5.

Identify the end of a lower Tube (12), Using a marker and a measuring tape, draw a mark 15" from the lower end of the Straight Tube.

hold the Straight Tube against the left leg on one of the leg sections, and align the mark that you drew with the top of the indicated socket.

Next, slide one of the U-bolts(5) up until it touches the bottom of the socket, and tighten the two Nylon Locknuts (3) on the U-bolt. Slide the other U-bolt up until it is 2" above the lower end of the Straight Tube and 8" below the the first U-Bolt(5) then tighten the two Nylon Locknuts on the U-bolt. Then, press two Plastic Caps (16) onto each U-bolt.

Repeat this step to attach the other Straight Tubes to the left legs on the oth leg sections (not shown).

Assembly 5

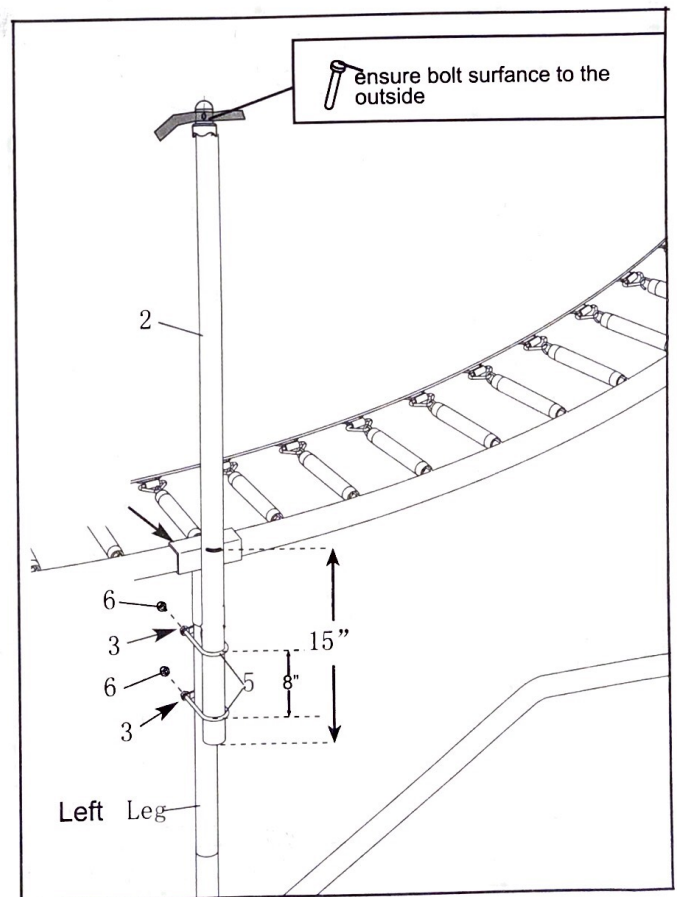

Assembly 6

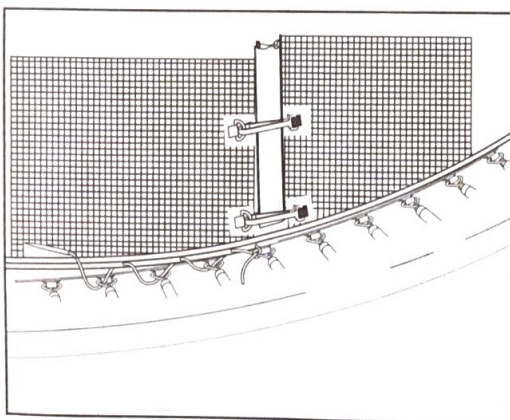
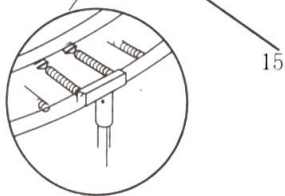
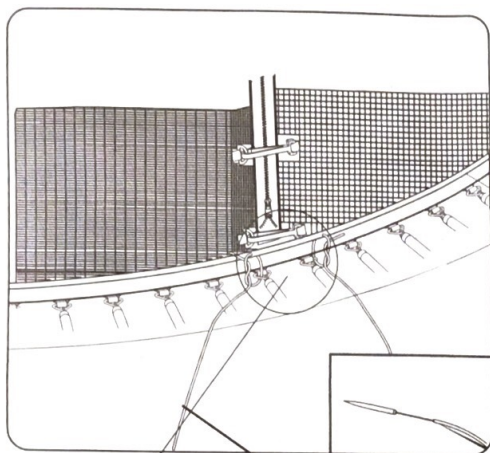
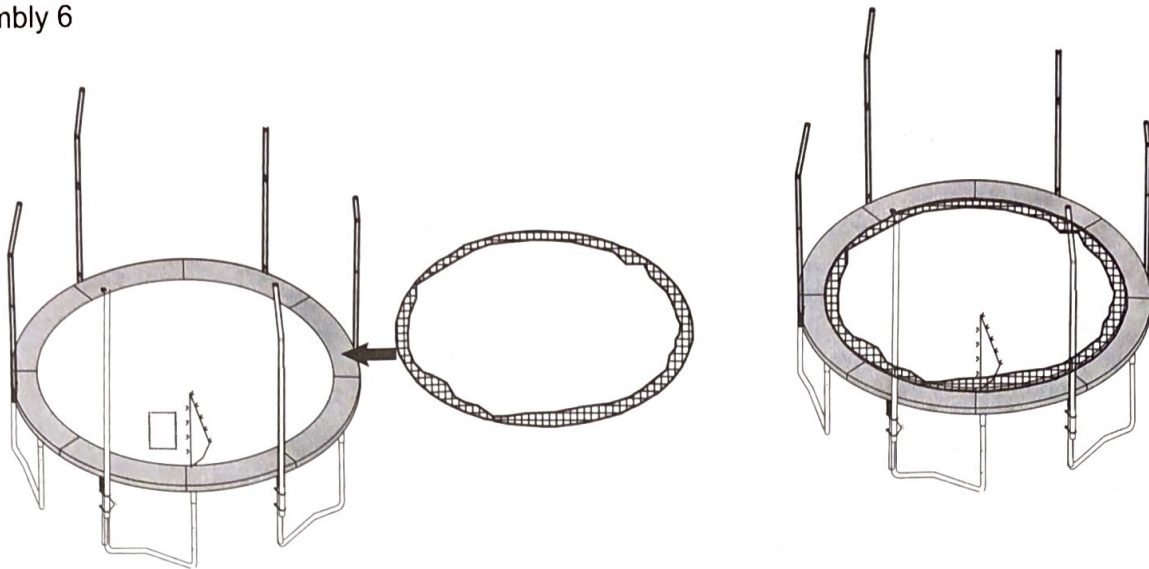

6. Lay the enclosure mesh (8) on the trampoline, as shown. First, ensure the enclosure door is located in the middle of any two upright tubes. Start by threading the cord through the first hole located to the bottom of the right zipper of the net. Once through the first net hole, thread the cord through the closest mat ring. After threaded through both the mesh hole and mat ring, securely attach the cord to the net and mat by tying a knot around them.

Continue on by threading the cord through the next net hole and mat ring until all holes and rings have been threaded. Keep in mind, when moving show a close up of the stiched net

from one hole and ring to another hole and ring be sure to properly tighten the cord as you go along,

doing so will keep a correct tension throughout. When done threading the cord through all net holes and mat rings tie another knot to secure the cord to the last hole and ring.

WARNING: Failing to securely attach the cord to the net and mat can lead to serious injury. Be sure to tighten the cord as you move along threading the cord through each net hole and mat ring.

7, After stitching the net to the complete circumference of the jumping surface, please lift the net up then prepare to attach the straps to the poles ,the assembly step as shown(D)

There are multiple holes on the net, attach the straps through the hole of the net which gives the best fit

Assembly 7

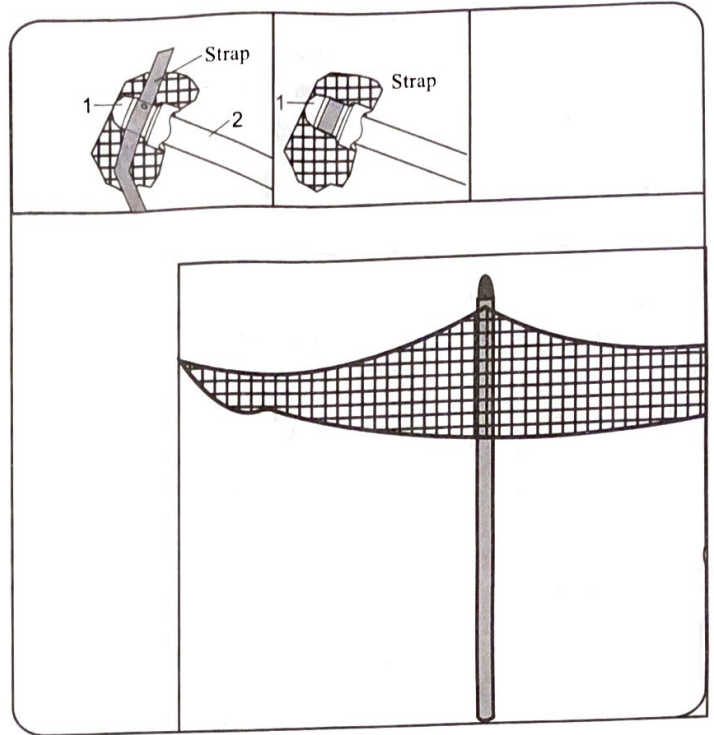
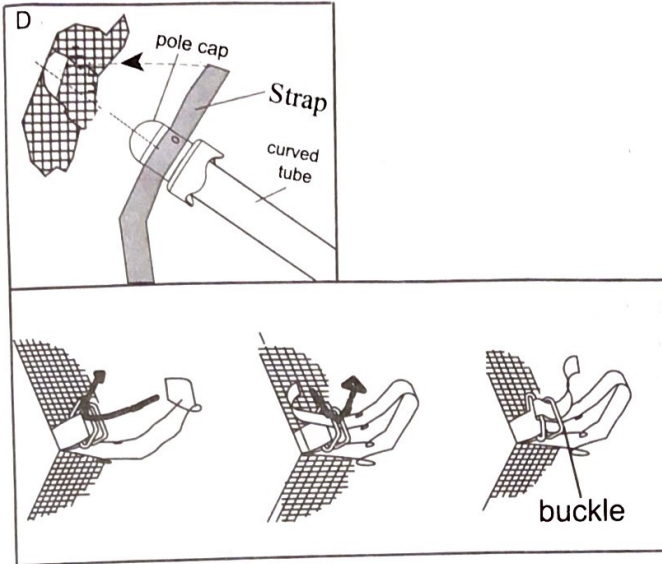

Your Universal enclosure is now fully assembled. make sure the net not only too tighten but also too loose by adjusting the buckle(only shown 6 poles)

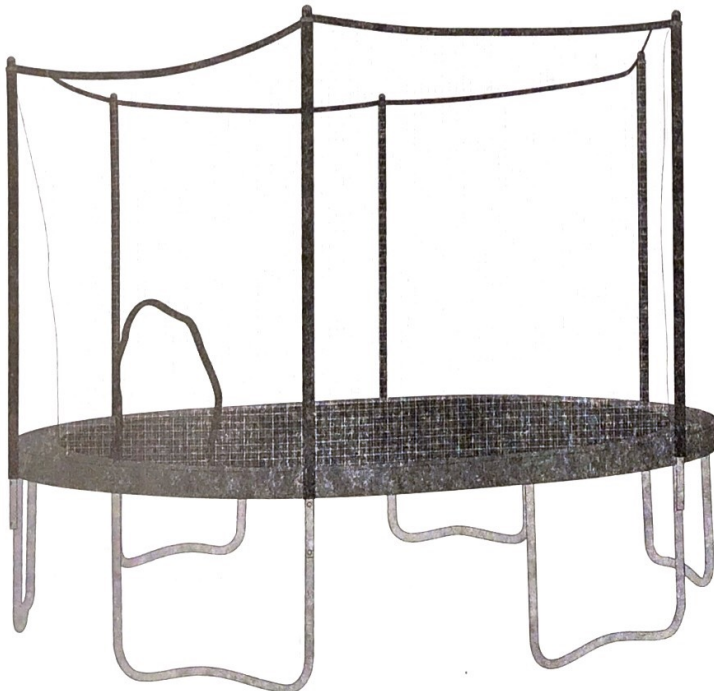

PARTS LIST (The trampoline with 6 poles)

Key No.	Qty.	Description	Key No.	Qty.	Description
1	6	Pole cap	10	6	M5 Locknut
2	6	Upper tube	11	6	Strap
3	24	M8-Nylon Locknuts	12	6	Lower tube
4	12	U-bolt Bracket	13	7	Screw(1 spare)
5	12	U-bolt	14	6	Bolt
6	1	Tool	15	6	Cord(12 ft enclosure)
7	12	Spacer		8	Cord(14 ft enclosure)
8	1	Mesh		9	Cord(15 ft enclosure)
9	6	Sleeve(selectable)			



Pole cap



strap



Sleeve



M5 Locknut



U-bolt



U-bolt Bracket



Spacer



Lower tube

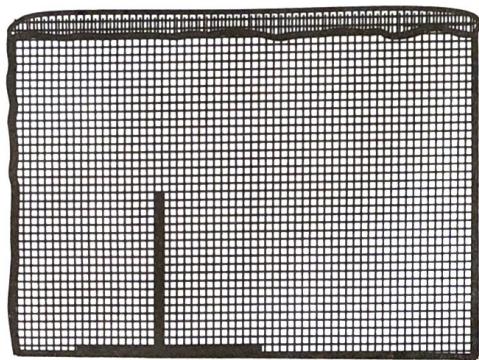

Net

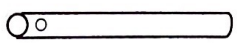

Upper tube



Nylon Locknuts



screw



Bolt



tool



cord

PARTS LIST (The trampoline with 8 poles)

Key No.	Qty.	Description
1	8	Pole cap
2	8	Upper tube
3	32	M8-Nylon Locknuts
4	16	U-bolt Bracket
5	16	U-bolt
6	1	Tool
7	16	Spacer
8	1	Mesh
9	8	Sleeve(selectable)

Key No.	Qty.	Description
10	8	M5 Locknut
11	8	Strap
12	8	Lower tube
13	9	Screw(1 spare)
14	8	Bolt
15	6	Cord(12 ft enclosure)
	8	Cord(14 ft enclosure)
	9	Cord(15 ft enclosure)

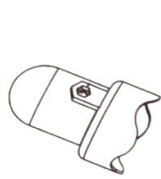

Pole cap



strap

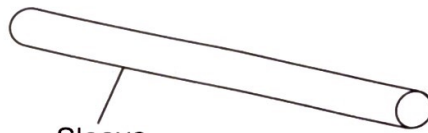

Sleeve



M5 Locknut



U-bolt



U-bolt Bracket



Spacer

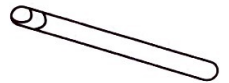

Lower tube

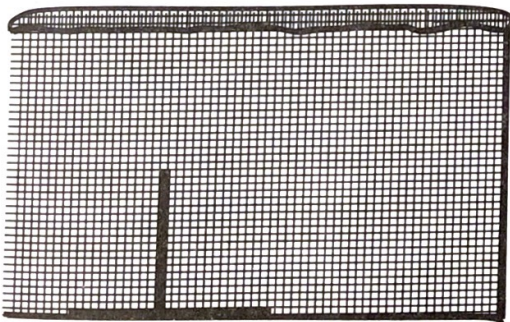

Net

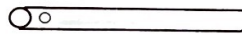

Upper tube



M8-Nylon Locknuts



screw



Bolt



tool



cord