

Cell Type CR-1/3N Specifications

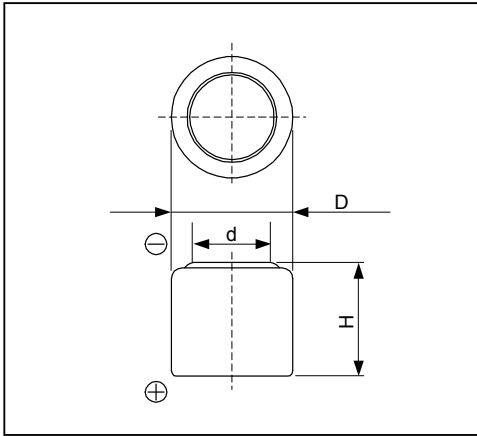

Nominal Voltage (V)	3	
Nominal Capacity (mAh) ^{*1}	160	
Standard Discharge Current (mA)	2	
Max. Discharge Current (mA)	Continuous ^{*2}	60
	Pulse ^{*3}	80
Temperature Range (°C)	-40 ~ +60	
Weight (g)	3.3	
Dimensions (mm)	D	11.6
	H	10.8
	d	7.8

*1 Nominal capacity is determined to an end voltage of 2.0V when the battery is allowed to discharge at a standard current level at 23°C.

*2 Current value is determined to be the level at which 50% of the nominal capacity is obtained with an end voltage of 2.0V at 23°C.

*3 Current value for obtaining 2.0V cell voltage when pulse is applied for 15seconds at 50% discharge depth at 23°C.

Typical Characteristics

Discharge Characteristics of CR1/3N

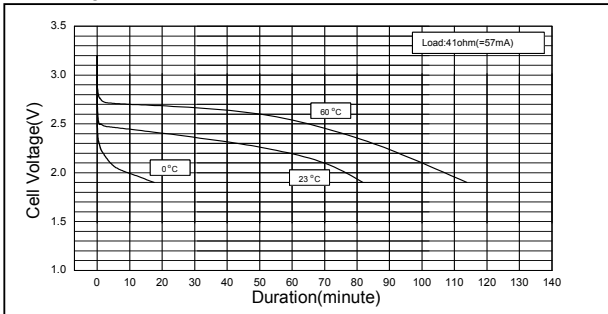

Discharge Characteristics of CR1/3N

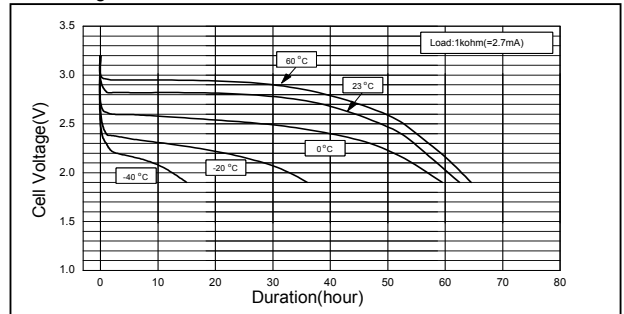

Discharge Characteristics of CR1/3N

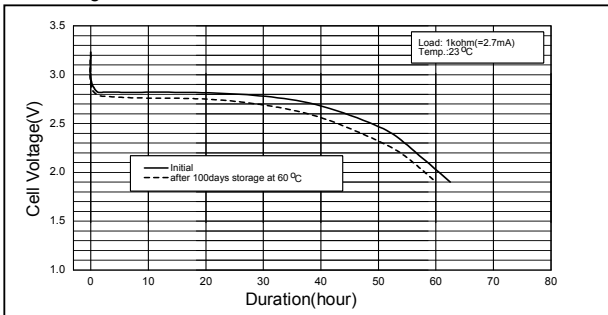

Discharge Load vs. Capacity of CR1/3N

