

reacha®



Operating instructions



Scan me and visit the
video tutorial!

<https://bit.ly/reacha-en-manual>



We are very pleased that you have chosen a handcart and bicycle trailer from **reacha.de**. We have carefully designed our frame made in Bavaria as well as the other parts of our products in order to ensure the best possible handling and a long service life. Please read the following operating instructions carefully before using the product for the first time, so that you can enjoy it for a long time without endangering yourself and others while using it.

If you are using the trailer on the road, please note that the legal regulations regarding the use of bikes and bike trailers are different in every country. Please comply with the laws and be thoughtful of the others on the road.

Have fun with your reacha,

Your reacha Team

CONTENT	PAGE
1. Description	04
2. Before the first use	06
3. Unpacking and initial assembly	10
4. Transport and storage	22
5. Accessories	25
6. Road traffic licensing regulations	32
7. Maintenance, care and disposal	33
8. Technical specifications	34
9. Guarantee and warranty	35
10. Imprint	36



NO PASSENGER TRANSPORT

reacha cargo trailers are not designed or approved for passenger transport, especially not for children!

DESCRIPTION

DESCRIPTION

These operating instructions refer to products and accessories of the "reacha" series, with the following product packages: reacha DIY, reacha CITY, reacha SPORT, reacha XL and reacha PRO.

Components

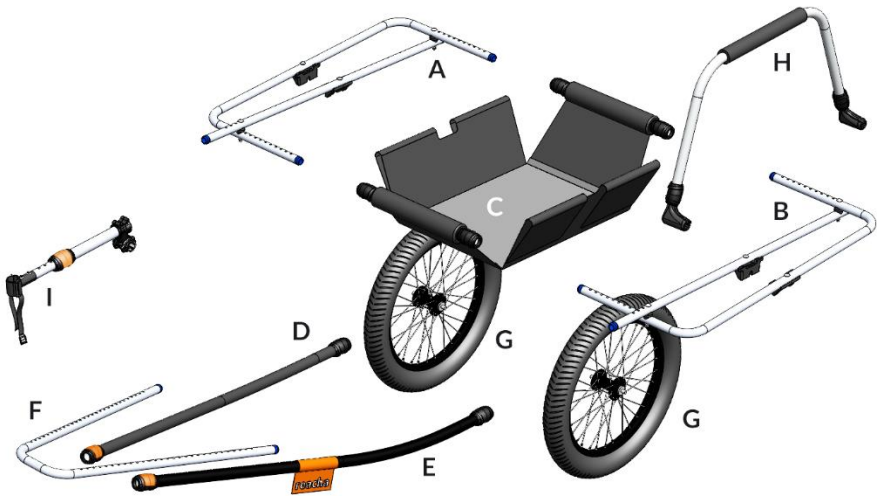

A	Mainframe - Wheel frame right	F	Tow bar extension
B	Mainframe - Wheel frame left	G	Wheels, 2 each
C	Trunk (=textile platform) with two connecting pipes	H	Bow
D	Tow bar - right	I	Bike-Connector
E	Tow bar - left		

Intended Use

Reacha is a cargo trailer for manual operation. It can also be used as a bike trailer with the optional bike connector.

According to these instructions, all packages are intended to be as a hand-trailer or optional as a bike trailer during the day on paved roads for transporting loads.

The product package *reacha beach 20"* and *reacha Pro* can also be used on slightly unpaved roads and on sand. Carriage of animals may only be done with a sufficiently secure storage container provided for the transport of animals.

	bike trailer	hand trailer
Maximum weight allowed (Trailer + cargo)	45 kg	65 kg
Maximum cargo load (cargo)	35 kg	60 kg
Support load on the spar	1 bis 7,5 kg	n.d.

While using it as a bike trailer in poor visibility, at dusk or at night, the correct lighting must be retrofitted according to the laws and regulations of the country, in which it is used.

Not for use in...

Any use not listed above is prohibited and is to be done at your own risk. This includes in particular the use for the transport of persons. Commercial use, overloading, excessive speeds (higher than 20 km/h), improper defect rectification and use on unpaved roads (with the exception of *reacha beach 20* and *reacha PRO*) are not permitted.

Reacha must not be used as trailers for motorized vehicles such as mopeds and motorcycles. Use with electric bikes is only permitted with pedelecs with pedal-assistance (max 25 km/h)

The liability of good goods tegernsee GmbH for damages resulting from non-compliance of these specifications is excluded.

BEFORE THE FIRST USE

Symbols and warnings



WARNING !

This symbol indicates a potential hazard to your life or health, if the appropriate instructions are not followed or if proper precautions are not taken.



CAUTION!

This symbol indicates imminent damage to the product or the environment, if appropriate action is not followed as instructed.

NOTE

This symbol gives information about the handling of the product or parts of the operating instructions, which need to be specifically pointed out.

Risk of pinch

There is a risk of fingers and hands getting caught in the moving parts and the snap-locks while assembling and disassembling the trailer.

Loading and unloading

Do not ever transport unsecured cargo. Make sure that the cargo does not come into contact with the wheels; there is a risk of your cargo getting damaged through the friction of the wheels.

Ensure an even weight distribution during loading and unloading. Too much load on the spar burdens the spar and possibly even the bike connector too much. Too much weight on the back side shifts the centre of gravity to the rear and there is a risk of tipping over. Also make sure

not to over-load the trailer, because the risk of tipping over gets greater, the heavier you load the trailer.

Before every ride

Check the following before every ride:

- Properly fit wheels
- Correct tire pressure of the wheels (see tire manufacturer's information)
- All snap-locks firmly locked
- Correct securing of the cargo
- If applicable, secure attachment of the bike connector to the lead-bike
- If applicable, proper functioning of the brakes of the lead-bike

Requirements for the cyclist

Inform yourself about the legal regulations of the country or the region, in which you want to use the reacha. Reacha is an un-braked trailer. The lighter the bike and the driver, the higher the risk that the loaded reacha will cause the rear wheel of the bike to burst.

Children under the age of 16 are not allowed to use a bike trailer.

Requirements for the lead bike

The lead bike must be approved for use with cargo trailers by the manufacturer. Moreover, it must be in a technically perfect state and correspond with the state of the art. Ensure that the brakes of the bike are working perfectly before each ride.

General correct way of driving

Drive on curbs and bumps with minimal speed. There is an increased risk of tipping-over especially with the unloaded trailer. If the trailer tips over, it can lead to accidents with life-threatening consequences.

Never drive on stairs or escalators with your trailer.

Correct way of driving as a bike trailer

If you are going to use the reacha as a bike trailer, slowly get used to its handling and dimensions, initially without any load on the trailer and on quiet roads.

The braking distance of your bike-trailer combination is extended in wet conditions.

Drive on curves at walking speed. Especially while using Pedelecs one often underestimates the speed. While driving on curves at too high speeds, the trailer may get tossed and turned due to the centrifugal force, overturn and even knock the bike over. This can lead to life-threatening injuries and damage the trailer and bike.

Reduce your speed on slopes. If the speed is too high, the trailer may start to spin, which can lead to accidents with life-threatening consequences.

Let the brakes of your bike cool down during longer runs.

Please ensure that other users of the trailer too read the operating instructions carefully beforehand.

Use, storage and transport

The reacha models may only be transported inside motor vehicles, even when disassembled.

Do not use the reacha at temperatures below -20 degrees Celsius and do not keep it outside at such temperatures.

When storing, ensure that all parts, especially the textile, are dry and protected from moisture. Otherwise there is a danger of mould formation.

Assembly, maintenance and servicing

The reacha may only be used in a technically perfect state. Check the reacha regularly for damage to wheels, frame parts, textile trunk and wherever applicable, bike connector. Damages must be corrected

properly before use; otherwise it can lead to life-threatening accidents and injuries.

The reacha must be assembled properly. Follow the instructions for proper frame assembly, spar assembly, wheel assembly, and assembly of accessories. If you have questions or doubts, you can always contact us at hello@reacha.de. Incorrect assembly can lead to accidents with life-threatening consequences.

Changes and modifications

The reacha must not be modified or altered. Extensions are also impermissible.

The use of the reacha with wheels other than the supplied ones is permitted, only if they meet the requirements for use with reacha (see page 15).

Other modifications and changes may lead to accidents with life-threatening injuries. They also invalidate the warranty. Good goods tegernsee GmbH does not assume the liability for damages caused by them.

UNPACKING AND INITIAL ASSEMBLY



WARNING !

The reacha must be assembled properly; otherwise there is a risk of accidents involving life-threatening injuries.



WARNING !

Please exercise caution with the moving parts and clip closures of the frame. Especially at the beginning, there is a risk of the fingers and hands getting pinched. Pay particular attention to the fact that no skin protrudes into the opening while snapping the clip.

Check delivery condition

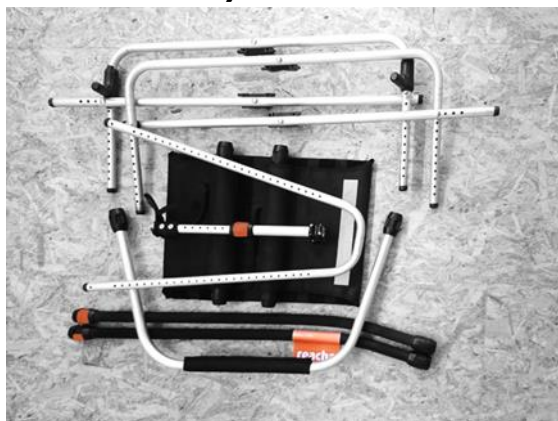

The reacha is delivered in a carton in a disassembled state. Remove all package cushioning and packaging material and spread all parts.

The wheels may be packed in a separate box.

Check if the delivery contents include everything and check all parts for damage during transport. If something is missing or damaged, please contact us at hello@reacha.de.

General snap-lock operation

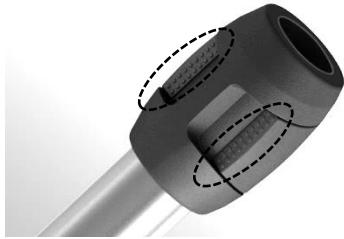

1

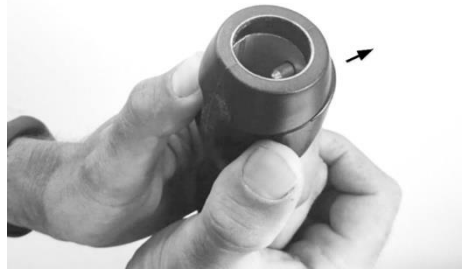

2.1



2.2



3

1. Hold the clip of the snap-lock on the gripping surfaces with one finger each.
2. Press with both thumbs away from the pipe perpendicular to the pipe axis to open the clip.
3. To close, exert light pressure on the clip from above and let it snap into place. 🖐️ Ensure that there is nothing in the gap before you snap the clip into place.

Alternatively, you can also hold the clip with your index finger and thumb and pull it vertically away from the tube to open the snap-locks.

Attention - When assembling and disassembling the trailer there is on the moving parts and the snap-locks danger of pinching for fingers and hands

If it is difficult to open the snap locks, you can leave them open for more than 12 hours to reduce preload.

Assembling mainframe

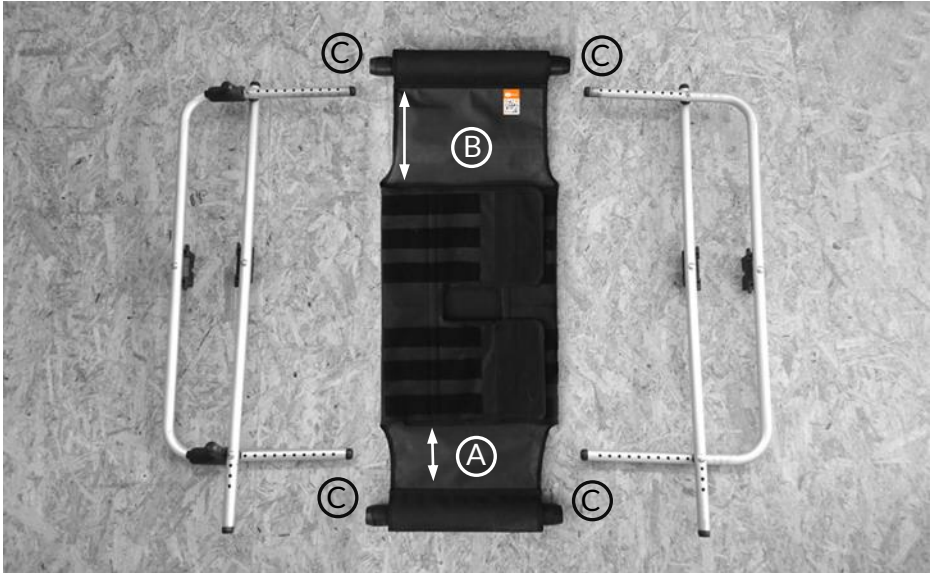

1

For assembly you can check our video or follow the description below.

Video:

<https://youtu.be/ZAP38lhBvIc>



Description:

1. Place the wheel frames and the trunk with the connecting pipes on the floor as shown in the picture. Pay attention to the alignment of the trunk: **short** side (A) below; **long** side (B) above!
Open the snap-locks (C) on the connecting tubes so that the wheel frames can be inserted.
To check the position, there is also a sewn-in QR code on the inside of (B) with which you can call up the assembly instructions.

NOTE

If you want to use a bow with your reacha, you must first attach the bow adapters to the mainframe. Follow the instructions on page 25 ff.

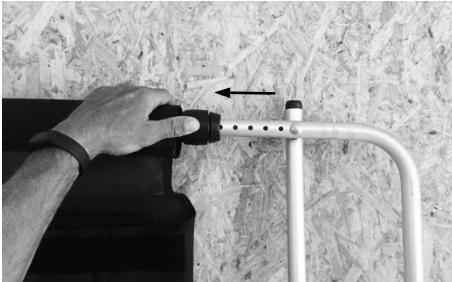

2



3

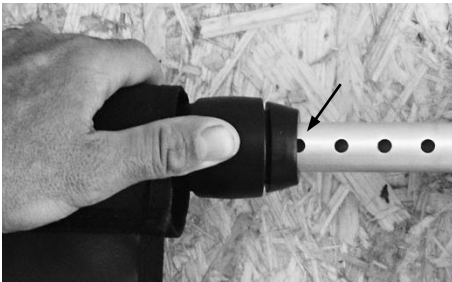

4

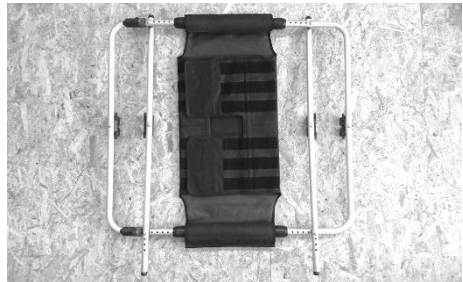

5

2. Guide the side ends of a wheel frame first into the connecting pipes in the trunk.
3. Close the snap locks at a desired hole position.
4. The snap-locks are in the correct position to close when exactly half a hole is visible.
It is best to leave the snap-locks open until the drawbar is attached, as this keeps the frame more mobile and makes it easier to attach the tubes.
5. Attach the second wheel frame in the same way. The mainframe is completely assembled and now the boom must be attached.

UNPACKING AND INITIAL ASSEMBLY

Tow bar assembly

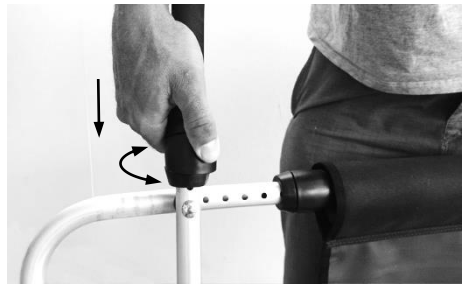
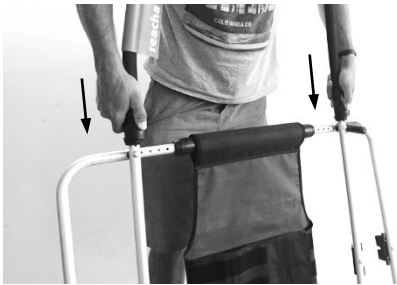
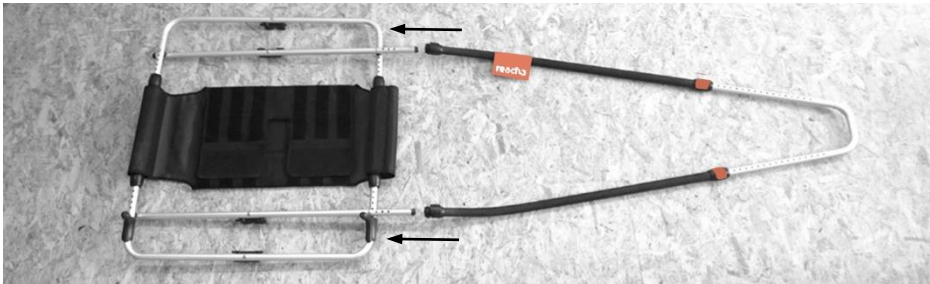
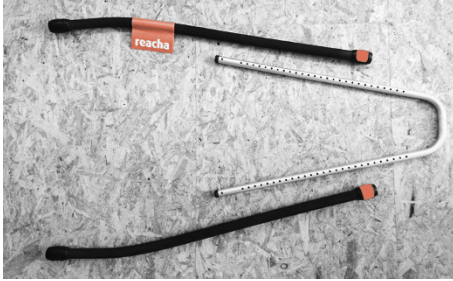

1. Use both bars (left and right) and the bar extension to assemble the tow bar. Make sure the bar with the Recha logo is on the right side (see picture 1)
2. Guide the bar extension with the holes upwards into the **orange** snap locks of the bars. Let the bar extension go up a few holes without closing the snap-locks, so that the tow bar can be adjusted flexibly in the next step.
3. Insert the two curved ends of the tow bar with the snap lock open onto the tube ends of the mainframe. (Picture 3.1)

It is easiest to do this while standing, because then you have the floor as a counter-support. (Picture 3.2).

4. You need to rotate the two short ends of the spar slightly inwards and then release the locking mechanism of the snap-locks to engage the snap-locks. The further you pull out the main tube at the top of the spar, the easier it is. The torsion increases with a wider adjustment of the wheel frame. Therefore, it is easiest, when the mainframe is mounted on the narrowest hole position of the mainframe.

Wheel assembly



WARNING !

The wheel mounts of the reacha are designed for wheels with a hub width of 100mm, with a minimum diameter of 20 " and a maximum diameter of 26". The width of the tires must not exceed 4.0 ". The tightening torque for mounting must be between 5.0 and 7.5 Nm. Only the wheels that meet these requirements are to be used, otherwise there is a risk of damage, injuries and accidents.



WARNING !

Check the wheels for a secure position before every ride. Otherwise it can cause damage, serious injuries or accidents with life-threatening danger.

UNPACKING AND INITIAL ASSEMBLY

General on quick releases

The wheel mount is optimized for use with quick releases. These are already included in the supplied wheels.

However, wheels with lock-nuts can also be used. If you want to mount your own wheels, use only those which correspond with the above mentioned specifications.

A quick release essentially consists of two operating elements:

- The hand lever (A) on one side of the hub: it converts the closing movement into clamping force via a lever.
- The lock-nut (B) on the other side

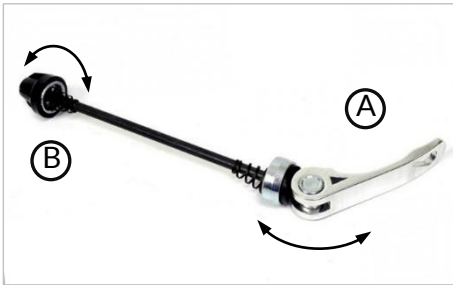

Wheel assembly with quick-releases

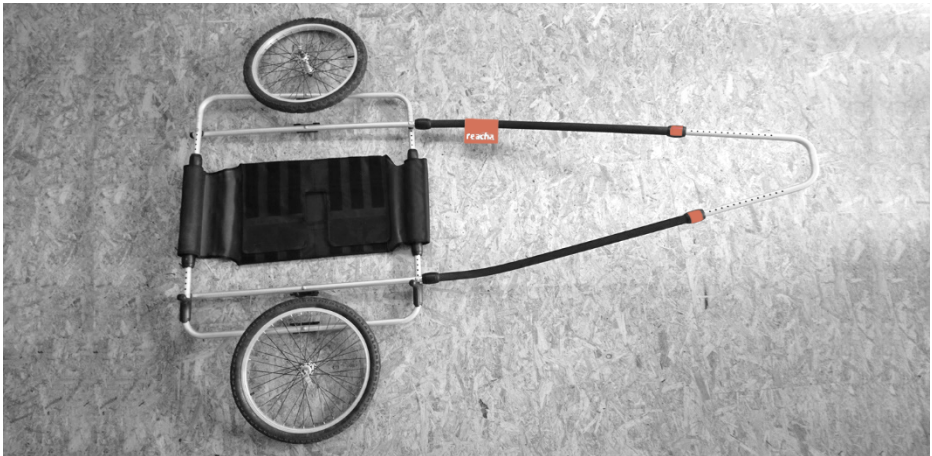

Place the prepared frame with the wheels on the floor.
Leave the snap-locks of the main frame open for wheel mounting.

UNPACKING AND INITIAL ASSEMBLY

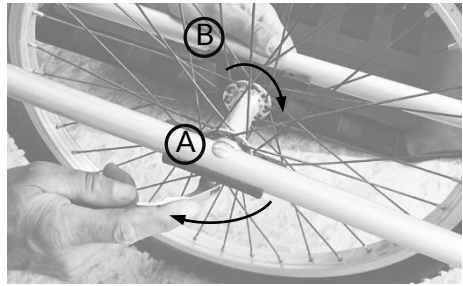
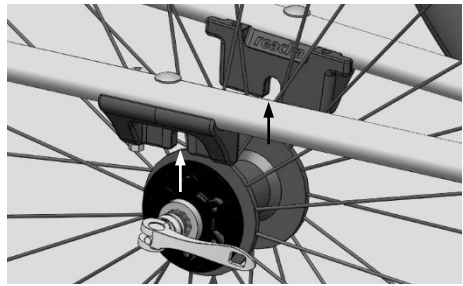
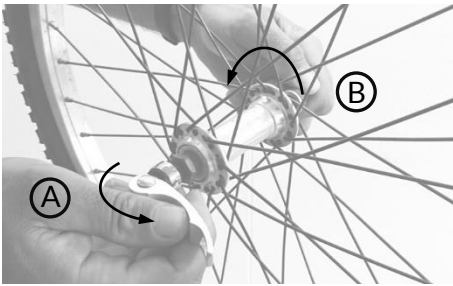

1. Open the hand lever (A), hold it firmly with one hand and unscrew the lock-nut (B) counter-clockwise until the hub fits into the recess of the wheel mount.
2. Place the hub in the wheel mount such that it sits firmly in the dropout.
3. Close the hand lever (A) halfway so that it is in extension to the hub. Turn the lock-nut (B) clockwise with one hand while holding the hand lever with the other hand until you feel a slight resistance. Then close the hand lever with the ball of your hand. Finally, it should be certainly difficult to move the lever, but it should also be possible to completely close it. If this is not the case, open the lever halfway and increase (clockwise) or decrease (counter-clockwise) the clamping force by turning the lock-nut.
4. In the final position, the clamping lever must be parallel to the wheel and must not protrude. It must not be possible to twist it.
5. Mount the other wheel in the same way.

Trunk assembly



1



2.1



2.2

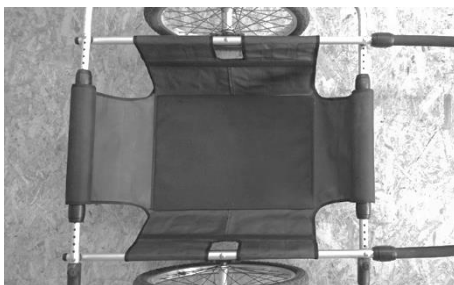

3

1. Open the Velcro of a sidewall and fold the two ends over the inner tube of the wheel mount
2. Position the Velcro strips on above the other and lock them by pressing them together.
3. Follow the same procedure on the other side. The trunk is completely assembled.

**CAUTION !**

In case of heavily punctured load of the trunk bottom, the plastic plate inserted in it should ideally be replaced by a wooden board with the following dimensions: 51.5 cm in length, 38.5 cm in width and 6-10 mm in height.

You can easily remove and reinsert the plastic plate after opening the Velcro flap. Make sure to carefully close the Velcro flap again to secure the plastic plate against slipping out.

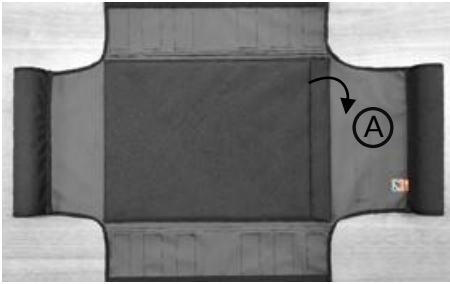

1

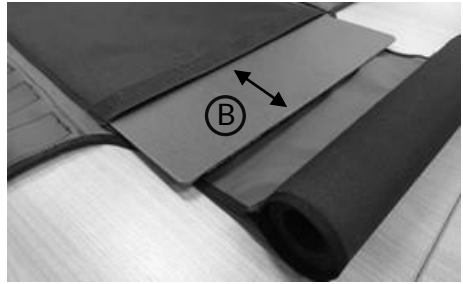

2

Width and length adjustment

The Reacha is adjustable in width and length as follows:

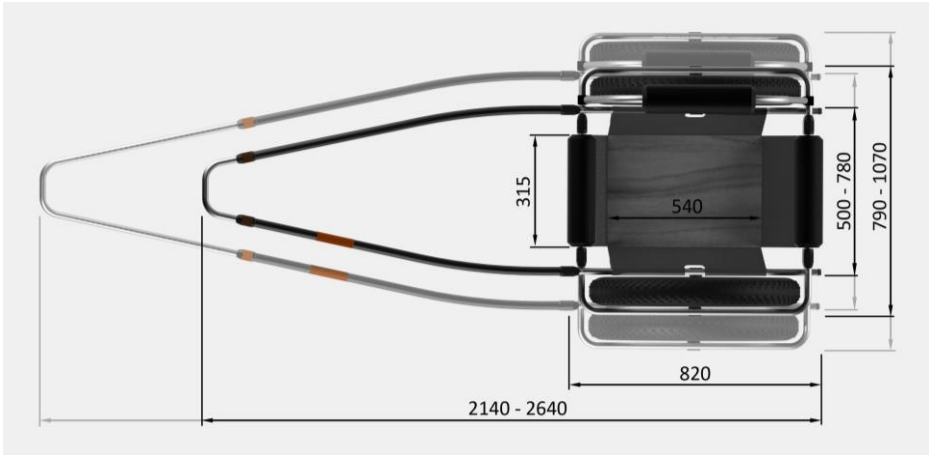

The length of the tow bar must also always be adjusted with the width adjustment of the mainframe.



WARNING !

The mainframe of the reacha has a maximum inner width of 780 cm and outer width of 1075 cm. This setting is reached when 6 holes are visible per bar. Never set the mainframe wider than this setting, otherwise the mainframe will not be sufficiently stable. Failure to do so may lead to damage, serious injuries or accidents with life-threatening consequences.

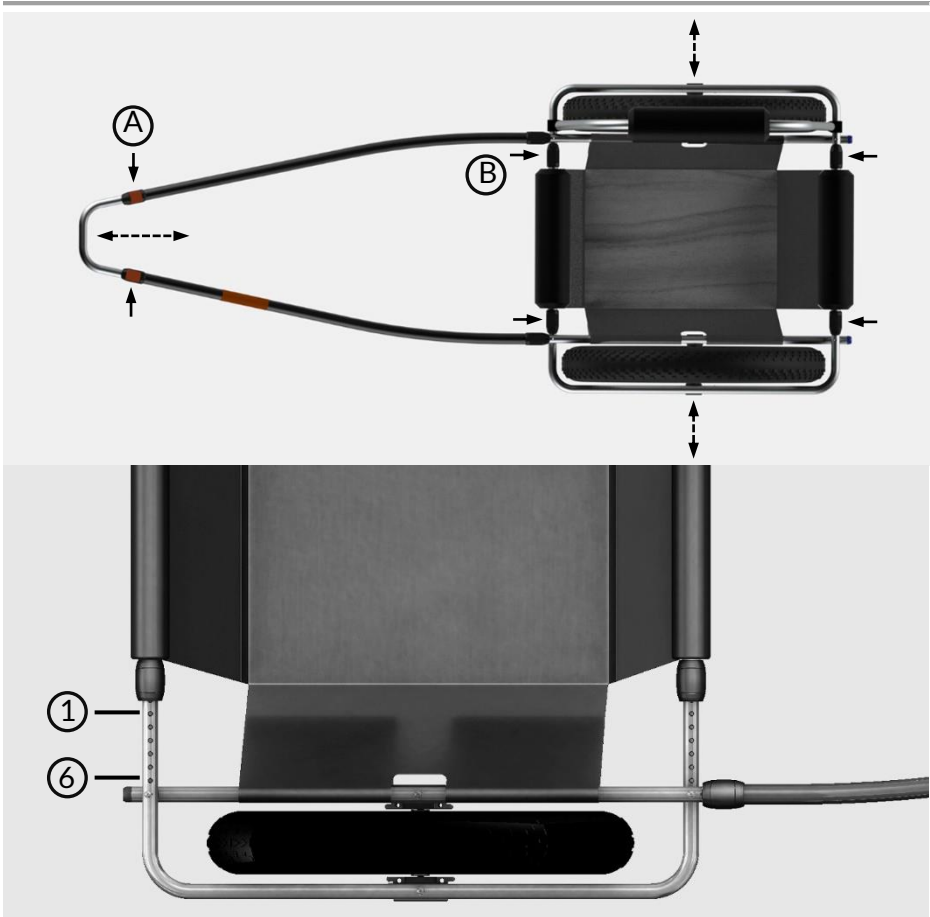

1. Open all snap locks on the tow bar (A) and (B).
2. Pull the wheel frame evenly at the front and rear of the mainframe's connecting pipes. Make sure that no more than 6 holes are visible. Otherwise, sufficient stability is not guaranteed. Close the snap-locks on the connecting bars (B).
3. Pull the bar extension out of the bars until the tension in the tow bar decreases noticeably. The wider you set the mainframe, the further you have to set the tow bar extension. Close the snap-locks subsequently (A).

TRANSPORT AND STORAGE

The reacha can be disassembled for transport and storage.

1. Open the quick releases of the wheels and take them out of the wheel mounts.
2. Set the mainframe back to the middle setting to reduce tension in the spar.
3. Pull out the main pipe of the tow bar with the snap-locks open to reduce the torsion in the tow bar tubes.
4. Open the snap-locks of the tow bar at the connection to the frame and withdraw the spar. Subsequently remove the main pipe from the side pipes.
5. Open the snap locks on the mainframe and pull the wheel frames out of the central tubes. Remove the trunk from the mainframe by opening the Velcro and removing the trunk.

You can transport the frame parts in the trunk as a transport bag for easy transport.

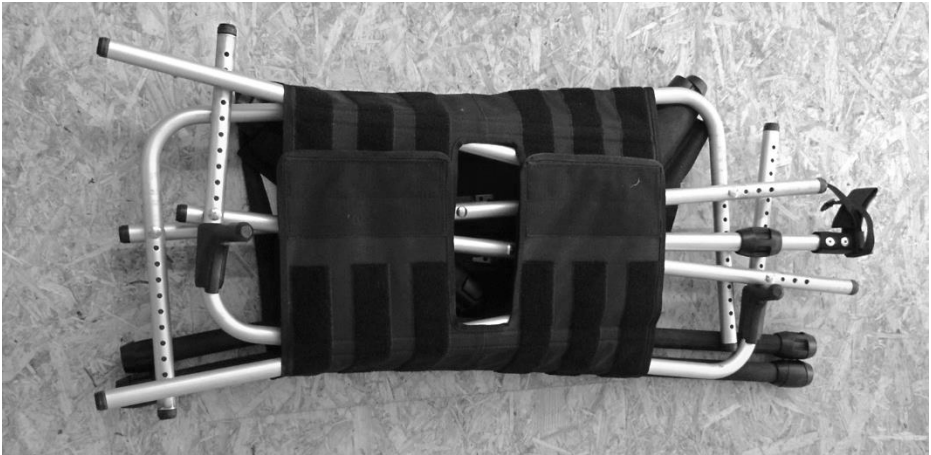



1

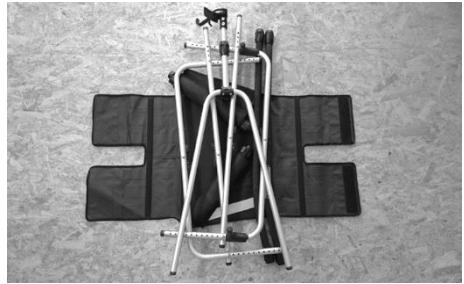

2



3



4

1. For this purpose, lay the trunk on the floor. On one side there are Velcro pointing upward, which you will use for closing the transport bag.
2. Place the loose frame components in the trunk.
3. Fold the side of the trunk against the above-described Velcro over the frame parts.
4. Pull the other side of the trunk over the frame parts and close the Velcro.

NOTE

Make sure that no pointed parts of the frame are directly placed on the fabric of the trunk and that the wheels are not improperly placed on the trunk to avoid any damage to the trunk. Use cushioning material if required.

Please ensure that protruding frame parts do not scratch the trunk floor or floor when stowing in the car or at home.



CAUTION!

The reacha can be transported only inside your car, otherwise it could get damaged.

Do not place heavy objects on the reacha, otherwise the frame parts could be bent.



CAUTION!

Do not store the reacha at temperatures below -20 degrees Celsius, otherwise the textile of the trunk could be damaged. Store the reacha only in a dry condition and protected from moisture, otherwise there is a risk of mould formation. Avoid keeping it in direct sunlight for a long period of time, as this could damage the textile of the trunk. Never leave your reacha in the rain for a long time, as this can damage the textile trunk.

ACCESSORIES

Bow



You must first pre-assemble the two Bow connectors (A) on the mainframe before using the bow (B) for the first time. The steps mentioned on the following pages are required for this purpose.



WARNING !

The bow must be assembled properly; otherwise there is a risk of accidents with damage and life-threatening injuries.



CAUTION !

When loading, make sure that the load is not dragged on the tire. It could get damaged. Especially, inflatable SUPs or boats can leave scratches on the tire.

ACCESSORIES

Initial assembly

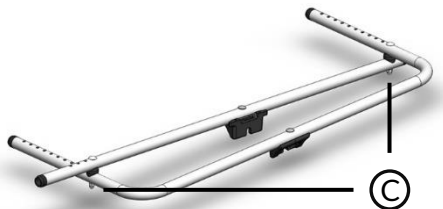

1.1

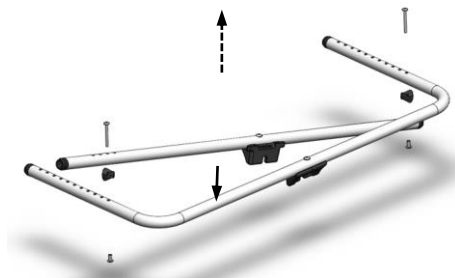

1.2



2

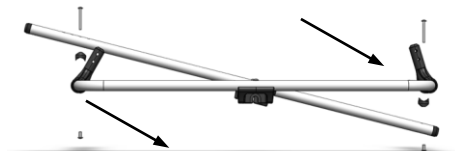

3.1

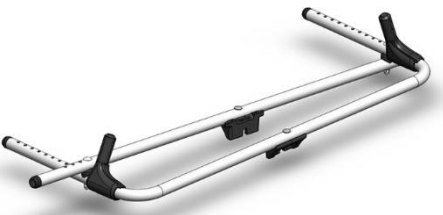

3.2

1. Disassemble the wheel frame on which you want to attach the bow by screwing on the screw connection (C), consisting of a raised countersunk screw and a round nut, each with hexagon socket, and thus loosen the two connections of the tubes.
2. Slide the two bow connectors with the long side towards the mainframe outside onto the curved tube of the wheel frame.
3. Screw all components back together (cap nut 7 Nm tightening torque). Make sure that the straight tube with the long end rests on

top again and the side with the short one below. The saddle discs are to be positioned between the tubes again.

Attaching the bows

The wheel frame is now ready for attaching the bows:

1. Open the snap-locks of the bow and put the bow on the bow-connector.
2. Then insert the bow on the second bow-connector and close the snap locks.
3. The bow is fully mounted.



1.1



1.2



2



3

By using the snap-locks you can add or remove the bow whenever you like.

ACCESSORIES

Attaching the reacha pro bows

The bow of the reacha pro model is based on the standard bow but comes with an additional aluminium plate attached to it. For mounting the bow follow the steps on page 27 (Attaching the bow). In addition, bend the aluminium plate inwards (A) while sliding it onto the second bow-connector (B). Also make sure that the flap of the aluminium plate ends up on the inner side of the frame of the trailer (C).

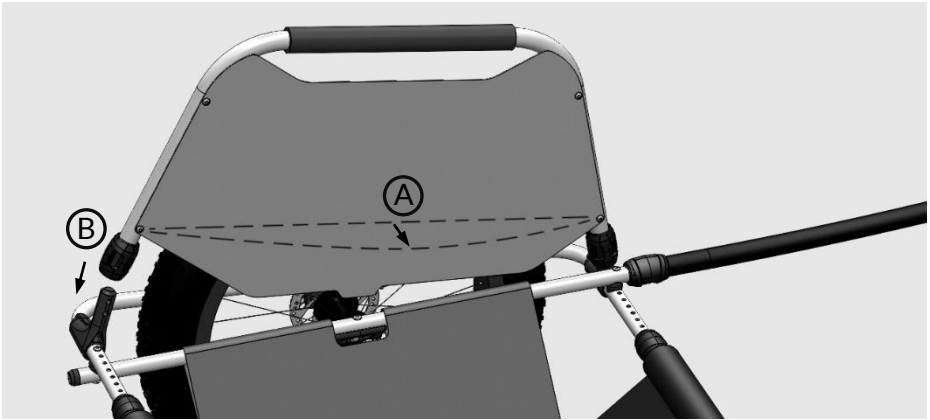

Bike Connector

Assembly to the reacha

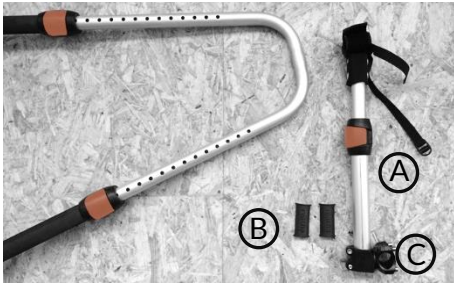

1



2.1

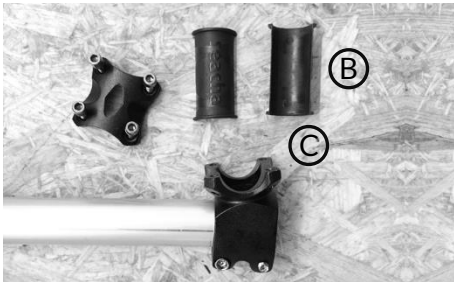

2.2



3

1. The bike connector connects the trolley to a bike and must be first attached to the tow bar extension. The delivery contents include the length-adjustable bike connector (A) with a two-part adapter sleeve (B).
2. Open the cross connector (C) at the bike connector by unscrewing the four screws. Keep the two-part adapter sleeve ready.
3. Place one half of the adapter sleeve in the open cross connector of the bike connector.

ACCESSORIES

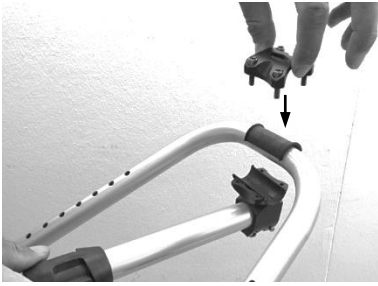

4

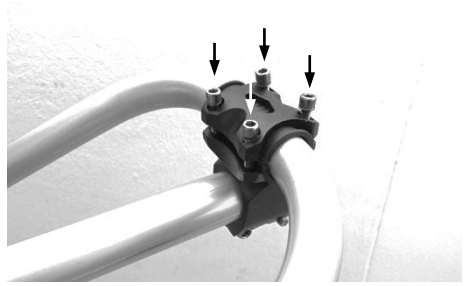

4

4. Place the second half of the adapter sleeve on the tow bar extension and close the cross connector.
5. Tighten the four screws of the cross connector only as much that it can still be turned.

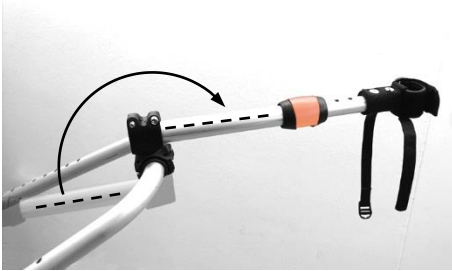

6



7

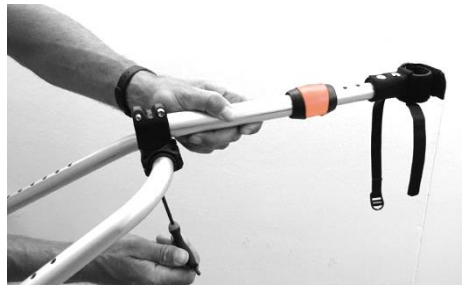

8

6. Now turn the bike connector forward by approx. 180°.
7. Here, depending on its later position on the seat post, make sure that it is aligned horizontally to the road. The length of the bike connector should be adjusted so that the tow bar is not dragged on the bike.
8. Now tighten the screws on the bike connector such that they cannot be turned any further (**tightening torque 12 Nm**)

Attaching to the bike

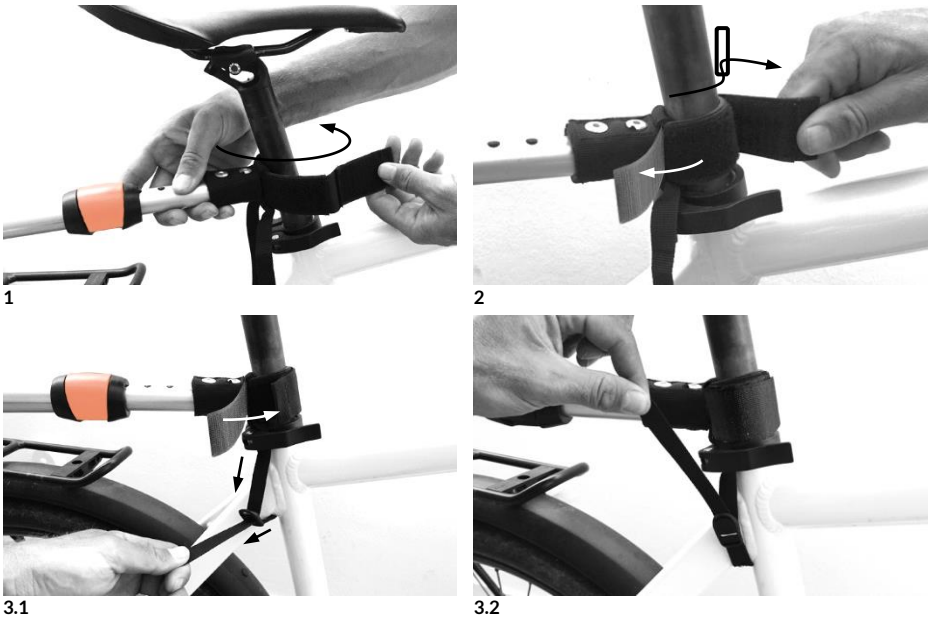

1. Place the Velcro strap of the bike connector at the desired height around the seat post
2. Run the Velcro strap through the loop of the bike-connector, stress so much that the bike connector cannot slip anymore and close the Velcro strap.
3. Fix the bike-connector in height with the help of the lashing strap by attaching it downwards around a suitable bicycle frame component and close the securing strap.

NOTE

Always remove the bike connector from the bike when you take off your bike. Otherwise, the bike connector gets twisted and may get damaged.

Please also note the general information regarding the use of reacha in road traffic on pages 5 ff. of this instruction.

ROAD TRAFFIC LICENSING REGULATIONS

While using the reacha as a bike trailer the lighting must follow the road traffic licensing regulations in your respective country.

Therefore, a DIN certified reflector set including clamps is delivered together with the bike connector (1).



1
A mounting sample is shown below: front view (2), back view (3)

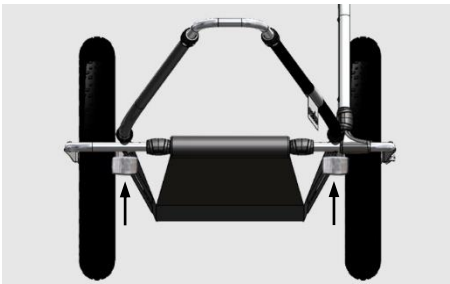

2

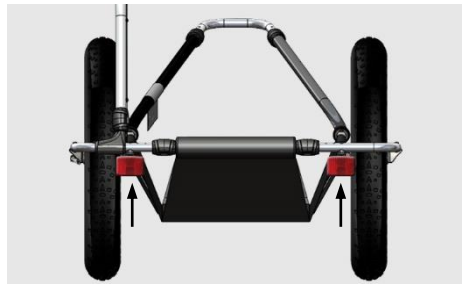

3

Please ensure that you comply with the road traffic regulations in your country before using reacha in traffic.

MAINTENANCE, CARE AND DISPOSAL

Cleaning after use in sand and salt water

After every use at sea or near salt water and sand, completely disassemble the reacha and clean all parts with fresh water to remove salt and grains of sand from the pipes. The similar cleaning is required after use in winter on roads with gravel and road salt.

General cleaning

Clean the frame parts, wheels and the textile trunk with fresh water, a soft brush and a gentle cleaning agent, as needed. Use bio-degradable cleaners wherever possible and make sure that the environment is not harmed.

Never use solvents, cleaner's solvent or other aggressive substances. They can damage or destroy the fabric cover or the metal parts. Do not use a high-pressure cleaner. It could damage the textile, the metal pipes or it could penetrate water in the bearings of the wheels.

In order to protect the metal parts and to preserve the sliding properties of the pipes, you can apply non-greasy silicone spray. Greasing oils and penetrating lubricants damage the plastic elements.

Wheels

Check the wheels regularly for the correct air pressure. Have the wheels checked by a dealer at least once a year. Pay attention to a sufficient tread depth, axle bearing and spoke tension.

Disposal

We hope you will enjoy your reacha for a long time. If you want to put it out of service, be sure to dispose of it properly. If you have any questions, contact your dealer or us. This also applies to wear parts such as tires.

TECHNICAL SPECIFICATIONS

Overall dimensions small (smallest setting with spar and wheels)	2140 mm x 790 mm		
Overall dimensions Large (largest setting with spar and wheels)	2640 mm x 1070 mm		
Packing size disassembled (L x B x H)	1200 mm x 600 mm x 200 mm		
Inner dimensions trunk (L x B x H)	530 mm x 380 mm x 200 mm		
Unladen weight (without wheels)	5,1 kg		
Permissible max. total weight (Trailer with cargo as handcart)	70 kg		
Maximum cargo load (Hand-cart)	60 kg		
Maximum speed trailer Maximum speed hand-cart	25 km/h		
Lowest temperature during use / storage	-20 °C		
Wheel size reacha SPORT	compact	street	beach
	20"	24"	20" fat
Wheel size reacha CITY	compact	street	beach
	20"	24"	20" fat
Wheel size reacha PRO	pro		
	26" fat		

GUARANTEE AND WARRANTY

Defects caused by improper use, forceful impacts, inadequate maintenance or normal wear and tear are excluded from the liability for material defects. The duration of the legal warranty depends on the respective country-specific regulations.

Reacha contains parts or components that are subject to natural wear even in normal use. However, this wear and tear is very much dependent on the individual type and intensity of use and the respective status of maintenance and care.

Especially in case of intensive use (daily use in all types of weathers, esp. in winter and near salt water, use of pedelec as a towing bike, etc.), individual parts or components can reach their wear limit even before the expiry of the legal warranty period. This concerns use-dependent premature wear and tear and not any product defect.

In addition to the individual type and intensity of use, as well as care and maintenance, reaching the wear limit depends on the following factors:

- The mileage
- The load of luggage
- The driving style (Intensity of starting and braking, high-speed at curves
- The impact of the weather (UV radiation, humidity, impurities, temperature, salty air, contact with salt water, salt-strewn streets)
- Storage (storing outside for longer periods, wet storage)
- The standard of care (intervals of maintenance, use of maintenance products, maintenance and inspection tasks)

IMPRINT

good goods tegernsee UG (limited liability)

Flößergasse 6a

81369 Munich

Managing director: Florian Zibert

Commercial register: Munich HRB 234 658

Contact: hello@reacha.de

Status: January 2022



August 2015, when our journey started

And now we wish you lots of fun and joy with your reacha!

If you have any questions, feedback or suggestions for us, feel free to contact us anytime at hello@reacha.de.

Your reacha Team