



*Actual product appearance may differ from the above simulated scene.

UL Listed Healthcare TVs with Advanced Features for Hospitals

LT572M Series

Commercial Lite	Pro:Centric	Pro:Centric Enhanced	Pro:Centric Smart
-----------------	--------------------	----------------------	-------------------

The LT572M hospital-grade model series is a Pro:Centric interactive television for RF distribution networks (coax). A cost-effective solution for healthcare facilities, the TV features include Pillow Speaker support and Hospital UL Certification, which are designed to enhance patient-centered care.

UL Listed Healthcare TVs with Advanced Features for Hospitals

LT572M SERIES

FEATURES FOR THE HOSPITAL ENVIRONMENT

Pillow Speaker Ready

Audio and video can be controlled directly by a pillow speaker for patient convenience.*

* Requires third-party pillow speaker.

Nurse Call System

The Pro:Centric JAVA application enables the LT572M to provide an interactive program guide and display facility information, such as dietary menus and patient room information.

UL Hospital Grade Listed

The LT572M series is UL listed for use in healthcare and hospital environments.



UL Listed Healthcare TVs with Advanced Features for Hospitals

LT572M SERIES

FEATURE HIGHLIGHTS

Pro:Centric Application Platform

An industry-leading television that supports the Pro:Centric platform, LG's new LT572M Series allows healthcare facilities to customize the patient room experience. The Pro:Centric application enables the LT572M to provide an interactive program guide and display facility information, such as dietary menus and patient room information.*



* May require additional software and hardware to support third-party partner interactive systems or LG's Free-to-Guest Mode / Pro:Centric application

Instant On

When the TV is turned off, the Instant On feature allows the Pro:Centric app to remain loaded giving guests quick access to content when they turn on the TV.



Pro:Idiom

Digital Rights Management (DRM) technology unlocks access to premium content to help assure rapid and broad deployment of HDTV and other high-value digital content.



UL Listed Healthcare TVs with Advanced Features for Hospitals

LT572M SERIES

FEATURE HIGHLIGHTS

External Speaker Out

Enhance the entertainment experience with an additional speaker (sold separately). Guests can listen to the TV audio from other rooms within their suite, not only the room where the TV is located.



First Use Wizard

The First Use Wizard offers quick configuration options including "Express Script" which allows you to easily enable and configure Hospital Mode features.

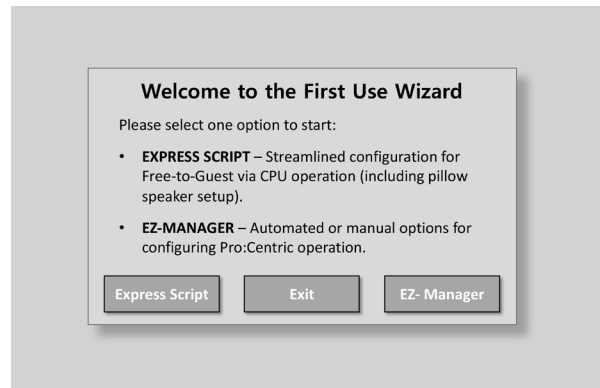

Above screen image is simulated.

Self Diagnostics via USB

The LT572M TV Series stores 24-hour diagnostic data, which can be saved to a USB memory device, enabling service engineers to identify technical issues quickly and easily.



Multi-code IR

Multi-code IR* function eliminates any remote control signal interference between TVs in rooms with multiple TVs installed.

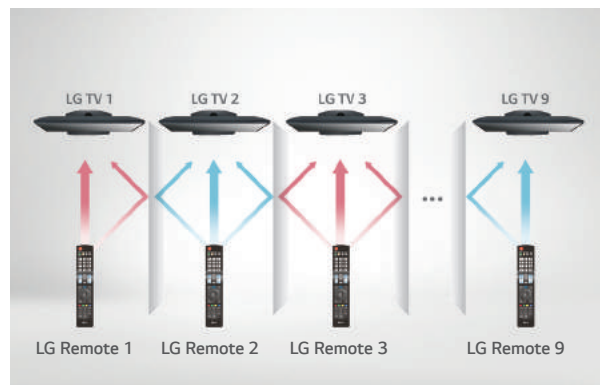

* Requires optional multi-code IR remote.

UL Listed Healthcare TVs with Advanced Features for Hospitals

LT572M SERIES

DIMENSIONS

43"

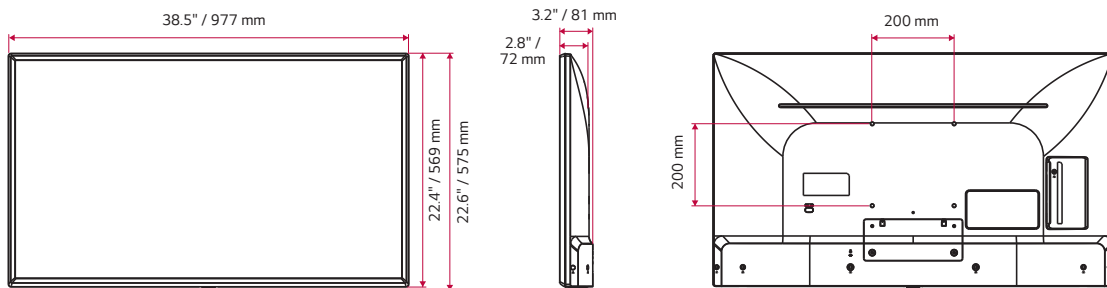

32"

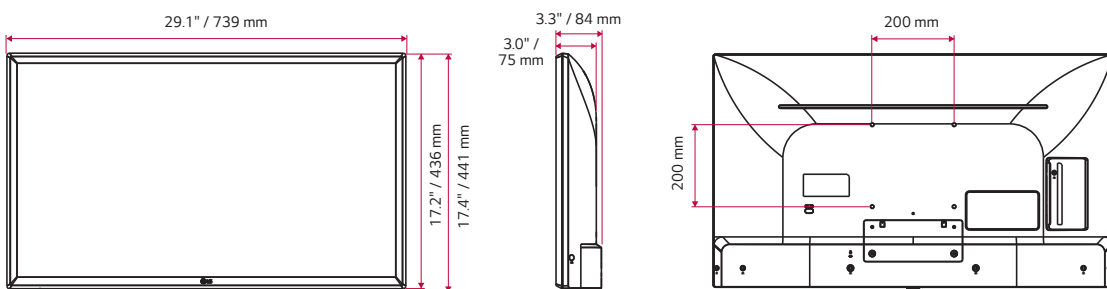

24"

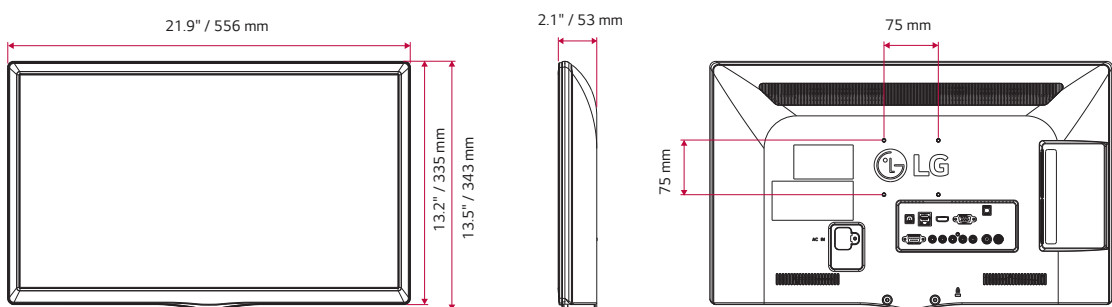

Design and specifications subject to change without notice. Please contact your LG sales team to verify before ordering.

UL Listed Healthcare TVs with Advanced Features for Hospitals

LT572M SERIES

SPECIFICATIONS

	43LT572M0UC	32LT572MBUC	28LT572MBUC	24LT572MBUB	
DISPLAY	Diagonal Size	43"	32"	28"	24"
	Resolution	1,920 x 1,080 (FHD)	1,366 x 768 (HD)	1,366 x 768 (HD)	1,366 x 768 (HD)
	Backlight Unit Type	Direct LED	Direct LED	Direct LED	Edge LED
	Brightness (Nits)	400	240	200	250
	Dynamic Contrast Ratio	1,000,000:1	1,000,000:1	1,000,000:1	1,000,000:1
	Static Contrast Ratio	1,200:1	1,200:1	1200:1	3,000:1
	Refresh Rate	60 Hz	60 Hz	60 Hz	60 Hz
	Life Span (Hours)	30,000	30,000	30,000	30,000
BROADCASTING	Analog	NTSC	NTSC	NTSC	NTSC
	Digital	ATSC / Clear QAM / VSB	ATSC / Clear QAM / VSB	ATSC / Clear QAM / VSB	ATSC / Clear QAM / VSB
AUDIO	Speaker (Sound Output)	10 W + 10 W	5 W + 5 W	5 W + 5 W	5 W + 5 W
	Speaker System	2.0 ch	2.0 ch	2.0 ch	2.0 ch
FEATURES	Pro:Centric Application (JAVA)	Yes	Yes	Yes	Yes
	Pro:Centric Server	PCS200S, PCS400R	PCS200S, PCS400R	PCS200S, PCS400R	PCS200S, PCS400R
	Pro:Idiom (H/W Type)	Yes	Yes	Yes	Yes
	First Use Wizard	Yes	Yes	Yes	Yes
	SI Compatible	Yes (MPI, RS-232C)	Yes (MPI, RS-232C)	Yes (MPI, RS-232C)	Yes (MPI, RS-232C)
	Simplink (HDMI-CEC) plus CEC-HTNG	Yes (1.4)	Yes (1.4)	Yes (1.4)	Yes (1.4)
	IR Out	Yes (MPI, RS-232C)	Yes (MPI, RS-232C)	Yes (MPI, RS-232C)	Yes (MPI, RS-232C)
	Multi-code IR	Yes	Yes	Yes	Yes
	Installer Menu	Yes	Yes	Yes	Yes
	Welcome Screen (Boot Logo)	Yes	Yes	Yes	Yes
	Instant On	Yes	Yes	Yes	Yes
	RJP (Remote Jack Pack) Compatibility	Teleadapt / Guestlink (HDMI-CEC)	Teleadapt / Guestlink (HDMI-CEC)	Teleadapt / Guestlink (HDMI-CEC)	Teleadapt / Guestlink (HDMI-CEC)
	Auto Off / Sleep Timer	Yes / Yes	Yes / Yes	Yes / Yes	Yes / Yes
	Smart Energy Saving	Yes	Yes	Yes	Yes
	Motion Eye Care	Yes	Yes	Yes	Yes
UL Hospital Grade Listed	Yes	Yes	Yes	Yes	
Pillow Speaker	Yes	Yes	Yes	Yes	
Embedded b-LAN	Yes	Yes	Yes	Yes	

Design and specifications subject to change without notice. Please contact your LG sales team to verify before ordering.

UL Listed Healthcare TVs with Advanced Features for Hospitals

LT572M SERIES

SPECIFICATIONS

	43LT572M0UC	32LT572MBUC	28LT572MBUC	24LT572MBUB	
INTERFACES	HDMI In	2 (1.4)	2 (1.4)	2 (1.4)	2 (1.4)
	USB	1 (2.0)	1 (2.0)	1 (2.0)	1 (2.0)
	RF In	Yes	Yes	Yes	Yes
	AV In	3.5 mm (GND, R, L, V)	3.5 mm (GND, R, L, V)	3.5 mm (GND, R, L, V)	3.5 mm (GND, R, L, V)
	Digital Audio Out	Optical	Optical	Optical	Optical
	RS-232C In (Control & Service)	3.5 mm Stereo Jack	3.5 mm Stereo Jack	No	No
	Speaker Out - Line Out	3.5 mm Stereo Jack	3.5 mm Stereo Jack	3.5 mm Stereo Jack	3.5 mm Stereo Jack
	TV-Link Configuration (for b-LAN)	3.5 mm Stereo Jack	3.5 mm Stereo Jack	3.5 mm Stereo Jack	3.5 mm Stereo Jack
	MPI Port	RJ12	RJ12	RJ12	RJ12
	Service Only	3.5 mm Stereo Jack	3.5 mm Stereo Jack	3.5 mm Stereo Jack	3.5 mm Stereo Jack
	Pillow Speaker Interface (6 Pin)	Yes	Yes	Yes	Yes
MECHANICALS	VESA Compatible (W x H)	200 x 200	200 x 200	100 x 100	75 x 75
	Kensington Lock	Yes	Yes	Yes	Yes
	Front Color	Ceramic Black	Ceramic Black	Ceramic Black	Ceramic Black
	Weight	17.6 lbs / 8.0 kg	10.8 lbs / 4.9 kg	9.2 lbs / 4.2 kg	7.7 lbs / 3.5 kg
	Shipping Weight	22.9 lbs / 10.4 kg	13.4 lbs / 6.1 kg	13.4 lbs / 6.1 kg	10.4 lbs / 4.7 kg
	Dimensions (W x H x D) (Depth: Front to VESA)	38.5" x 22.6" x 2.8" / 977 x 575 x 72 mm	29.1" x 17.4" x 3.0" / 739 x 441 x 75 mm	25.6" x 15.4" x 3.1" / 650 x 390 x 78 mm	21.9" x 13.5" x 2.1" / 556 x 343 x 53 mm
	Dimensions (W x H x D) (Depth: Front to Lower Back)	38.5" x 22.6" x 3.2" / 977 x 575 x 81 mm	29.1" x 17.4" x 3.3" / 739 x 441 x 84 mm	25.6" x 15.6" x 3.1" / 650 x 395 x 78 mm	21.9" x 13.5" x 2.1" / 556 x 343 x 53 mm
	Shipping Dimensions (W x H x D)	41.7" x 26.0" x 6.0" / 1,060 x 660 x 152 mm	32.0" x 20.1" x 5.6" / 812 x 510 x 142 mm	31.7" x 18.1" x 7.3" / 804 x 461 x 185 mm	27.6" x 15.8" x 5.5" / 700 x 402 x 140 mm
	Bezel Width - On Bezel (L / R / T / B)	16.3 mm / 16.3 mm / 16.3 mm / 19.4 mm	18.8 mm / 18.8 mm / 18.8 mm / 21.6 mm	21.1 mm / 21.1 mm / 20.9 mm / 23.6 mm	17.3 mm / 17.3 mm / 18.8 mm / 29.8 mm
Bezel Width - Off Bezel (L / R / T / B)	16.3 mm / 16.3 mm / 16.3 mm / 19.4 mm	18.8 mm / 18.8 mm / 18.8 mm / 21.6 mm	20.2 mm / 20.2 mm / 20.0 mm / 22.7 mm	16.3 mm / 16.3 mm / 17.8 mm / 22.8 mm	
POWER	Power Supply	120 V, 50 / 60 Hz	120 V, 50 / 60 Hz	120 V, 50 / 60 Hz	120 V, 50 / 60 Hz
	Max Power Consumption	90 W	43 W	47 W	45 W
	Typical Power Consumption	63.6 W	34.4 W	32 W	29 W
	Standby Power Consumption	Less than 0.5 W	Less than 0.5 W	Less than 0.5 W	Less than 0.5 W
ACCESSORIES & OTHER	Standards	UL	UL	UL	UL
	EMC Certification	FCC	FCC	FCC	FCC
	Power Cord	1.8 m, Right Angle	1.8 m, Right Angle	1.8 m, Right Angle	1.8 m, Right Angle
	Remote Control	Yes (Installer Remote)	Yes (Installer Remote)	Yes (Installer Remote)	Yes (Installer Remote)
	AV In Adaptor Cable	3.5 mm Plug to 3 RCA Jacks	3.5 mm Plug to 3 RCA Jacks	3.5 mm Plug to 3 RCA Jacks	3.5 mm Plug to 3 RCA Jacks
	Chromecast Anti-theft Cover	Yes (Optional)	Yes (Optional)	Yes (Optional)	Yes (Optional)
	Warranty	Two-Year Limited Warranty	Two-Year Limited Warranty	Two-Year Limited Warranty	Two-Year Limited Warranty
	UPC	7 19192 63103 8	7 19192 63104 5	7 19192 63304 9	7 19192 63305 6

Design and specifications subject to change without notice. Please contact your LG sales team to verify before ordering.

CONNECTIVITY



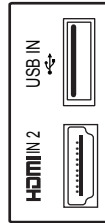
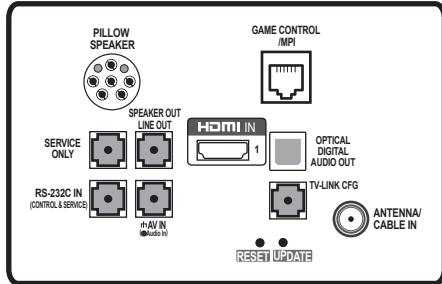

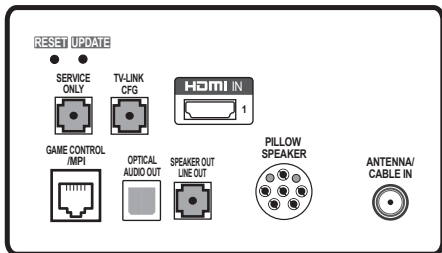

43" / 32"



24"



Design and specifications subject to change without notice. Please contact your LG sales team to verify before ordering.

-  www.lg.com/us/business/commercial-display
-  www.twitter.com/LGCommDisplays
-  www.facebook.com/LGcommercialdisplays
-  www.linkedin.com/company/lg-commercial-displays-usa
-  www.youtube.com/lgcommercialdisplayusa
-  800-228-1236 | Hospitality Sales

LG may make changes to specifications and product descriptions without notice.
 © Copyright 2019 LG Electronics USA, Inc., 2000 Millbrook Dr., Lincolnshire, IL 60069, USA . All rights reserved. LG and the LG logo are registered trademarks of LG Corp. All other trademarks are the property of their respective owners. Prices and products may vary by dealer. Prices, designs, features and specifications are subject to change without notice. All screen images are simulated. Pro:Centric and the "Pro:Centric" logo are registered trademarks of LG Electronics Inc. Pro:Idiom is a registered trademark of Zenith Electronics LLC.
 SPEC_LT572M_0819SD_PR

