

PTAC WIRELESS KITS (DT01A, DS01A, DD01A) INSTALLATION INSTRUCTIONS

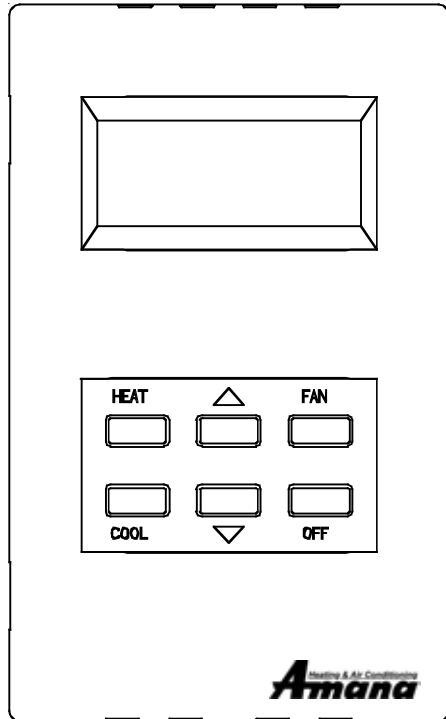

DS01A

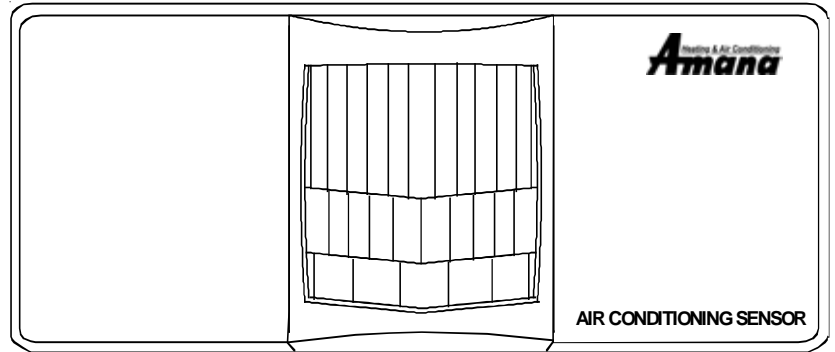

DD01A

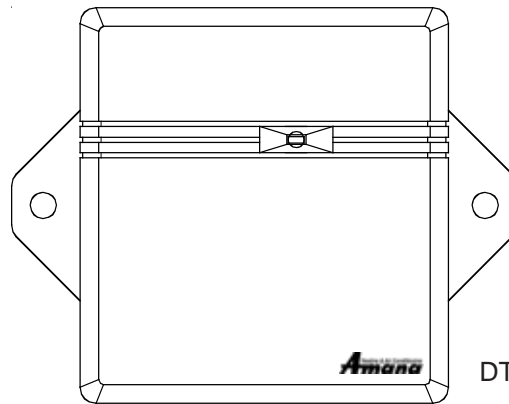

DT01A

The following installation instructions are for a typical installation.
Please contact your PTAC salesperson
for additional assistance and explanation prior to ordering materials or cutting openings.

**USE ONLY ONE DD01A PASSIVE INFRARED MOTION SENSOR (PIR) DOOR
SWITCH COMBINATION DEVICE TO ONE DIGISMART PTAC UNIT.**

ATTENTION INSTALLING PERSONNEL

As a professional installer you have an obligation to know the product better than the customer. This includes all safety precautions and related items.

Prior to actual installation, thoroughly familiarize yourself with this Instruction Manual. Pay special attention to all safety warnings. Often during installation or repair it is possible to place yourself in a position which is more hazardous than when the unit is in operation.

Remember, it is **your** responsibility to install the product safely and to know it well enough to be able to instruct a customer in its safe use.

Safety is a matter of common sense...a matter of thinking before acting. Most dealers have a list of specific good safety practices...follow them.

The precautions listed in this Installation Manual are intended as supplemental to existing practices. However, if there is a direct conflict between existing practices and the content of this manual, the precautions listed here take precedence.

Antenna Installation For DT01A Kit

Do not install this kit on a unit with hydronic heat.

A DT01A antenna must be installed to the PTAC to allow operation of either the DS01A remote RF thermostat or a DD01A combination PIR motion sensor and door switch.



WARNING

To prevent property damage, personal injury or death due to electric shock, disconnect the electrical power supply before installing any accessory kit or performing any maintenance. The "OFF" switch does not disconnect all power to the unit.

Preparation

1. Disconnect power to the unit by unplugging the power cord at the wall outlet or subbase, or disconnect power at the fuse box or circuit breaker.
2. If the cabinet front is screwed to the chassis, remove the 1/4" screw (or screws) located behind the inlet grille. Pull the inlet grille forward from the top of the grille to access screw(s).

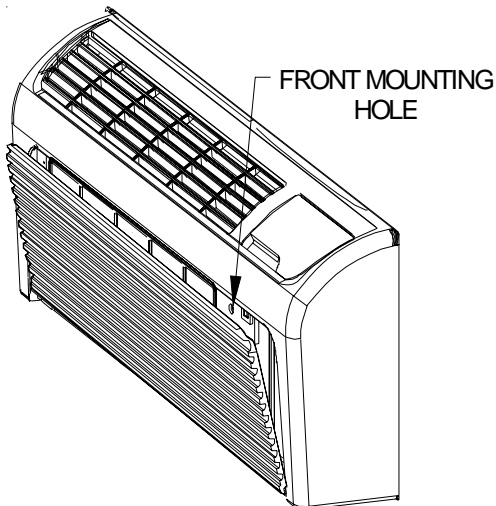

3. Remove cabinet front from chassis by tilting the bottom of the front forward, lifting slightly up and forward.
4. Mount the antenna as high up on the control panel as possible and as far to the right as possible in a location that will not interfere with the reinstallation of the PTAC polymer room front. Mark holes for screw location. Remove antenna housing and drill two 1/8" holes where marked.

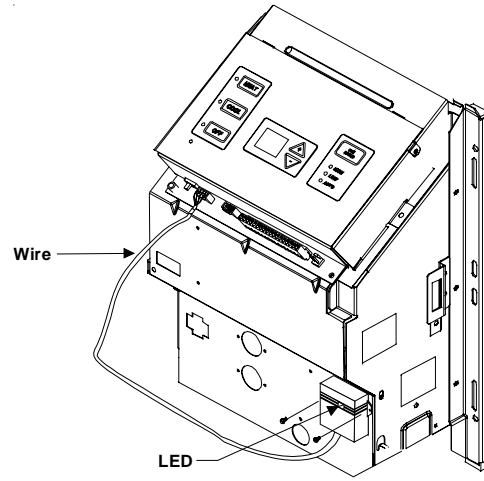

DT01A Mounting

5. Remove antenna cable and route cable through opening in bottom of antenna housing.
6. Mount antenna housing with two screws as shown in figure. (**NOTE:** The Amana® logo should be in the lower right hand corner).
7. Plug wire harness from antenna into connector on the control board to the right of the master switch.
8. Restore power to the PTAC unit.
9. Reinstall the polymer room cover.

NOTE: The LED must be oriented at the **top** of the antenna housing for proper unit operation.

Thermostat Installation for DS01A Kit

NOTE: A DT01A must be installed in the PTAC unit for the DS01A to be operable.

Skip these steps if not installing.

1. Select thermostat mounting location about five feet above the floor, on an inside wall, out of direct sunlight, away from sources of radiant heat (lamps, fireplaces, heating and air conditioning equipment, etc.), away from windows or door to the outside, and avoid areas with poor air circulation. Ensure location is out of the path of foot traffic where a person might accidentally bump into the thermostats and damage the device.
2. Remove thermostat from mounting plate by pulling apart.
3. Place thermostat mounting plate against the wall at desired location and mark placement of mounting holes.
4. If mounting in drywall, tap plastic anchors into wall. For other surfaces, drill a 3/16" hole.
5. Screw mounting plate to the wall. **DO NOT SNAP**

THERMOSTAT INTO PLACE UNTIL AFTER BINDING PROCESS.

6. Install two (2) AAA batteries (included) into the back of the thermostat. Terminals are marked "+" and "-" for polarity.

Mounting Sensor/Door Magnet Installation for DD01A Kit

A DT01A must be installed in the PTAC unit for the DD01A to be operable.

Skip these steps if not installing.

1. Remove motion sensor from mounting plate by pulling apart.
2. Mount the back plate on the door trim directly above the door using the enclosed screws. The bottom of the plate must be within 1/4" of where the magnet will be mounted in the door. Choose a location for mounting the back plate that will provide good coverage of the PIR for motion into the room. Make sure that the DD01A will not interfere with the normal opening and closing of the door.

DO NOT SNAP MOTION SENSOR IN PLACE UNTIL AFTER BINDING PROCESS.

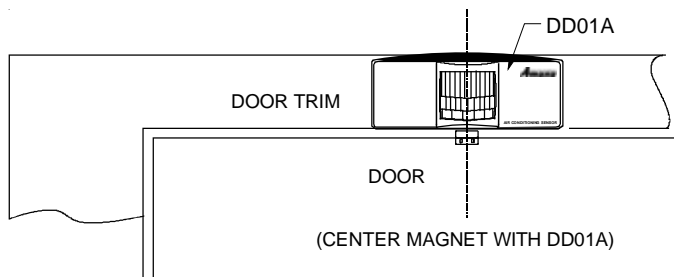

DD01A Mounting

3. Install two (2) AAA batteries (included) into the back of the thermostat. Terminals are marked "+" and "-" for polarity.

Door Magnet Installation

Mount the door magnet on the front of the door where it will be within 1/4" of the bottom center of the motion sensor when the door is closed. Use as many spacers as needed to obtain the 1/2" from the back of sensor mounting plate to center of magnet. Ensure that the magnet will not interfere with the normal opening and closing of the door, but mount the magnet no more than 1/4" from the bottom center of the DD01A.

There are 6, 1/4" thick round spacers supplied with the kit, 3 per screw. Use these spacers if needed, either individually or together, to bring the magnet out approximately 0.50" from the back of the sensor mounting plate. Center the magnet with the motion sensor. Screw in place with the screws provided.



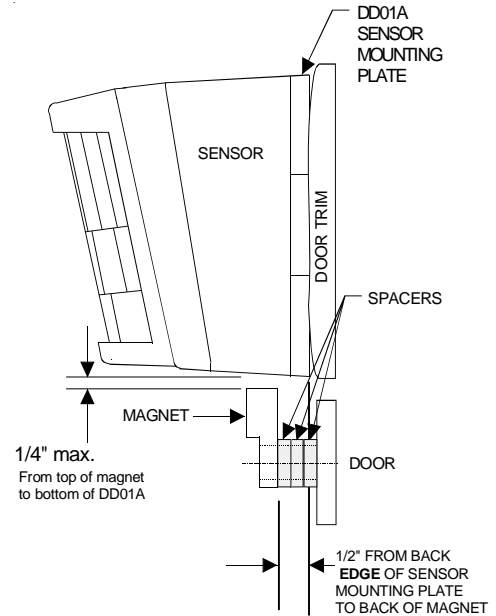





NOTE: If the door is sheet metal, at least one 1/4" spacer per screw must be used to get the magnet away from the surface of the metal material to allow the magnet to operate properly with the DD01A. If the magnet sticks to the door magnetically, then at least one spacer must be used.



Binding of RF Devices

DO NOT ATTEMPT TO BIND MORE THAN ONE ROOM AT A TIME AT THE SAME PROPERTY!!!
RF TRANSMITS THROUGH WALLS.

The wireless devices (DS01A and or DD01A) must be bound to the PTAC DT01A control for proper in-room communication. Ensure the unit is powered but in the OFF position.

1. Press and hold off button on the PTAC until  appears.
2. Press and then immediately release the white tactile button on the back of the DS01A thermostat.  should now be displayed on the PTAC LED display. If  does not show on the display in 1-2 seconds, then press and release the white button a second time. Skip this step if there is no thermostat.
3. Press and then immediately release the white tactile button on the back of the DD01A motion sensor.  or  should now be displayed on the PTAC LED display. If  or  does not show on the display in 1-2 seconds, then press and release the white button a second time. **NOTE:** If both a DD01A and a DS01A are being bound, then the display will show .

Skip if there is no motion sensor.



4. Press "OFF" on the PTAC touchpad to exit the binding sequence.
5. Snap thermostat onto thermostat mounting plate.
6. Snap motion sensor onto motion sensor mounting plate.
7. Configure the device or devices that were bound. See the next section for configuration choices.

Configuration Settings

The PTAC control will need to be configured to work with the wall thermostat (DS01A Kit) if installed. The PTAC control will automatically self-configure to activate pre-configured energy management routine when the DD01A is installed and bound to the PTAC. Additionally, the setback times and setback temperatures can be changed using the configuration settings. If you are using DP01A Front Desk Platform, the PTAC control will need to be configured to identify its room number placement.



Standard and DS01A Configuration

To enter configuration feature mode:

Press and continue to hold the up and down  arrow keys and quickly press the OFF  key twice within a two (2) second time frame. Once you are in the configuration program, you can use the HEAT button to move UP the various configuration settings or the COOL button to move DOWN the configuration settings. The + or - keys will move up or down the selectable codes that you can change for each configuration setting. Ensure that you are in the proper configuration setting before pressing the + or - key as you may accidentally change a setting that you did not intent to change.

The display will alternate between displaying the feature code  and the option code 0 (factory default setting). The



lower right dot on the display will flash. If using a wireless wall thermostat (DS01A Kit), press the up and down 

arrows until  is displayed. **NOTE:** Use the  to toggle between the configuration selected option code for the C1 configuration setting.





Entering Room Number (Skip if not using DP01A Front Desk Platform)



1. The PTAC control can be set for a 4-digit room number. To select the first two digits (floor), press the HEAT 



key until  appears, then press the up  down  arrows to select the first two digits.

2. To select the last two digits of the room number, press the HEAT  key until  appears, then press the up

and down  arrows to select the last 2 digits of the room number.

For example for Room "201", press the HEAT  key until  appears, then press the up  down  arrows to select "02": .

Next to select the last two digits of the room number, press the HEAT  key until  appears, then press the

up and down  arrows to select "01": .

Setback Temps - DD01A

The DD01A and the DigiSmart control can be programmed for 3 different times to activate temperature setbacks. The factory default temperature setbacks are 2° from set point in 30 minutes, 4° in three (3) hours, and 8° in eight (8) hours. For each time, you can select a setback temperature. The amount of setback is the amount of degrees the control will operate from guest's setting in degrees F. If a change to the factory default temperature settings is desired, follow the instructions below.







WARNING



USE OF SETBACK TEMPERATURES



Do not use motion sensing setback temperatures in rooms where incapacitated persons or animals are unable to change the control setting.



An unattended air conditioner with extreme setbacks may result in undesirable or unhealthy temperatures in the conditioned space causing under heating, under cooling or death of persons or animals.



- To select first unoccupied set back temperature, press the **HEAT**  key until  feature code comes up. To scroll to a previously viewed feature codes, press the **COOL**  key.



Once you have scrolled to the  feature, press either the up or down arrow  to scroll to the desired first unoccupied setback temperature. Cooling example: 72° (guest set point) + 2° (Setback temperature) = 74° (operational set point).

- Press **HEAT**  key to scroll to  first unoccupied setback time. The first unoccupied setback time is the time between when the control determines that the room is not occupied and when the control sets the operating set point temperature back. The increments are in hours (.1 = 6 mins., .5 = 30 mins., 1 = 1 hour, etc.). Press either the up or down arrow  to the desired first unoccupied setback time. Example: Operating set point would be 74° instead of 72, 30 minutes (.5 hours) after guest leaves room.

- To select second unoccupied setback temperature, press the **HEAT**  key until  comes up. Press either the up or down arrow  to the desired second unoccupied setback temperature.

- Press **HEAT**  key to scroll to  second unoccupied setback time. Press either the up or down arrow  to the desired second unoccupied setback time.

- Press **HEAT**  key to scroll to  third unoccupied setback temperature. Press either the up or down arrow  to the desired third unoccupied setback temperature.

- Press **HEAT**  key to scroll to  third unoccupied setback time. Press either the up or down arrow  to the desired third unoccupied setback time.

10.. To exit configuration mode:

Press the **OFF**  key. **NOTE:** Configuration feature mode will also automatically exit if no keys are pressed for a period of **two (2) minutes**.

The changes made in configuration mode are now in effect.

NOTE: Additional codes are present and may be accessed within this menu. Contact the manufacturer for additional information.

Typical Room Layouts

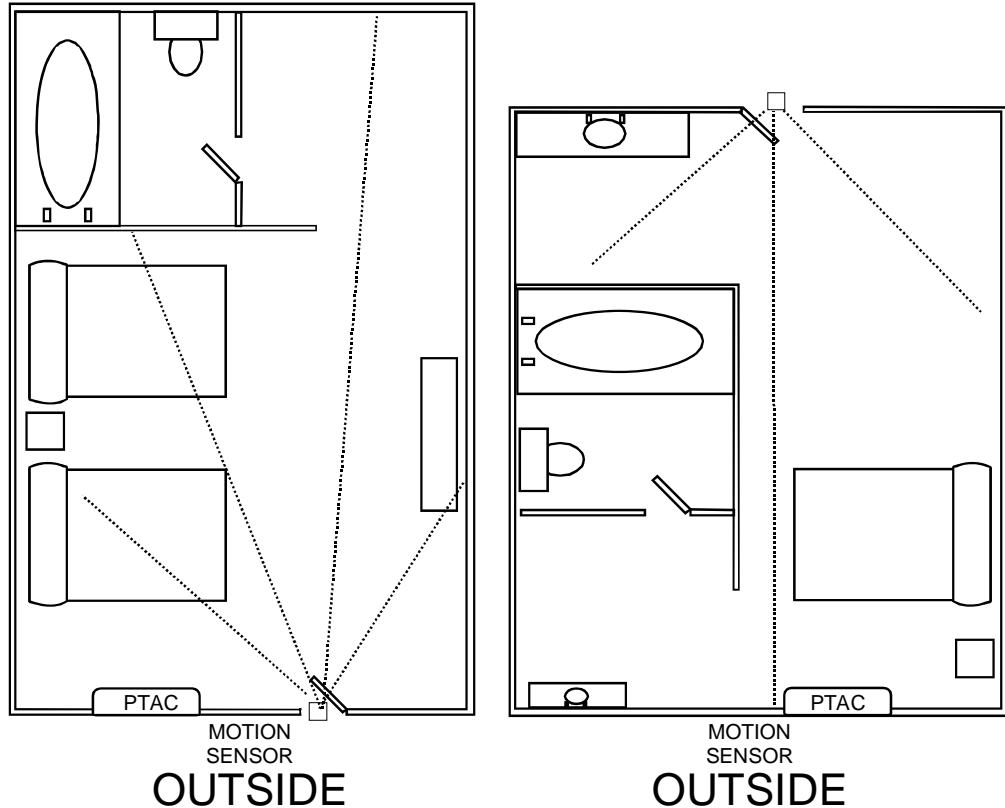

CAUTION

This equipment is authorized for use under the United States Federal Communication Commission Rules and Regulations, Code of Federal Regulations Chapter 47 part 15 and must be installed in accordance with the instructions provided in this document. Failure to install or operate this equipment as instructed in this document could void the user's authority to operate the equipment. This equipment contains no user servicable parts. Any modification or repairs to the internal components or to the antenna configuration of the equipment without the express written consent of Everex Communications, Inc. could void the user's authority to operate the equipment.

NOTE: To comply with FCC RF exposure requirements in section 1.1307, a minimum separation distance of 20cm (8 inches) is required between the equipment and all persons.

NOTE: This equipment has been tested and found to comply with the limits for a Class B digital device, pursuant to Part 15 of the FCC Rules. These limits are designed to provide reasonable protection against harmful interference in a residential installation. This equipment generates, uses and can radiate radio frequency energy and, if not installed and used in accordance with the instructions, may cause harmful interference to radio communications. However, there is no guarantee that interference will occur in a particular installation. If this equipment does cause harmful interference to radio or television reception, which can be determined by turning the equipment off and on, the user is encouraged to try to correct the interference by one or more of the following measures:

- Reorient or relocate the receiving antenna.
- Increase the separation between the equipment and receiver.
- Connect the equipment into an outlet on a circuit different from that to which the receiver is connected.
- Consult the dealer or an experienced radio/TV technician for help.