

PACKAGE TERMINAL AIR CONDITIONER (PTAC)
AND HEAT PUMP

Specifications and Accessories Catalog

Wise Decision.
It's an Amana[®] brand.



Amana is a registered trademark of Maytag Corporation or its related companies and is used under license to Goodman Company, L.P., Houston, TX, USA. All rights reserved.

Premium Amana[®]
Brand Quality

Featuring
EDEN[™]

Web-Based
Monitoring

EDEN™

A COMBINATION OF ENERGY MANAGEMENT
AND PTAC PERFORMANCE



The Amana® brand Eden™ control system brings together our best PTAC and our finest energy management software, which is now capable of integrating with optional property management and front desk management software. Reduce PTAC energy consumption up to 35% OR MORE* with features such as the in-unit energy management system, programmable temperature set-back, and temperature limiting. The Maintenance Notification System adds value by helping head off potential PTAC service issues.

AMANA BRAND EDEN SOLUTION TIERS

■ IN-ROOM - "SELF-INSTALLABLE" WIRELESS PERIPHERALS

The Eden Wireless Remote Thermostat can be mounted on the wall anywhere in the guest room. It is battery powered and capable of wireless communication with the PTAC to maintain room temperature. Best of all, there are no wires to run. The PTAC and thermostat connect at the press of a button and work in-sync to display accurate temperature.



The Eden Wireless Antenna installs inside the PTAC with a snap-in connector like a telephone jack. Installing the antenna allows the PTAC to communicate wirelessly with other devices in the room and to the Eden network.



- 60,000+ rooms have had wireless installations since 2005
- Total wireless devices deployed to date: 425,000+

The Eden Occupancy Sensor and Door Switch Combo Device completes the in-room equipment. This infrared sensor can determine when the room is occupied. When empty, it signals the PTAC to adjust the temperature based on programmable set-backs to save energy.



The Amana brand Eden PTAC with antenna, combined with the self-installable, wireless thermostat and occupancy sensor, give the property owner complete control over the equipment settings and can reduce PTAC energy usage up to **35% OR MORE.***

■ SITE-LEVEL – CENTRAL WIRELESS CONTROLLER

- Site-wide PTAC Configuration
- Site-wide PTAC Diagnostics
- Front-Desk System Interface
- Email Reporting
- Internet Accessible Web User Interface Enterprise

* These savings represent estimated savings over time as compared to the same PTAC model without the Eden EMS installed and were generated using general assumptions including energy loads, local weather averages and use of occupancy controls. Actual savings will vary according to actual use habits, room square footage, and how the unit is installed and maintained.

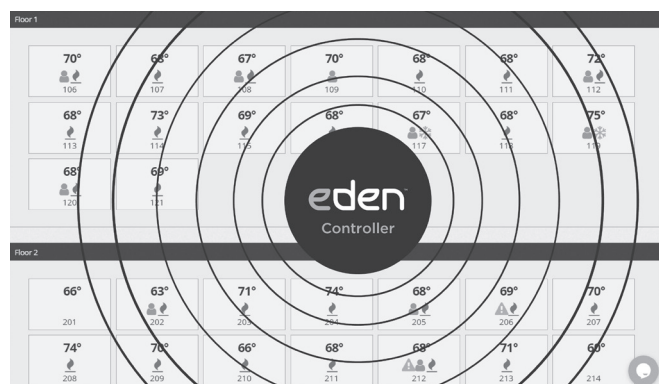

EDEN™

A COMBINATION OF ENERGY MANAGEMENT
AND PTAC PERFORMANCE

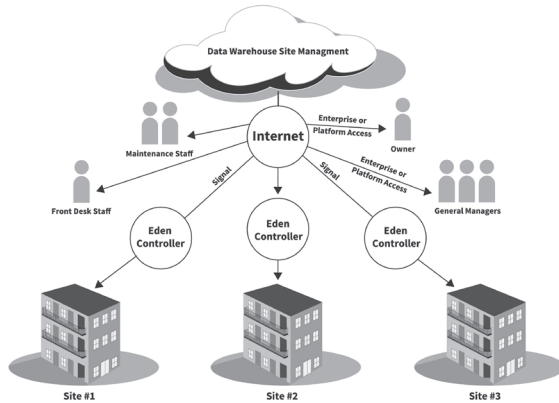

ENTERPRISE – MULTIPLE WIRELESS CONTROLLERS

Central Monitoring and Control of Multiple Properties

- Data Warehousing
- Virtual Metering
- Savings Analysis
- Load Shedding
- Email Reporting

WEB-BASED MONITORING – AMANA® BRAND EDEN™ CONTROLLER

ALL PTACS IN A BUILDING CAN BE MANAGED THROUGH A SINGLE INTERFACE ON A PC.

Features Include:

- Full unit details for every PTAC, visible from the front desk or home office
- Automatic emails for PTAC maintenance
- Ability to change all settings on the unit
- Enhanced diagnostics
- Monitors up to 250 PTACs WIRELESSLY with one controller
- Expand the network with additional controllers
 - System Verification
 - Site Statistics
 - Global Setbacks
 - Email Reporting
 - EMS Configuration
 - Unit Health
 - Site Statistics
 - Unit Code Alerts

Unrented Set-Points

By integrating with your property's Front Desk System, the PTACs will adjust to specific set-points when no longer identified as rented in the system.

Temp Limiting

Each PTAC can be configured with a heating and cooling temperature set-point limit.

Set-backs

Once a room is declared unoccupied by the occupancy sensor, the PTAC progresses through three different temperature set-backs, configured as three degree and time pairs.

Example setback configuration:

- 1. 2°, 30 mins -**
Setback the temp 2 degrees after 30 minutes
- 2. 4°, 1 hr -**
Setback the temp 2 more degrees after 30 more minutes
- 3. 8°, 3 hrs -**
Setback the temp 4 more degrees after 2 more hours

Standard Features

- **Energy Efficiencies:** With EERs up to 13.1 and COPs up to 3.6, our unit's high efficiencies may qualify you for many of the rebates offered by electrical power companies.
- **Quiet Operation:** Our PTAC has been redesigned to be the quietest PTAC we've ever built. The unit's state-of-the-art design and construction provide a quiet environment, allowing guests to enjoy peaceful, sleep-filled nights.
 - Two fan motors (indoor/outdoor)
 - Indoor tangential fan for quiet operation
 - STC of 28
- **Assembled in the USA for 40 years:** assembled at our plant in Waller, TX, using Goodman resources including engineering, production, and testing.
- **Increased Dehumidification Capacity:** Maintain lower humidity levels in rooms while cooling them without the need for expensive add-ons. As a result, guests feel more comfortable at higher temperatures, thus reducing cooling costs.
- **Seven-Button Touch Pad:** Provides complete control to guests for in-room comfort while maintaining energy efficiency.
- **Five-Year Limited Warranty:** Enjoy one of the most comprehensive warranties in the industry: First Year: parts & labor; Second through fifth years: parts & labor on certain sealed system components; second through fifth years: on certain functional parts only. For complete warranty details, visit www.amana-ptac.com.
- **100% Run Tested:** All units are 100% run tested at our plant in Fayetteville, TN, including leak checks during manufacturing and again prior to shipment at the warehouse.
- **7⁵/₈" Unit Front Depth:** Enhance valuable room space with our slim unit front, which has a sleek 7⁵/₈" depth, one of the shallowest silhouettes in the industry today. In addition, to inhibit guest-tampering, the front can be secured to the chassis with a hidden screw.
- **Easy Pull-Out Filters:** Our filters are washable and easy to maintain.
- **Filter Dryer for Sealed System Refrigerant:** Standard in all units to protect the compressor and lengthen the life of the unit by removing moisture and preventing acid formation.
- **Condensate Dispersion System:** Our condensate dispersion system removes condensate from indoor cooling operation by throwing water directly on to the outdoor coil for rapid evaporation and increased cooling efficiencies. The slinger ring on the new, enhanced fan draws water up and into the fan blades. This water is then atomized and evaporated into the atmosphere through the condenser. Increased surface area from the coil allows more water to be evaporated on the sides of the coils and helps to minimize condensate run-off.
- **Front Desk Control:** Each unit comes equipped with the EDEN™ control and energy management software. Using the EDEN™ software and optional RF Antenna, all units can be wirelessly connected to a central hub for enhanced energy savings and diagnostics. Amana brand PTACs also have a low-voltage interface capability with a field-supplied front-desk ON/OFF switch. (See inside front cover.)

- **Room Freeze Protection:** When the unit senses temperatures of 40°F or below, the unit activates the fan motor and either the electric resistance heater or the hydronic heater.
- **Easy-to-use Controls:** No complex controls to confuse your guests and create phone calls for your manager. Controls are easy to read, understand, and activate. Our new 7-button control panel provides guests with complete control of the unit for their in-room comfort while maintaining overall energy efficiency.
- **Easy to Service with On-Board LED Diagnostics:** The main components are easily serviced and there is no guessing to determine the problem with our easy-to-read diagnostics.
- **Stonewood Room Front:** Our Stonewood room front strikes the balance between attractive styling and practical design. Distinctive contours and a modern appearance enhance the character of even the most luxurious room, while the sleek 7 $\frac{5}{8}$ " depth maximizes usable space for your guests.
- **Remote Thermostat Control:** When the Eden™ wireless remote thermostat (DS01G, sold separately) is set up, both the remote thermostat and unit control panel continue to control the unit, providing flexibility and home-like system control. Installation requires no more than pressing two buttons. No need to run wires or make electrical connections.
- **Zero Floor Clearance:** The unit can be installed flush to a finished floor, if desired. (Some accessories do not have zero clearance).
- **30-Second Fan-Off Delay:** The fan continues to run 30 seconds after the compressor has stopped in either cooling or heat pump mode and after electric heat has been turned off. This improves efficiency by dispersing the conditioned air on the coils into the room.
- **Compressor Lock-In:** This feature helps prolong the life of the compressor by preventing short-cycling. When the compressor is switched from Off to On because room temperature has risen or fallen below the specified limit, it will remain on for at least 4 minutes. If the temperature set-point is changed during this 4 minutes, the lock-in feature is overridden.
- **Automatic Emergency Heat:** No more “my unit is not heating” complaints during the middle of the night. Heat pump units will automatically switch over to electric resistance heat if the heat pump compressor system fails or if the heating load is greater than the unit capacity.
- **Constant Fan Mode:** Take advantage of each unit’s dual options — select continuous fan operation or cycle the fan ON and OFF with the thermostat. Our 7-button design allows guests to select fan performance while allowing the owner to have the unit revert to the desired program of continuous fan or cycle with conditioning.
- **Hidden Ventilation Control:** The ventilation control lever is hidden from the occupant's view to allow you to manage ventilation requirements.
- **High-Pressure Switch:** Protects the unit from high pressure and damage to the unit, helping to ensure long unit life.

Nomenclature

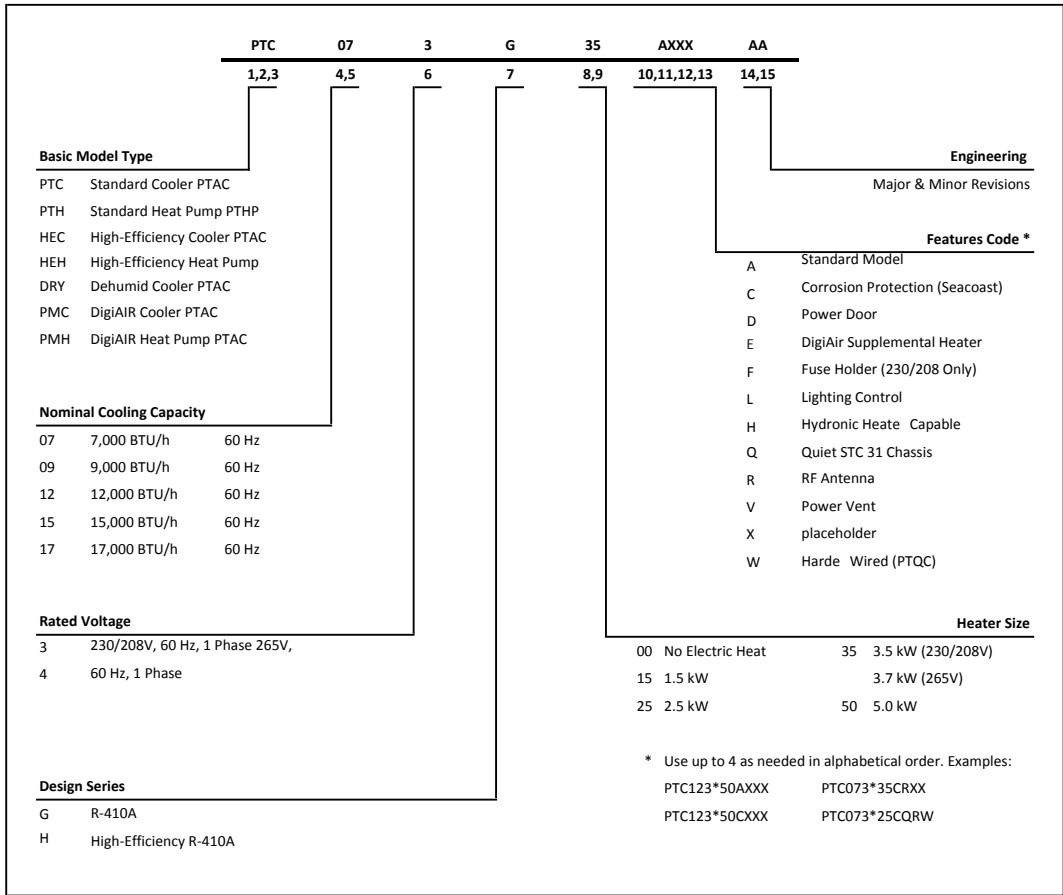

Power Cord Configuration

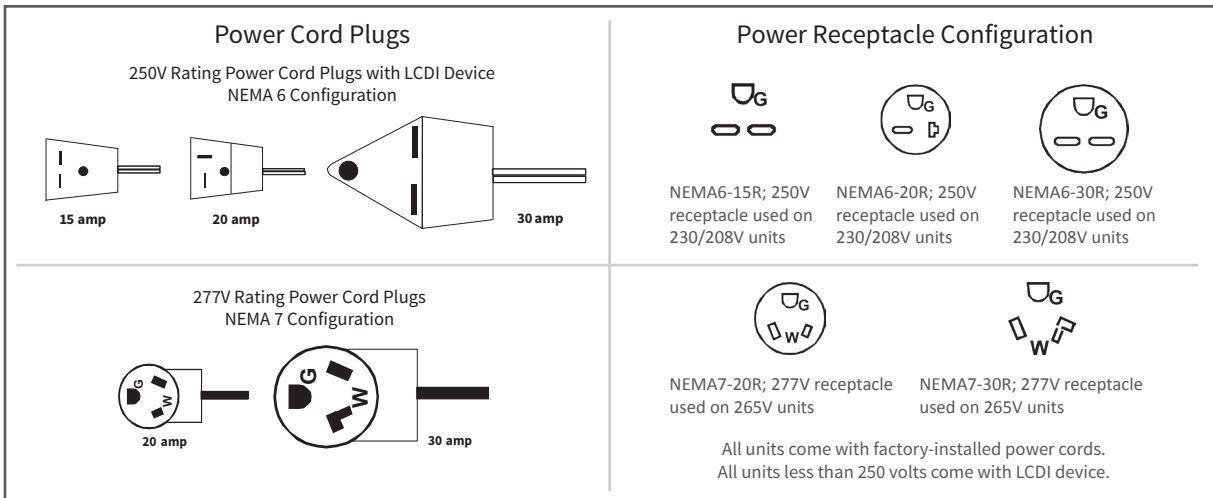

Product Specifications: PTC Models — Cooling/Electric Heat

230/208 Volts						
Model ^{6,8,9}		PTC 073G***XXX	PTC 093G***XXX	PTC 123G***XXX	PTC 153G***XXX	PTC 173G***XXX
Voltage ³		230 / 208	230 / 208	230 / 208	230 / 208	230 / 208
Capacity (BTU/h)		7,000 / 7,000	9,200 / 9,000	11,900 / 11,700	14,800 / 14,500	16,700 / 16,400
Amps ¹⁰		3.1 / 3.1	4.1 / 4.1	5.0 / 5.0	7.0 / 7.0	8.4
Watts ¹⁰		580 / 560	790 / 765	1045 / 1035	1,500 / 1,470	1,725 / 1,705
EER		12.0 / 12.5	11.6 / 11.7	11.0 / 11.0	10.0 / 10.0	9.5 / 9.5
Unit without Electric Heater						
Min. Circuit Amps ^{2,4,10}		3.7	5.0	6.1	8.5	10.2
CFM (Cool/Wet Coil)	High	290	290	290	340	340
	Low	264	264	264	314	314
CFM (Dry Coil)	High	310	310	310	360	360
	Low	282	282	282	332	332
Ventilated Air, CFM (Fan Only)*		65*	65*	65*	65*	65*
Dehumidification (Pints/Hr.)		1.7	2.2	3.6	4.4	4.8
Net Weight (lbs.)		98	102	102	113	113
Ship Weight (lbs.)		113	117	119	130	130

265/277 Volts					
Model ^{1,6,8}		PTC074G ***XXX	PTC094G ***XXX	PTC124G ***XXX	PTC154G ***XXX
Voltage ^{1,3}		265	265	265	265
Capacity (BTU/h)		7,000	9,100	12,200	14,800
Amps ¹⁰		3.0	3.6	4.8	6.0
Watts ¹⁰		658	796	1,154	1,480
EER		11.9	11.3	10.4	10.0
Unit without Electric Heater					
Min. Circuit Amps ^{2,4,10}		3.6	4.4	5.9	7.4
CFM (Cool/Wet Coil)	High	290	290	290	340
	Low	264	264	264	314
CFM (Dry Coil)	High	310	310	310	360
	Low	282	282	282	332
Ventilated Air, CFM (Fan Only)*		65*	65*	65*	65*
Dehumidification (Pints/Hr.)		1.7	2.2	3.6	4.4
Net Weight (lbs.)		98	102	102	113
Ship Weight (lbs.)		113	117	119	130

* Actual vent CFM performance will vary due to application and installation conditions.

NOTES

- ¹ All 265-volt models must use an Amana® brand sub-base (PTSB4**E) or an Amana® brand hard-wire kit PTPWHWK4 and disconnect switch PSHW04A.
- ² Minimum Circuit Ampacity (MCA) ratings conform to the National Electric Code; however, local codes should apply.
- ³ Minimum voltage on 230/208-volt models is 197 volts; maximum is 253 volts. Minimum voltage on 265-volt models is 239 volts; maximum is 292 volts.
- ⁴ Overcurrent protection for all units without electric heaters is 15 amps. Overcurrent protection on 265-volt models must be cartridge-style time-delay fuses (included and factory-installed on all Amana® brand 265-volt chassis). See heater performance
- ⁵ Heating capacity and efficiency based on unit operation without condensate pump.
- ⁶ Specify two-digit heater kW size to complete model number.
- ⁷ R-410A refrigerant used in all systems.
- ⁸ All units meet or exceed ASHRAE 90.1 standards.
- ⁹ All units less than 250 volts have a Leak Current Detector Interrupter (LCDI) power cord and meet UL 484 standards.
- ¹⁰ Refer to electric heat performance data for total MCA and recommended overcurrent protection. Amps and Watts notation refers to compressor only.

Product Specifications: HEC Models — Cooling/Electric Heat

230/208 Volts							
Model ^{6, 8, 9}	HEC 073H***XXX	HEC 093H***XXX	HEC 123H***XXX	HEC 153H***XXX	HEC 094H***XXX	HEC 124H***XXX	
Voltage ³	230 / 208	230 / 208	230 / 208	230 / 208	265	265	
Capacity (BTU/h)	7,000 / 7,000	9,200 / 9,000	11,900 / 11,700	14,800 / 14,500	9,100	12,200	
Amps ¹⁰	3.6 / 3.6	4.6 / 4.6	5.5 / 5.5	7.3 / 7.3	4.1	5.3	
Watts ¹⁰	535 / 555	750 / 770	990 / 1025	1,470 / 1,440	765	1,120	
EER	12.6 / 13.0	11.8 / 11.9	11.3 / 11.5	10.2 / 10.2	11.7	10.7	
Unit without Electric Heater							
Min. Circuit Amps ^{2, 4, 10}	4.2	5.5	6.6	7.3	4.8	6.3	
CFM (Cool/Wet Coil)	High	340	330	340	340	290	390
	Low	245	245	245	245	264	264
CFM (Dry Coil)	High	370	360	370	370	310	310
	Low	270	270	270	270	282	282
Ventilated Air, CFM (Fan Only)*	65*	65*	65*	65*	65*	65*	
Dehumidification (Pints/Hr.)	1.7	2.2	3.6	4.1	2.2	3.6	
Net Weight (lbs.)	97	101	102	113	102	102	
Ship Weight (lbs.)	112	116	118	130	117	119	

* Actual vent CFM performance will vary due to application and installation conditions.

NOTES

- ¹ All 265-volt models must use an Amana® brand sub-base (PTSB4**E) or an Amana® brand hard-wire kit PTPWHWK4 and disconnect switch PSHW04A.
- ² Minimum Circuit Ampacity (MCA) ratings conform to the National Electric Code; however, local codes should apply.
- ³ Minimum voltage on 230/208-volt models is 197 volts; maximum is 253 volts. Minimum voltage on 265-volt models is 239 volts; maximum is 292 volts.
- ⁴ Overcurrent protection for all units without electric heaters is 15 amps. Overcurrent protection on 265-volt models must be cartridge-style time-delay fuses (included and factory-installed on all Amana® brand 265-volt chassis). See heater performance.
- ⁵ Heating capacity and efficiency based on unit operation without condensate pump.
- ⁶ Specify two-digit heater kW size to complete model number.
- ⁷ R-410A refrigerant used in all systems.
- ⁸ All units meet or exceed ASHRAE 90.1 standards.
- ⁹ All units less than 250 volts have a Leak Current Detector Interrupter (LCDI) power cord and meet UL 484 standards.
- ¹⁰ Refer to electric heat performance data for total MCA and recommended overcurrent protection. Amps and Watts notation refers to compressor only.

Product Specifications: PTH Models — Cooling/Heat Pump/Electric Heat

MODEL ^{1, 6, 8, 9}	PTH073G **AXXX	PTH093G **AXXX	PTH123G **AXXX	PTH153G **AXXX	PTH074G **AXXX	PTH094G **AXXX	PTH124G **AXXX	PTH154G **AXXX
Voltage ^{1, 3}	230 / 208	230 / 208	230 / 208	230 / 208	265	265	265	265
Capacity (BTU/h)	7,100 / 7,000	9,000 / 9,000	11,600 / 11,400	14,200 / 14,000	7,600	9,100	12,000	14,600
Amps ¹⁰	3.9 / 3.9	4.2 / 4.2	5.8 / 5.8	7.0 / 7.0	3.1	3.7	5.0	6.1
Watts ¹⁰	650 / 633	750 / 750	1,090 / 1,090	1,515 / 1,515	650	758	1,091	1,505
EER	12.0 / 12.4	11.9 / 12.0	11.0 / 11.1	9.9 / 9.9	11.7	12.0	11.0	9.7
UNIT WITHOUT ELECTRIC HEATER								
Min. Circuit Amps ^{2, 4, 10}	4.7	5.1	7.1	8.5	3.8	4.5	6.1	7.4
CFM (Cool/Wet Coil)	High	340	330	340	390	340	330	340
	Low	245	245	245	340	245	245	245
CFM (Dry Coil)	High	370	360	370	410	370	360	370
	Low	270	270	270	370	270	270	270
Ventilated Air, CFM (Fan Only)*	65*	65*	65*	65*	65*	65*	65*	65*
Dehumidification (Pints/Hr.)	1.7	2.2	3.6	4.4	1.7	2.2	3.6	4.4
Net Weight (lbs.)	108	112	115	126	108	112	115	125
Ship Weight (lbs.)	123	127	132	143	123	127	132	142

* Actual vent CFM performance will vary due to application and installation conditions.

NOTES

- ¹ All 265-volt models must use an Amana® brand sub-base (PTSB4**E) or an Amana® brand hard-wire kit PTPWHWK4 and disconnect switch PSHW04A.
- ² Minimum Circuit Ampacity (MCA) ratings conform to the National Electric Code; however, local codes should apply.
- ³ Minimum voltage on 230/208-volt models is 197 volts; maximum is 253 volts. Minimum voltage on 265-volt models is 239 volts; maximum is 292 volts.
- ⁴ Overcurrent protection for all units without electric heaters is 15 amps. Overcurrent protection on 265-volt models must be cartridge-style time-delay fuses (included and factory-installed on all Amana® brand 265-volt chassis). See heater performance
- ⁵ Heating capacity and efficiency based on unit operation without condensate pump.
- ⁶ Specify two-digit heater kW size to complete model number.
- ⁷ R-410A refrigerant used in all systems.
- ⁸ All units meet or exceed ASHRAE 90.1 standards.
- ⁹ All units less than 250 volts have a Leak Current Detector Interrupter (LCDI) power cord and meet UL 484 standards.
- ¹⁰ Refer to electric heat performance data for total MCA and recommended overcurrent protection. Amps and Watts notation refers to compressor only.

Product Specifications: HEH Models (High-Efficiency Heat Pumps) — Cooling/Heat Pump/Electric Heat

MODEL ^{1, 6, 8, 9}	HEH073H **AXXX	HEH093H **AXXX	HEH123H **AXXX	HEH153H ***XXX	HEH074H **AXXX	HEH094H **AXXX	HEH124H **AXXX	HEH154H ***XXX	
Voltage ^{1, 3}	230 / 208	230 / 208	230 / 208	230 / 208	265	265	265	265	
Capacity (BTU/h)	7,100 / 7,000	9,000 / 9,000	11,600 / 11,400	14,200 / 14,000	7,700	9,100	12,000	14,400	
Amps ¹⁰	4.1 / 4.1	4.7 / 4.7	6.2 / 6.2	7.4 / 7.4	3.6	4.2	5.4	6.4	
Watts ¹⁰	595 / 595	720 / 720	1,040 / 1,040	1,440 / 1,440	595	730	1,040	1,430	
EER	13.0 / 13.3	12.7 / 12.7	11.5 / 11.5	10.2 / 10.2	12.4	12.4	11.5	10.0	
UNIT WITHOUT ELECTRIC HEATER									
Min. Circuit Amps ^{2, 4, 10}	5.4	5.4	5.4	8.9	3.6	3.6	3.6	7.8	
CFM (Cool/Wet Coil)	High	340	330	340	390	340	330	340	390
	Low	245	245	245	340	245	245	245	340
CFM (Dry Coil)	High	370	360	370	410	370	360	370	410
	Low	270	270	270	370	270	270	270	370
Ventilated Air, CFM (Fan Only)*	65*	65*	65*	65*	65*	65*	65*	65*	
Dehumidification (Pints/Hr.)	1.7	2.2	3.6	4.1	1.7	2.2	3.6	4.1	
Net Weight (lbs.)	107	111	114	125	107	111	114	125	
Ship Weight (lbs.)	122	126	131	142	122	126	131	142	

* Actual vent CFM performance will vary due to application and installation conditions.

NOTES

¹ All 265-volt models must use an Amana® brand sub-base (PTSB4**E) or an Amana® brand hard-wire kit (PTPWHWK4).

² Minimum Circuit Ampacity (MCA) ratings conform to the National Electric Code; however, local codes should apply. Minimum voltage on 230/208-volt models is 197 volts; maximum is 253 volts.

³ Minimum voltage on 265-volt models is 239 volts; maximum is 292 volts.

⁴ Overcurrent protection for all units without electric heaters is 15 amps. Overcurrent protection on 265-volt models must be cartridge-style time-delay fuses (included and factory-installed on all Amana® brand 265-volt chassis).

⁵ Heating capacity and efficiency based on unit operation without condensate pump.

⁶ Specify two-digit heater kW size to complete model number.

⁷ R-410A refrigerant used in all systems.

⁸ All units meet or exceed ASHRAE 90.1 standards.

⁹ All units less than 250 volts have a Leak Current Detector Interrupter (LCDI) power cord and meet UL 484 standards.

¹⁰ Refer to electric heat performance data for total MCA and recommended overcurrent protection. Amps and Watts notation refers to compressor only.

Product Specifications: PMC Models — Cooling/Electric Heat

230/208 Volts					
Model ^{6,8,9}		PMC 073G***XXX	PMC 093G***XXX	PMC 123G***XXX	PMC 153G***XXX
Voltage ³		230 / 208	230 / 208	230 / 208	230 / 208
Capacity (BTU/h)		6,700 / 6,800	8,700 / 9,000	11,800 / 11,700	14,500 / 14,400
Amps ¹⁰		3.3 / 3.3	4.3 / 4.3	5.2 / 5.2	7.0 / 7.0
Watts ¹⁰		570 / 560	785 / 760	1,060 / 1,055	1,575 / 1,530
EER		12.0 / 12.1	11.6 / 11.4	11.0 / 11.0	9.9 / 9.9
Unit without Electric Heater					
Min. Circuit Amps ^{2,4,10}		4.9	6.2	7.3	9.6
CFM (Cool/Wet Coil)	High	290	290	290	340
	Low	264	264	264	314
CFM (Dry Coil)	High	310	310	310	360
	Low	282	282	282	332
Ventilated Air, CFM (Fan Only)*		65*	65*	65*	65*
Dehumidification (Pints/Hr.)		1.7	2.2	3.6	4.4
Net Weight (lbs.)		118	122	122	133
Ship Weight (lbs.)		133	137	137	148

* Actual vent CFM performance will vary due to application and installation conditions.

NOTES

- ¹ All 265-volt models must use an Amana® brand sub-base (PTSB4**E) or an Amana® brand hard-wire kit PTPWHWK4 and disconnect switch PSHW04A.
- ² Minimum Circuit Ampacity (MCA) ratings conform to the National Electric Code; however, local codes should apply.
- ³ Minimum voltage on 230/208-volt models is 197 volts; maximum is 253 volts. Minimum voltage on 265-volt models is 239 volts; maximum is 292 volts.
- ⁴ Overcurrent protection for all units without electric heaters is 15 amps. Overcurrent protection on 265-volt models must be cartridge-style time-delay fuses (included and factory-installed on all Amana® brand 265-volt chassis). See heater performance
- ⁵ Heating capacity and efficiency based on unit operation without condensate pump.
- ⁶ Specify two-digit heater kW size to complete model number.
- ⁷ R-410A refrigerant used in all systems.
- ⁸ All units meet or exceed ASHRAE 90.1 standards.
- ⁹ All units less than 250 volts have a Leak Current Detector Interrupter (LCDI) power cord and meet UL 484 standards.
- ¹⁰ Refer to electric heat performance data for total MCA and recommended overcurrent protection. Amps and Watts notation refers to compressor only.

Product Specifications: PMH Models — Cooling/Heat Pump/Electric Heat

230/208 Volts					
Model ^{6, 8, 9}		PMH 073G***XXX	PMH 093G***XXX	PMH 123G***XXX	
Voltage ³		230 / 208	230 / 208	230 / 208	
Capacity (BTU/h)		6,900 / 6,700	8,700 / 8,700	11,400 / 11,200	
Amps ¹⁰		3.7 / 3.7	4.1 / 4.1	5.7 / 5.7	
Watts ¹⁰		640 / 640	795 / 795	1,150 / 1,150	
EER		11.9 / 12.0	11.7 / 11.8	10.8 / 11.0	
Unit without Electric Heater					
Min. Circuit Amps ^{2, 4, 10}		5.4	6.0	8.0	
CFM (Cool/Wet Coil)	High	340	330	340	
	Low	245	245	245	
CFM (Dry Coil)	High	370	360	370	
	Low	270	270	270	
Ventilated Air, CFM (Fan Only)*		65*	65*	65*	
Dehumidification (Pints/Hr.)		1.7	2.2	3.6	
Net Weight (lbs.)		128	132	135	
Ship Weight (lbs.)		143	147	150	

265 Volts					
Model ^{1, 6, 8}		PMH 074G***XXX	PMH 094G***XXX	PMH 124G***XXX	
Voltage ^{1, 3}		265	265	265	
Capacity (BTU/h)		7,700	9,000	12,000	
Amps ¹⁰		3.2	4.2	5.1	
Watts ¹⁰		655	775	1150	
EER		11.7	11.6	10.4	
Unit without Electric Heater					
Min. Circuit Amps ^{2, 4, 10}		4.9	6.0	7.2	
CFM (Cool/Wet Coil)	High	340	330	340	
	Low	245	245	245	
CFM (Dry Coil)	High	370	360	370	
	Low	270	270	270	
Ventilated Air, CFM (Fan Only)*		65	65	65	
Dehumidification (Pints/Hr.)		1.7	2.2	3.6	
Net Weight (lbs.)		128	132	135	
Ship Weight (lbs.)		143	147	150	

* Actual vent CFM performance will vary due to application and installation conditions.

NOTES

- ¹ All 265-volt models must use an Amana® brand sub-base (PTSB4**E) or an Amana® brand hard-wire kit PTPWHWK4 and disconnect switch PSHW04A.
- ² Minimum Circuit Ampacity (MCA) ratings conform to the National Electric Code; however, local codes should apply.
- ³ Minimum voltage on 230/208-volt models is 197 volts; maximum is 253 volts. Minimum voltage on 265-volt models is 239 volts; maximum is 292 volts.
- ⁴ Overcurrent protection for all units without electric heaters is 15 amps. Overcurrent protection on 265-volt models must be cartridge-style time-delay fuses (included and factory-installed on all Amana® brand 265-volt chassis). See heater performance
- ⁵ Heating capacity and efficiency based on unit operation without condensate pump.
- ⁶ Specify two-digit heater kW size to complete model number.
- ⁷ R-410A refrigerant used in all systems.
- ⁸ All units meet or exceed ASHRAE 90.1 standards.
- ⁹ All units less than 250 volts have a Leak Current Detector Interrupter (LCDI) power cord and meet UL 484 standards.
- ¹⁰ Refer to electric heat performance data for total MCA and recommended overcurrent protection. Amps and Watts notation refers to compressor only.

Product Specifications: All Models — Electric Heat Performance

(Primary Heating for PTC, HEC, PMC Models; Auxiliary Heating for PTH, HEH, PMH Models; See below for Power Cord Configuration)

VOLTAGE	ELECTRIC HEATER SIZE (kW)	NO. OF STAGES	NOMINAL HEATING (BTU/H)			TOTAL WATTS ⁶	TOTAL AMPS	MIN. CIRCUIT AMPACITY ²	MOP ⁴ (AMPS)	POWER CORD
			@ 230V	@ 208V	@ 265V					
230/208V	1.5 / 1.2	1	5,100	4,200	--	1,570 / 1,295	6.8 / 6.2	8.5	15	6-15 P
230/208V	2.5 / 2.1	1	8,500	6,800	--	2,570 / 2,115	11.2 / 10.1	14.1	15	6-15 P
230/208V	3.5 / 2.9	1	12,000	9,900	--	3,570 / 2,935	15.5 / 14.1	19.5	20	6-20 P
230/208V	5.0 / 4.1	1	17,100	14,000	--	5,070 / 4,160	22.1 / 20.0	27.6	30	6-30 P
265V	1.5	1	--	--	5,100	1,570	5.9	7.4	15	7-20P
265V	2.5	1	--	--	8,500	2,570	9.7	12.2	15	7-20 P
265V	3.7	1	--	--	12,600	3,770	14.2	17.9	20	7-20 P
265V	5	1	--	--	17,100	5,070	19.2	23.9	25	7-30 P

NOTES

- ¹ All 265-volt models must use an Amana® brand sub-base (PTSB4**E) or an Amana® brand hard-wire kit (PTPWHWK4).
- ² Minimum branch circuit ampacity ratings conform to the National Electric Code; however, local codes should apply.
- ³ Minimum voltage on 230/208-volt models is 197 volts; maximum is 253 volts. Minimum voltage on 265-volt models is 239 volts; maximum is 292 volts.
- ⁴ Overcurrent protection for all units without electric heaters is 15 amps. Overcurrent protection on 265-volt models must be cartridge-style time-delay fuses (included and factory-installed on all Amana® brand 265-volt chassis).
- ⁵ Heating capacity and efficiency based on unit operation without condensate pump.
- ⁶ Total watts for 15,000 BTU/h models; subtract 20 watts for PT07/09/12
- ⁷ Specify two-digit heater kW size to complete model number.
- ⁸ R-410A refrigerant used in all systems.
- ⁹ All units meet or exceed ASHRAE 90.1 standards.
- ¹⁰ All units less than 250 volts have a Leak Current Detector Interrupter (LCDI) power cord and meet UL 484 standards.

Product Specifications: PTH Models — Reverse-Cycle Heating Performance

HEATING CAPACITY ¹	PTH073G **AXXX	PTH074G **AXXX	PTH093G **AXXX	PTH094G **AXXX	PTH123G **AXXX	PTH124G **AXXX	PTH153G **AXXX	PTH154G **AXXX
Voltage ^{1, 3}	230 / 208	265	230 / 208	265	230 / 208	265	230 / 208	265
BTU/h ⁵	6,500 / 6,400	6,800	8,200 / 8,000	8,300	10,600 / 10,500	11,300	13,900 / 13,700	13,700
Amps ¹⁰	3.9 / 3.9	3.1	4.2 / 4.2	3.7	5.8 / 5.8	5	7.0/7.0	6.1
Watts ¹⁰	585 / 585	585	715 / 700	715	1,085 / 1,035	1,080	1,350 / 1,330	1,340
COP ⁵	3.5 / 3.4	3.4	3.4 / 3.4	3.4	3.2 / 3.2	3.1	3.0/3.0	3
CFM (Dry)	370	370	360	360	370	370	410	410

NOTES

- ¹ All 265-volt models must use an Amana® brand sub-base (PTSB4**E) or an Amana® brand hard-wire kit (PTPWHWK4).
- ² Minimum branch circuit ampacity ratings conform to the National Electric Code; however, local codes should apply.
- ³ Minimum voltage on 230/208-volt models is 197 volts; maximum is 253 volts. Minimum voltage on 265-volt models is 239 volts; maximum is 292 volts.
- ⁴ Overcurrent protection for all units without electric heaters is 15 amps. Overcurrent protection on 265-volt models must be cartridge-style time-delay fuses (included and factory-installed on all Amana® brand 265-volt chassis).
- ⁵ Heating capacity and efficiency based on unit operation without condensate pump.
- ⁶ Specify two-digit heater kW size to complete model number.
- ⁷ R-410A refrigerant used in all systems.
- ⁸ All units meet or exceed ASHRAE 90.1 standards.
- ⁹ All units less than 250 volts have a Leak Current Detector Interrupter (LCDI) power cord and meet UL 484 standards.
- ¹⁰ Refer to electric heat performance data for total MCA and recommended overcurrent protection.
Amps and Watts notation refers to compressor only.

Product Specifications: HEH Models — Reverse-Cycle Heating Performance

HEATING CAPACITY ¹	HEH073H **AXXX	HEH074H **AXXX	HEH093H **AXXX	HEH094H **AXXX	HEH123H **AXXX	HEH124H **AXXX	HEH153H ***XXX	HEH154H ***XXX
Voltage ^{1, 3}	230 / 208	265	230 / 208	265	230 / 208	265	230 / 208	265
BTU/h ⁵	6,500 / 6,400	6,800	8,200 / 8,000	8,300	10,600 / 10,500	11,400	13,900 / 13,700	13,700
Amps ¹⁰	4.1 / 4.1	3.6	4.7 / 4.7	4.2	6.2 / 6.2	5.4	7.4 / 7.4	6.4
Watts ¹⁰	600 / 600	600	735 / 715	735	1,085 / 1,065	1,075	14,400 / 14,400	1,430
COP ⁵	3.8 / 3.7	3.6	3.6 / 3.6	3.5	3.3 / 3.3	3.2	3.1 / 3.1	3.1
CFM (Dry)	360	360	370	370	370	370	410	410

NOTES

- ¹ All 265-volt models must use an Amana® brand sub-base (PTSB4**E) or an Amana® brand hard-wire kit (PTPWHWK4).
- ² Minimum branch circuit ampacity ratings conform to the National Electric Code; however, local codes should apply.
- ³ Minimum voltage on 230/208-volt models is 197 volts; maximum is 253 volts. Minimum voltage on 265-volt models is 239 volts; maximum is 292 volts.
- ⁴ Overcurrent protection for all units without electric heaters is 15 amps. Overcurrent protection on 265-volt models must be cartridge-style time-delay fuses (included and factory-installed on all Amana® brand 265-volt chassis).
- ⁵ Heating capacity and efficiency based on unit operation without condensate pump.
- ⁶ Specify two-digit heater kW size to complete model number.
- ⁷ R-410A refrigerant used in all systems.
- ⁸ All units meet or exceed ASHRAE 90.1 standards.
- ⁹ All units less than 250 volts have a Leak Current Detector Interrupter (LCDI) power cord and meet UL 484 standards.
- ¹⁰ Refer to electric heat performance data for total MCA and recommended overcurrent protection.
Amps and Watts notation refers to compressor only.

Product Specifications: PMH Models — Reverse-Cycle Heating Performance (cont.)

HEATING CAPACITY ^{1,2,6,7,8,9}	PMH073G **EXXX	PMH074G **EXXX	PMH093G **EXXX	PMH094G **EXXX	PMH123G **EXXX	PMH124G **EXXX
Voltage ^{3,4}	230/208	265	230/208	265	230/208	265
BTU/h ⁵	6,200 / 6,100	6,700	7,800 / 7,600	8,000	10,600 / 10,400	11,300
Amps ¹⁰	3.6 / 3.4	3.2	4.3/4.3	4.2	5.9/5.9	5.1
Watts ¹⁰	600/600	595	735/715	710	1,085/1,065	1,065
COP ⁵	3.3/3.3	3.3	3.4 / 3.4	3.3	3.1/3.1	3.1
CFM (Dry)	360	360	360	360	360	360

COP = Coefficient of Performance; per ARI Test Procedures, units are rated for capacities and efficiencies.

NOTES

- ¹ All 265-volt models must use an Amana® brand sub-base (PTSB4**E) or an Amana® brand hard-wire kit (PTPWHWK4).
- ² Minimum branch circuit ampacity ratings conform to the National Electric Code; however, local codes should apply.
- ³ Minimum voltage on 230/208-volt models is 197 volts; maximum is 253 volts.
Minimum voltage on 265-volt models is 238.5 volts; maximum is 291.5 volts.
- ⁴ Overcurrent protection for all units without electric heaters is 15 amps. Overcurrent protection on 265-volt models must be cartridge-style time-delay fuses (included and factory-installed on all Amana® brand 265-volt chassis).
- ⁵ Heating capacity and efficiency based on unit operation without condensate pump;
- ⁶ Specify two-digit heater kW size to complete model number.
- ⁷ R-410A refrigerant used in all systems.
- ⁸ All units meet or exceed ASHRAE 90.1 standards.
- ⁹ All units less than 250 volts have a Leak Current Detector Interrupter (LCDI) power cord and meet UL 484 standards.
- ¹⁰ Refer to electric heat performance data for total MCA and recommended overcurrent protection.
Amps and Watts notation refers to compressor only

Accessories

WALL SLEEVES

All our wall sleeves have industry standard dimensions of 42" wide x 16¹/₁₆" high. The WS900E, SC and INTERNAL 14¹/₈" depth is the industry standard. Sleeves may be shipped separately to allow for installation during construction.

STANDARD-DEPTH SLEEVES

WS900E	Standard PTAC sleeve
WS900SC	Seacoast triple protected
WS900GS	Heavy Sound Isolation Insulation Sleeve
W900E-STC	.058" Extra heavy gauge steel PTAC wall sleeve with heavy sound isolation insulation
WS900D-INTERNAL	Internal drain only for window-wall installations (DK900D sold separately)
WS900E-H58	.058" Extra heavy gauge steel PTAC wall sleeve

EXTRA DEEP SLEEVES: in several depths for thicker wall installations or special room configurations

WS9XXD1	Collapsible and disassembled for efficient shipping. 16" to 24" in 1" increments. Also available in 28", 30", 32", 36", and 40"
WS9XXD-CFA	Collapsible and Fully Assembled. 16" to 24" in 1" increments. Also available in 28", 30", 32", 36", and 40"
WS9XXD-INT-C	Collapsible and disassembled for efficient shipping. Extra deep internal drain only for window wall installations.
WS9XXD-INT-CFA	Collapsible and Fully Assembled. Extra deep internal drain only for window wall installations.

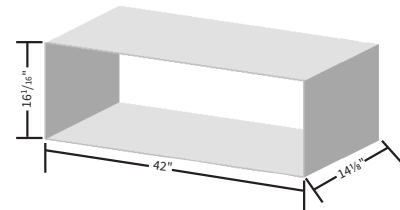

OUTDOOR GRILLES

Available in stamped-aluminum or architecturally louvered for application with an Amana brand WS900E wall sleeve.

AGK: Extruded aluminum architectural grille available with anodized aluminum finish or a baked-on paint finish for durability. Choose from 3 stock colors or a custom color to blend with your building's exterior color scheme. Colors include:
 CB (Clear Anodized), DB (Dark Brown/Bronze)
 TB (Stonewood Beige), WB (White),
 SB (Special/Custom Colors)

PGK: One-piece injection molded grille using a polymer blend of engineered thermoplastic high-impact strength material with chemical resistance and an exterior UV protective coating.

Choose from 3 stock colors:

DB (Dark Brown/Bronze), TB (Stonewood Beige), WB (White)

STANDARD OUTDOOR GRILLE

SGK01B	Single Pack
SGK01TB	Stonewood Beige

ARCHITECTURAL OUTDOOR GRILLE

AGK01CB	Anodized Aluminum
AGK01DB	Dark Bronze/Brown
AGK01TB	Stonewood Beige
AGK01WB	Amana White
AGK01SB	Custom Colors
PGK01DB	Dark Bronze/Brown
PGK01TB	Stonewood Beige
PGK01WB	Amana White

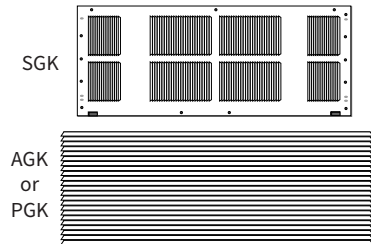

CONDENSATE DRAIN KIT

Attaches to the wall sleeve base pan for controlled internal or external disposal of condensate.

DK900D	Condensate Drain Kit (use with WS900E)
DK9001D	Condensate Drain Kit (use with WS900B)

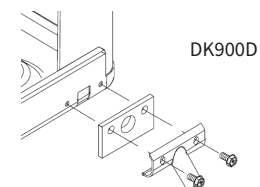



LOW-VOLTAGE WIRE HARNESS KIT (NOT SHOWN)

For quick connections of the remote, or wired, thermostats, wired EMS, or front desk with jumpers and connectors.

PWHK01C	Wire Harness Kit
---------	------------------

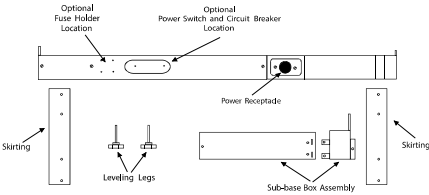
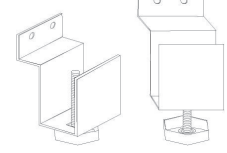
Accessories (cont.)

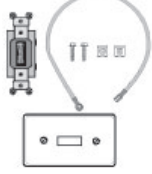
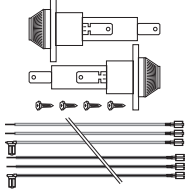
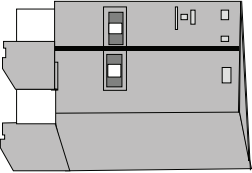
<p>REMOTE ESCUTCHEON KIT (NOT SHOWN) Optional kit for use with units controlled via a wired, remote thermostat. Covers control touch-pad for wired thermostat installations.</p>	<table border="1"> <tr> <td>REK10B</td> <td>Remote Escutcheon Kit (10-pack)</td> </tr> <tr> <td>REK10A</td> <td>Remote Escutcheon Plates</td> </tr> </table>	REK10B	Remote Escutcheon Kit (10-pack)	REK10A	Remote Escutcheon Plates	<p>Each “B” kit contains 80 wires and wire nuts, enough to attach a thermostat and one additional accessory to 10 PTAC units. Wires come in assorted colors for easy attachment. Each “A” kit contains 10 Escutcheon plates only.</p>								
REK10B	Remote Escutcheon Kit (10-pack)													
REK10A	Remote Escutcheon Plates													
<p>SUB-BASE KIT The fully skirted sub-base conceals wiring while providing strong support, if needed. Plug-in receptacle and field-wiring access speeds installation. Electrical accessories, such as fuse holders, circuit breakers and disconnect switches, meet N.E.C. requirements.</p>	<table border="1"> <tr> <td>PTSB215E</td> <td>115V/15A</td> </tr> <tr> <td>PTSB320E</td> <td>230/208V 15/20A</td> </tr> <tr> <td>PTSB330E</td> <td>230/208V 30A</td> </tr> <tr> <td>PTSB420E</td> <td>265V 15/20A</td> </tr> <tr> <td>PTSB430E</td> <td>265V 25A</td> </tr> <tr> <td>PTSB000E</td> <td>Non-electrical</td> </tr> </table>	PTSB215E	115V/15A	PTSB320E	230/208V 15/20A	PTSB330E	230/208V 30A	PTSB420E	265V 15/20A	PTSB430E	265V 25A	PTSB000E	Non-electrical	
PTSB215E	115V/15A													
PTSB320E	230/208V 15/20A													
PTSB330E	230/208V 30A													
PTSB420E	265V 15/20A													
PTSB430E	265V 25A													
PTSB000E	Non-electrical													
<p>LEVELING LEGS Gives wall sleeve front support and helps to level the unit for installation.</p>	<table border="1"> <tr> <td>LL2B</td> <td>Leveling legs for WS9** sleeves</td> </tr> </table>	LL2B	Leveling legs for WS9** sleeves											
LL2B	Leveling legs for WS9** sleeves													
<p>HARD-WIRE KITS Used to permanently wire to the chassis when a standard sub-base and power cord are not utilized. FACTORY INSTALLED Feature Code - W</p>	<table border="1"> <tr> <td>PTPWHWK4</td> <td>Armored Cable – all voltages</td> </tr> <tr> <td>PTQC3A</td> <td>Quick Connect – 230/208V</td> </tr> <tr> <td>PTQC4A</td> <td>Quick Connect – 265 & 115 V</td> </tr> </table>	PTPWHWK4	Armored Cable – all voltages	PTQC3A	Quick Connect – 230/208V	PTQC4A	Quick Connect – 265 & 115 V							
PTPWHWK4	Armored Cable – all voltages													
PTQC3A	Quick Connect – 230/208V													
PTQC4A	Quick Connect – 265 & 115 V													
<p>POWER DISCONNECT SWITCH The PSHW**A power disconnect switch can be used for 265-volt or 230/208-volt physical disconnect, where required by local codes. The switch is rated at 30-amp capacity. The switch is for use with and Amana® brand standard sub-bases or PTPWHWK4 Hard Wire Kit.</p>	<table border="1"> <tr> <td>PSHW03A</td> <td>230/208V</td> </tr> <tr> <td>PSHW04A</td> <td>265V</td> </tr> </table>	PSHW03A	230/208V	PSHW04A	265V									
PSHW03A	230/208V													
PSHW04A	265V													
<p>FUSE HOLDER KIT Cartridge-style fuses can be installed in the fuse holder for use in the sub-base or chassis. Available in 15, 20 and 30 amp (included on 265-volt unit).</p>	<table border="1"> <tr> <td>FHK315E</td> <td>230/208V 15A</td> </tr> <tr> <td>FHK315E</td> <td>230/208V 15A (R-410A)</td> </tr> <tr> <td>FHK320C</td> <td>230/208V 20A</td> </tr> <tr> <td>FHK320E</td> <td>230/208V 20A (R-410A)</td> </tr> <tr> <td>FHK330C</td> <td>230/208V 30A</td> </tr> <tr> <td>FHK330E</td> <td>230/208V 30A (R-410A)</td> </tr> </table>	FHK315E	230/208V 15A	FHK315E	230/208V 15A (R-410A)	FHK320C	230/208V 20A	FHK320E	230/208V 20A (R-410A)	FHK330C	230/208V 30A	FHK330E	230/208V 30A (R-410A)	
FHK315E	230/208V 15A													
FHK315E	230/208V 15A (R-410A)													
FHK320C	230/208V 20A													
FHK320E	230/208V 20A (R-410A)													
FHK330C	230/208V 30A													
FHK330E	230/208V 30A (R-410A)													
<p>CIRCUIT BREAKER KIT (230/208V ONLY) The circuit breaker kit, available in 15, 20 or 30 amp, can be used with Amana brand sub-bases. It gives overcurrent protection, and its location allows you to turn the unit on or off without tools.</p>	<table border="1"> <tr> <td>CBK15C</td> <td>15 amp Circuit Breaker Kit</td> </tr> <tr> <td>CBK20C</td> <td>20 amp Circuit Breaker Kit</td> </tr> <tr> <td>CBK30C</td> <td>30 amp Circuit Breaker Kit</td> </tr> </table>	CBK15C	15 amp Circuit Breaker Kit	CBK20C	20 amp Circuit Breaker Kit	CBK30C	30 amp Circuit Breaker Kit							
CBK15C	15 amp Circuit Breaker Kit													
CBK20C	20 amp Circuit Breaker Kit													
CBK30C	30 amp Circuit Breaker Kit													

Accessories (cont.)

DUCT EXTENSION KIT

Extends air distribution to an adjoining room. Consists of a main duct for the room of origin and an extension duct to reach the adjoining room and terminal duct. PTDK01A allows for the "B" series unit to work with the "A" series duct kits.

MDK02B	Main Duct – R-22
MDK01E	Main Duct – R-410A
EDK02B	42" Extension Duct

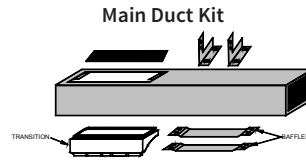

Extension Duct Kit



TDK02B	Terminal Duct
PTDK01A	Transition Duct Only – R-22
PTDK01E	Transition Duct Only – R-410A

Terminal Duct Kit

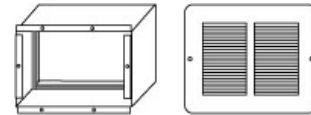

POWER VENT KIT

Installation of Power Vent increases CFM up to approximately 95. Vent door will automatically close when unit fan is off.

FACTORY INSTALLED Feature Code - V

R-410A models must have these kits installed at the factory.

PVK3A	230/208V – R-22
PVK4A	265V – R-22

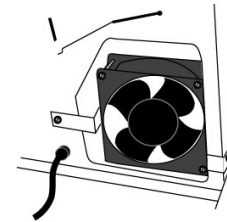

CONDENSER BAFFLE KIT

For use on non-baffled grilles. These deflectors direct the air in toward the center and away from the inlet to prevent recirculation of the hot condenser air.

DGK1B	Condenser Baffle Kit
-------	----------------------

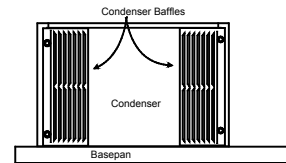

SUB-BASE EXTENSION COVER KIT

Converts older 30-amp sub-bases to allow for installation of the larger 30-amp LCDI power cord and plugs.

SBEC10A	10 Pack
---------	---------

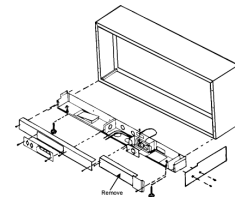

CONDENSATE REMOVAL PUMP

Can be field-installed. Assists in removing condensate developed by heat pump operation and transfers it to indoor coil to dissipate into room while adding humidity to the room.

FACTORY INSTALLED Feature Code - P

CDP302	230/208V – R-22
CDP402	265V – R-22
CDP303E	230/208V – R-410A



SECURITY KEY LOCKS







In conjunction with the tamper-resistant front, the installation of Amana® brand security key locks prevents tampering of the controls used to set temperature, heating and cooling functions. UL approved for institutional use only.

KL03B	Security Key Lock (R-22)
KL03E	Security Key Lock (R-410A)

Accessories (cont.)

Thermostats

The following thermostats offer remote control. Any thermostat other than those listed must be submitted to Goodman Company, L.P., for approval prior to use.

MODEL #	HEAT STAGES	COOL STAGES	FAN SPEED	# OF WIRES REQUIRED	TEMP LIMITING	BACKLIT	DISPLAY	TYPE	SHAPE & ORIENTATION	CONNECTION
PWHT-A100C 	1	1	2	6	Yes	Yes	Digital	Manual	Square/Vertical	Wired
PHWT-A150H 	2	2	2	7	Yes	Yes	Digital	Manual	Square/Vertical	Wired
PHWT-A200 	2	2	2	7	Yes	Yes	Digital	Programmable/Auto-Change	Square/Vertical	Wired
DS01G ¹ 	2	2	2	0	Yes	Yes	Digital	Manual/Energy Management	Square/Vertical	Wireless
DSA01NM 	2	2	2	0	Yes	Yes	Digital	Manual	Rectangular	Wireless
DS02G-H 	2	2	2	7	Yes	Yes	Digital	Manual/Hilton Connected Room Compatible	Square/Vertical	Wired

¹Battery powered, but has optional hard wire capability. Requires DT01G Antennae for operation

HYDRONIC HEAT KIT

Add-on kits fit all units allowing the addition of hydronic water or hydronic steam heat to cooling and heating units. The kits feature left- or right-hand piping. Unit retains complete service access with a kit installed. Unit must be connected to and operated by a wall thermostat.

HWK03B	Hydronic Water Kit – R-22
HVK03B	Hydronic Steam Kit – R-22
HWK03E	Hydronic Water Kit – R-410A
HVK03E	Hydronic Steam Kit – R-410A

Hydronic Heat Kit: Side View

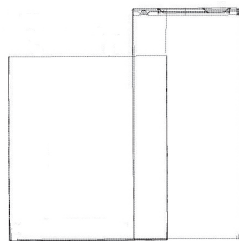



Hydronic Heat Kit: Top View

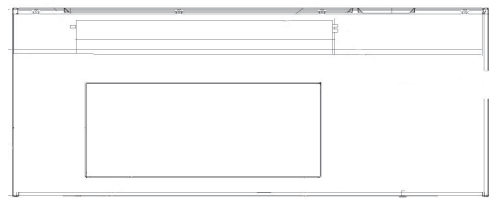

Hydronic Heat Kit: Right View

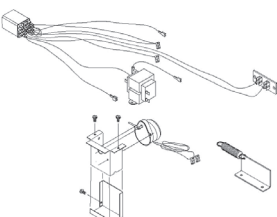

Accessories (cont.)

<p>POWER DOOR KIT Vent door will automatically open when unit fan is on. Factory Installed Feature Code - D</p>	<table border="1"> <tr> <td>PDK3A</td> <td>230/208V – R-22</td> </tr> <tr> <td>PDK4A</td> <td>265V – R-22</td> </tr> <tr> <td>PDK3E</td> <td>230/208V – R-410A</td> </tr> <tr> <td>PDK4E</td> <td>265V – R-410A</td> </tr> </table>	PDK3A	230/208V – R-22	PDK4A	265V – R-22	PDK3E	230/208V – R-410A	PDK4E	265V – R-410A									
PDK3A	230/208V – R-22																	
PDK4A	265V – R-22																	
PDK3E	230/208V – R-410A																	
PDK4E	265V – R-410A																	
<p>HYDRONIC VALVES Water and steam valves are available for use with the HWK03 (water) and HVK03 (steam) heat kits.</p>	<table border="1"> <tr> <td>VW2WNCA*</td> <td>2-way/24V/NC/End Switch</td> </tr> <tr> <td>VW2WNOA*</td> <td>2-way/24V/NO/End Switch</td> </tr> <tr> <td>VW3WNC2B*</td> <td>3-way/24V/NC/NO/End Switch</td> </tr> </table> <p>* Poptop Actuator</p>	VW2WNCA*	2-way/24V/NC/End Switch	VW2WNOA*	2-way/24V/NO/End Switch	VW3WNC2B*	3-way/24V/NC/NO/End Switch											
VW2WNCA*	2-way/24V/NC/End Switch																	
VW2WNOA*	2-way/24V/NO/End Switch																	
VW3WNC2B*	3-way/24V/NC/NO/End Switch																	
<p>WIRELESS RF (RADIO FREQUENCY) CONTROLS All PTACs come factory-ready to be controlled via wireless RF devices. 2.4 Ghz 802.15.4 protocol assures robust communications and response.</p>	<table border="1"> <tr> <td>DS01G</td> <td>Thermostat: 2-way² Communications</td> </tr> <tr> <td>DD01E</td> <td>Occupancy Sensor: EMS Activation²</td> </tr> <tr> <td>DT01G</td> <td>Antenna / Router Factory Installed Feature Code - R</td> </tr> <tr> <td>GT01G</td> <td>Generic Radio Antenna / Router³</td> </tr> <tr> <td>DD01F</td> <td>Door Switch: EMS Activation²</td> </tr> <tr> <td>DL01G</td> <td>Web-enabled Platform Server Link BAC-NET capable</td> </tr> <tr> <td>DR01G</td> <td>Mesh Repeater¹</td> </tr> <tr> <td>DL01G-SERIAL</td> <td>Serial Repeater¹</td> </tr> </table> <p>¹ Consult Amana Sales representative prior to purchase ² Requires DT01G for use ³ Requires DS01G for use</p>	DS01G	Thermostat: 2-way ² Communications	DD01E	Occupancy Sensor: EMS Activation ²	DT01G	Antenna / Router Factory Installed Feature Code - R	GT01G	Generic Radio Antenna / Router ³	DD01F	Door Switch: EMS Activation ²	DL01G	Web-enabled Platform Server Link BAC-NET capable	DR01G	Mesh Repeater ¹	DL01G-SERIAL	Serial Repeater ¹	
DS01G	Thermostat: 2-way ² Communications																	
DD01E	Occupancy Sensor: EMS Activation ²																	
DT01G	Antenna / Router Factory Installed Feature Code - R																	
GT01G	Generic Radio Antenna / Router ³																	
DD01F	Door Switch: EMS Activation ²																	
DL01G	Web-enabled Platform Server Link BAC-NET capable																	
DR01G	Mesh Repeater ¹																	
DL01G-SERIAL	Serial Repeater ¹																	
<p>WALL SLEEVE EXTENSION ADAPTER KITS Room-side extension kits to increase the depth of the existing sleeve to allow for an industry-standard PTAC to be installed.</p>	<table border="1"> <tr> <td>SECM1001A</td> <td>1.5" Extension for 12½" Climate Master Sleeve (10 Pack)</td> </tr> <tr> <td>SEZA0501A</td> <td>2.5" Extension for 11½" Zone Air Sleeve (5 pack)</td> </tr> </table>	SECM1001A	1.5" Extension for 12½" Climate Master Sleeve (10 Pack)	SEZA0501A	2.5" Extension for 11½" Zone Air Sleeve (5 pack)													
SECM1001A	1.5" Extension for 12½" Climate Master Sleeve (10 Pack)																	
SEZA0501A	2.5" Extension for 11½" Zone Air Sleeve (5 pack)																	
<p>CURTAIN BAFFLE KIT The color matched polymer curtain baffles help to prevent curtains from falling into the discharge air stream and causing recirculation, reducing efficiencies and shortening compressor life.</p>	<table border="1"> <tr> <td>PTCB10B</td> <td>10 Pack for R-22 units</td> </tr> <tr> <td>PTCB10E</td> <td>10 Pack for R-410A units</td> </tr> </table>	PTCB10B	10 Pack for R-22 units	PTCB10E	10 Pack for R-410A units													
PTCB10B	10 Pack for R-22 units																	
PTCB10E	10 Pack for R-410A units																	

Monthly Maintenance

Intake Air Filters

It is extremely important to clean the inlet air filters once a month (or more often if operated in dusty or dirty locations or conditions) to properly maintain the operational performance of the PTAC unit. The two intake air filters (constructed of durable polypropylene) can be easily inserted into the cabinet front using the cabinet filter guides. Before cleaning the intake filters, turn the unit off by setting the mode switch to the OFF position. Filters should be cleaned as required. The following procedure is used to remove the intake filters:

1. Facing the unit, pull up on the filter handles located at the front top of the unit.
2. Pull each filter upward and remove.
3. Clean filters with vacuum or with running water. Reverse this procedure to reinstall the filters.

Note: Accessory filter kits are available from your sales person. All filters are permanent and cleanable. Consult your I&O Manual for other monthly cleaning instructions.

SPARE FILTERS

Helps keep dirt and lint out of the air and off the coil, thus increasing the unit's efficiency. Amana® brand filters are easy to remove, wash and replace.

FK10A	10-PACK - A SERIES
FK10B	10-PACK - B, C & D SERIES
FK10E	10-PACK - E & G SERIES (THIS MODEL REQUIRES 2 FILTERS PER CHANGE.)

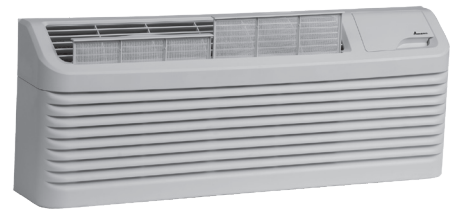

Unit with Accessory Wall Sleeve and Sub-base Accessory

TOP VIEW

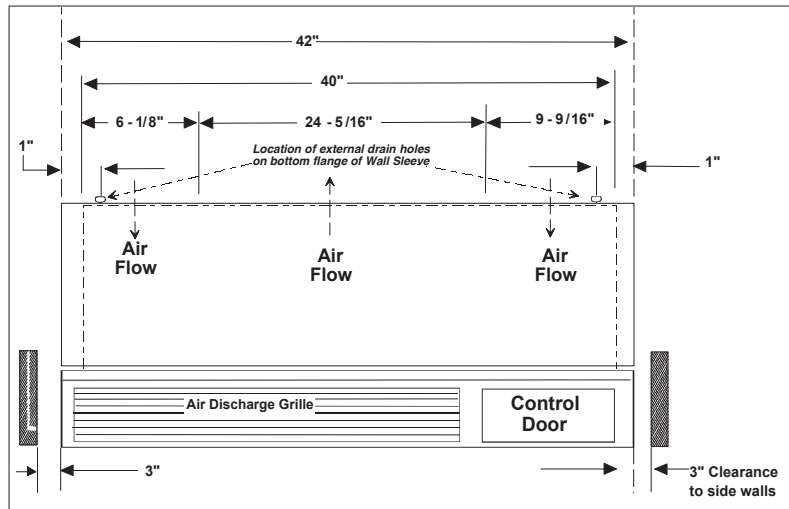

RIGHT VIEW

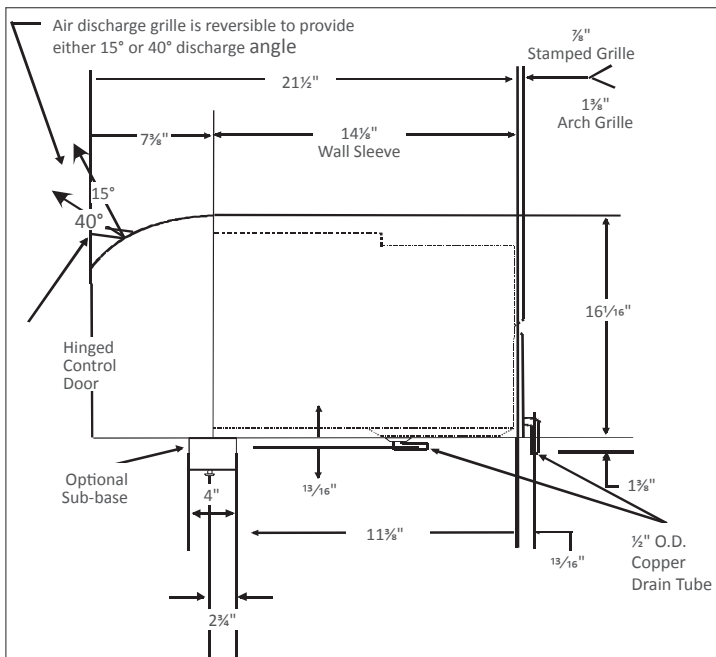

FRONT VIEW
 58" LCDI CORD SET — 230V/208V UNIT*

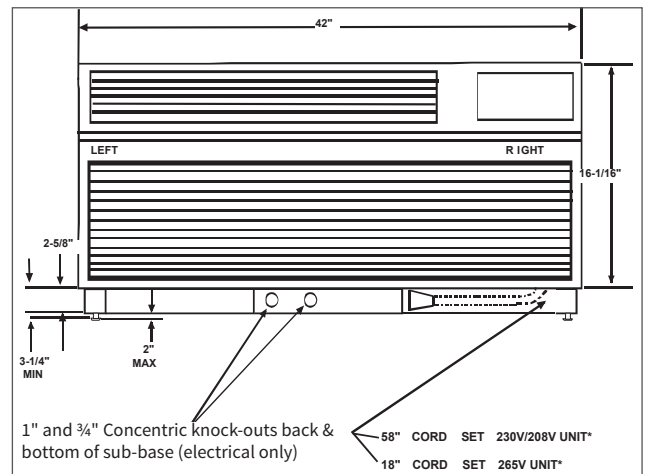

Framing for Accessory Wall Sleeve (WS9XX)

FASTENING WALL SLEEVE

When installed in an opening, the Wall Sleeve must be horizontally level (side-to-side) and pitched $\frac{1}{4}$ bubble to the outside.

(NOTE: If using an internal drain kit, the sleeve must be level from front to back.)

(NOTE: To ensure unit's maximum efficiency, **DO NOT** over- or under-pitch.)

INSTALLATION NOTES

1. If **Sub-base** (PTSB***E) is installed, allow minimum $3\frac{1}{4}$ " height clearance and maximum 5" height clearance between wall sleeve and floor; allow minimum $2\frac{3}{4}$ " protrusion from a finished wall. See Note 4 if using hydronic units.
2. **Drain Kit** (DK900D) shipped separately. Can be mounted either right side, left side or bottom of sleeve. If mounted to bottom of sleeve, allow 2" height clearance from floor to bottom of sleeve.
3. For UL approval, 265V units must use Amana® brand **Sub-base** (PTSB***E) or Amana® brand **Hard Wire Kit** (PSHW04A). Overcurrent protection on 265V units must be by cartridge-style time delay fuses, **which are included and factory-installed on the Amana® brand 265V chassis.**
4. If **Hydronic Kit** (HWK03 or HVK03) is installed, **Wall Sleeve** must extend exactly 3" into the room from the finished interior wall. If using the Amana® brand **Sub-base** (PTSB***E), only the minimum $3\frac{1}{4}$ " height clearance between wall sleeve and floor is permissible. Unit must also be operated with a remote-mounted thermostat.
5. If **Duct Kit** (MDK***E) is installed, allow a minimum of $2\frac{3}{8}$ " into the room from the finished interior wall.

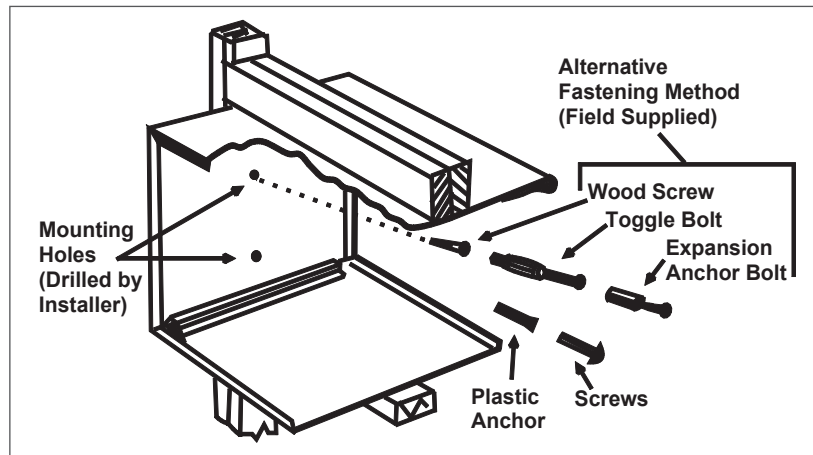

Wall Sleeve must extend a minimum of $\frac{1}{4}$ " beyond outside wall to allow for proper caulking.

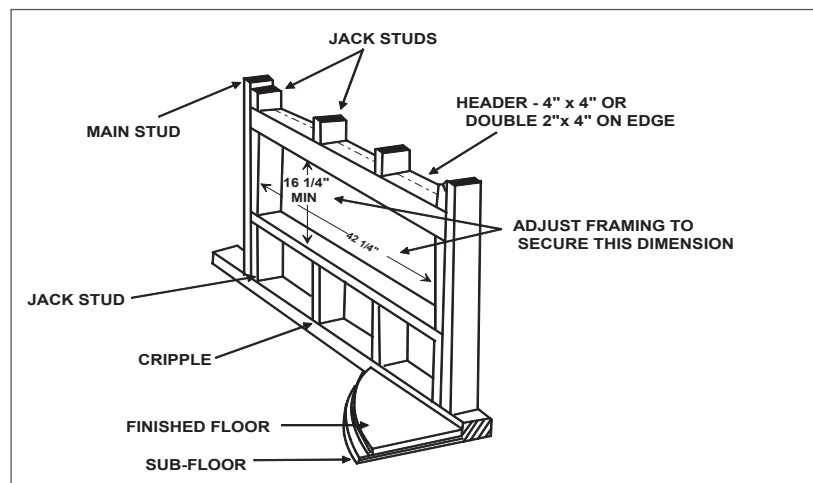

Wall sleeve opening height should be squared with wall sleeve opening width.

H = $16\frac{1}{4}$ "

W = $42\frac{1}{4}$ "

A legacy of comfort
 The impeccable reputation of
 an American original

Amana heating and cooling systems are a part of the enduring legacy of one of America's most recognized and respected brands. Originating eight decades ago in Amana, Iowa, the brand is synonymous with long-lasting, premium-quality products — from home appliances to heating and air conditioning equipment. Chances are, you and generations before you have enjoyed the dependable performance and longevity the Amana brand continues to deliver.



Proudly Assembled in Texas and Tennessee



Intertek

COMPANY WITH
 ENVIRONMENTAL SYSTEM
 CERTIFIED BY DNV GL
 = ISO 14001 =

COMPANY WITH
 QUALITY SYSTEM
 CERTIFIED BY DNV GL
 = ISO 9001 =



Call your Amana brand PTAC sales representative at **800-647-2982** for complete details.

Before purchasing this appliance, read important information about its estimated annual energy consumption, yearly operating cost, or energy efficiency rating that is available from your retailer.

www.amana-ptac.com