

# Model Specific Operation Manual

---

## Atom series

9 HPS | 12 | 15 | 20

**KVANT**<sup>®</sup>

[www.kvantlasers.sk](http://www.kvantlasers.sk)



# Table of Contents

<b>Introduction</b> .....	<b>1</b>
<b>General Information</b> .....	<b>2</b>
What is a laser and how does it work? .....	4
Laser Safety First!.....	6
Installation of the System .....	7
Control System .....	8
Scanning System .....	9
Connection Diagram .....	11
Multiple System Interlock .....	12
Switching ON sequence and User Interlock.....	13
Maintenance .....	16
<b>Item Checklist</b> .....	<b>17</b>
<b>Optional Accessories</b> .....	<b>19</b>
<b>System Overview</b> .....	<b>20</b>
Front View.....	21
Rear View .....	22
<b>Beam Alignment</b> .....	<b>25</b>
Beam Alignment [Atom 9 HPS, Atom 12, Atom 15].....	27
Beam Alignment [Atom 20].....	30
<b>Technical Specifications</b> .....	<b>33</b>
Technical Specification [Atom 9 HPS] .....	34
Technical Specification [Atom 12] .....	35
Technical Specification [Atom 15] .....	36
Technical Specification [Atom 20] .....	37

# Introduction

---

**Thank you for purchasing this KVANT product.**

To ensure proper operation, please read this manual carefully before using the product.  
After reading it, keep it in a safe place for future reference.

# General Information

✿ The following chapters explain important information about lasers in general, basic **laser safety** and some tips about how to use this device correctly. Please spend some time reading these information as some of them are critical for safe and efficient operation of this laser display system.



LASER RADIATION  
 AVOID EYE OR SKIN EXPOSURE TO  
 DIRECT OR SCATTERED RADIATION  
 CLASS 4 LASER PRODUCT  
 IEC 60825-1

**DANGER**

LASER RADIATION  
 AVOID EYE OR SKIN EXPOSURE  
 TO DIRECT OR SCATTERED RADIATION  
 CLASS IV LASER PRODUCT

**Diode Laser**

\_\_\_ W MAX OUTPUT AT \_\_\_ nm  
 \_\_\_ W MAX OUTPUT AT \_\_\_ nm  
 \_\_\_ W MAX OUTPUT AT \_\_\_ nm  
 TOTAL MAX OUTPUT  
 W AT \_\_\_ nm

**IEC 60825 - 1:2007**

	<b>CAUTION</b> RISK OF ELECTRIC SHOCK DO NOT OPEN	
--	--	--

CAUTION: TO REDUCE THE RISK OF ELECTRIC SHOCK, DO NOT REMOVE COVER OR BACK PANEL. SERVICEABLE PARTS INSIDE. REFER SERVICING TO QUALIFIED SERVICE PERSONNEL.

**CAUTION**

LASER LIGHT IS BRIGHT AND BLINDING DO NOT SHINE AT AIRCRAFT OR VEHICLES AT ANY DISTANCE

**CAUTION**

CLASS 4 VISIBLE LASER RADIATION WHEN OPEN AND INTERLOCKS DEFEATED

AVOID EYE OR SKIN EXPOSURE TO DIRECT OR SCATTERED RADIATION

## Caution

! This laser entertainment system is rated as a **Class IV laser product** and manufactured in accordance to **EN 60825-1:2014**. Avoid eye or skin exposure to direct or scattered radiation. Wear protective goggles of suitable optical density if necessary.

! If the laser is operated in a situation where health or property injury may occur the operation must be stopped immediately.

! The manufacturer and its distributors cannot be held responsible for any damages caused by improper use or misuse of this KVANT laser system. The owner/user is fully responsible for using this product in accordance to laser safety regulations of the country or state where the system is being used.

Please note that some other optical devices such as cameras, camcorders, video projector etc. can be damaged if exposed to excessive laser radiation.

## Handling precautions

This laser system is a precision device that contains some sensitive opto-electronics components. DO NOT drop it or subject it to physical shock.

This laser system is not waterproof or dust-proof. Make sure to use an appropriate cover or enclosure if it is used in the rain, snow or similar severe environment conditions.

Do not leave the laser system in excessive heat such as in a car whilst in direct sunlight. High temperatures could cause some serious damage to the system.

The laser system contains precision electronic circuitry. Never attempt to disassemble the laser yourself.

If the laser is suddenly brought in from the cold into a warm room, condensation may form on the laser and internal parts. If condensation forms on the laser body, do not use the laser as this may damage the laser system. If there is condensation, wait until it has evaporated before using it.

# What is a laser and how does it work?

---

## What is a LASER?

The laser is a bunch of energy waves (streams of photons called radiation) with the same amplitude and phase that are flowing in the same direction; meaning they are coherent – they stick together and form a laser beam.

The width of a single wave is measured in nano-meters and defines the colour and visibility of the laser beam. The visible spectrum of the human eye is roughly between 400nm and 700nm, going from violet to a dark red colour. A human eye is most sensitive to a green light of around 555nm, meaning that a 1W of green laser will always appear more visible than 1W of any other colour laser. 1W of quality laser light is very powerful and although it doesn't sound like much it can burn eye retinas, skin and clothes or even start a fire!

## What makes the laser visible?

Mainly it is the particles of dust in the air that the laser beam hits on its path. That's why we "laserists" use haze or smoke machines to make lasers more visible. Too much of the haze or smoke will kill it, but the right amount will make all the difference between no show and a great show.

When outdoors, lasers mainly reflect off dust and mist in the air but due to unpredictable wind conditions we can never make sure the hazers or smoke machines will be effective enough. And that's why we use high power lasers for outdoor shows – to substitute for the lack of dust, haze and smoke.

## How far does it go?

Depending on the power output of the system and weather conditions, the laser can be visible for miles – that is why we need to be cautious about aircrafts when performing outdoor shows. And if you get a system that is powerful enough then yes, it can reach the Moon.

## Colours

Standard full colour analogue lasers use three primary colours: Red, Green and Blue. By mixing those together you can pretty much get any secondary colour:

Red + Blue = Magenta

Red + Green = Yellow

Green + Blue = Cyan

Red + Green + Blue = White

Of course the number and precision of the colours is determined by the modulation, stability and linearity of the system. If the system is not stable enough, it will produce different colours every time it is used, making it virtually impossible to match the colours of two systems at any one time. This is very often the

case with systems from far east manufacturers and with re-branded lasers that are being presented as European makes.

## **Scanning System**

A scanning system is essentially two tiny mirrors, each moving on X or Y axis. By working together they can “scan” the laser beam in all directions. Once a shape is scanned more than 20 times per second, it appears static to the human eye. So any shape drawn by a laser is actually produced by one single laser beam being moved by these mirrors very quickly. Every scanning system has a mechanical limit of how fast it can move its mirrors and therefore how many points it can display at any one second and that is usually represented in Points Per Second at a certain scanning angle, i.e. 8 degrees.

# Laser Safety First!

---

! Before proceeding any further, please read the following safety page very carefully. It could help you avoid dangerous and hazardous situations which could lead to serious injury or property damage.

! Any laser system classified as a **Class 4** laser must be used with caution. If you are not an experienced laser operator we would strongly recommend that you attend a laser display safety course as soon as possible, and ideally before this laser system is used in public areas. There are various places in Europe where you can attend quality training and even a one day course will give you a good amount of valuable information to safely start with.

Unless you are very competent with the use of lasers and about the laser safety, make sure you **at least** follow these basic laser safety rules:

1. Never look directly into a laser beam.
2. Never look directly into laser aperture if the laser system is switched on.
3. Be aware that lasers can burn the eye retina, skin or cause fires if not used correctly.
4. Never perform Audience Scanning – that's when laser beams and effects hit an audience directly. Always project with the laser above audience head level – at least 3m above floor level.
5. When performing outdoors, avoid pointing the laser at aircrafts, buses, trains, etc.
6. Never leave the laser system unattended when it's switched on.
7. Always check for reflective surfaces within the laser range – these can be very dangerous (i.e. mirror behind the bar in a club could bounce the beam into bar attendant's eye).
8. Never hesitate to use the Emergency STOP if you think there's a fault within the laser system or a potential danger to a person/object caused by the laser performance.



# Installation of the System

---



The manufacturer is not liable for damages or a injury caused by improper installation of the system.

The installation should be carried by a qualified installer who should follow the Laser Safety Regulations of respective country.

Please follow these rules during the installation:

1. Do not connect the device to power supply during the installation.
2. Mount the system only to mounting point that is strong, secure and away from places where non-authorized person could get an access to.
3. Always make sure the system is properly tighten down and that it cannot get loose and move as a result of sound vibrations, cable pull or similar.
4. Always use a safety rope.
5. Ensure that all the cables have enough leverage just in case they get caught.
6. Ensure that the system is placed at least 20cm away from walls or any other objects including drapes etc.
7. Ensure that the system is placed well away from any heat sources including spotlights, moving heads, radiators, etc. Make sure there is a sufficient air-flow around the laser system.
8. It is essential that the fan openings are never covered during the laser operation.
9. Always follow the Laser Safety Regulations of respective country where the laser is being used.

# Control System

---

The overall performance of any KVANT laser system is also dependent on the control system that you use for operating the laser as well as the correct device configuration in the laser control software. Please make sure all the laser settings in your control system are set correctly before you start using your Kvant laser display system.

# Scanning System

---

The product warranty does not cover the damages to the scanning system caused by improper use of the scanning system or by incorrect programming. Therefore it is essential to understand how the scanning works and where are the limits of it. In this manual we will explain only the basics of it but it is the responsibility of every user to educate themselves so they can avoid damage being caused to the scanning system and costly repairs.

A laser beam comes from a laser module and hits the two moving mirrors of the scanning system. These mirrors are mounted on the scanner shafts and are moved by the scanner rotors, one on X and one on Y axis.

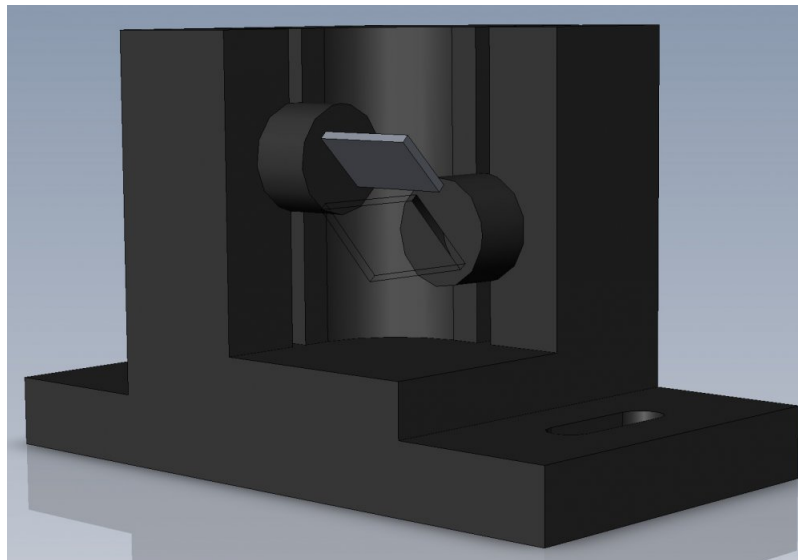

An effect such as tunnel (circle) is displayed by a repetitive mechanical movement of the scanners. For each scanning system and effect, there's a maximal scan rate that is defined by mechanical load, scanner mirror size and weight, complexity of displayed picture and size of the projection (an angle under the laser beam is being projected). A different scanning systems have different scan- rate limits. It is essential to operate the scanning system at scan-rates within its maximal limit at all times to prevent it from overload damage.

## How to establish correct Scan-rate and maximal number of points in an effect

Each effect (picture) contains a different number of graphical points which defines the actual shape of the effect. The more points an effect contains, the lower the maximum scan rate will be in relation to the scanning angle.

As an example we'll work with the star effect shown below and with the parameters of quality scanning system:

Let's say the star effect is made of 300 graphical points (including non-visible blanking points) and we know that the maximal scan-rate of our scanning system is 35kpps @ 8 degrees (= 35.000 points per second at 8 degrees projection angle). We also know that we display the star 35 times per second which is a default frame rate of the control software we are using.

So we need to display 300 points 35 times per second = 10.500 pps. This means that we could display 3 of these stars beside each other within one single laser effect and that it would be quite close to the scanner limit ( $3 \times 10.500 = 31.500$ pps). This however applies ONLY if the scanning angle is not more than 8 degrees on both axes! If we start to increase the size of the projection (scanning angle) it is necessary to either lower the number of points within the effect or drop down the scan-rate in the control software (FPS) to a safe level – which may result in flicker.

From the example above we can also determine how many points this scanning system is able to project if the scanning angle is not more than 8 degrees:

$35.000 \text{ points} / 35 \text{ Frames Per Second} = 1.000 \text{ pps}$ . This is the absolute maximum of how many points we should be using when programming an effect if the scanning angle is not more than 8 degrees.

In the following pictures you see the same star effect scanned at different scan rates at full scanning angle (60 degrees).

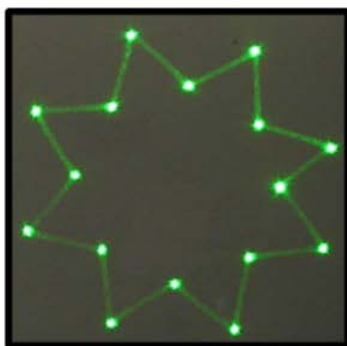

picture 1

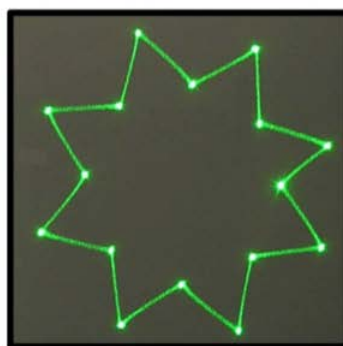

picture 2

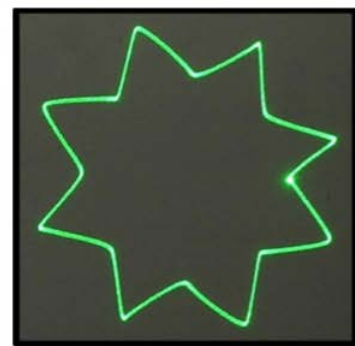

picture 3

**Picture 1:** the scan rate and/or number of points is too low. The corner points are more visible than the lines between them and the whole effect flickers. The scan-rate and/or number of points needs to be increased.

**Picture 2:** the scan-rate and/or number of points is about right. The whole effect has more or less the same intensity and does not flicker.

**Picture 3:** further increasing of the scan-rate and/or number of points results in the effect starting to distort, firstly around corners only. This indicates that you are exceeding the maximal scan rate of the scanning system! If you operate the scanning system at scan-rates higher than the maximum scan-rate of the scanning system the scanners will get damaged irreversibly due to overheated coils damaging rotor magnets.

# Connection Diagram

Please check that all the signal and power leads are correctly installed and that the safety keys are inserted in all necessary positions.

## Basic connection diagram

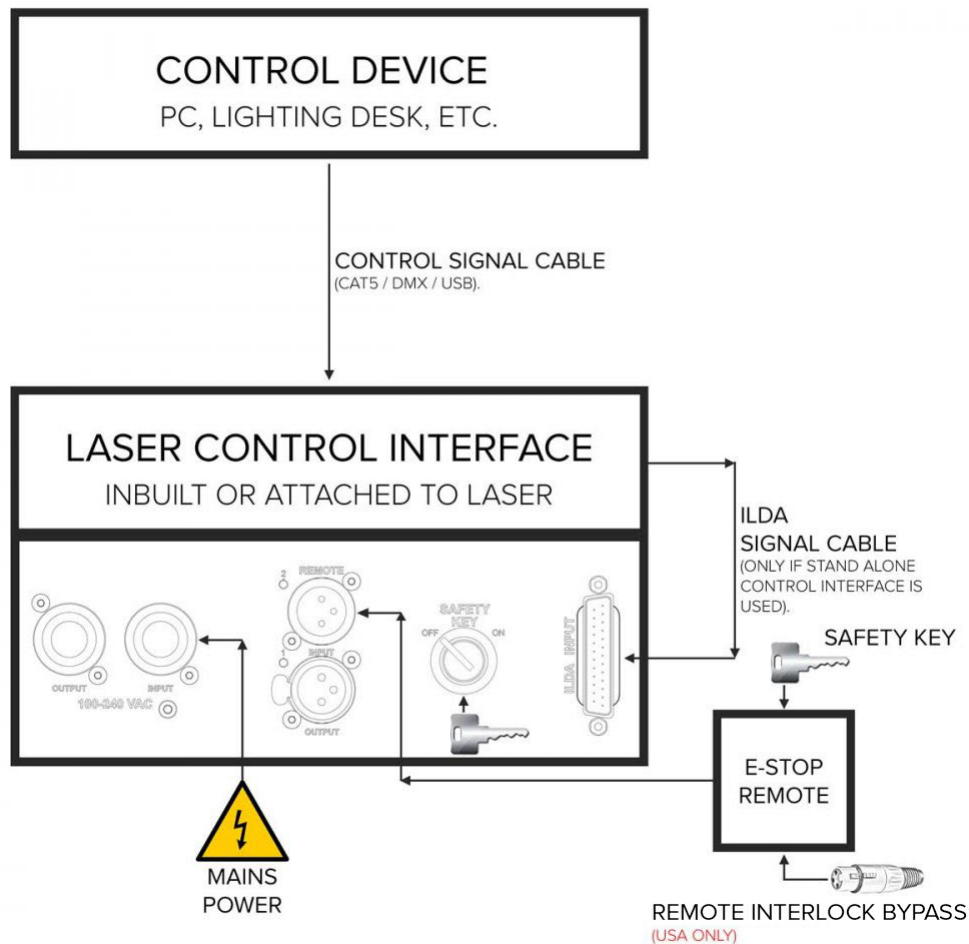

\* Both E-STOP Remote safety key and laser system safety key must be inserted and switched to ON position in order to disable the interlock.

! USA ONLY: Remote Interlock Bypass must be inserted in the E-STOP Remote as well in order to disable the interlock.

# Multiple System Interlock

Multiple laser projectors may be daisy chained and controlled by a single E-STOP Remote. Any event which enables the Interlock on any laser projector in the daisy chain will trigger the safety Interlock for all the systems. After the event has been corrected the START button on the E-STOP Remote must be pressed by the operator to disable the Interlock. After an Emission Delay period the laser projectors will be ready for use.

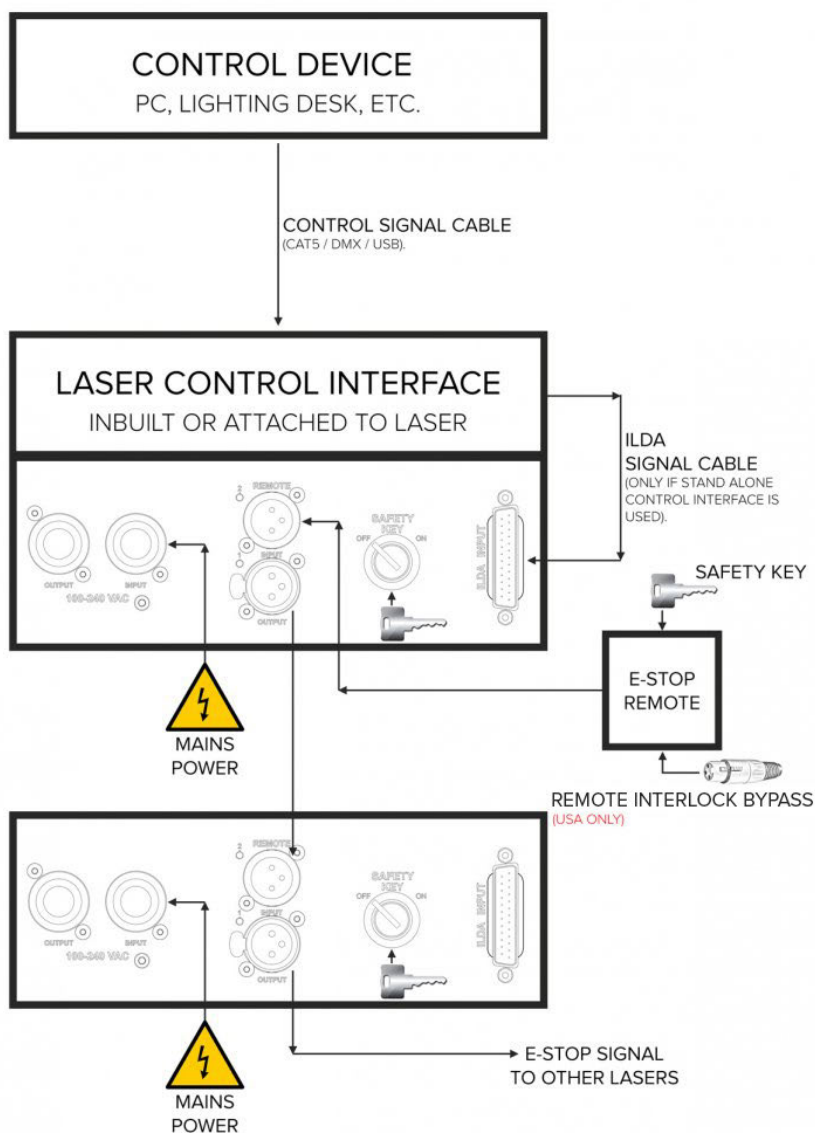

# Switching ON sequence and User Interlock

! Please make sure that all laser display safety requirements are fulfilled in accordance with laws of the country where this KVANT laser system is being used before switching the system ON.

1. Connect the system as showed on [Connection Diagram](#).
2. Turn both E-STOP Remote and laser system safety keys to ON position.
3. Release the E-STOP button by pulling it upwards.
4. Open the aperture window by loosening the bolt at the left of the aperture, adjust the masking plate to desired position and tighten the bolt to secure it.
5. Press the Main Power switch located at the back panel.
6. Press the START button on the E-STOP Remote.
7. After an Emission Delay Period the laser projector will be ready for use.

## Interlock Enabled, Laser Output Terminated

The Interlock is latched enabled and the laser projector's beam output will be terminated if any of the following events happen:

1. Power loss lasting greater than 2 seconds.
2. Mushroom emergency switch depressed.
3. #2 Key Switch on E-STOP Remote turned to OFF position.
4. #1 Key Switch on laser projector turned to OFF position.
5. Any other interruption to line No.1 of the cable leading to the E-STOP Remote. This includes any user interlocks connected in series in the line No. 1 of this cable. Refer to Connection Drawing below.

## Restarting Laser After Interlock or Power Failure Event

After the event has been corrected the START button on the E-STOP Remote must be pressed by the operator to disable the Interlock and after an Emission Delay period the laser projector will be ready for use.

### Interlock Connection Diagram

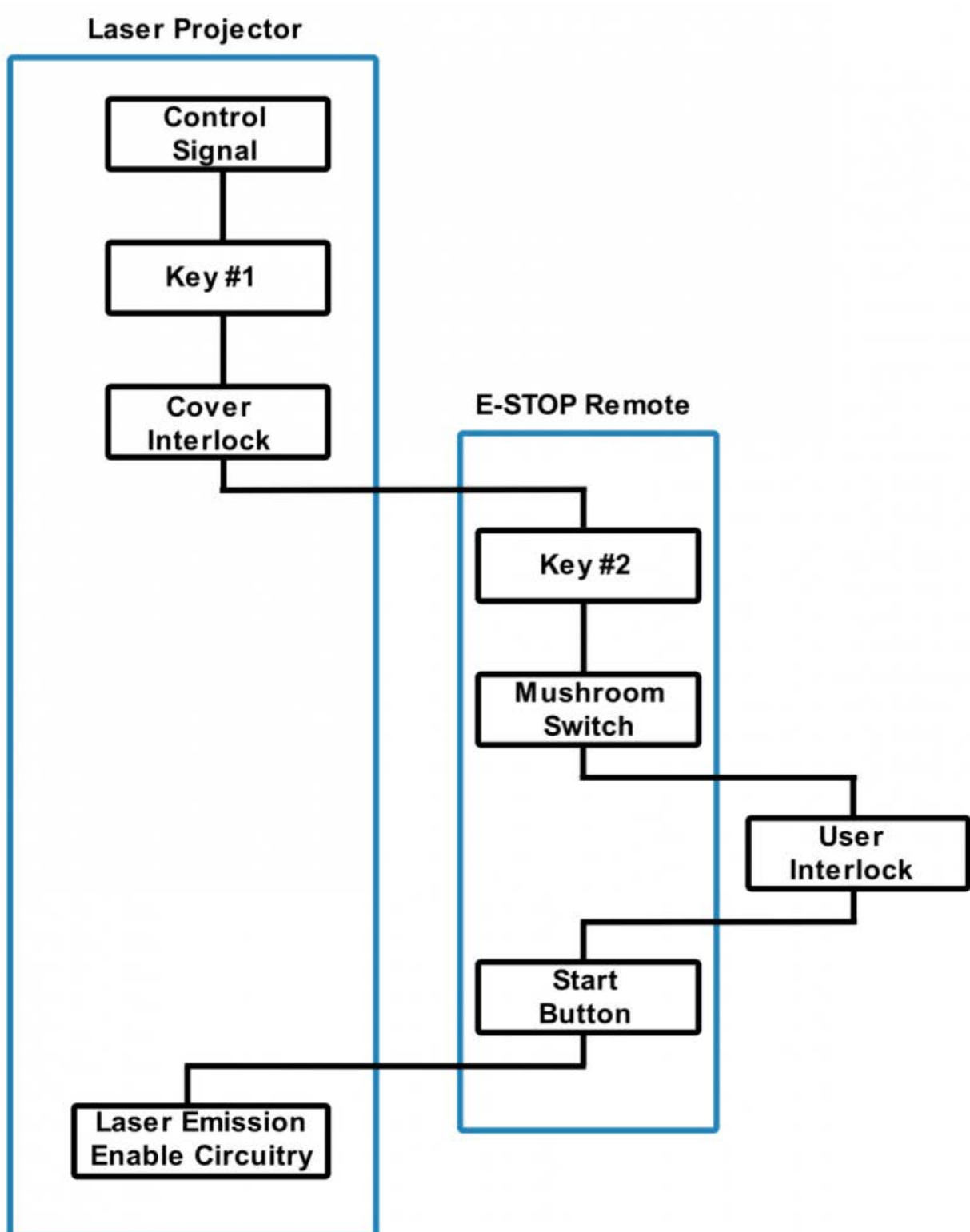



## E-STOP Connection Drawing including User Interlock option

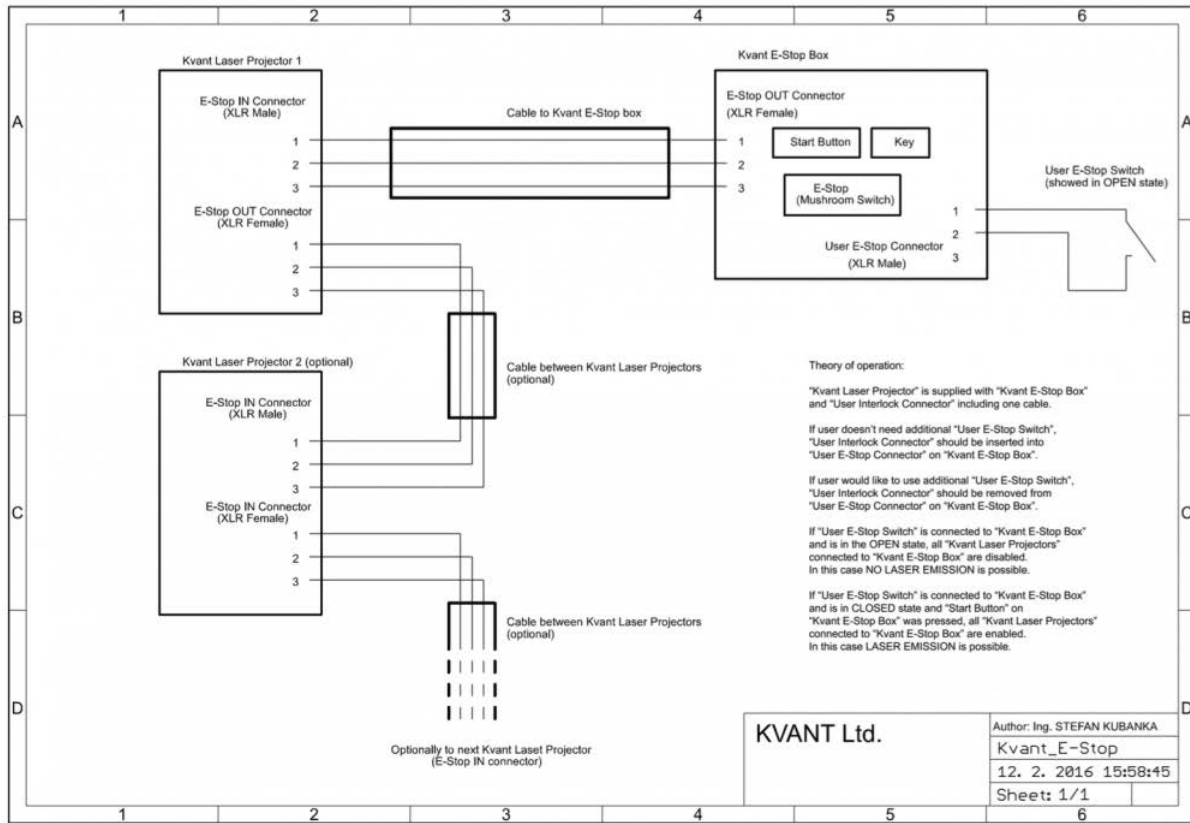

**!** The E-STOP Remote is an integral part of the laser projector. It is there for the safety of the public as well as the operator. Modifying or using anything other than the E-STOP Remote provided, in the manner it was intended, may invalidate your laser projector's variance.

# Maintenance

---

## Aperture Window

To clean the aperture output window use a soft cloth and medical grade isopropyl alcohol. If necessary, you can remove the aperture output window by loosening the 4 socket bolts and clean the inside of the window as well.

## Cooling Fans

Use compressed air for cleaning the front and back airflow slots of the laser system. There are cooling fans located behind the slots and they are vital for correct operation of the laser system. Please always ensure that they are spinning freely.







You should perform this service every 2 months if the laser is used regularly or even more often if it is used in dusty conditions.



## Internal Optics

The cleaning of the internal optical components should be performed by an authorised technician only. Incorrect techniques or wrong choice of chemicals used for cleaning could cause serious damage to the laser system. Due to the fact that the optical compartment is split and sealed from the rest of the laser system it shouldn't be necessary to perform this procedure more often than once a year.

# Item Checklist

Before starting, check that all the following items have been included with your laser system. If anything is missing, contact your supplier.



Item	Number of units	Description
	1	KVANT Atom Laser Display System
	1	Emergency STOP Remote
	1	3-pin XLR Emergency STOP Remote cable
	1	Remote Interlock Bypass (for USA only)
	1	AC Power cable
	2	Set of Safety Keys

	1	ILDA Signal Cable
	1	User manual USB drive
	1	Heavy duty flight case

# Optional Accessories

---

Here is a list of optional accessories that are compatible with Atom laser system.

Item	Description
	SafetyScan lens attachment bracket (lens is not included)
	DiscoScan lens attachment bracket (lens is not included)
	4-way masking plate

# System Overview

---

KVANT Atom is a full colour, semiconductor diode laser system designed for professional laser displays.

When operated correctly and in the right conditions the Atom laser system is able to deliver a strong performance in large indoor (Atom 9 HPS, Atom 12) and outdoor venues (Atom 12, Atom 20). The Atom can display virtually any colour within the basic RGB palette and its secondary mixed colours including white.

The system is air-cooled and designed so that there is no airflow going through the optical compartment of the system. This ensures that all important optical parts of the system stay clean for longer, keeping the maintenance time down to a minimum. This is a real advantage for all the venues where lots of smoke or haze is used on a daily basis.

This laser is IP rated to IP54, meaning that it is splash-proof. It is however important to understand that this system was designed for indoor use and therefore it must not be exposed to rain, snow or excessive amounts of dust.

# Front View

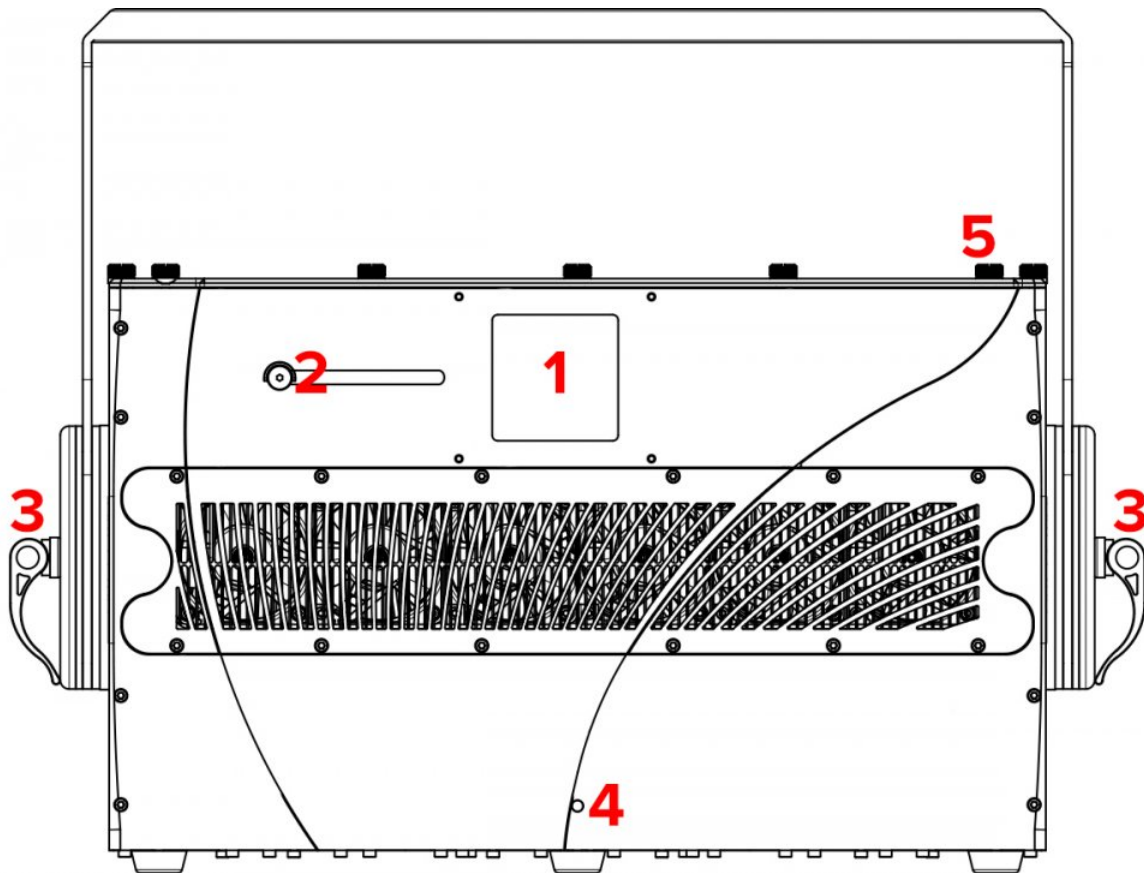

1. **Laser aperture window.** To clean the laser aperture window from inside or to swap the aperture window for a different type of aperture (i.e. DiscoScan lens attachment bracket), remove the four socket bolts that hold the laser aperture window in place and gently remove it.
2. **Aperture masking plate.** This metal masking plate can be moved left and right when locking bolt is loosened.
3. **Attachment bracket.** The attachment bracket spins 360 degrees around the laser body whilst it can be locked in desired position by four small locking handles on sides. Due to a sophisticated locking mechanism there's no need to use excessive force when locking the system in position.
4. **Laser emission indicator.** When this indicator is lit up the laser system is ready to emit the laser radiation as soon as it receives instructions from control software.
5. **Optical compartment cover bolts.** To access the optical compartment of the laser system undo 14 button hex bolts and carefully remove the cover.

## Rear View

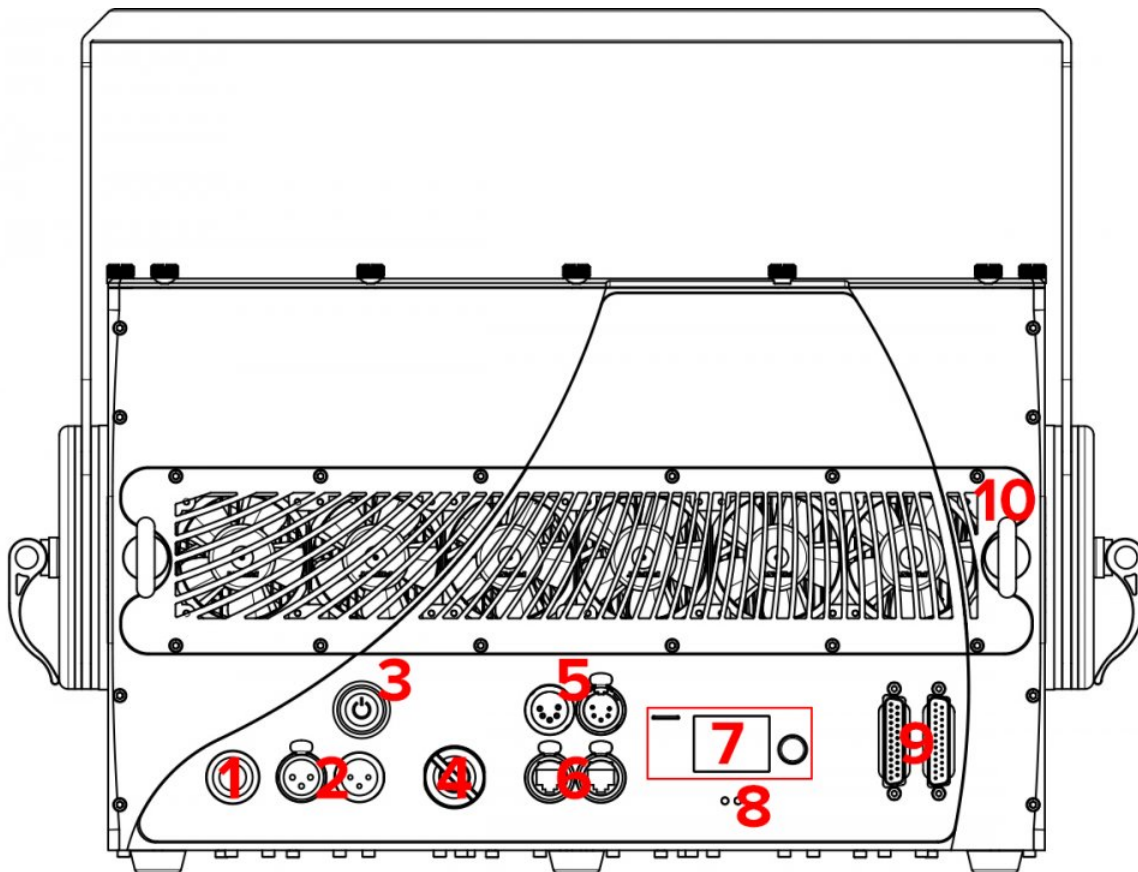

1. **Mains power.** Use supplied Neutrik Powercon power cable to connect the laser system to mains power supply.
2. **E-STOP Remote INPUT/OUTPUT.** In order to use the laser system, the Interlock must be closed circuit. This is done by connecting the Emergency STOP Remote to the XLR REMOTE INPUT socket on the projector using the supplied cable. The US version of the Emergency STOP must also have the Remote Interlock Bypass inserted into it.

! The E-STOP Remote is an integral part of the laser projector. It is there for the safety of the public as well as the operator. In most countries it is required by law to have a fully working Emergency STOP in place for every laser system used. Modifying or using anything other than the E-STOP Remote provided, in the manner it was intended, may invalidate your laser projector's variance.



The Remote Interlock Bypass may be replaced by the user's own interlock system using a switch or dry relay closure to connect pins 1 and 2. With pins 1 and 2 shorted, Laser Emission is possible, provided all other interlocks are closed circuit. With pins 1 and 2 open, NO Laser Emission is possible.

The Interlock status indicator START (2) goes off and status indicator READY (2) lights up when the Interlock is closed circuit and the Interlock key is in the ON position. All above must be done correctly to allow laser emission from the system.

The projector's REMOTE Output is used to daisy-chain the Remote signal when you want to use a single Emergency STOP Remote to control multiple systems.

After a power failure or interlock failure (open circuit) has occurred and been corrected you need to manually reset laser emission by pressing the START button on the E-STOP Remote. Laser emission will then be available after a 60 second delay.

3. **Mains power switch.**
4. **Safety key switch.** The Safety key must be inserted and turned to ON position in order to enable the system to operate.
5. **DMX Input/Through.** Use these ports to connect DMX control signal or to daisy chain the DMX signal between multiple laser display systems.
6. **Ethernet.** Use these ports to connect PC control signal or to daisy chain the control signal between multiple laser display systems.
7. **FB4 laser control interface.** The inbuilt control interface allows you to control the laser via Ethernet and DMX/ArtNet, but it also handles all the basic settings of the laser system (master size and positions, method of control, colour settings etc.). All of these settings can be accessed through the menu using the endless rotary knob and once saved, they are stored on included mini SD card.
8. **Colour Balance display mode switch.** When the Colour Balance display mode is active, all the colours displayed by laser will match those you see on the screen in your laser software (they can vary slightly, depending on your display and its colour settings).  
The on & off setting of Colour Balance mode is immediately stored in the internal memory of the laser projector, so next time you power it up, the Colour Balance mode is set to its latest state automatically.



The usual intent of laser manufactures is to produce a laser diode driver with as linear response behaviour as possible. So when the diode current increases, the optical power and light intensity grow linearly.

The problem is that human eye senses brightness of light logarithmically over a moderate range (Weber–Fechner law).

So when light intensity grows linearly, human eye and brain don't see it that way and our visual perception of colours changes.

In the world of laser display systems this generates problems when we work with mixed colours (i.e. yellow, magenta etc.). Normally the mixed colours coming out of laser systems do not entirely correspond with those we see on computer screens – because of the difference in visual perception.

In order to synchronise all the colours we see on our screen and those coming out of the laser device we do, so called, palette calibration procedure in the laser control software.

This can be of course rather lengthy process and even if it's done properly, the calibrated palette will always be tied to particular control system or profile that was used during the colour calibration and not to the laser projector itself.

So we came with the idea to hard-code the “calibrated palette” into every Spectrum laser system in our factory during the manufacture. No matter what control interface you use or what control signal is used (Ethernet, DMX, ILDA) , the calibrated palette is always there, ready for you to be switched on by Colour Balance button.

9. **ILDA INPUT/OUTPUT.** ILDA INPUT connector is used for the control signal input from an external control interface. ILDA OUTPUT connector is used to daisy chain the control signal between multiple laser systems.
10. **Safety eyelet.** Use this together with appropriate safety wire to secure the system against unexpected fall.

# Beam Alignment

---

It is possible that due to transportation, rigging, moving around or vibrations caused by various elements during a set up or laser performance some of the internal optical parts can move slightly resulting in colour misalignment.

The colour misalignment is when two or more colours (red, green and blue) physically do not overlay each other properly like on the picture below. This makes it impossible to get nicely mixed colours like yellow, cyan, magenta and white (including all their shades). If this occurs it is necessary to carry out the beam alignment procedure.

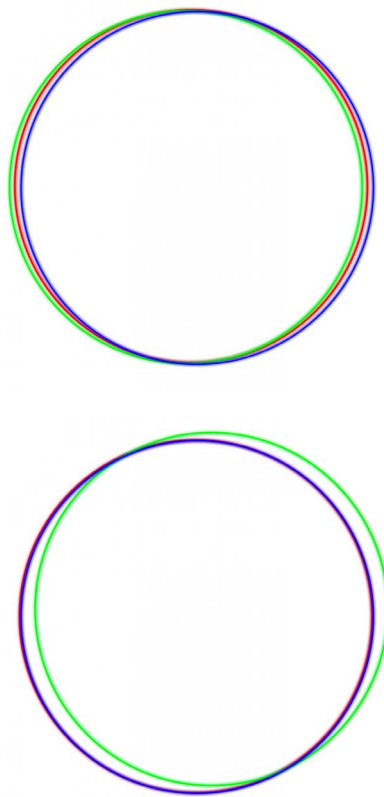

Be cautious when aligning the beams and wear sufficient laser safety protection to avoid accidental exposure to Class 4 laser radiation.

## Beam alignment principle.

There are three laser modules within this system where each module produces one of the basic RGB colours (red, green or blue).

The goal of the alignment procedure is to align all three beams (colours) so they overlay each other

nicely while they hit exact centre of the bottom scanning mirror.

An easiest way to do the alignment is to project a full size circle onto a wall (or any another suitable projection surface), change its colour as necessary and check the alignment of individual colours on both X and Y axes.



Remember that greater is the distance between the laser system and the projection surface during the alignment, more precise the alignment will be.

When doing the alignment on long distances it is always good to have someone with you who can point you in the right direction. Alternatively you can use binoculars.

# Beam Alignment [Atom 9 HPS, Atom 12 | 15]

1. Unscrew 14 silver bolts that hold down the top cover – they are spring loaded and will pop-up once loose.
2. Slowly remove the cover – **detach the GND wire** that is attached to the top cover from the inside of the system! To detach the wire gently pull it out from the connector.
3. Removal of the cover will show the two internal defeatable magnetic interlocks. You must flip over the right side of the magnetic interlock until it touches the other side. You will be able to read the warning label “Interlock Defeated”.



\* In the defeated position the label “INTERLOCK DEFEATED” becomes visible as shown in the image.

\* Placing the magnetic interlock in the defeated position raises the interlock higher than the edge of the housing which will not allow the cover to be installed.

4. Power up the system as normal.
5. Create a red beam effect (point) and check visually whether the red beam hits the exact centre of the bottom scanning mirror.

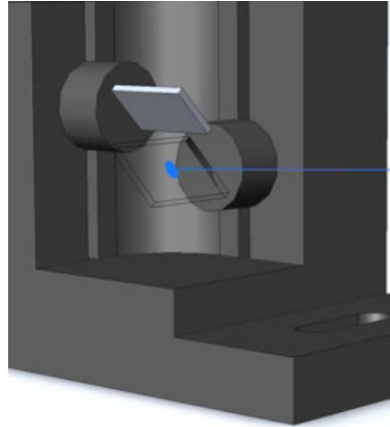

If not, use dichroic mounts DF5 to adjust the beam path accordingly (diagram below). To adjust the dichroic mount use the two adjustment knobs – each works for one axis.

6. Create a cyan beam effect (point) and check visually whether the green beam hits the exact centre of the blue beam at the dichroic filter DF2.

If not, use dichroic mounts DF1 to adjust the beam path accordingly. To adjust the dichroic mount use the two adjustment knobs – each works for one axis.

7. Create a full size cyan circle (static tunnel effect) and check whether the green circle overlays the blue circle in all points around the shape.

If not, use dichroic mount DF2 to adjust the beam path accordingly. To adjust the dichroic mount use the two adjustment knobs – each works for one axis.

8. Create a full size yellow circle (static tunnel effect) and check whether the green circle overlays the red circle in all points around the shape.

If not, use dichroic mount DF3 and/or DF4 to adjust the beam path accordingly. To adjust the dichroic mount use the two adjustment knobs – each works for one axis.

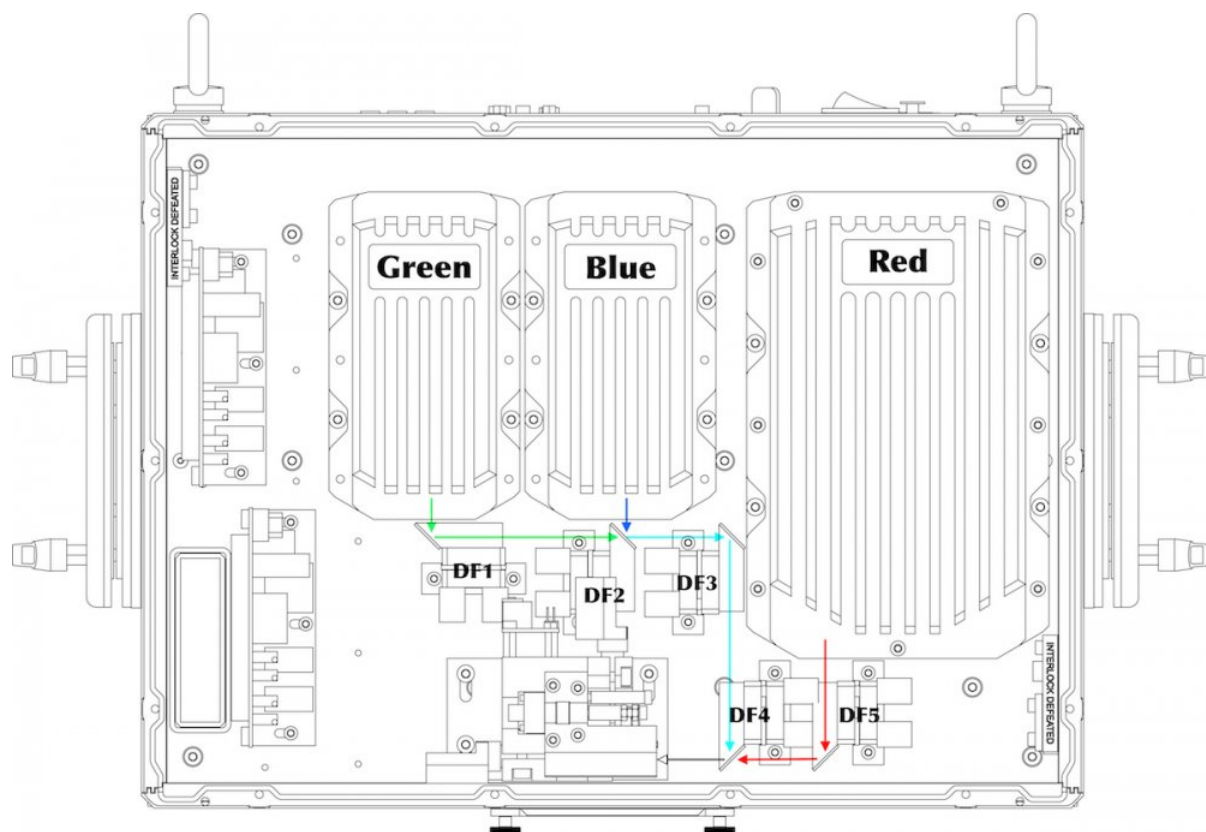

9. Finally create a full size white circle (static tunnel effect).

If the alignment procedure was done successfully you can see all the colours nicely overlaying each other, resulting in even, bright and sharp circle like the one on the picture below.

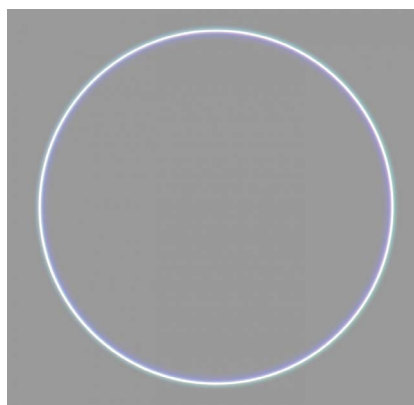

## Beam Alignment [Atom 20]

1. Unscrew 14 silver bolts that hold down the top cover – they are spring loaded and will pop-up once loose.
2. Slowly remove the cover – **detach the GND wire** that is attached to the top cover from the inside of the system! To detach the wire gently pull it out from the connector.
3. Removal of the cover will show the two internal defeatable magnetic interlocks. You must flip over the right side of the magnetic interlock until it touches the other side. You will be able to read the warning label “Interlock Defeated”.



\* In the defeated position the label “INTERLOCK DEFEATED” becomes visible as shown in the image.

\* Placing the magnetic interlock in the defeated position raises the interlock higher than the edge of the housing which will not allow the cover to be installed.

4. Power up the system as normal.
5. Create a red beam effect (point) and check visually whether the red beam hits the exact centre of the bottom scanning mirror.



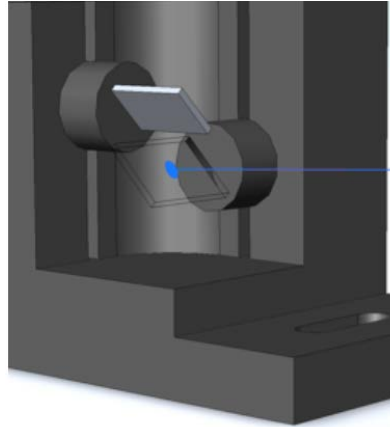

If not, use dichroic mounts DF4 to adjust the beam path accordingly (diagram below). To adjust the dichroic mount use the two adjustment knobs – each works for one axis.

6. Create a cyan beam effect (point) and check visually whether the green beam hits the exact centre of the blue beam at the dichroic filter DF2.

If not, use dichroic mounts DF1 to adjust the beam path accordingly. To adjust the dichroic mount use the two adjustment knobs – each works for one axis.

7. Create a full size cyan circle (static tunnel effect) and check whether the green circle overlays the blue circle in all points around the shape.

If not, use dichroic mount DF2 to adjust the beam path accordingly. To adjust the dichroic mount use the two adjustment knobs – each works for one axis.

8. Create a full size yellow circle (static tunnel effect) and check whether the green circle overlays the red circle in all points around the shape.

If not, use dichroic mount DF3 to adjust the beam path accordingly. To adjust the dichroic mount use the two adjustment knobs – each works for one axis.

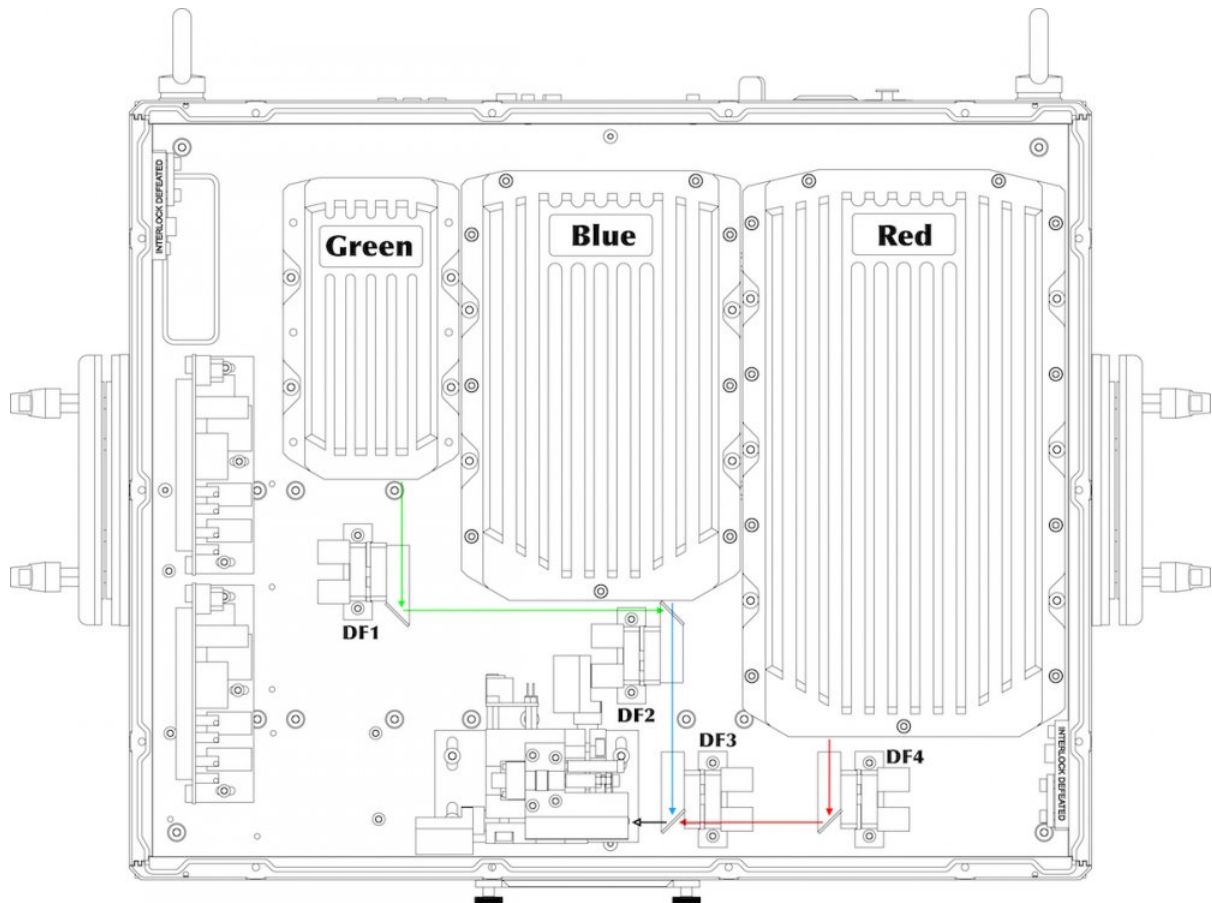

9. Finally create a full size white circle (static tunnel effect).

If the alignment procedure was done successfully you can see all the colours nicely overlaying each other, resulting in even, bright and sharp circle like the one on the picture below.

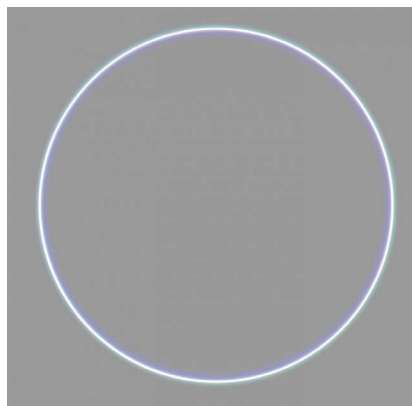

# Technical Specifications

---

All the technical specifications are subject to change without prior notice.

# Technical Specification [Atom 9 HPS]

## KVANT Atom 9 HPS – full colour, semiconductor diode laser system

Total Optical Power (installed): 8.55W

Total Optical Power (guaranteed): 8.5W\*

Maximum Output Power: 9.1W

*\*Due to Advanced Optical Correction technology used in our laser systems the optical power output of each laser colour within the system may slightly differ from the specification of respective laser module(s) installed. This does not affect the guaranteed total power output.*

Colour	Wavelength	Output
Red	637nm	2750mW
Green	520nm	1800mW
Blue	445nm	4000mW

NOHD (Nominal Ocular Hazard Distance): 650m

Beam diameter at laser aperture: 3 × 3mm

Beam divergence: <1mrad (full angle)

Modulation: 0-5V analog, up to 50kHz

Module cooling: TEC

Scanning System:

Saturn 1, 90kpps@7°, max. scanning angle 60° on both axes

Control signal: ILDA, Ethernet, ArtNet, SD Auto

Power requirements: 100-240V/50Hz (±5%)

Consumption: 390VA/100-240V

Operation temperature: 10-40°C

Ingress protection rating: IP54

Dimensions (WxDxH): 425 × 330 × 260mm

Weight: 30.5kg

Laser safety features: Keyed interlock, emission delay, magnetic interlock, scan-fail safety, V-RAD 506 mechanical shutter | reaction time <20ms, adjustable aperture masking plate.

This laser system fully complies with the latest EN 60825-1, FDA regulations and TUV Laser Safety.

# Technical Specification [Atom 12]

## KVANT Atom 12 – full colour, semiconductor diode laser system

Total Optical Power (installed): 12.6W

Total Optical Power (guaranteed): 12W\*

Maximum Output Power: 13.2W

*\*Due to Advanced Optical Correction technology used in our laser systems the optical power output of each laser colour within the system may slightly differ from the specification of respective laser module(s) installed. This does not affect the guaranteed total power output.*

Colour	Wavelength	Output
Red	637nm	3000mW
Green	520nm	3600mW
Blue	445nm	6000mW

NOHD (Nominal Ocular Hazard Distance): 771m

Beam diameter at laser aperture: 5 × 5mm

Beam divergence: <1mrad (full angle)

Modulation: 0-5V analog, up to 50kHz

Module cooling: TEC

Scanning System:

Cambridge Technology CT6215 | 30kpps@8°, max. scanning angle 60° on both axes

Control signal: ILDA, Ethernet, ArtNet, SD Auto

Power requirements: 100-240V/50Hz (±5%)

Consumption: 390VA/100-240V

Operation temperature: 10-40°C

Ingress protection rating: IP54

Dimensions (WxDxH): 425 × 330 × 260mm

Weight: 30.5kg

Laser safety features: Keyed interlock, emission delay, magnetic interlock, scan-fail safety, V-RAD 506 mechanical shutter | reaction time <20ms, adjustable aperture masking plate.

This laser system fully complies with the latest EN 60825-1, FDA regulations and TUV Laser Safety.

# Technical Specification [Atom 15]

## KVANT Atom 20 – full colour, semiconductor diode laser system

Total Optical Power (installed): 15W

Total Optical Power (guaranteed): 14.9W\*

Maximum Output Power: 15.2W

*\*Due to Advanced Optical Correction technology used in our laser systems the optical power output of each laser colour within the system may slightly differ from the specification of respective laser module(s) installed. This does not affect the guaranteed total power output.*

Colour	Wavelength	Output
Red	637nm	4800mW
Green	520nm	3600mW
Blue	445nm	6500mW

NOHD (Nominal Ocular Hazard Distance): 999m

Beam diameter at laser aperture: 5 × 5mm

Beam divergence: <1mrad (full angle)

Modulation: 0-5V analog, up to 50kHz

Module cooling: TEC

Scanning System:

Cambridge Technology CT6215 | 30kpps@8°, max. scanning angle 60° on both axes

Control signal: ILDA, Ethernet, ArtNet, SD Auto

Power requirements: 100-240V/50Hz (±5%)

Consumption: 500VA/100-240V

Operation temperature: 10-40°C

Ingress protection rating: IP54

Dimensions (WxDxH): 425 × 330 × 260mm

Weight: 30.5kg

Laser safety features: Keyed interlock, emission delay, magnetic interlock, scan-fail safety, V-RAD 506 mechanical shutter | reaction time <20ms, adjustable aperture masking plate.

This laser system fully complies with the latest EN 60825-1, FDA regulations and TUV Laser Safety.

# Technical Specification [Atom 20]

## KVANT Atom 20 – full colour, semiconductor diode laser system

Total Optical Power (installed): 20.6W

Total Optical Power (guaranteed): 20W\*

Maximum Output Power: 22.5W

*\*Due to Advanced Optical Correction technology used in our laser systems the optical power output of each laser colour within the system may slightly differ from the specification of respective laser module(s) installed. This does not affect the guaranteed total power output.*

Colour	Wavelength	Output
Red	637nm	6000mW
Green	520nm	3600mW
Blue	445nm	11500mW

NOHD (Nominal Ocular Hazard Distance): 999m

Beam diameter at laser aperture: 5 × 5mm

Beam divergence: <1mrad (full angle)

Modulation: 0-5V analog, up to 50kHz

Module cooling: TEC

Scanning System:

Cambridge Technology CT6215 | 30kpps@8°, max. scanning angle 60° on both axes

Saturn 5, 50kpps@7°, max. scanning angle 60° on both axes (optional)

Control signal: ILDA, Ethernet, ArtNet, SD Auto

Power requirements: 100-240V/50Hz (±5%)

Consumption: 500VA/100-240V

Operation temperature: 10-40°C

Ingress protection rating: IP54

Dimensions (WxDxH): 425 × 330 × 260mm

Weight: 30.5kg

Laser safety features: Keyed interlock, emission delay, magnetic interlock, scan-fail safety, V-RAD 506 mechanical shutter | reaction time <20ms, adjustable aperture masking plate.

This laser system fully complies with the latest EN 60825-1, FDA regulations and TUV Laser Safety.