



V-Force II Air Hockey Table



INSTRUCTION MANUAL

Air Hockey

by Brunswick

BASIC RULES

The object of the game is to score goals while preventing your opponent from doing the same. The person who scores ten (10) goals is the winner.

Starting player in all games is decided by a coin flip. Play begins with the starting player striking the puck towards his opponent's goal from any position behind the center line. Following a goal, the puck is put back into play by the person scored upon.

In the event that a player strikes the puck and causes it to leave the playing surface, his opponent is allowed a penalty shot at the other player's unprotected goal. The penalty shot must be "banked" off a side rail, from either of the two "face-off" circles, and not shot straight into the goal.

At no time while the puck is in play is a player allowed to touch the puck with his hand or trap the puck with his goalie. The goalie must always remain in contact with the playing surface and the player must have one foot on the floor at all times.

GAME VARIATIONS

2-Goalie

For singles only. Each player uses two goalies. One to defend and one in attack.

Multi-Cushion Solitaire

For one player. A great way to practice. Rebound shots off opposite end of table and score against yourself.

2-Puck

For singles or doubles. Play begins with each player striking a puck toward opponent's goal. Points are scored as in basic game.

Time Limit

For singles or doubles. Time limit is set at three 5-minute periods. Try to score as many goals as possible in that time limit.

Rebounds Only

For singles or doubles. All shots must rebound off at least one side to score.

King-of-the-Hill

For three players. Two against one. If single player scores, he maintains position. If the two players score, players rotate one position clockwise.

Doubles

Basic rules are followed.

Scotch Foursome

For doubles only. Alternate shots between you and your partner. Points are scored as in basic game.

PREVENTIVE MAINTENANCE

CLEANING

To keep the playing surface clean, vacuum as required. Turn the table blower on and vacuum with a soft brush head and wipe with a soft, dry cloth.

If soil marks cannot be removed with vacuuming, use an application of window cleaner, also with the blower on. Do not use a liquid cleaner on the playing surface with the blower off.

The pucks should be sanded smooth whenever they cease to float across the surface of the playing area. Simply place them on a sheet of sandpaper (220 grit) and move back and forth to eliminate any "burrs" or ragged edges.

Follow these recommended procedures to obtain optimum performance from your table.

AIR HOCKEY® LIMITED WARRANTY

NOTICE: THIS PRODUCT IS INTENDED FOR USE BY OR UNDER THE SUPERVISION OF ADULTS.

The Brunswick Corporation hereby warrants the Air Hockey® game to be free from defects in material and workmanship for a period of ninety (90) days from date of original purchase.

Should any defect in material or workmanship appear during such warranty period, the defective part will be repaired or replaced, at Brunswick's option, at no charge to the customer.











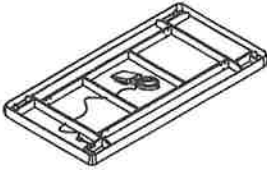

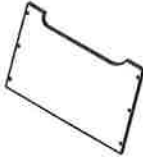

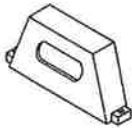
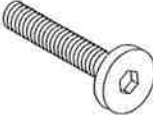
This game is not intended to be used in commercial or institutional locations.

Furthermore, this warranty does not include puck or goalies, nor does this warranty include damage due to vandalism or negligence.

For warranty requirements, contact the store or dealer from whom the game was purchased.

This warranty gives you specific rights, and you may also have other rights which vary from state to state.

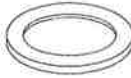
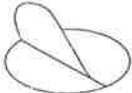
Parts List

<p>#1</p>  <p>Main Cabinet 1 Pc</p>	<p>#2</p>  <p>Left leg 2 Pcs</p>	<p>#3</p>  <p>Right leg 2 Pcs</p>	<p>#4</p>  <p>Leg panel 2 Pcs</p>
<p>#5</p>  <p>Strecher 2 Pcs</p>	<p>#6</p>  <p>Puck Catcher 2 Pcs</p>	<p>#7</p>  <p>5/16"X2-1/2" Bolt 12 Pcs</p>	<p>#8</p>  <p>5/16" Spring Washer 12 Pcs</p>
<p>#9</p>  <p>5/16" Washer 12 Pcs</p>	<p>#10</p>  <p>1/4"X1-1/8" Bolt 16 Pcs</p>	<p>#11</p>  <p>1/4" Washer 16 Pcs</p>	<p>#12</p>  <p>4x1" Screw 12 Pcs</p>
<p>#13</p>  <p>Pusher 2 Pcs</p>	<p>#14</p>  <p>Black Puck 2 Pcs</p>	<p>#15</p>  <p>Gray Puck 2 Pcs</p>	<p>#16</p>  <p>Sticker 2 Pcs</p>
<p>#17</p>  <p>Leg Leveler 4 Pcs</p>	<p>#18</p>  <p>Allen key 1 Pc</p>		

STEP 1:

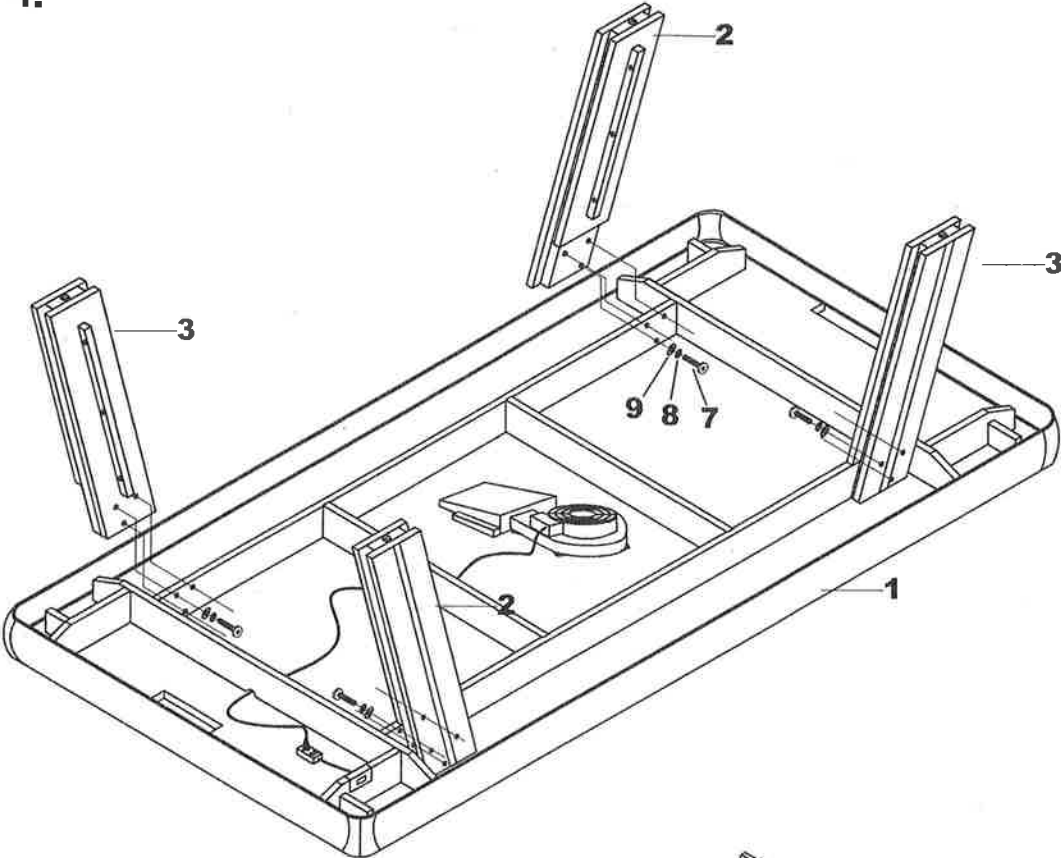

STEP 2:

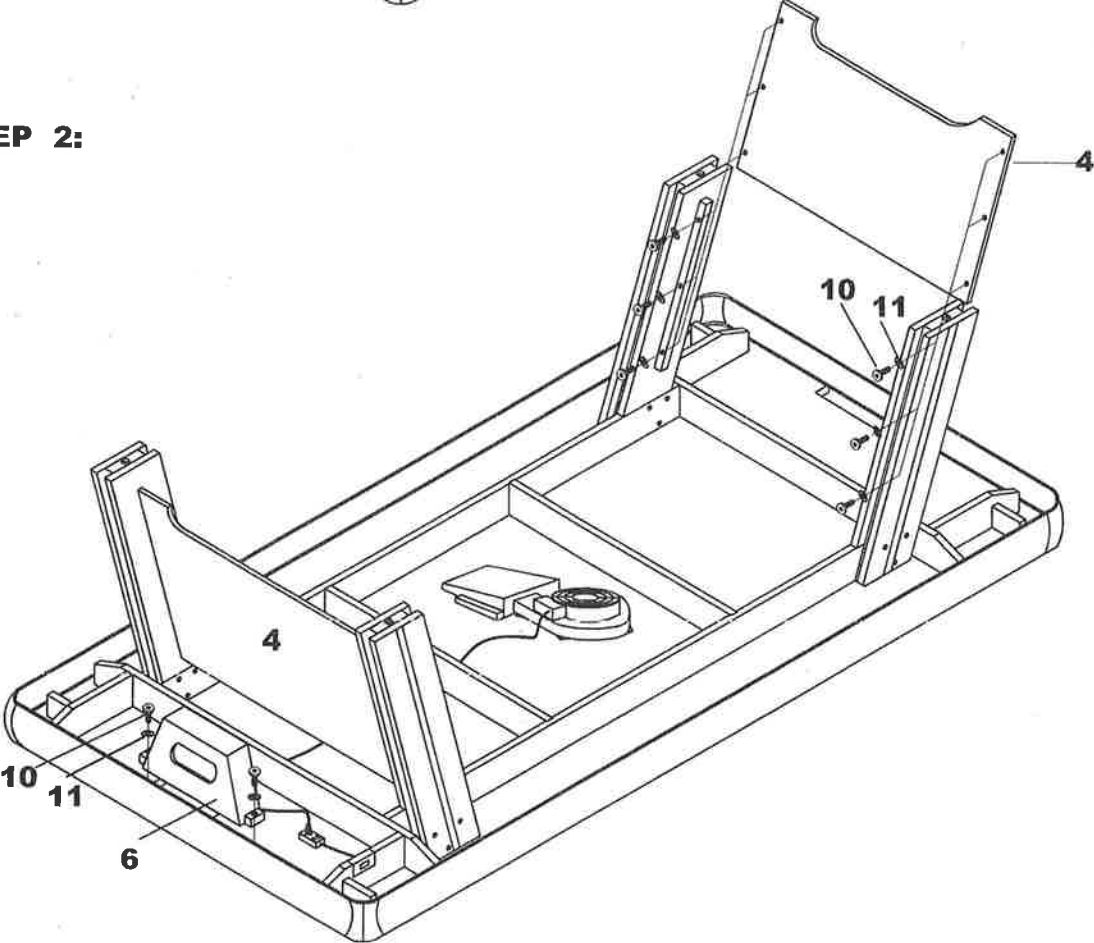

STEP 3:

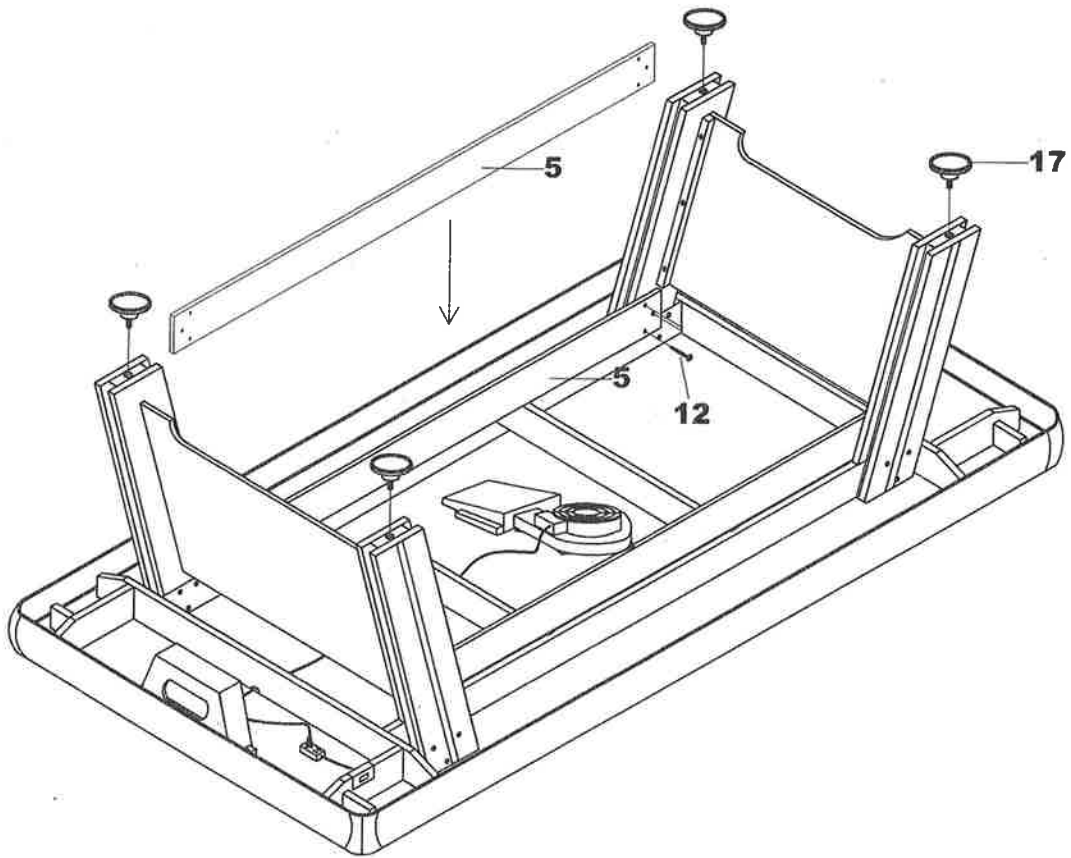

STEP 4:

