

ASSEMBLY INSTRUCTIONS



Tournament Foosball table

Model: FBTOCH



Congratulations on selecting a Playcraft Milan foosball table. Please contact us toll free at (888) 367-3095 or via email at support@playcraft.com should you require any assistance.



Please carefully read all safety instructions and directions before proceeding

- 1) Your table is designed for use indoors in a climate controlled environment only. Damage can occur if the table is exposed to water, dampness, high humidity, freezing temperatures, etc.
- 2) The foosball table is heavy. Two or more people are required for assembly.
- 3) Only use the table for its intended purpose.
- 4) Damaged or worn parts may be dangerous for users and the integrity of the table. Replace worn or damaged components immediately and do not use the table until any issues have been resolved. For best results, use only spare parts supplied by Playcraft.
- 5) Unauthorized repairs or altering the table's design or functions may be dangerous and will void the warranty.
- 6) Check all screws, bolts, etc. on a regular basis to ensure that they are in good working condition and have not loosened over time.
- 7) Please keep the balls, lubricant and other parts out of children's reach.
- 8) Don't spray the lubricant to any person or animal.
- 9) This is not a child's toy. Adult supervision is required for children playing this game.
- 10) please take care to avoid injuring any thing or person when you push and pull the player rods .





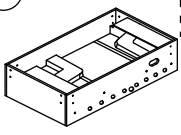
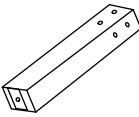
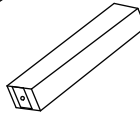
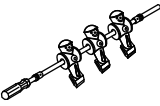
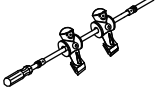
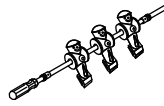

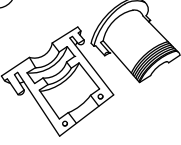
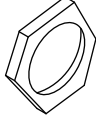
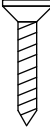
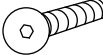
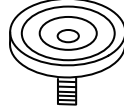
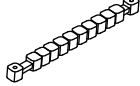

PARTS LIST

(Add a Check (✓) to the box to indicate receipt of each part.)

1		TABLE BODY 1438*756*400mm 1 PC	2		LEGS-LEFT 660*100*80mm 2 PCS	3		LEGS-RIGHT 660*100*80mm 2 PCS
4		GOALIE ROD 1086mm 2 PCS	5		2 PLAYERS ROD 1254mm 2 PCS	6		3 PLAYERS ROD 1124mm 2 PCS
7		5 PLAYERS ROD 1010mm 2 PCS	8		BEARINGS Ø57*48.5mm 18 PCS	9		BEARING NUTS 57*6mm 18 PCS
10		SCREWS F4*35mm 4 PCS	11		BOLTS 10*65mm 16 PCS	12		LEG LEVELERS Ø90*50mm 4 PCS
13		SCORER 300*25*21mm 2 PCS	<p>NOTE: There are 8 sets of Bearings (#8 & #9) have already been attached on the Table Body(#1).</p>					

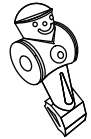
ADDITIONAL PRE-INSTALLED PARTS. (FOR REFERENCE ONLY.)

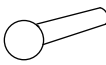
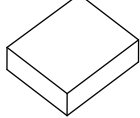
14		TOOLS 1 SET	15		SOCCER BALLS Ø35mm 8 PCS	16		LUBRICANT 50ml 1 PC
17		ROLL PIN 4.2*35mm 6 PCS	18		ROLL PIN 4.2*28mm 2 PCS	19		PLAYER 108*35mm 2 PCS
20		BOLTS 10*65mm 2 PCS	21		ROLL PIN PUNCH 4*80mm 1 PC	22		MATERIAL SAMPLE 1 PC



ASSEMBLY INSTRUCTIONS:

We recommend that two adults work together to assemble this table.

- The table must be turned over before assembling its Legs, then turn it over again to assemble player rods .
- We suggest that you use the packing EPE as clean flat work area to protect the table.

FIG. 1

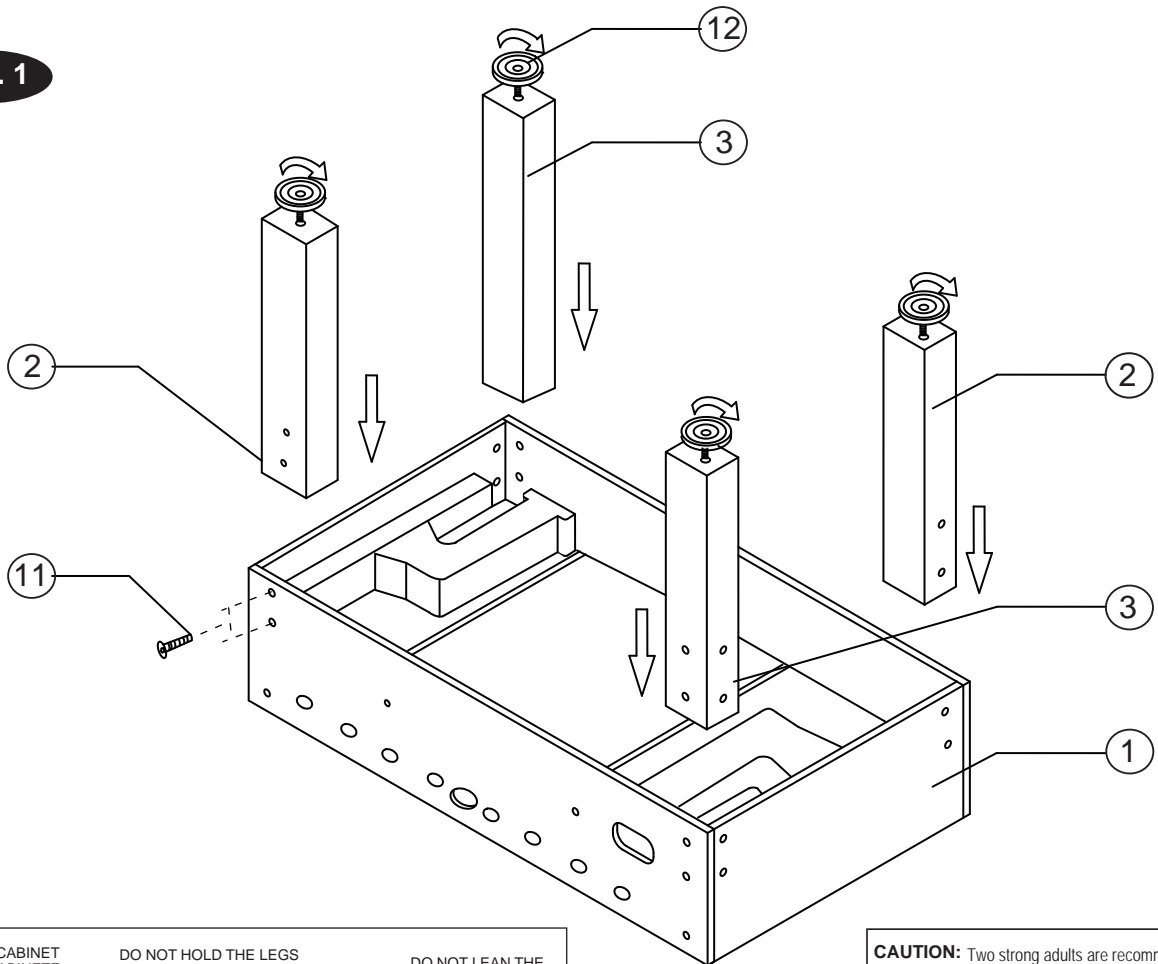

CAUTION: Two strong adults are recommended to turn the table over as shown.

1. Lift the table off the ground.
2. Turn the table over.
3. Place it on all four feet at the same time on the ground.

FIG. 1: LEG ASSEMBLY

- Attach the Legs (#2 & #3) between the Side and End Aprons with four Bolts (#11) per Leg as shown in Fig.1. Use the Allen Key (#14) provided.

NOTE: Please twist the four Bolts(#11) into one leg at the same schedule when you assemble the Legs . (Don't twist the Bolts very tightly at once .) .

- Insert the Leg Levelers (#12) into the bottom of the Legs (#2 & #3) . See Fig.1.
- Lift the table assembled from the floor by two strong adults,turn it over, and set table on its legs in the location where you will play.



FIG. 2

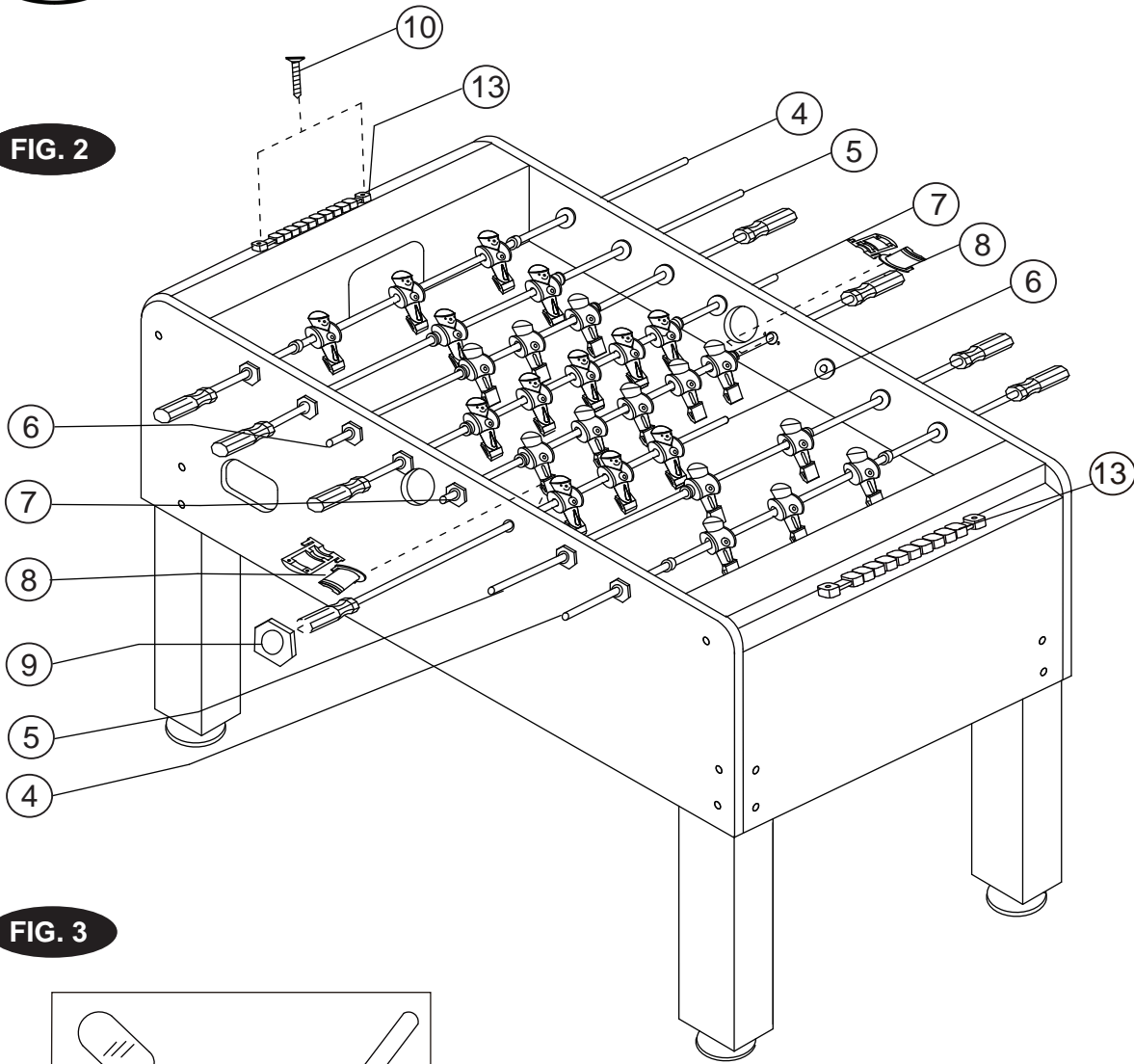

FIG. 3

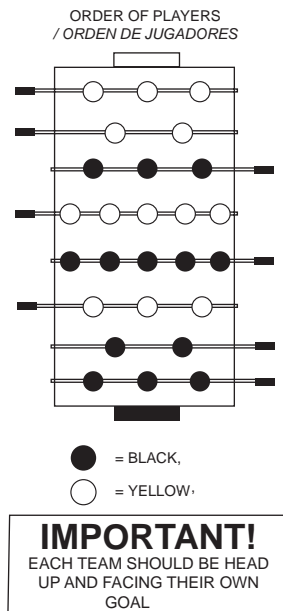
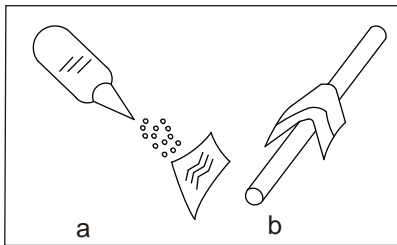

FIG. 2: PLAYER / BEARING / SCORER ASSEMBLY

- Carefully slide the grip end of Player Rod (#6) through the inside of Side Apron to outside (until the Player touch the Side Apron) , then slide another end of the Player Rod (#6) through the directly opposite hole in the opposite Side Apron .
- Slide the Player Rods(#4-#7) through the Side Apron in the order shown . See Fig .2 .
- Attach all the Bearings in the accessory kits to the Side Aprons as shown Bearing (#8) in Fig.2.
- Attach the Scorer Assemblies(#13) in the middle of each Top Slat Board using two Screws(#10) per Scorer.See Fig.2 .
- Spray the Lubricant (#16) in a clean , soft cloth first , then use this cloth to wipe the Player Rods . See Fig.3 .



TABLE MAINTENANCE	
TABLE SURFACE	Keep your table covered . If there is dust on the playfield or the aprons , use a vacuum or wipe with a clean , soft cloth to remove . Do not sit on the table and do not use the table outside .
RODS	Occasionally wipe the rods with a clean , soft cloth . Never lift the table by the rods . Do not spin or press the rods too aggressively , as this may cause damage . We recommend the use of lubricant to wipe the Player Rods and Bearings from the outside of the game so as not to drip onto the playfield .
LEGS	Check that the leg bolts are tight. When moving the table, lift table off of its legs and place it down squarely on the legs, do not drag the table .

FIG.4

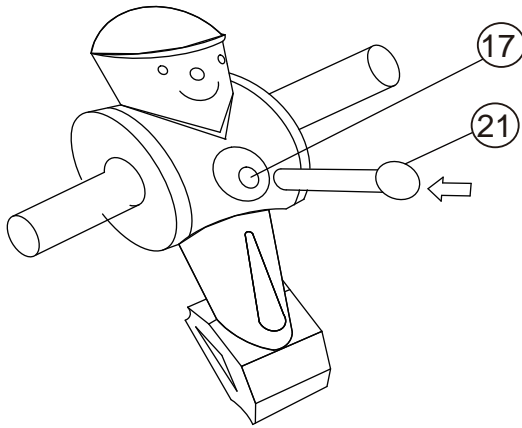

FIG. 4: PLAYER MAINTENANCE

- Take down the Player Rod ,knock the Roll Pin (#17) out , then attach the spare Players and Roll Pin to this Player Rod . See Fig.4. Use the Roll Pin Punch (#21) provided .



Basic Foosball Rules

Flip A Coin - A coin flip decides who serves the foosball to start the foosball game. After the first goal is scored, the rule is that the team who was last scored on gets to serve the next ball. This rule keeps the game fair for both opponents. The foosball must be touched by a man before the ball goes into a goal for a legal goal to occur.

No Spinning - A spin is a rule for when the rod completes a 360 degree rotation without touching the ball. This is deemed an illegal move in the rules of foosball.

No Jarring - Jarring is a rule for when a player slams his or her rods against the wall of the foosball table in an attempt to distract or jar the foosball loose from the other player's possession. The rule is that there is no jarring allowed at any point during a game. This is not the same as when a player on the opposite team moves his or her foosball rods back and forth in an attempt to play defense. The key this rule is when a player hits the wall of the table with enough force to jar the ball or distract the opponent. That is why this is a subjective rule that may be called more strict by certain foosball players.

Dead Balls - If a foosball stops in the middle of two opposing team rods, the ball must be picked up and reserved. The serve goes back to the team that was last scored on. If a dead ball occurs on the defensive side of the table behind the defensive 2 bar, the defensive player must move the ball back into playing position. This rule is in place so players don't cause a dead ball on purpose in order to force a reserve.

Out of Play - If a ball comes off the table area or hits a top rail and comes back into the table area, the ball is ruled out of play and must be reserved by the team that was last scored on.

5 Bar Passing - These 5 bar passing rules are a little complex if you have never played tournament foosball. These passing rules do not apply to the other foosball rods, just the 5 bar. You are required to pass the ball within a 10 second time period from your 5 bar rod to the 3 bar rod directly after a serve. After the initial serve, you then are allowed 15 seconds to pass from the 5 bar. A ball cannot be completely stopped on the 5 bar and passed forward to the 3 bar, it must be moving and touch 2 men on the 5 bar before being advanced. Additionally, the ball can only touch the wall a total of 2 times in a row (before touching a man again on the 5 bar) before being advanced. However, it can touch the ball a 3rd time if it is part of the pass.



Customer Service

For questions on assembly or for missing or damaged parts, please contact us toll free at (888) 367-3095 or via email at support@playcraft.com. Please visit our website at www.playcraft.com to see more industry leading Playcraft and Playcraft Sport game tables.

Thank you for choosing Playcraft!

Global Merchants, Inc.
12 Lunar Drive
Woodbridge, CT 06525