

D

Montage- und Bedienungsanleitung

D

GB

Instructions for Assembly and Use

GB

F

Instructions de montage et d'utilisation

F

NL

Montage- en bedieningshandleiding

NL

E

Instrucciones para el manejo y uso

E

CZ

Návod k sestavení a použití

CZ

PL

Instrukcja montażu i użytkowania stołu

PL

H

Szerelési és kezelési útmutató

H

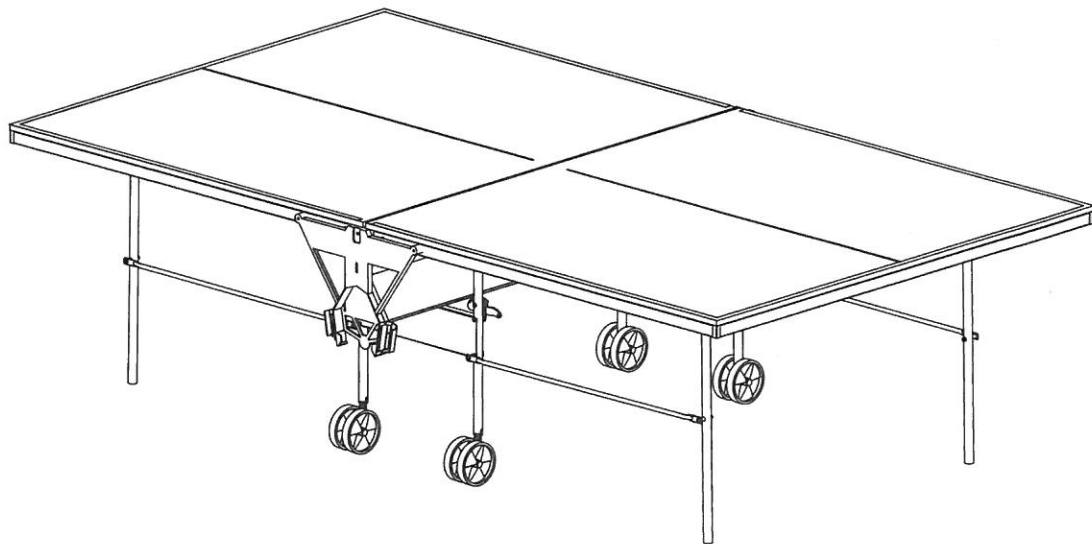

MA 211.4-7 - v.29.07.03-03

D

Vor der Montage und der ersten Benutzung lesen Sie bitte die Montageanleitung und die Benutzerinformationen sorgfältig durch. Sie erhalten wichtige Hinweise für Ihre Sicherheit beim Gebrauch des TT-Tisches. Bewahren Sie die Anleitungen zu Ihrer Information, Instandhaltung und Ersatzteilbestellung auf, solange Sie den TT-Tisch nutzen.

- Montieren Sie den TT-Tisch mit mindestens **2 erwachsenen Personen** auf einer sauberen und weichen Unterlage.
- Sortieren Sie das Zubehör nach Liste und kontrollieren Sie auf Vollständigkeit.
- Folgen Sie bei der Montage der angegebenen Reihenfolge der Montageschritte: A, B, C, ... usw.
- Lesen Sie bei **Textmarken** die Erklärungen auf Seite **III**.
- Orientieren Sie sich bei **Teilemarken** anhand der Teileliste auf Seite **V**.
- Verwenden Sie die bei den Montageschritten angegebenen **Werkzeuge**.

Textmarke



Teilemarke



Werkzeug

**GB**

Before starting to assemble the tt-table and before using it for the first time please read the Assembly Instructions and the Information for the User very carefully. They contain important advices for safety when using the table. Please keep the instructions for your information, for maintenance and for ordering spare parts as long as you use the tt-table.

- At least **two adults** have to participate in the assembly of the tt-table which should be carried out on a clean and soft floor.
- Before commencing the assembly, check all the parts according to the Parts List and make sure that they are all present and correct.
- Please follow the ABC references for the order of the assembly.
- If there is a **text mark**, please read the explanation on page **III**.
- If there is a **part mark**, please read the information relating to it in the Parts List on page **V**.
- Please use the **tools** as indicated for each of the assembly stages.

Text mark



Part mark



Tool

**F**

Avant le montage et la première utilisation de la table de ping-pong, lire attentivement les instructions de montage et d'utilisation. Elles comportent des renseignements importants pour votre sécurité sur l'utilisation de la table de ping-pong. Veuillez conserver ces instructions pour votre information, pour l'entretien et la commande de pièces détachées, tant que vous utiliserez la table de ping-pong.

- Le montage de la table de ping-pong nécessite l'intervention de **deux adultes** au moins et doit avoir lieu sur une surface propre et sans aspérités.
- Veuillez trier les pièces détachées en fonction de la liste et vérifier qu'elles sont fournies dans leur intégralité.
- Veuillez suivre, lors du montage de la table de ping-pong, les instructions de montage dans l'ordre indiqué : A,B,C, ... etc.
- Les explications des **symboles** se trouvent en page **III**.
- Le détail de la **numérotation** des pièces figure en page **V**.
- Veuillez utiliser les **outils** indiqués pour les différentes étapes du montage.

Symboles



Numérotation



Outils

**NL**

Voordat u met de montage van de tafeltennistafel begint, en deze voor de eerste keer in gebruik neemt, gelieve eerst de montagehandleiding en gebruikershandleiding zorgvuldig door te nemen. Deze handleidingen bevatten belangrijke informatie omtrent uw veiligheid, bij het gebruik van de tafeltennistafel. We vragen u dan ook de handleidingen inzake onderhoud en bestelling van reserve onderdelen, zo lang te bewaren als u gebruikt maakt van de tafeltennistafel.

- Ten minste **twee volwassen personen** dienen de tafeltennistafel te monteren op een schone en zachte ondergrond.
- Controleert u aub of alle onderdelen compleet aanwezig zijn volgens de lijst.
- Gelieve de aangewezen volgorde aan te houden bij de montage van de tafeltennistafel: A,B,C etc.
- Als er een **tekst aanduiding** is gelieve de verklaring, daarvan terug te lezen op blz. **III**.
- Als er een **onderdeel aanduiding** is informeert u hierover op blz. **V**.
- Gelieve de aangewezen **gereedschappen** te gebruiken, bij de diverse montage onderdelen

tekst
aanduidingonderdeel
aanduiding

gereedschap



E

Antes de empezar a montar la mesa, y antes de usarla por primera vez, por favor leer las instrucciones de manejo y la información para el uso muy cuidadoso. Contienen avisos importantes de seguridad para el uso de la mesa. Por favor sigue las instrucciones para tu información, para el mantenimiento y para ordenar las partes de más, a lo largo del uso de mesa.

Cuando **dos adultos** tengan que montar la mesa, deberían llevarlo a cabo en un suelo limpio, y blando.

Antes de empezar el manejo, comprueba que todas las partes estén como en la lista, y comprueba que están todas, y que están correctas.

Sigue las instrucciones de las referencias ABC, para el orden del montaje.

Si hay una **nota en el texto**, lee la explicación de la página **IV**.

Si hay una **marca a parte**, lee la información relacionada con ella, en la lista en la página **V**.

Utiliza las **herramientas** como indicamos para cada etapa del manejo.

nota en el texto



marca a parte

13

herramienta

**CZ**

Před prvním použitím si prosím přečtete pozorně návod k použití. Instrukce obsahují důležité body týkající se bezpečnosti při používání pingpongového stolu. Prosím, uchovejte návod k použití co nejdéle pro vaši informovanost, sestavení a objednání náhradních dílů.

- Sestavení pingpongového stolu za pomoci minimálně dvou dospělých osob na čistém a měkkém povrchu.
- Zkontrolujte všechny díly a součástky pingpongového stolu dle seznamu.
- Při samotném sestavování pingpongového stolu dodržujte prosím postup: A,B,C,..... atd. tak, jak je uvedeno v návodu.
- V případě jakékoliv **značky v textu** si prosím přečtete instrukce na str. **IV**.
- V případě jakékoliv části **dílů** se prosím informujte na str. **V** seznam dílů.
- Použijte uvedené **nářadí** s odlišným postupem použití.

textová značka



značka dílu

13

nářadí

**PL**

Zanim rozpoczniesz montaż i używanie stołu zapoznaj się uważnie z treścią instrukcji i zawartymi w niej wskazówkami. Instrukcję zachowaj w celu prawidłowej eksploatacji stołu i ewentualnej wymiany części.

- Montaż stołu powinny prowadzić, co najmniej dwie osoby. Stół montuj na płaskim i równym podłożu.
- Przed montażem sprawdź z wykazem, czy nie brakuje któregoś z elementów.
- Etapy montażu przedstawione są na rysunkach oznaczonych w kolejności ci A, B, C, ...
- Jeżeli na obrazku znajduje się w lewym górnym rogu **znak odsyłający** cy zapoznaj się z treścią objaśnienia umieszczonego na stronie **IV**.
- **Element** na rysunku oznaczony czarnym kwadracikiem z cyfrą jest pokazany w powiększeniu na stronie **V w wykazie** części.
- Do montażu używaj tylko **narzędzi** przedstawionych na rysunku.

Znak odsyłający



Element w wykazie

13

Narzędzie

**H**

A szerelés és az első használat előtt tanulmányozzák át gondosan a szerelési útmutatót és a felhasználó számára szolgáló tájékoztatásokat. Ezek a pingpongasztal használatával kapcsolatos, a személyes biztonságot szolgáló fontos tudnivalókat tartalmaznak. A tájékozódáshoz, karbantartáshoz és alkatrészrendeléshez szükséges dokumentációt őrizzük meg mindaddig, amíg a pingpongasztalt használjuk.

- A pingpongasztal tiszta és puha alapra történő felállításához legalább 2 felnőtt személyre van szükség.
- Válogassuk szét a tartozékokat a jegyzék szerint, és ellenőrizzük, hogy megvan-e minden.
- A szerelés során a megadott sorrendben végezzük el az egyes műveleteket (A, B, C ... stb.).
- A **szövegben** szereplő **jelzések** magyarázatát lásd a **IV**. oldalon.
- Az egyes részek jelöléseinek történő eligazodáshoz a **V**. oldalon található **alkatrészjegyzék** nyújt segítséget.
- A szerelési műveleteket a megadott **szerszámokkal** végezzük el.

Szöveges jelzés



Alkatrész-jelzés

13

Szerszám



A 4x

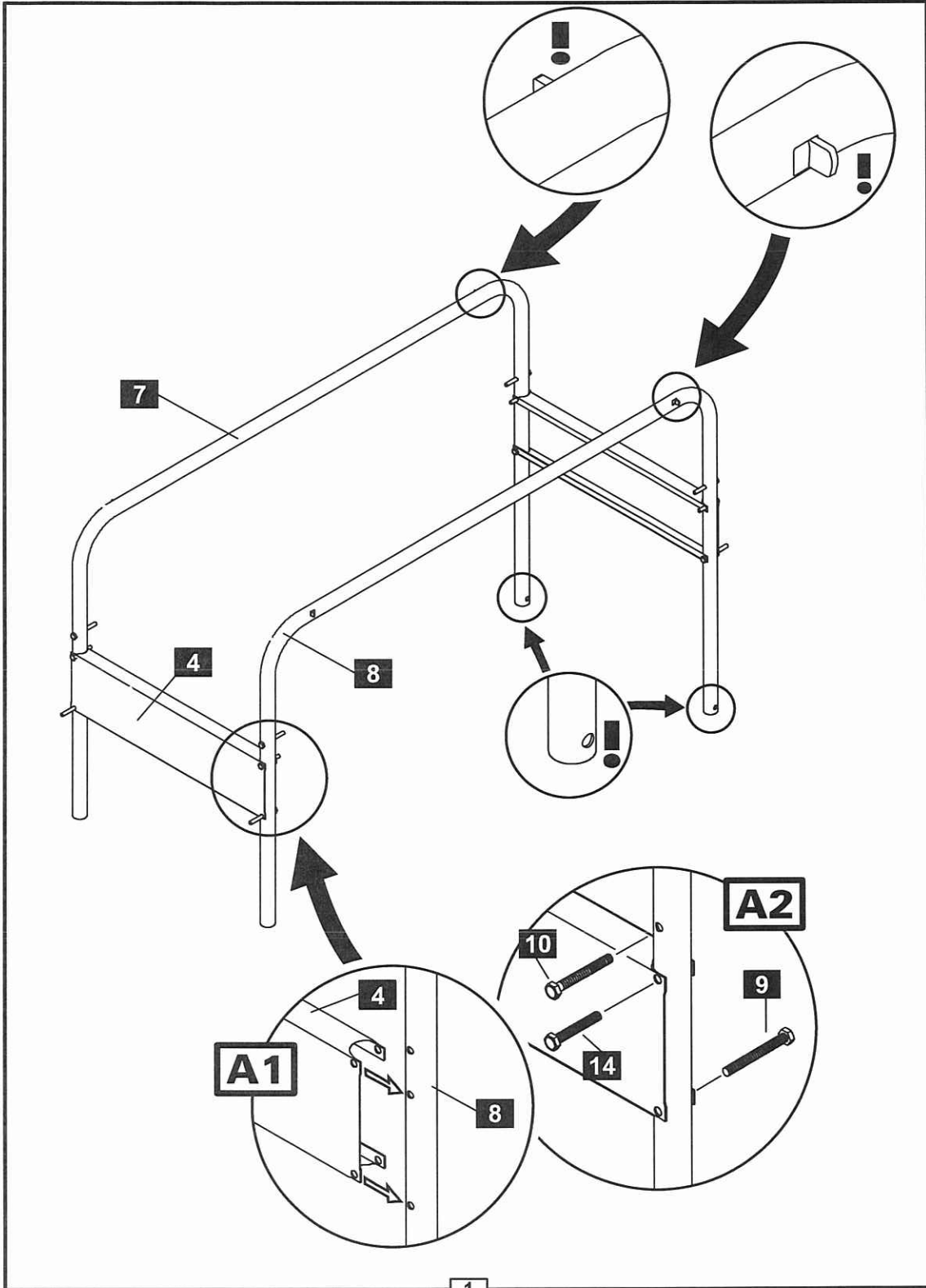

1

B 4x

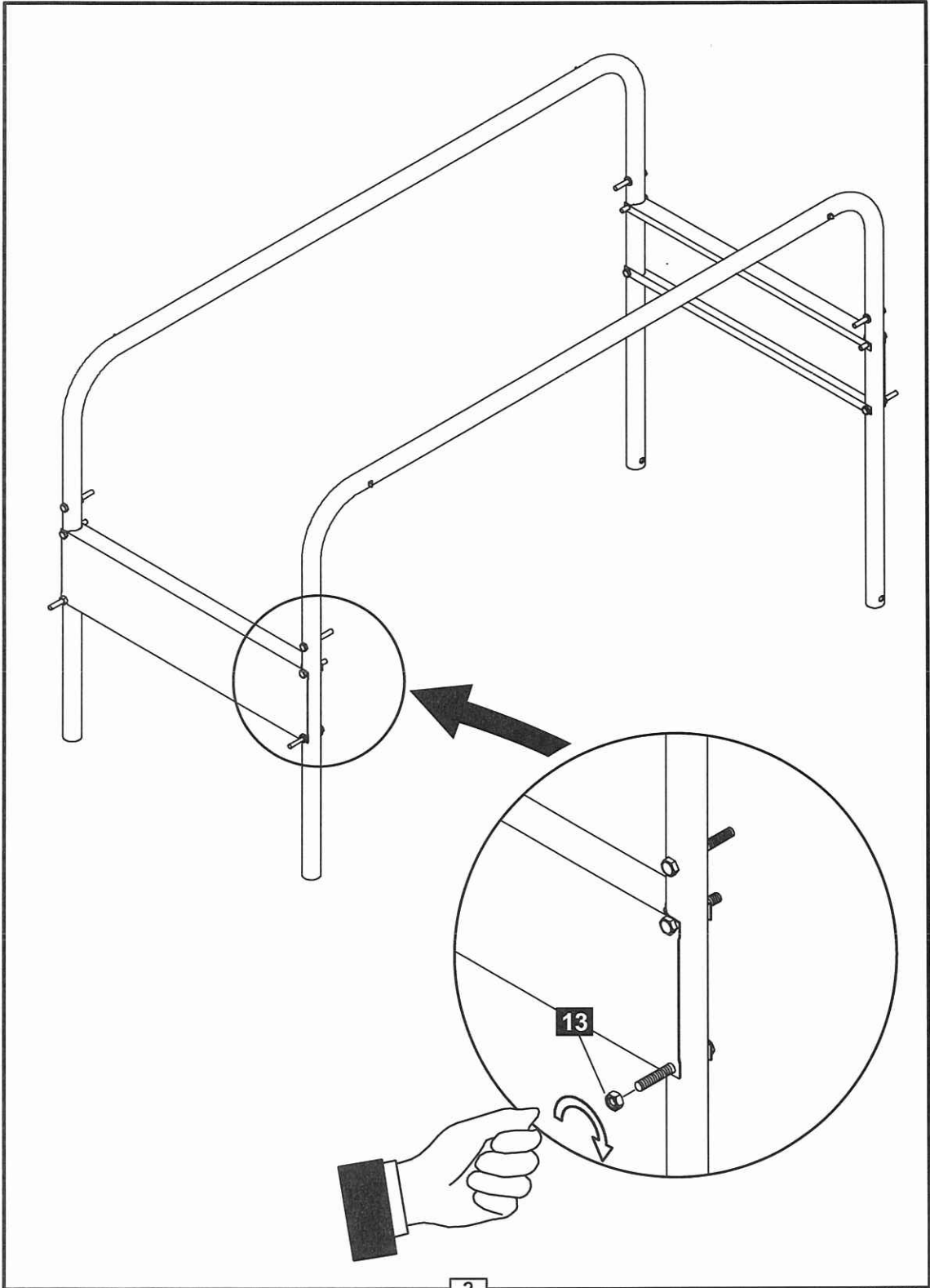

2

MA 211.4-7

C 4x

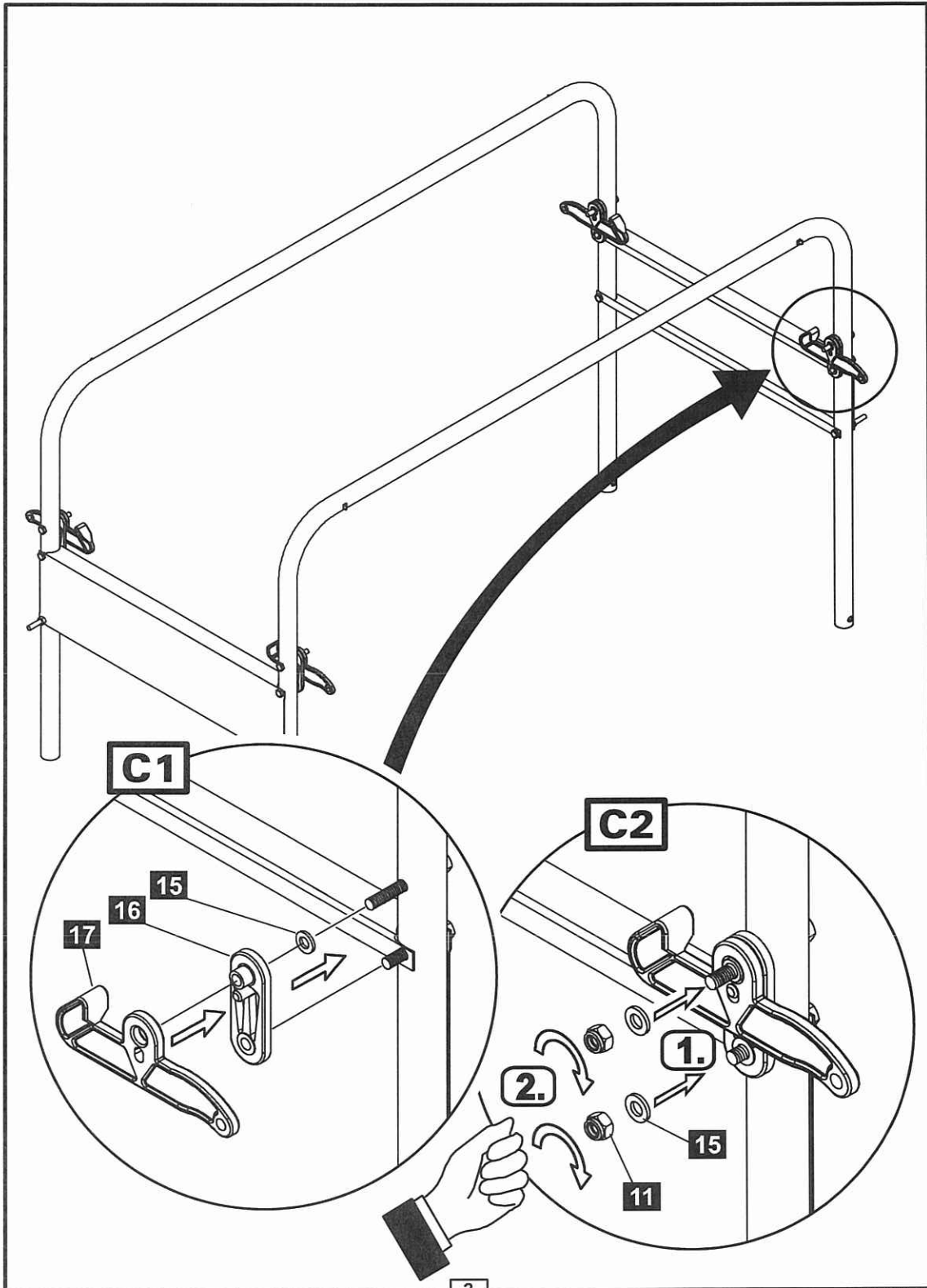

3

D 4x

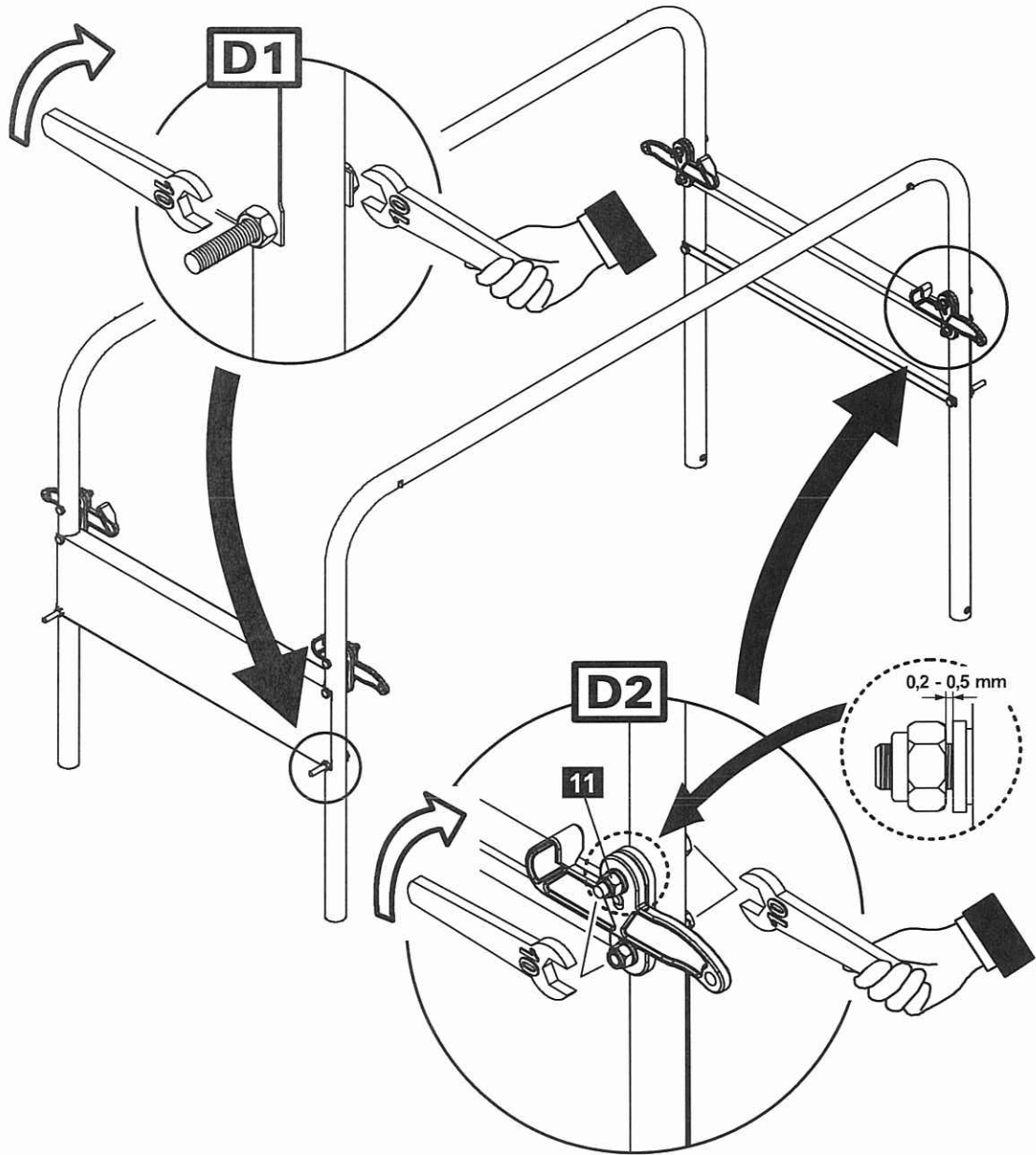

E **2x**

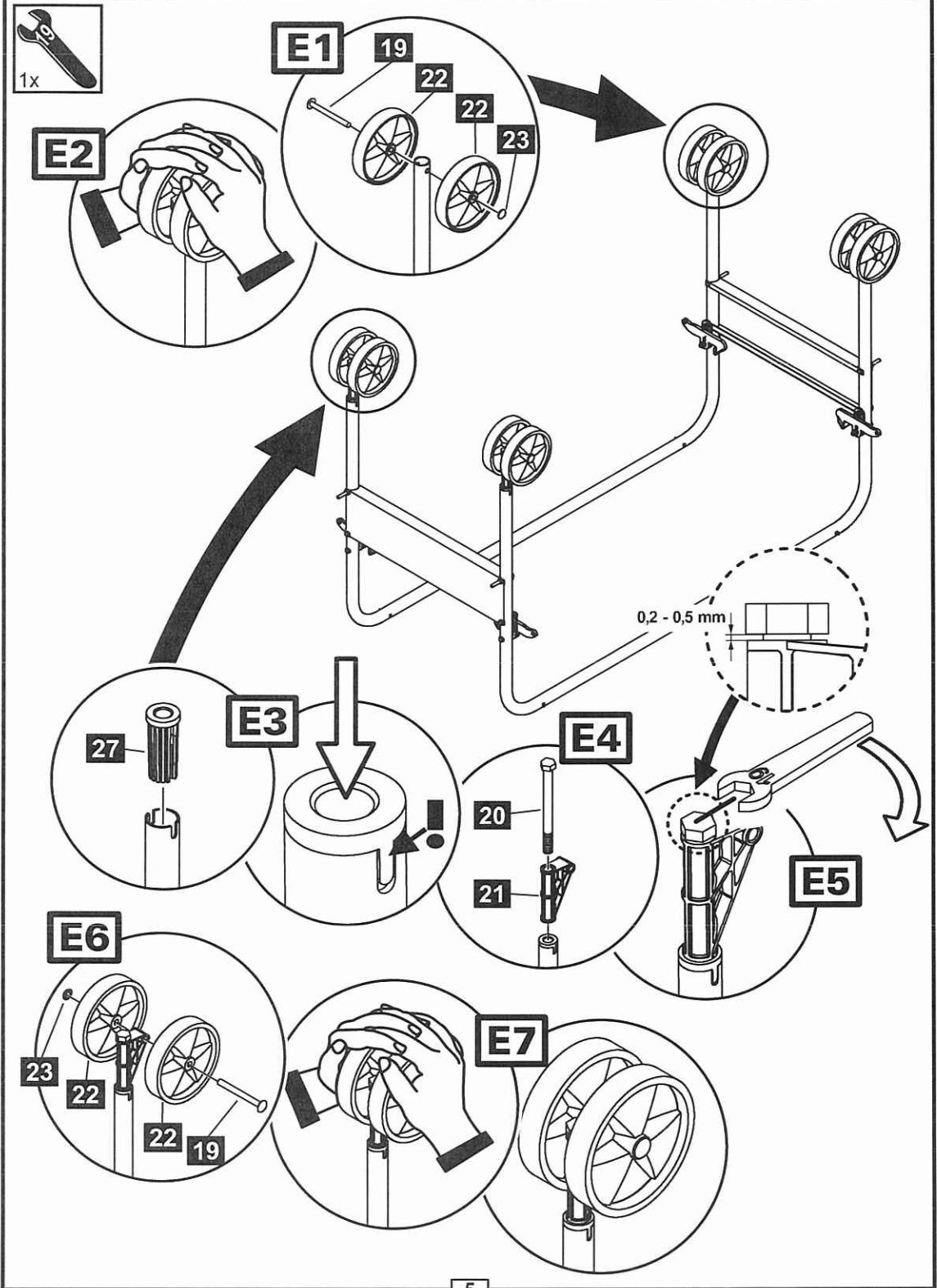

F **2x**

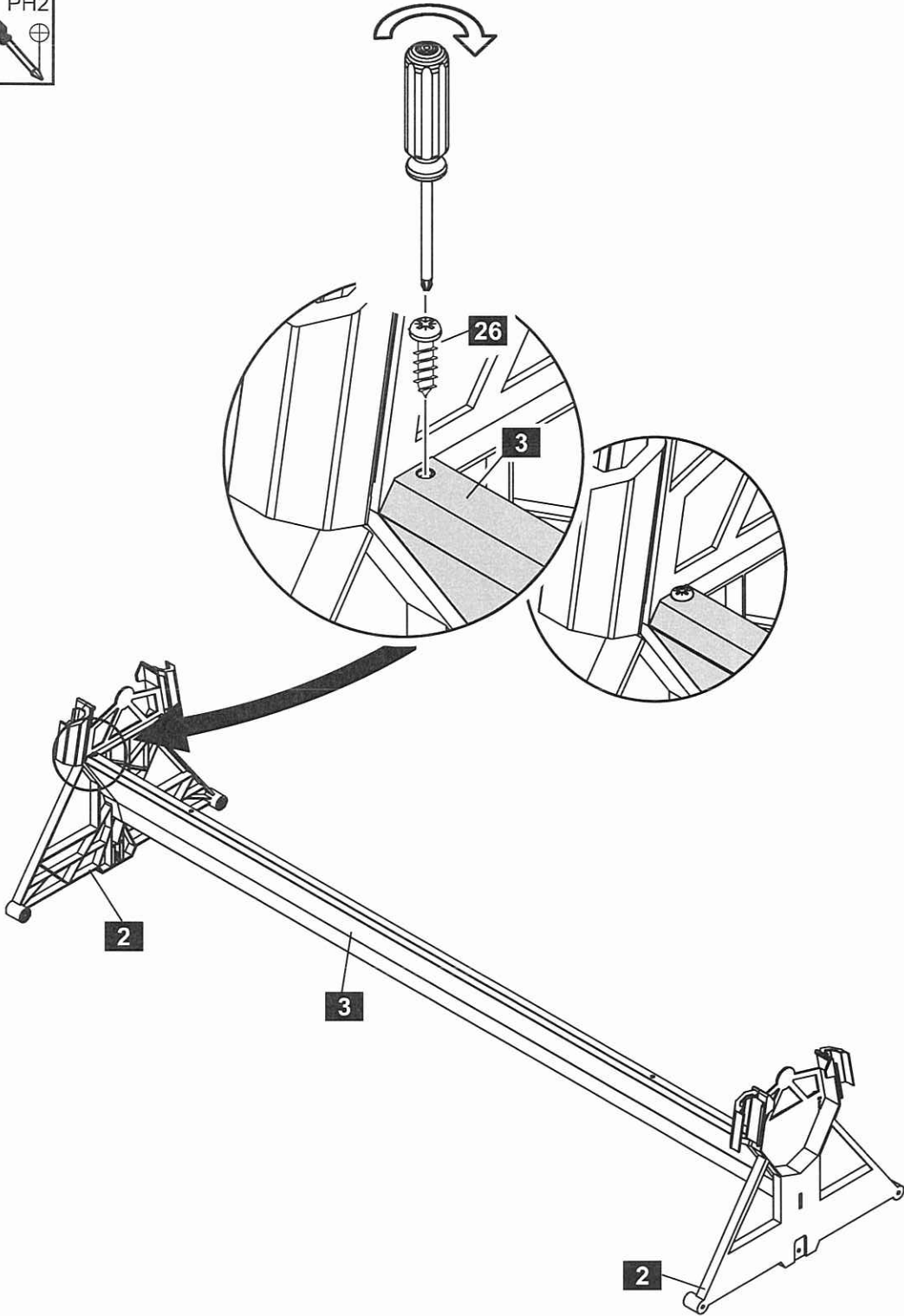

6

G 2x

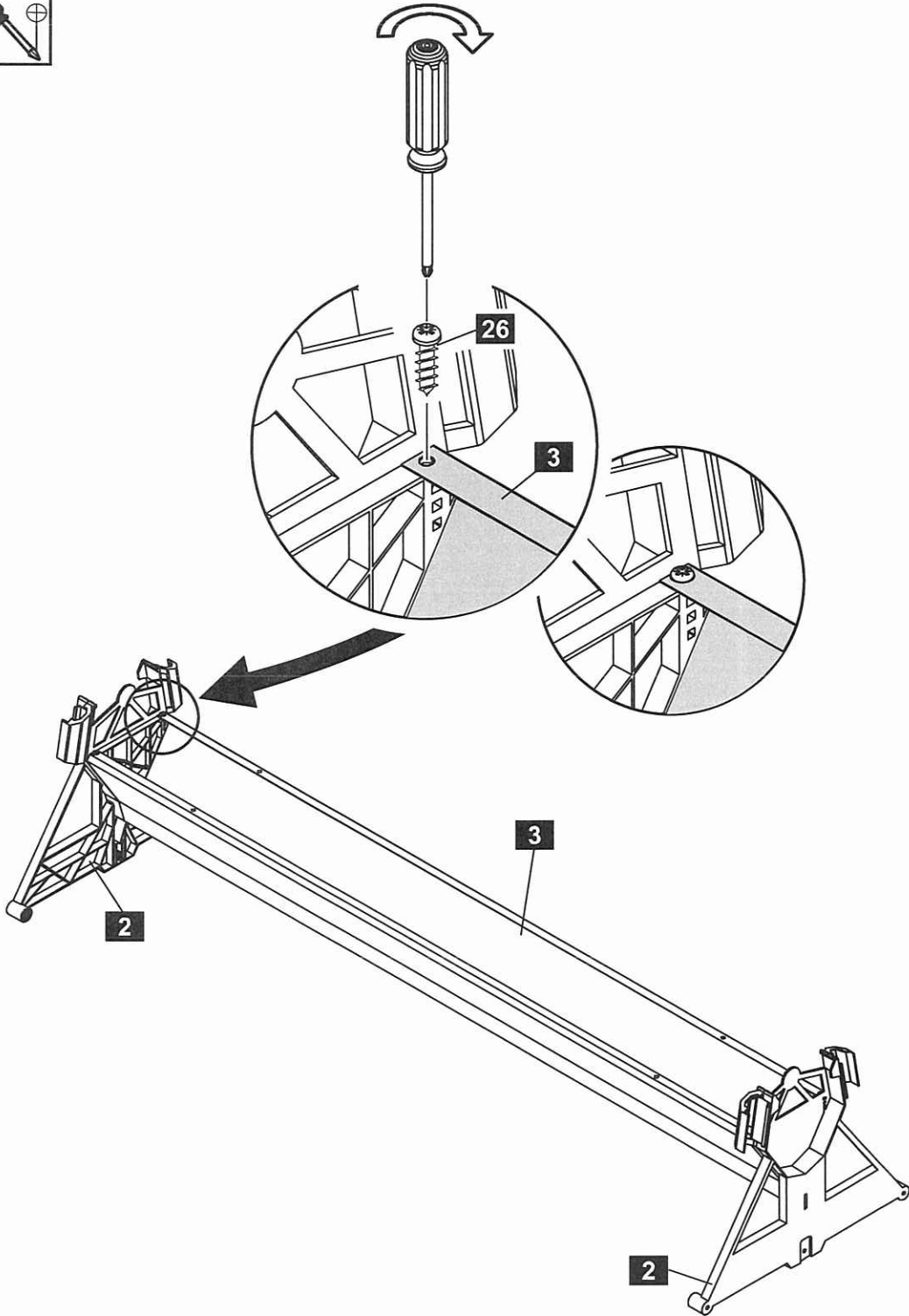

7

H **2x**

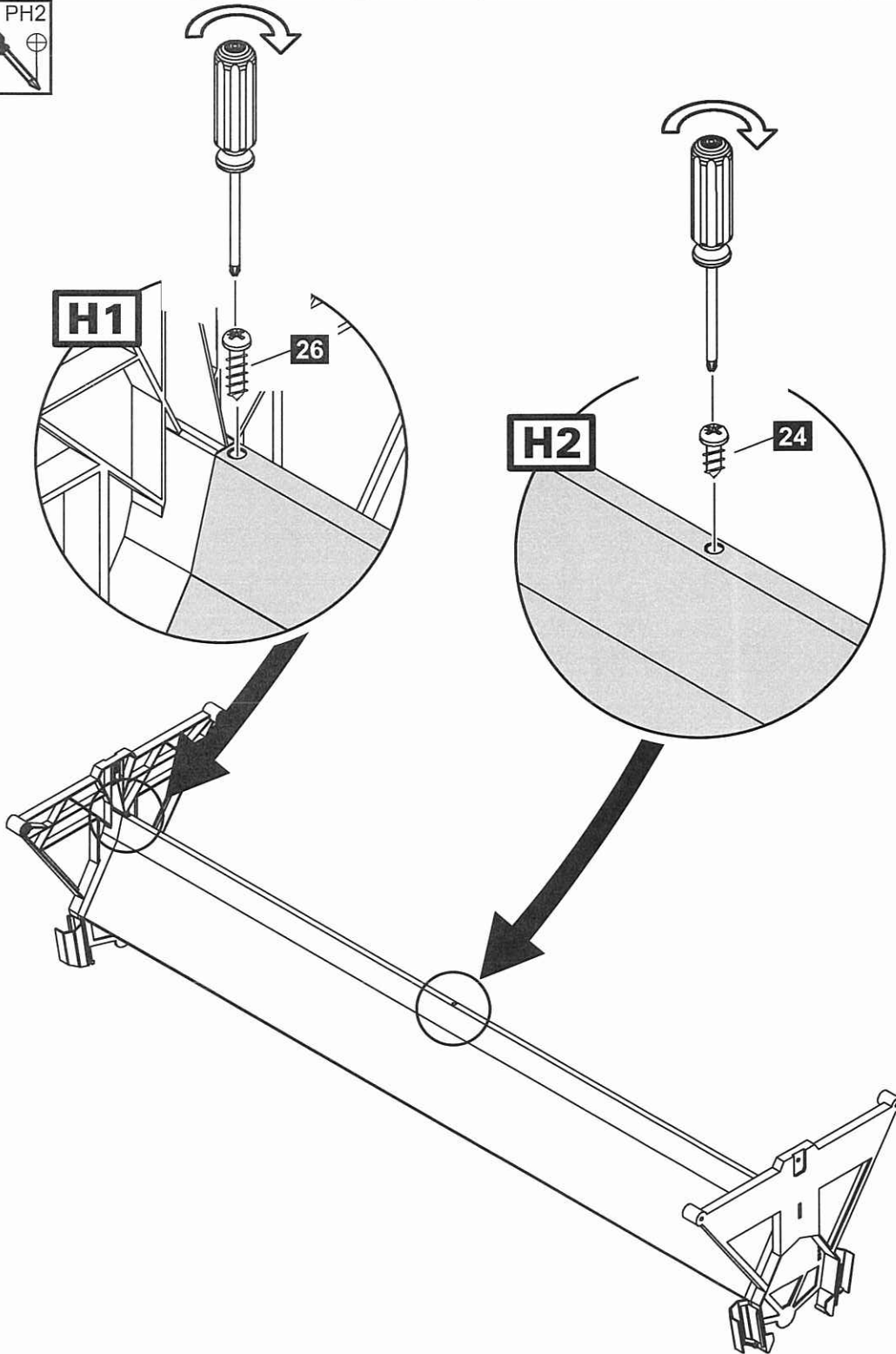

2x

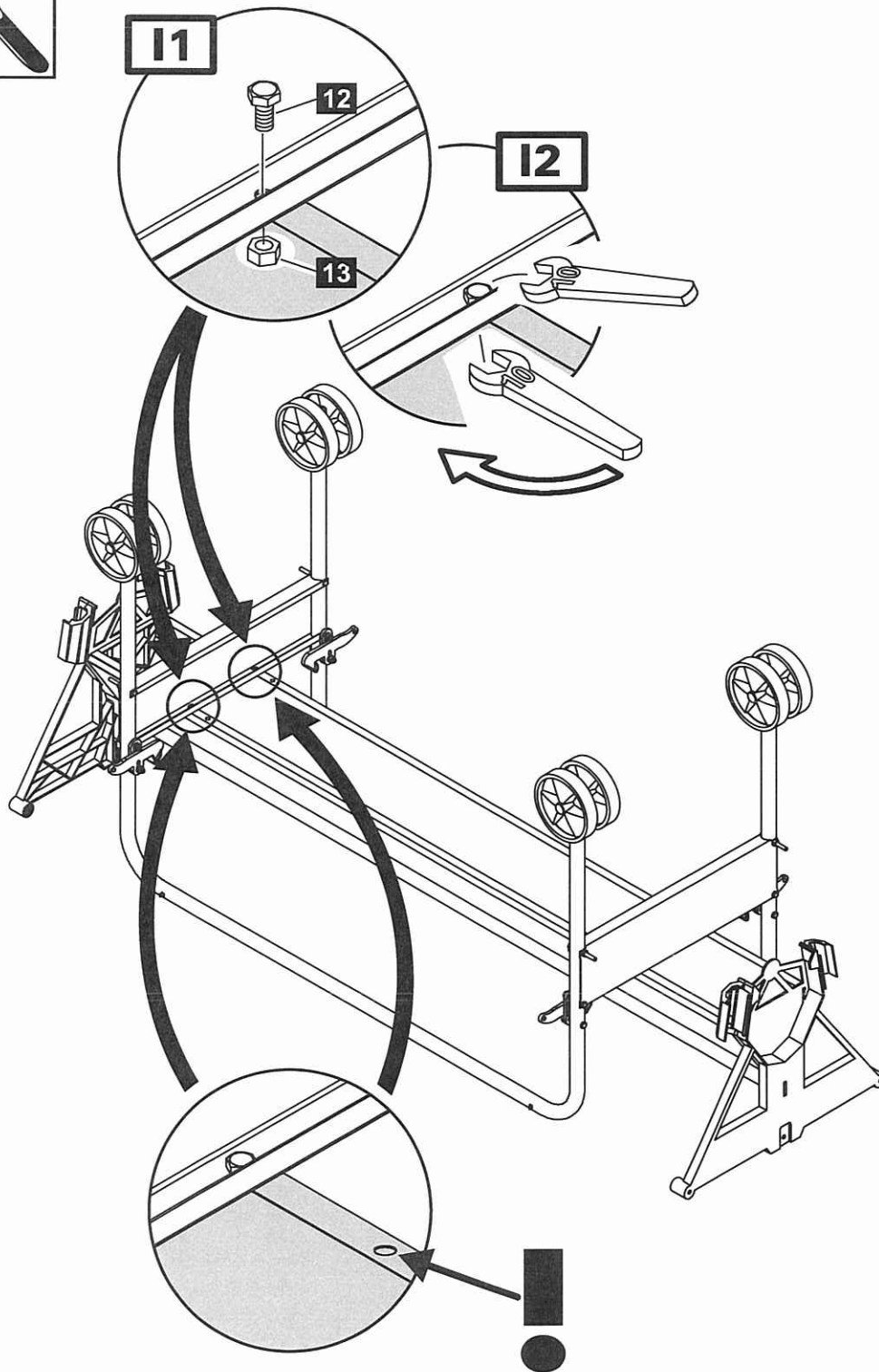

9

MA 211.4-7

J **2x**



J1

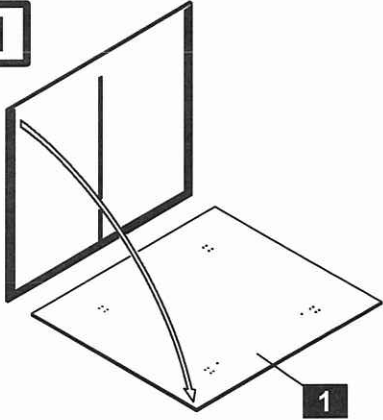

J2

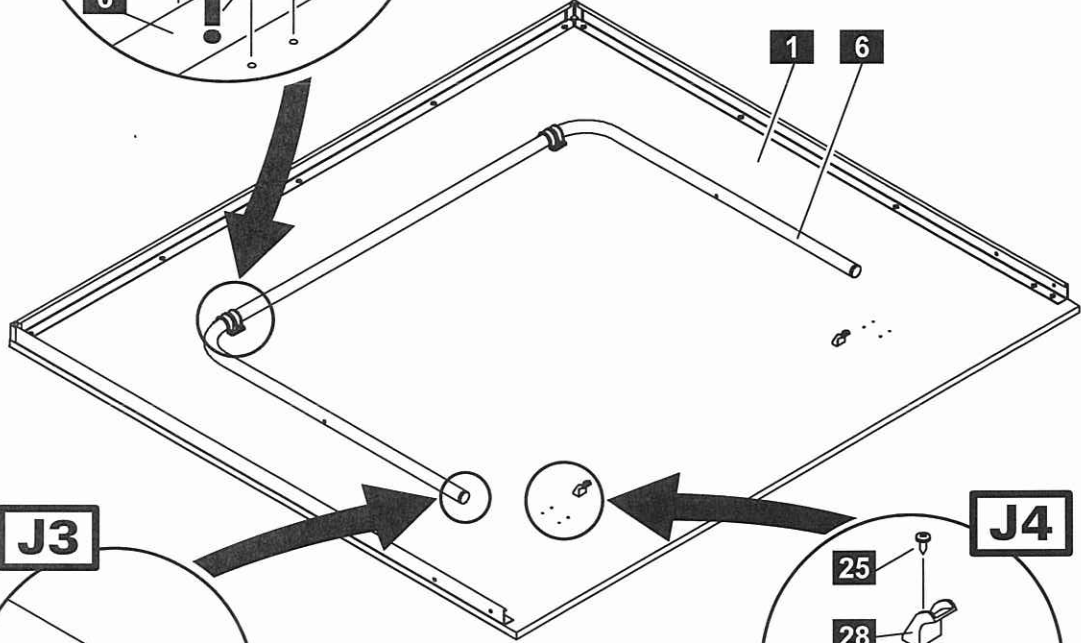
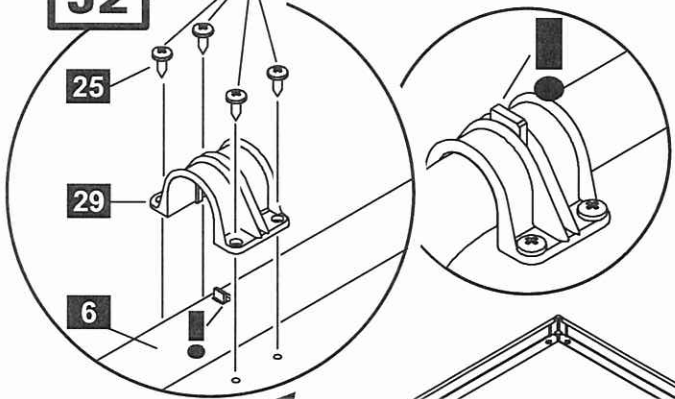

J3

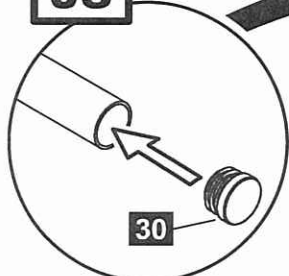

J4

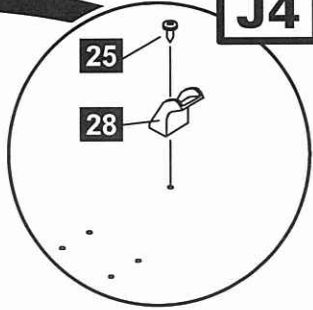

K



K1

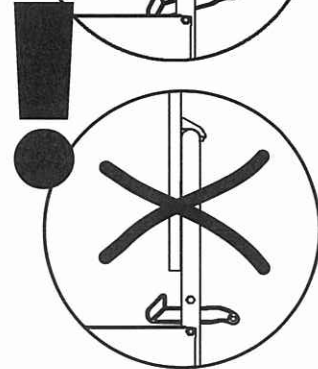
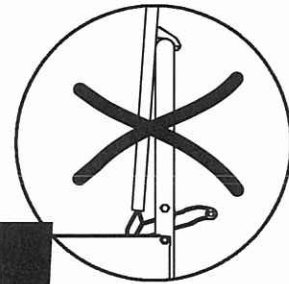
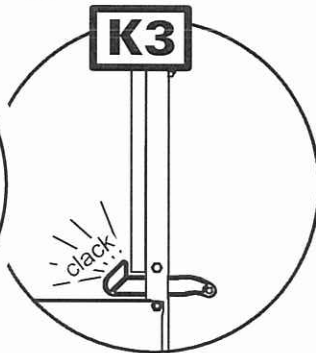
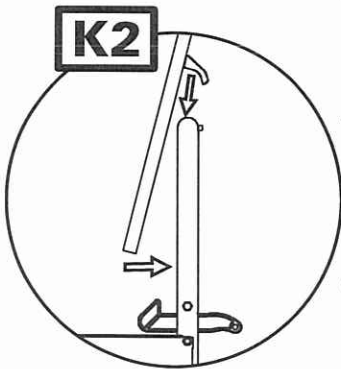
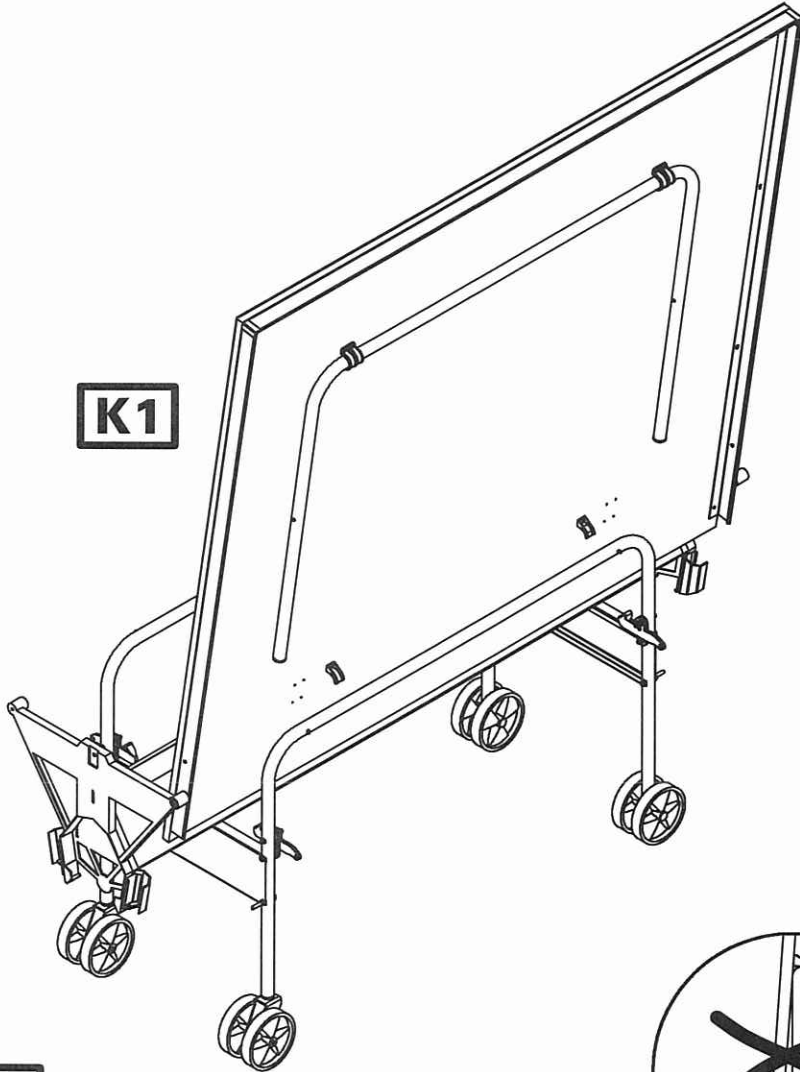

L

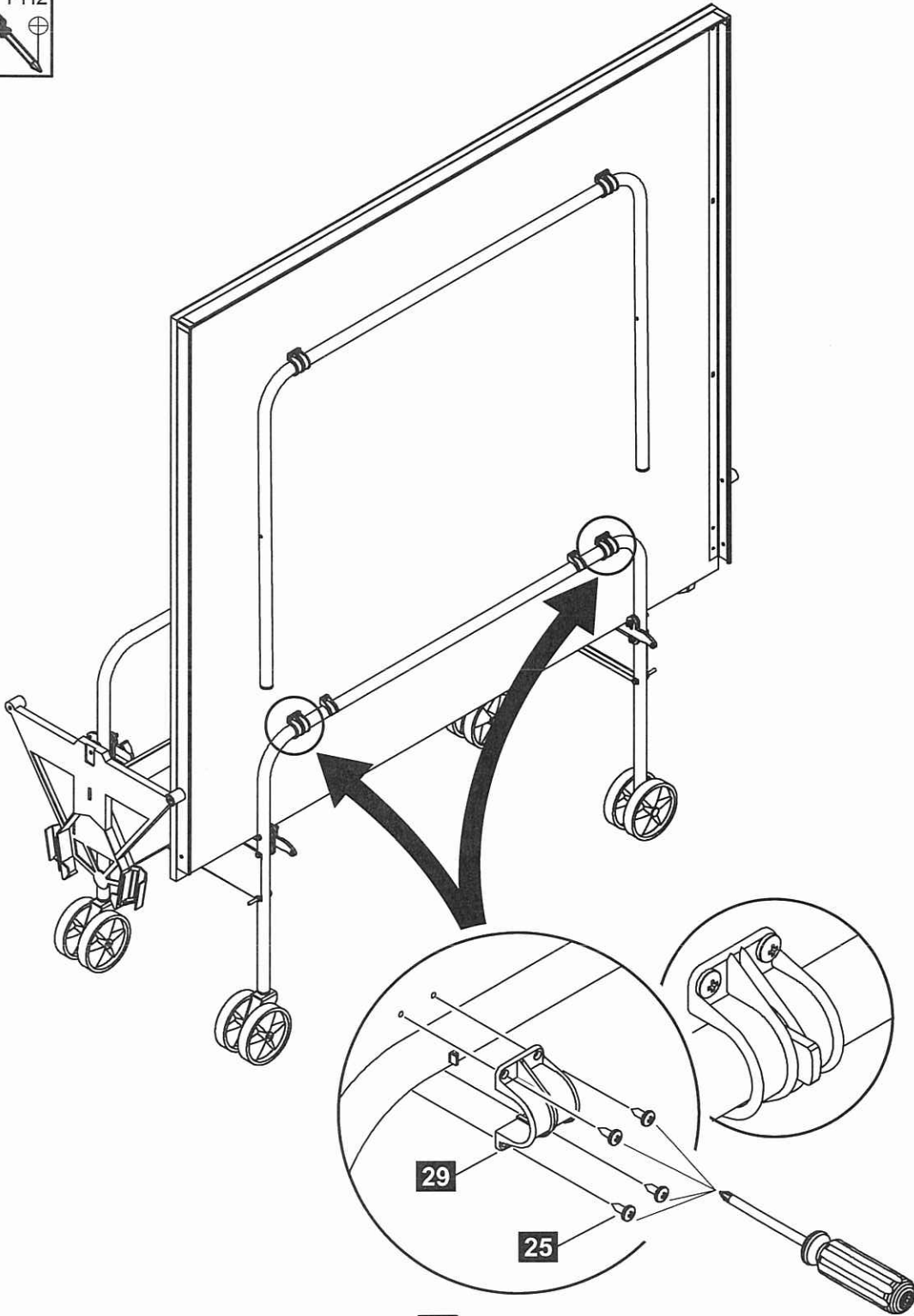



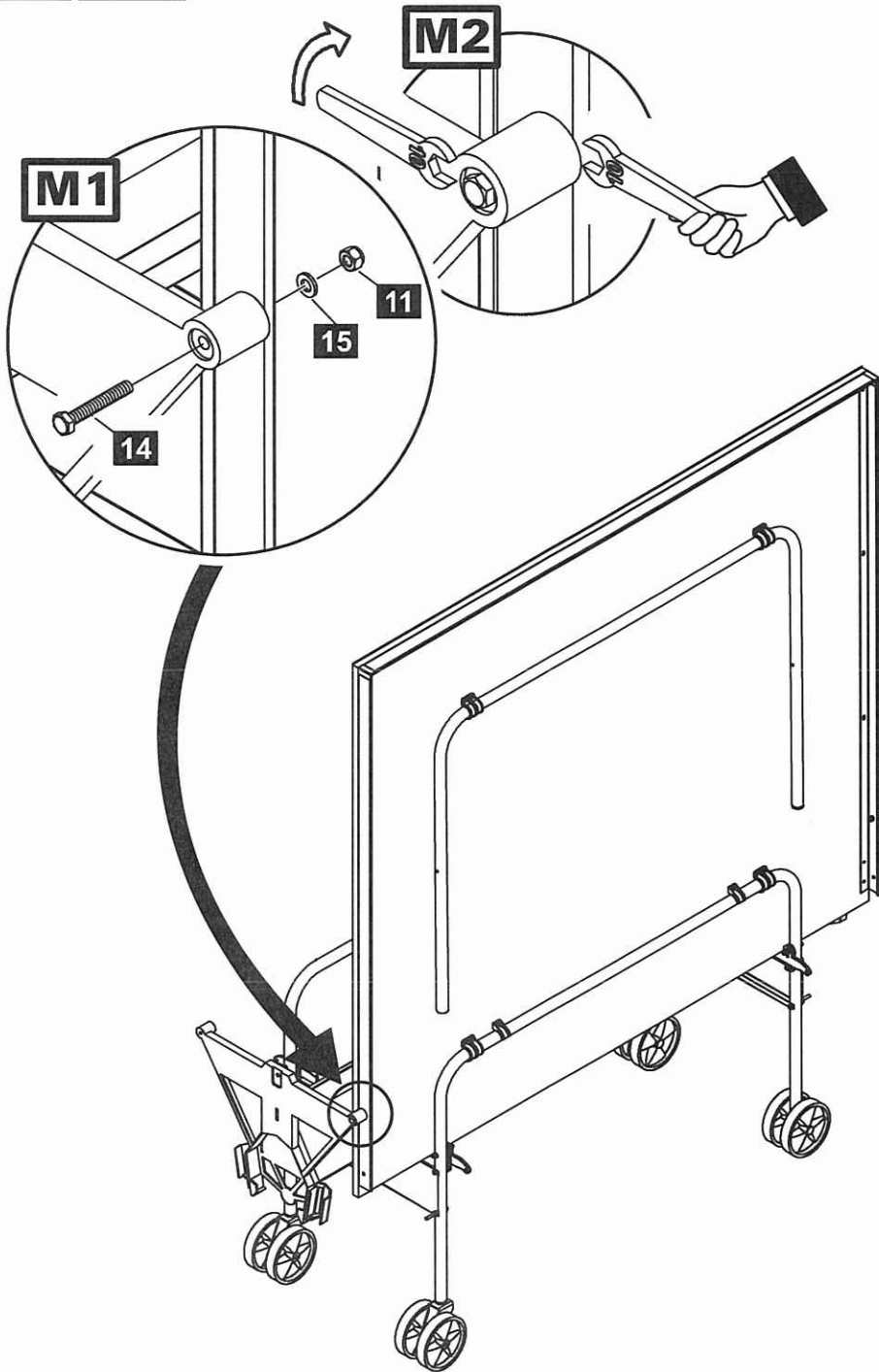
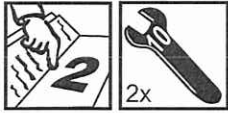

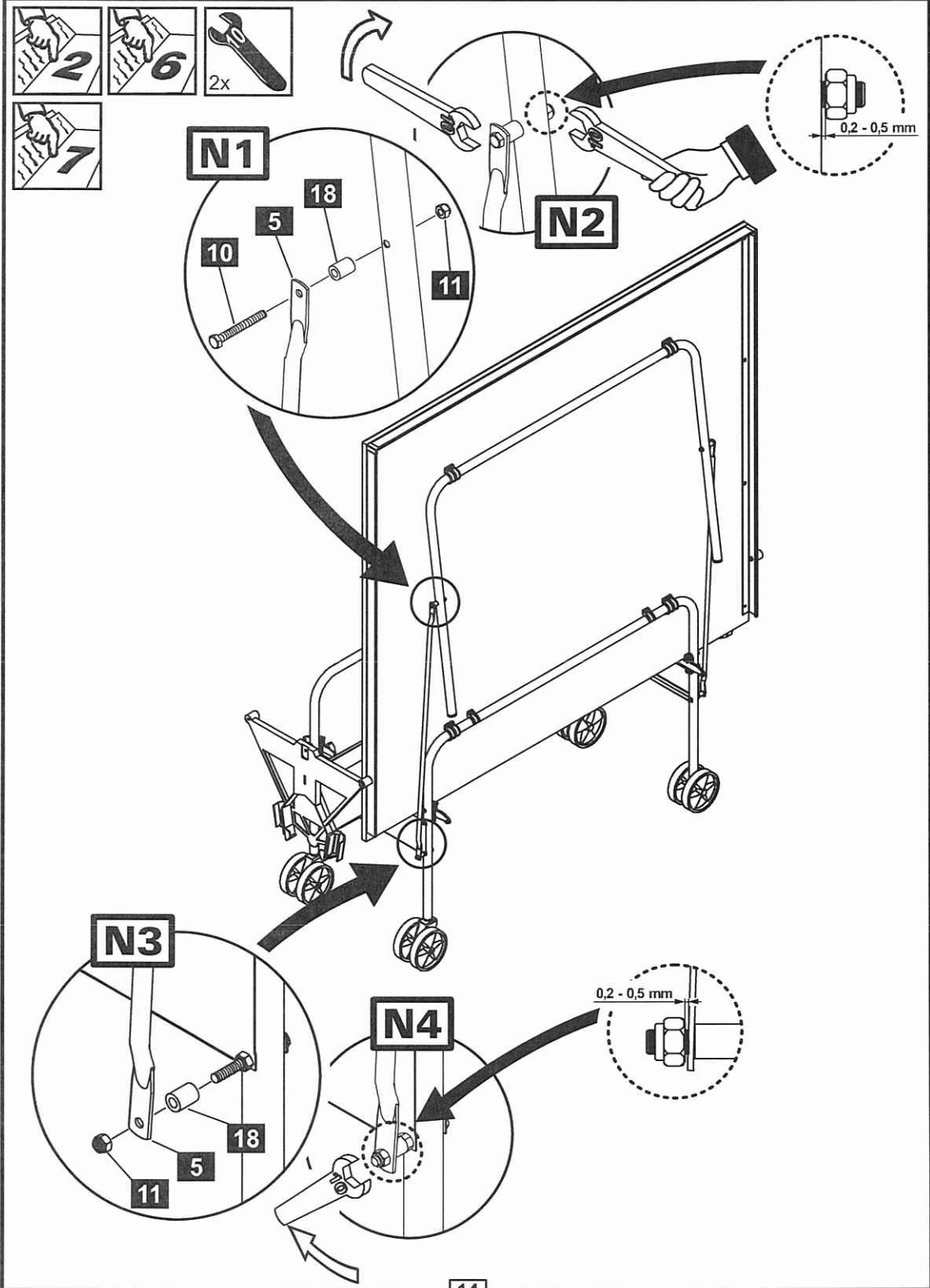

M 2x









N









D**Textmarken für die Montage**

-  • Muttern bei Sicherungselement **17** nicht zu fest anziehen, damit sich das rote Teil leicht bewegt.
-  • Mutter **11** nicht zu fest anziehen, damit sich der Tisch noch leicht auf- und zusammenklappen lässt.
-  • Gehen Sie zurück zu Schritt "A" und montieren Sie die 2. Plattenhälfte.
-  • Gehen Sie zurück zu Schritt "E" und montieren Sie die 2. Plattenhälfte.
-  • Gehen Sie zurück zu Schritt "G" und montieren Sie die 2. Plattenhälfte.
-  • Gehen Sie zurück zu Schritt "J" und montieren Sie die 2. Plattenhälfte.
-  • Führen Sie nach der Montage eine Funktionsprüfung gemäß der Bedienungsanleitung durch und entfernen Sie, falls notwendig, vorsichtig die Schutzfolie von der Spieloberfläche.







GB**Text marks for the assembly**

-  • Do not over tighten the nuts of the safety unit **17** so that the red part can still move easily.
-  • Please do not over tighten the nut **11** so that the tt-table can still be folded and unfolded easily.
-  • Go back to step "A" and assemble the second table top.
-  • Go back to step "E" and assemble the second table top.
-  • Go back to step "G" and assemble the second table top.
-  • Go back to step "J" and assemble the second table top.
-  • Please check all the working parts of the table in accordance with the Instructions for use (p. 17) after you have completed assembly. If applicable please take care when removing the coating from the playing surface.







F**Symboles**

-  • Ne pas trop visser les écrous du dispositif de sécurité **17**, afin que la partie rouge puisse bouger facilement.
-  • Veuillez ne pas visser trop fort l'écrou **11**, afin que la table de ping-pong puisse être ouverte et repliée aisément.
-  • Retournez à l'étape "A" et montez le second plateau.
-  • Retournez à l'étape "E" et montez le second plateau.
-  • Retournez à l'étape "G" et montez le second plateau.
-  • Retournez à l'étape "J" et montez le second plateau.
-  • Veuillez, après le montage, vérifier le bon fonctionnement de la table de ping-pong, conformément aux instructions d'utilisation, et enlever avec précaution, s'il y en a un, le film protecteur de la surface de jeu.







NL**Tekst aanduiding voor de montage**

-  • De moeren van zekerings(veiligheids)element **17**, niet te vast draaien, zodat het rode onderdeel makkelijk beweegt.
-  • Moer **11** niet te vast aandraaien, zodat de tafel nog gemakkelijk in-en uitklapt.
-  • Gaat u terug naar stap "A" en monteert u de tweede bladhalf.
-  • Gaat u terug naar stap "E" en monteert u de tweede bladhalf.
-  • Gaat u terug naar stap "G" en monteert u de tweede bladhalf.
-  • Gaat u terug naar stap "J" en monteert u de tweede bladhalf.
-  • Gelieve na de montage een functioneringstest uit te voeren volgens de bedieningshandleiding en verwijdert u, indien noodzakelijk, voorzichtig de beschermfolie van het speelblad.







E**Pasos de montaje**

-  • No apretar por encima las tuercas de la unidad **17** de seguridad, ya que la parte roja puede permanecer moviéndose fácilmente.
-  • No apretes la tuerca **11**, ya que la mesa puede permanecer plegada, y desplegarse fácilmente.
-  • Vuelve al paso "A", y ensambla la segunda parte de la mesa.
-  • Vuelve al paso "E", y ensambla la segunda parte de la mesa.
-  • Vuelve al paso "G", y ensambla la segunda parte de la mesa.
-  • Vuelve al paso "J", y ensambla la segunda parte de la mesa.
-  • Por favor revise todas las funciones de acuerdo con las instrucciones de montaje, después de haber montado le mesa. Quite cuidadosamente la capa de protección de la parte superior si es necesario.







CZ**Textové značky pro sestavení**

-  • Neutahujte příliš matice pojistné části **17**; červená část se musí lehce pohybovat.
-  • Prosim neutahujte příliš matici **11**; pinpongový stůl by měl být snadno složitelný a rozložitelný
-  • Vrat'te se ke kroku "A" a sestavte druhou vrchní část stolu.
-  • Vrat'te se ke kroku "E" a sestavte druhou vrchní část stolu.
-  • Vrat'te se ke kroku "G" a sestavte druhou vrchní část stolu.
-  • Vrat'te se ke kroku "J" a sestavte druhou vrchní část stolu.
-  • Po montáži proveďte zkoušku funkčnosti a odstraňte, když je to nutné, opatrně ochrannu fólii z vrchní desky pinpongového stolu.









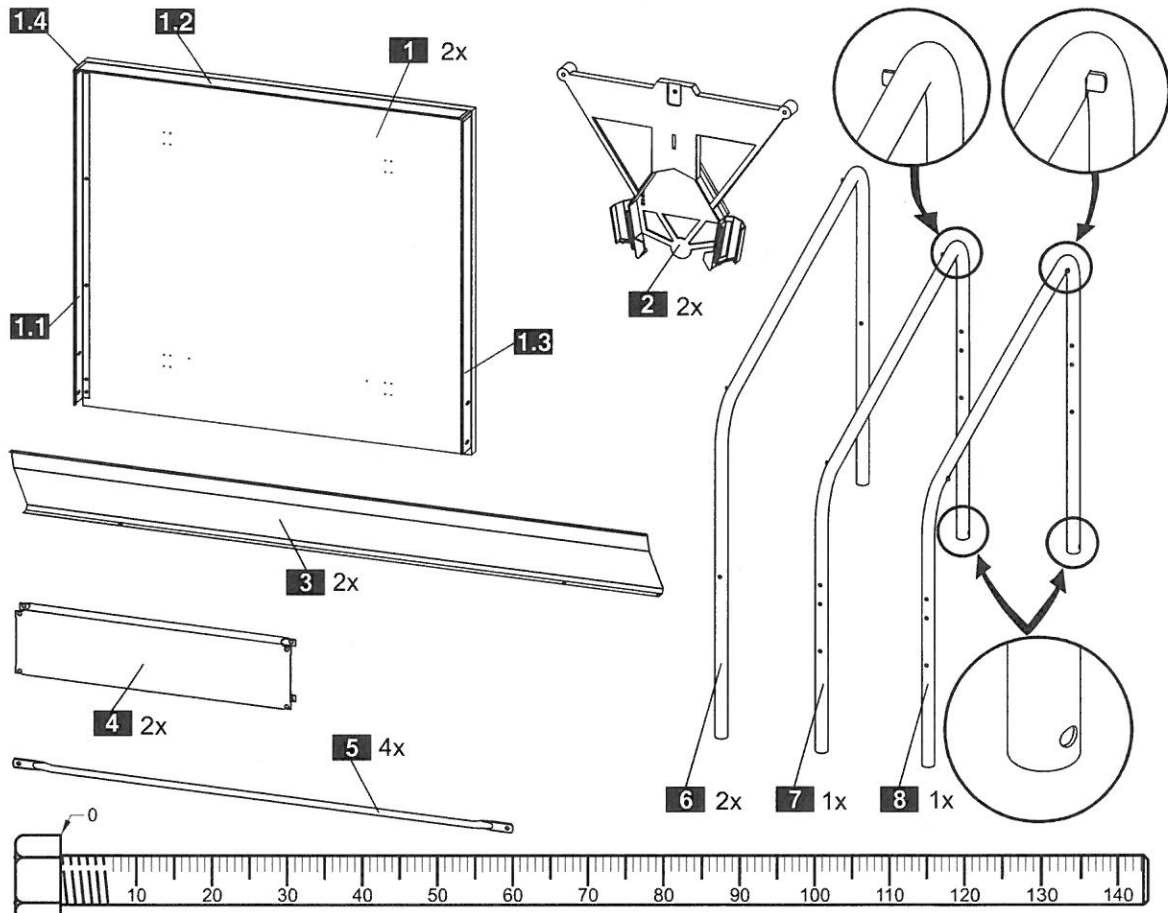

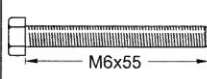
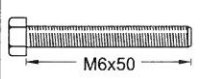

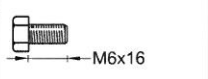



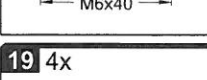

PL**Znak odsyłający w instrukcji montażu**

-  • Nie przykręcaj za mocno śrub elementu blokady oznaczonego numerem **17**, po to, aby blokada w kolorze czerwonym mogła się łatwo przesuwać.
-  • **11** aby swobodnie rozkładać i składać stół nie zaciskaj zbyt mocno śruby.
-  • Wróć do etapu "A" i zamontuj drugi blat stołu.
-  • Wróć do etapu "E" i zamontuj drugi blat stołu.
-  • Wróć do etapu "G" i zamontuj drugi blat stołu.
-  • Wróć do etapu "J" i zamontuj drugi blat stołu.
-  • Po złożeniu stołu, sprawdź jego funkcje zgodnie z instrukcją montażu. Usuń przekładkę.

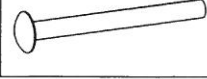
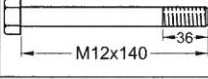
H**A szereléssel kapcsolatos szöveges jelzések**

-  • A **17** biztosító elem anyáit ne húzzuk meg túl erősen, hogy a piros elemet könnyen mozgatni lehessen.
-  • A **11** anyáit ne húzzuk meg túl szorosan, hogy az asztal könnyen föl lehessen állítani és össze lehessen hajtani.
-  • Térjünk vissza a "A" művelethez, és szereljük fel a 2. fél asztallapot.
-  • Térjünk vissza a "E" művelethez, és szereljük fel a 2. fél asztallapot.
-  • Térjünk vissza a "G" művelethez, és szereljük fel a 2. fél asztallapot.
-  • Térjünk vissza a "J" művelethez, és szereljük fel a 2. fél asztallapot.
-  • A szerelés befejezését követően ellenőrizzük a működést a kezelési útmutatóban előírtaknak megfelelően, azután amennyiben szükséges távolítsuk el a védőfóliát a játszó-felületről.



9 4x  M6x55	10 8x  M6x50	11 20x  M6	12 4x  M6x16	13 8x  M6
14 8x  M6x40	15 16x  Ø12 1.6	16 4x 	17 4x 	18 8x  Ø12 1.6
19 4x 	20 2x  M12x140 36	21 2x 	22 8x 	23 4x 
24 1x  Ø4,8x9,5	25 36x  Ø4,0x15	26 6x  Ø5x25	27 2x 	28 4x 
29 8x 	30 4x 			

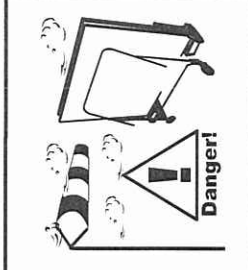
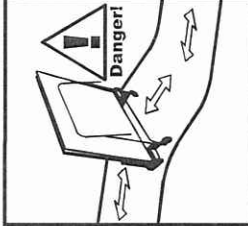
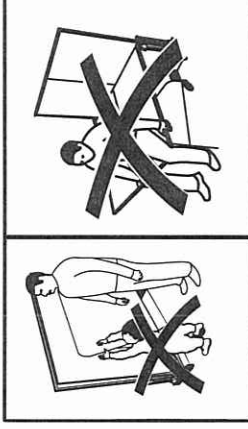
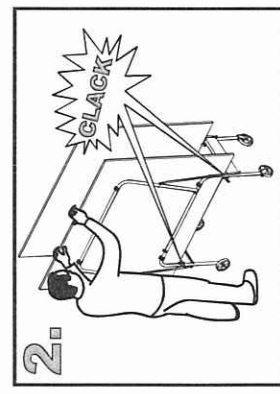
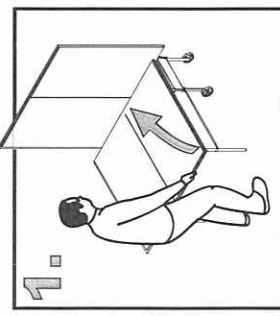
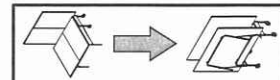
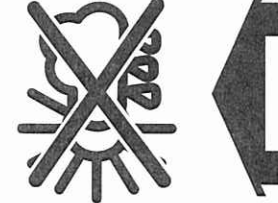
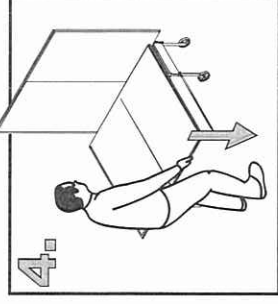
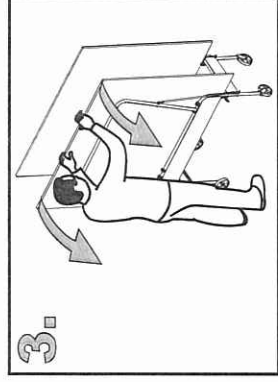
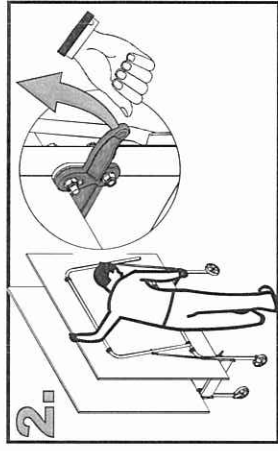
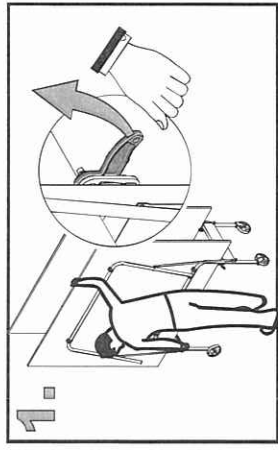
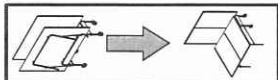

D Azul: Gidur f'indoor unibach f'igiem L'esan der Verriegelung! SPELGERATI Kroder nicht unbeaufsichtigt lassen. Kippgefahr!	GB Caution: Do not touch unintended opening of the locking devices. Do not touch when unpowered! Danger of tipping over when windy weather.	F Attention: Ne pas toucher d'éléments non destinés à cet usage. CE NEST PAS UN COULET! Ne pas toucher sans surveillance en cas de vent.	NL LET OP: Gevoelge voering van de veiligheids- inrichtingen! GEEF SPELGERATI Laten geen kinden zonder toezicht bij de tafel. Gevoel van omvallen bij windig weer!	E Cuidado: No tocar el mecanismo de abertura de las indicaciones de la No DEJAR niños sin vigilar, ya que hay riesgo de golpes con tiempo ventoso.	CZ Pozor! Ne dotýkat samotného uvolňovacího mechanismu! TOU NENÍ HRÁČKA! Nehrajte převrátilku ve větrném počasí!	PL Uwaga! Wystrzegaj się ręk zamykającego urządzenia zamykającego blokadę! nie dotykać! Dzieci nie mogą nie nadzorować! W przypadku silnego wiatru urządzenie może przewrócić się!	H Figyelmeztetés! A zárszármaztató működését ne érintse személyesen! Gyermekek nem játszhatnak vele! A szél ellenőrzésénél szüneteljen!	AL Ushiti: Ekipazje ne dotikati mekhanizam otvaranja za vrijeme jakog vetrovanja!	BG Внимание: Не допирайте механизма за отваряне на блокирането! Не играйте с устройството! Децата не трябва да играят с него! При силен вятър устройството може да превърта!	DK Opmærksomhed: Dit er en lås, hvis afslutningen udføres uforsigtigt, kan DELSKAD LEDES! Børn skal være under oplysning! Ved stærkt blæsende vejr kan apparatet overdrejnings!	EST Ettevaatust! Oli kokkade juhustajki avõnetamist LAUD ei ole mõeldav! Laste mängimise ajal ei ole lubatud puudutada Tululõhe liina ummist tõttu!	FIN Varoitus: Älä kosketa lukun aukussa sijaitsevaa TAVAN OLE KÄRKÄÄ! Älä kosketa lukun aukussa Tululohon olemassa ollessa on vaara kastumista.	IS Varoitus: Heldu þess myndast ef fjarlægningu lögsa af sigli. Sér EKERT LEIÐFERM Fylgjubörn Gæfir fórn um kal! Hvarstöðin.	GR Προσοχή: Μην αγγίζετε τη μηχανή ανοίξης ΑΝ ΕΙΝΑΙ ΠΑΡΚΛΑΜ! Μην αγγίζετε επιχειρηματικό τμήμα Ζητήστε καθίσταται επιτηρηθεί.	TR Dikkat: Kilit mekanizmasını açarken elinize dokunmayın! ÇOCUKLARIN GİZLİ KISIMLARINA TOUMAYIN! Çocuklar mekanizmayı birbirine dokunmadan açamazlar! Rüzgar çok güçlüyse bulurmakadır.	UA Увага: Не торкайтесь механізму відкриття рич інструменту або пристрою! ДІТИ НЕ МОЖУТЬ ІГРАТИ! Не зачіпайте прилад без нагляду дитини У сильну бурю пристрій може перевернутися!	P Atención: Este sistema em caso de desastres puede ser utilizado para E.U. BINGIYOR! Vijle sempre as indicações de segurança! Não toque nos buzios sem supervisão! Em condições de vento este sistema pode inverter-se!	BIH Opasnost: Ovaj sistem u slučaju neprijateljstva može se koristiti kao U slučaju jakog vjetra ovaj sistem može prevrnuti!
------------------------------------------------------------------------------------------------------------------------------------------------------------	----------------------------------------------------------------------------------------------------------------------------------------------------------------------------	----------------------------------------------------------------------------------------------------------------------------------------------------------------------------	---------------------------------------------------------------------------------------------------------------------------------------------------------------------------------------------------------	--------------------------------------------------------------------------------------------------------------------------------------------------------------------------------------	-------------------------------------------------------------------------------------------------------------------------------------------------------	-------------------------------------------------------------------------------------------------------------------------------------------------------------------------------------------------------------------------	------------------------------------------------------------------------------------------------------------------------------------------------------------------------	---------------------------------------------------------------------------------------------------------	-------------------------------------------------------------------------------------------------------------------------------------------------------------------------------------------------------------------------	-------------------------------------------------------------------------------------------------------------------------------------------------------------------------------------------------------------------------	------------------------------------------------------------------------------------------------------------------------------------------------------------------------------------------	--------------------------------------------------------------------------------------------------------------------------------------------------------------------------------------	-------------------------------------------------------------------------------------------------------------------------------------------------------------	--------------------------------------------------------------------------------------------------------------------------------------------------------------	----------------------------------------------------------------------------------------------------------------------------------------------------------------------------------------------------------------------------------	-------------------------------------------------------------------------------------------------------------------------------------------------------------------------------------------------------------------------------	---------------------------------------------------------------------------------------------------------------------------------------------------------------------------------------------------------------------------------------------------------------------	-------------------------------------------------------------------------------------------------------------------------------------------------------------