



JUKEBOX BOWL-O-RAMA® MANUAL

BANDAI NAMCO



Important

**Read PRECAUTIONS and INSTALLATION
Sections before operating game**

FCC Notice

Note: This equipment has been tested and found to comply with the limits for a Class A digital device, pursuant to Part 15 of the FCC Rules. These limits are designed to provide reasonable protection against harmful interference when the equipment is operating in a commercial environment. This equipment uses, and can radiate radio frequency energy and, if not installed and used in accordance with the instruction manual, may cause harmful interference to radio communications. Operation of this equipment in a residential area is likely to cause harmful interference in which case the user will be required to correct the interference at his own expense.

Table of Contents

TABLE OF CONTENTS 3

INTRODUCTION..... 5

CONTROLS..... 5

CONTENTS 7

SAFETY PRECAUTIONS 8

 INSTALLATION LOCATION 8

 HANDLING..... 8

MENUS..... 9

 ADJUSTMENT MENUS.....10

Audio Adjustments Menu 11

Game Adjustments Menu..... 12

Network Adjustments Menu..... 13

 DIAGNOSTIC MENUS.....14

Display Test Patterns Menu..... 15

Audio Tests Menu.....15

Switch Tests Menu.....16

Lamp Tests Menu..... 16

 RESETS..... 17

 SYSTEM INFO.....18

 SOFTWARE UPDATE.....18

TROUBLESHOOTING..... 19

 NO POWER (EVERYTHING IS OFF).....19

 GAME POWERS ON BUT DOES NOT START UP 19

 NO VIDEO ON SCREEN 19

 CONTROL PANEL SWITCHES DO NOT WORK 19

 TRACKBALL DOES NOT WORK OR WORKS ERRATICALLY..... 19

 BUTTONS DO NOT LIGHT.....20

 DEVICE NOT ON PHONE BLUETOOTH LIST.....20

Operator's Manual

GAME PLAY	21
THE BUTTONS	21
HOW TO BOWL, HOW TO BOWL BETTER	21
<i>Call Pins By Number</i>	21
<i>Choosing a Ball</i>	21
<i>Heading for the Pocket</i>	22
<i>Markings on the Lane</i>	22
<i>Throwing a Straight Ball</i>	22
<i>Throwing a Hook Ball</i>	22
ABOUT THE GAMES	23
REGULATION TEN PIN BOWLING	23
<i>The Rules and Scoring</i>	23
TRICK SHOT	23
<i>The Rules and Scoring</i>	23
TEN PIN POKER	23
<i>The Rules and Scoring</i>	24
BOWL21 BOWLING	24
<i>The Rules and Scoring</i>	24
FLASH-O-MATIC	25
PARTS LIST	26
MAIN BOARD IMAGE	27
WIRING DIAGRAM	28

Specifications

88 ~ 132VAC / 176 ~ 264VAC selected by switch
47 ~ 63Hz
3A/115VAC 2A/230VAC

Shipping Dimensions: 39"W x 30"D x 70"H
Install Dimensions: 28.5"W x 31"D x 64"H
Weight: 245 lbs

Introduction

Jukebox Bowl O Rama® is a multi-player video game featuring trackball-controlled on-screen bowling, and 4 large push buttons that perform the following functions:

Controls

1. **START / SELECT ("Play" Icon):** This button starts the game, resets the ball on the approach before taking a shot, selects shots in Trick Shot and selects cards in Ten Pin Poker.
2. **INSTANT REPLAY / LAST SONG (Camera Icon):** This button plays a slow motion replay of the last shot. Press the button during the replay to change the camera angle. During jukebox mode this button goes back a song.
3. **SCORESHEET / SONG DISPLAY (Score Box Icon):** Press and hold this button to bring up the score sheet during the game. During jukebox mode this button displays the song information.
4. **JUKEBOX / NEXT SONG (Musical Notes Icon):** This button is used to enter jukebox mode and while in Jukebox mode advance to the next song.

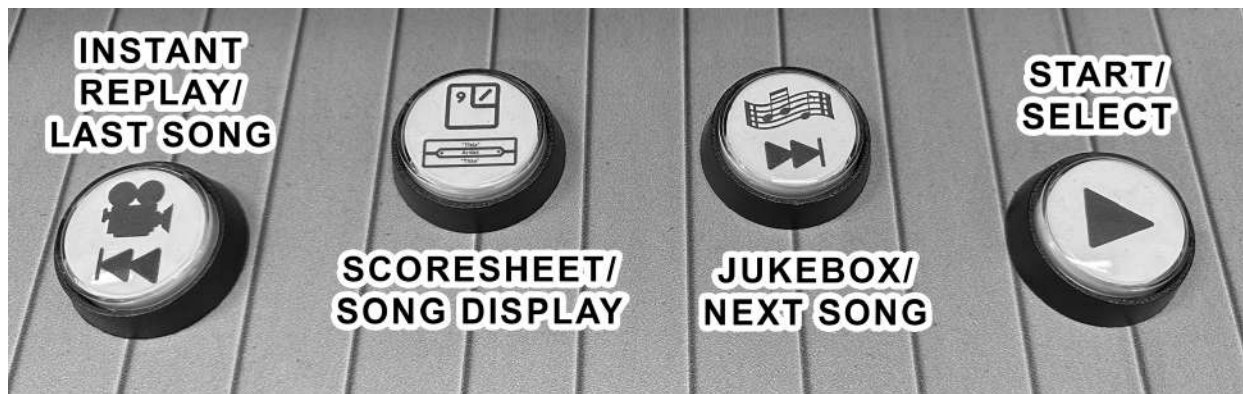

Controls (cont)

1. **ADJUSTMENT KNOB / BUTTON:** This controls game and jukebox volume as well as allows access to the game menus when pressed inwards.
2. **USB INPUT:** This is a standard USB connection which can be used to charge a phone, charge the microphone receiver or install software updates from USB if you do not have a WiFi connection.
3. **MICROPHONE INPUT:** This is a standard microphone input for you to plug in the INCLUDED wireless microphone's mic receiver (See pg 7) or your own wired microphone (NOT INCLUDED).

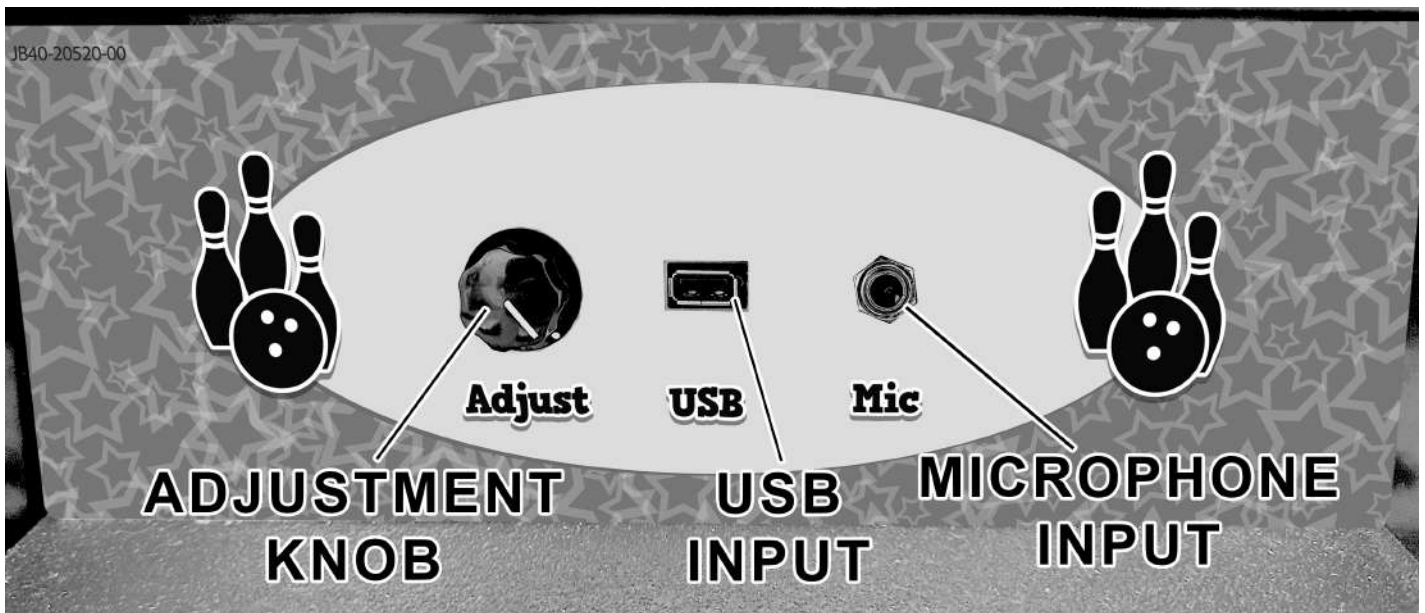

Contents

INCLUDED:

- (1) JUKEBOX BOWL-O-RAMA GAME CABINET
- (1) JUKEBOX BOWL-O-RAMA MANUAL
- (1) POWER CABLE
- (1) MICROPHONE BOX W/ACCESSORIES (SEE BELOW)



Safety Precautions

Be sure to read these instructions completely to ensure safety.

WARNING

This product is only to be installed by qualified personnel. Persons not already familiar with the hazardous high voltage electronics present inside coin operated video games should not attempt to install this product.

WARNING

To protect yourself and other people from an electric shock, accident, and injury and to prevent damage to the electrical circuitry of the machine, always turn off the power switch and unplug the game before accessing game internals.

Installation Location



This game is designed for indoor use only.

It must not be installed outdoors. The following conditions must be avoided:

1. Direct exposure to sunlight, extreme high humidity, direct water contact, dust, high heat or extreme cold.
2. Vibration. The game must be installed on a level surface

Do not install in an area such that the game would present an obstacle in case of an emergency (i.e., near fire equipment or emergency exists).

Handling

1. Before operating the game, make sure that the main AC power hookup includes a safety ground. This will help to ensure safe operation. Measure the AC power line voltage. Verify that the voltage source is between 110 and 125 VAC.
2. Before replacing any parts, turn the AC power OFF and unplug the game.
3. The game includes areas where 120 VAC is present. Take care at all times to avoid electrical shock whenever inspecting or adjusting the game.

Menus



To enter the **test mode**, access the **MAIN MENU** and make game adjustments follow the steps below:

1. Press inward and hold the volume adjustment knob until the **MAIN MENU** appears.
2. The highlighted item will appear in red. Other items appear white.
3. To change which item is highlighted press the **REPLAY** button to move up or the **SCORE SHEET** button to move down, or simply roll the trackball.
4. Press the **START** button to select the highlighted item. After a period of inactivity test mode will automatically exit and return to gameplay.

Adjustments Menu

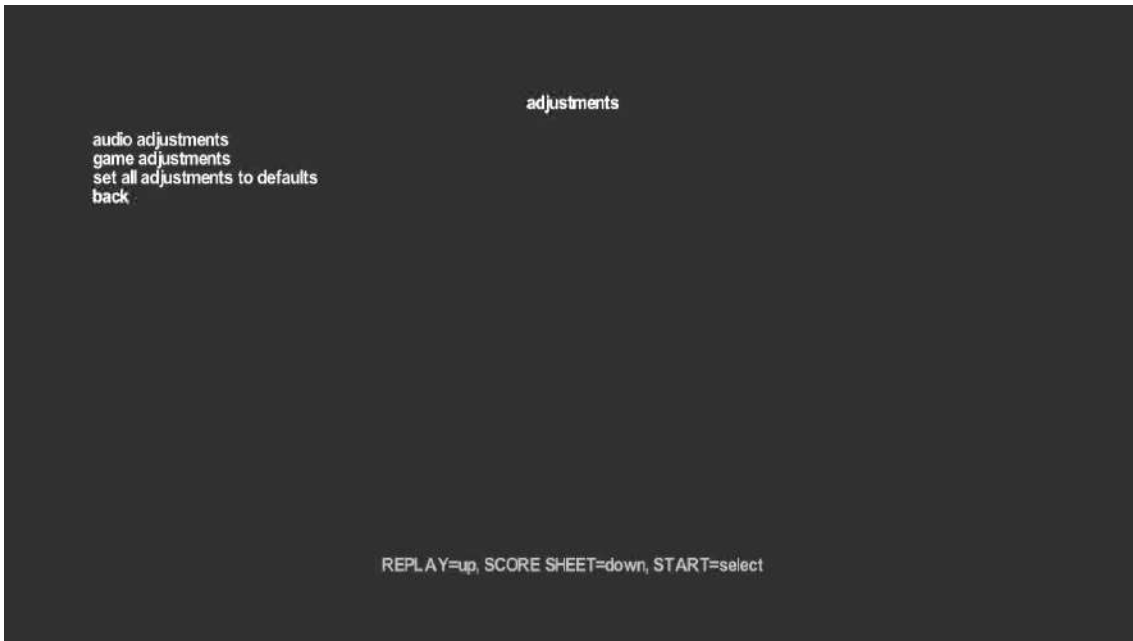

Adjustments permit the operator to set various parameters and behaviors about the machine. In general, to change an adjustment, first highlight it (in red), then press **START**.

The adjustment should turn green.

Press **REPLAY** and **SCORE SHEET** (or roll the trackball) to change the adjustment to the desired value. Press **START** to save the new setting.

The adjustment will return to red.

Audio Adjustments Menu

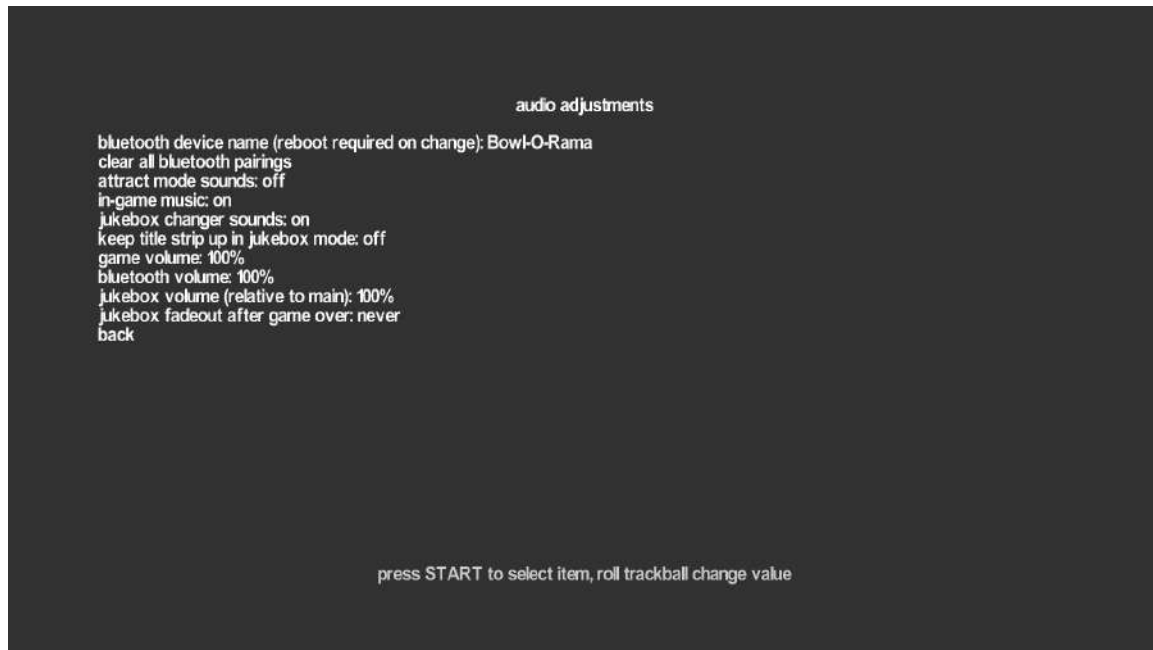

Bluetooth device name (reboot required on change): Bowl-O-Rama:

This will change the name of the bluetooth signal broadcasting from this device. Default bluetooth signal name is **Bowl-O-Rama**. You can get the serial number of your game if your game displays "**Bowl-O-Rama XXXXX**" under this setting.

Clear all bluetooth pairings: This will clear any devices that are currently paired or connected to the machine via bluetooth.

Attract mode sounds: off: This turns the attract mode sounds on and off.

In-game music: on: This turns the in-game music on and off. If a device is connected via bluetooth the in-game music will be turned off automatically.

Jukebox changer sounds: on: This turns the jukebox changer sounds on and off.

Keep title strip up in jukebox mode: off: this will allow the title strip displaying song information to stay up and visible during jukebox mode.

Game Volume: 100%: this setting adjusts the volume of the game.

Bluetooth Volume: 100%: this setting adjusts the bluetooth volume.

Jukebox volume (relative to main):100%: this adjusts the in-game music volume.

Jukebox fadeout after game over: never: this setting adjusts if the in-game music performs a fadeout after a game over.

Back: Return to previous screen.

Game Adjustments Menu



Display backlight brightness: 75% This will change the brightness of the screen on the game. Default value is shown.

Difficulty: Normal: This setting adjusts the difficulty of the gameplay between **Easy, Normal and Difficult.**

Times same name may appear in high scores: 1 This setting adjusts the amount of times the same name can appear in the high score menu.

Idle timeout: 90 sec: This sets the length of time for the game's idle timeout timer.

Extra instant replay restarts:4 : This sets the amount of extra instant replay restarts for gameplay.

Bowl21:Enabled: This will enable or disable the Bowl21 game mode.

10 Pin Poker: Enabled: This will enable or disable the 10 Pin Poker game mode.

Shots which give cards in 10 Pin Poker: strikes and spares: This adjusts the shots that give cards in the 10 Pin Poker game mode.

Network Settings Menu



Select WiFi network: This will open the list of nearby WiFi networks that the machine can connect to and allow you to start the connection process.

Delete WiFi network: This will clear the currently connected WIFI network from the game.

Delete ALL WiFi networks: This will clear ALL saved wifi networks on the game.

Pre-Service and Diagnostic Test check Menu

Once the game has started up the first time perform a pre-service check to ensure everything is working correctly. If any checks fail see “Troubleshooting” on page 25.

1. The display should be bright and clear and the game should be running in attract mode.
2. Press the adjust knob inwards and hold for 5 seconds to enter the test menus
3. Roll the trackball or press the **REPLAY** and **SCORESHEET** buttons to highlight “diagnostics”. Press **START** to go to the diagnostics menu.
4. Perform the audio, switch, and lamp tests to ensure that all inputs and outputs are operating correctly.
5. Exit the test mode. Either maneuver back through the menus or simply wait for test mode to time out and exit on its own.

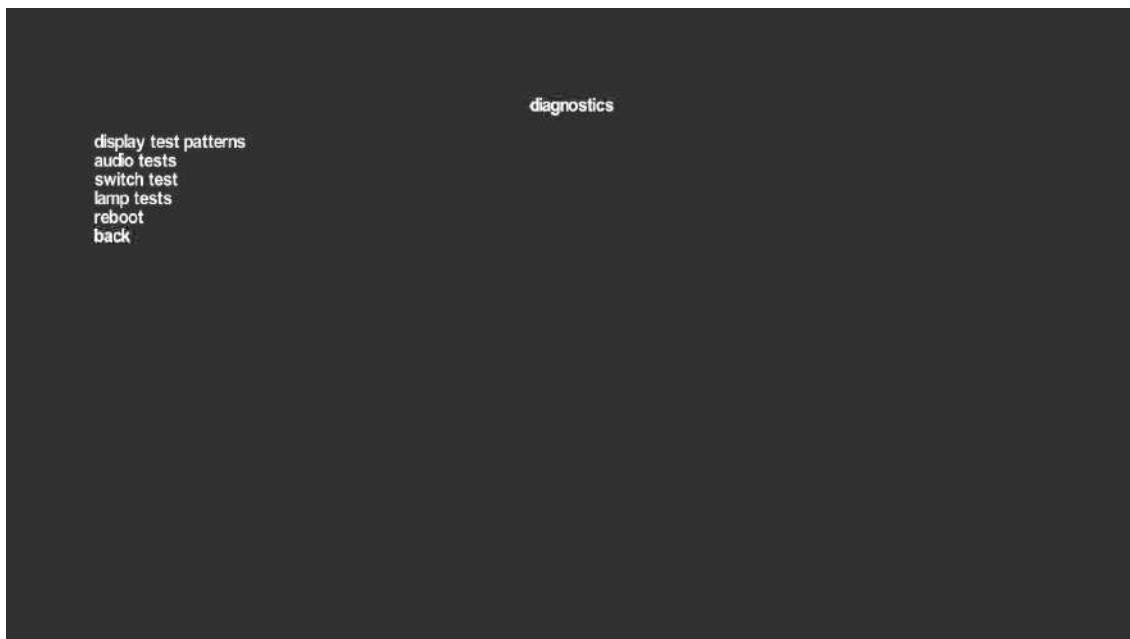

Display Test Patterns Menu

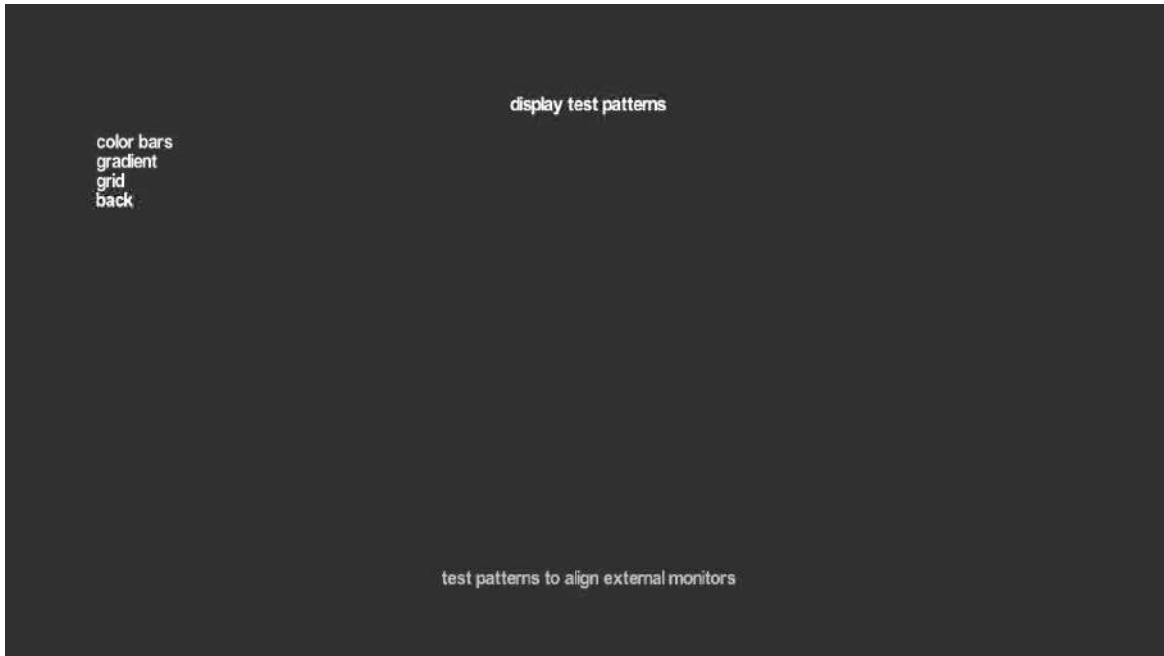

These menus will display various images (**Display Test Pattern Menu pg.14**), play audio tones tests (**Audio Tests Menu pg.14**), allow you to perform switch tests (**Switch Test Menu pg.15**) and test the LED lamps in the (**Lamp Tests Menu pg.15**) to ensure proper performance.

Audio Tests Menu



Switch Test Menu

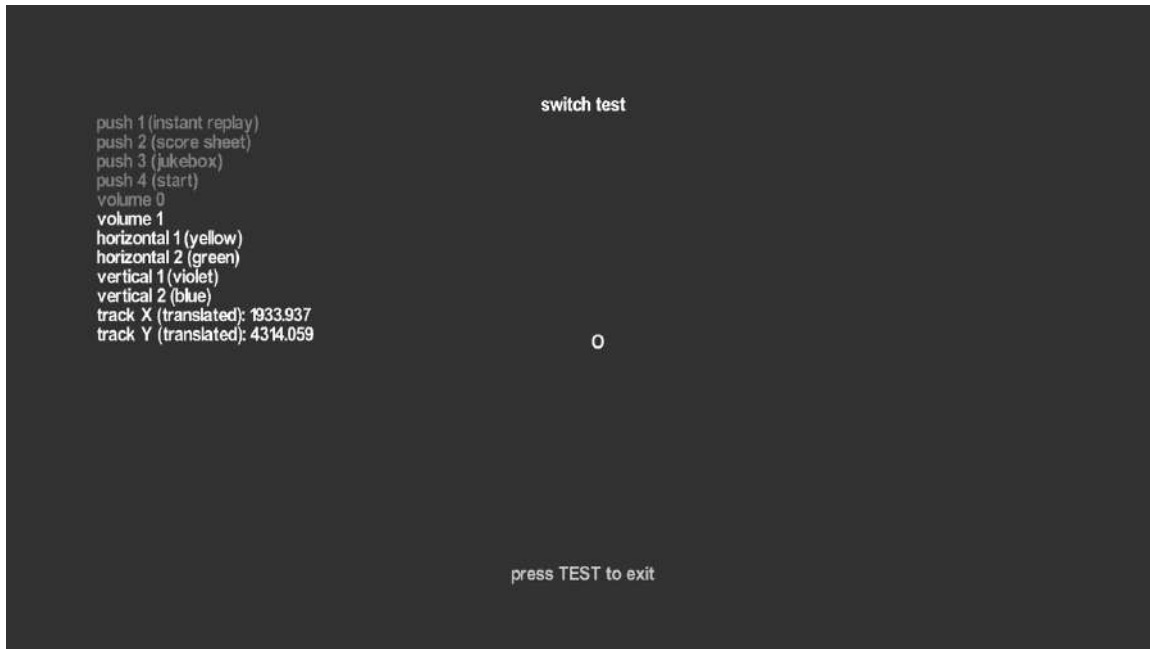

To assist in the diagnosis of trackball problems each of the trackball inputs are listed. Also, a count is shown for X and Y as the ball is spun.

Lamp Test Menu

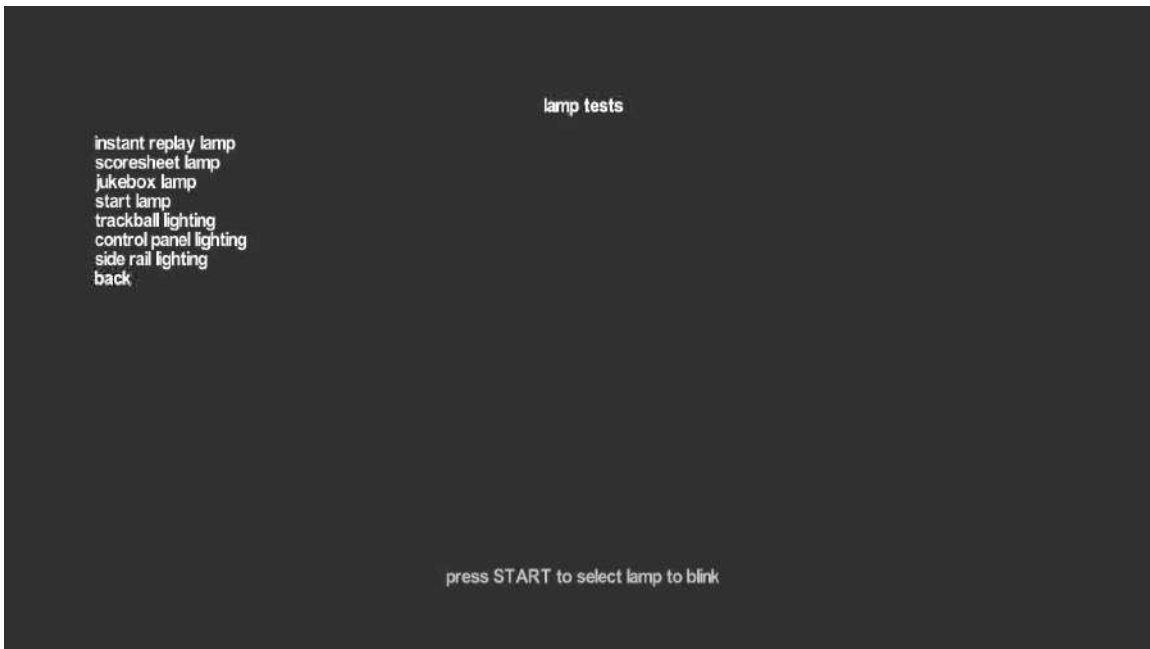

Resets Menu

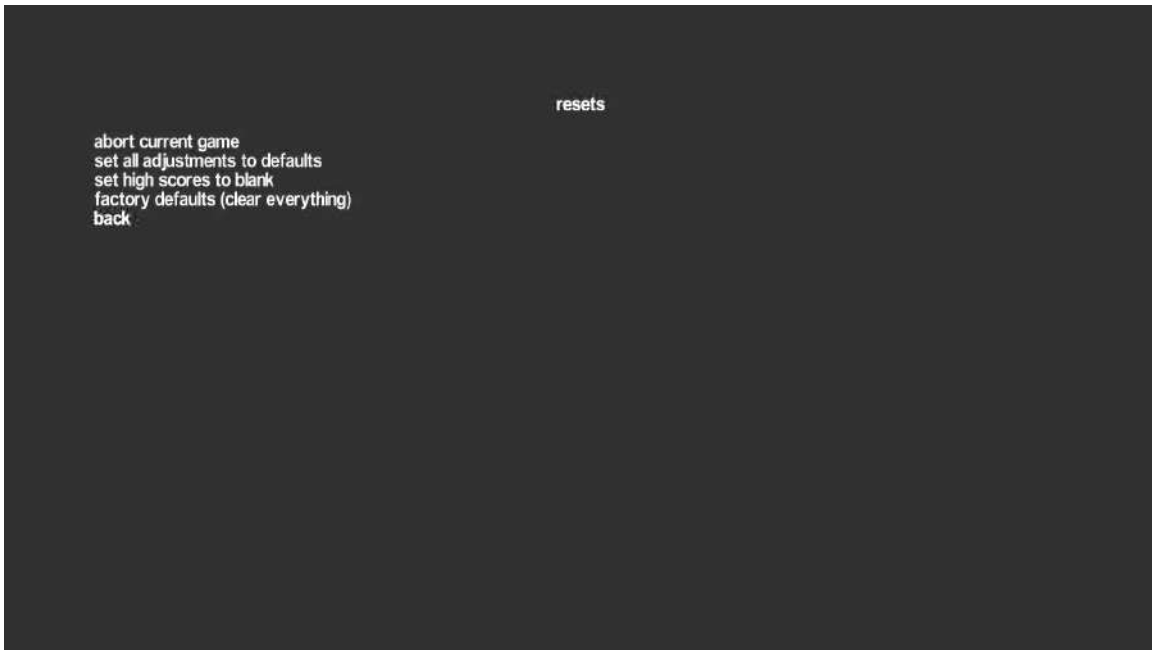

Abort current game: This will end the current game that is in progress on the machine and return you to the games main menu.

Set all adjustments to defaults: This will clear all menu settings made and will reset the machine to the factory default settings. **(please note that this DOES NOT roll back already existing and performed software updates.)**

Set high scores to blank: This will reset all existing high scores on the machine to blank values.

Factory defaults (clear everything): This will completely clear the machine of all settings and high scores and reset the machine to factory defaults.

System Info Menu

The **SYSTEM INFO MENU** will display all current specifications about the machine including the software version that is currently installed.

Software Update Menu

The **SOFTWARE UPDATE MENU** will allow you to update the game software via USB from the connection on the front of the machine or via a WIFI connection from the **NETWORK SETTINGS MENU (see pg. 14)** Once the machine is connected to a WIFI network this menu will allow you to check for any software updates utilizing your WIFI connection. The machine will show you if an update is available or not and the on screen instructions will walk you through the process of upgrading your machines software should any software updates become available.

Troubleshooting

For each of the symptoms below a list of items to check are provided. Go through the list in order to find the most likely cause of the problem.

No Power (everything is off)

1. Check that the power cord is plugged in and the game is turned on.
2. Ensure that the service outlet which the game is plugged into is operational.
3. Check that the power supply is plugged into the board securely.
4. Check that the power switch switch on the back of the game is turned on.

Game Powers On But Does Not Start Up

Listen for the pin crash sound on start up. This plays right as the game finishes its start up sequence and enters attract mode. If this plays but nothing appears on the screen, see "No Video On Screen", below.

No Video On Screen

If the game does not start up (no pin crash sound is heard) check that all connections to the board are correct and secure. Do this with the power off, then turn the power back on.

Control Panel Switches Do Not Work

Ensure that the control panel harness is plugged into the board.

Trackball Does Not Work or Works Erratically

1. Enter test mode and go to the switch test screen under "diagnostics".
2. Each of the four signals from the trackball are displayed along with their wire colors for easy identification. Roll the trackball. All four should toggle on and off.
3. If one or more do not toggle, check to make sure the trackball is properly plugged in and that none of the wires are broken or pulled out of one of the connectors.
4. If the wiring looks correct, the problem is probably with one of the opto encoders on the trackball. If none toggle the trackball is probably either unplugged or is not receiving power.

Troubleshooting (Cont)

Buttons Do Not Light

1. Enter test mode and go to the lamp test under "diagnostics"
2. Check each lamp. Each test should make its lamp blink.
3. If none of the lamps work, check that the control panel harness is undamaged and is properly plugged in to the board.
4. If one or more lamps do not work, try replacing the bulbs. The switches are snapped into their bezels from underneath the control panel. The bezels do not need to be removed.
5. Twist and pull the switch assembly out from underneath the control panel. Replace the bulb and perform the lamp test again. If the lamp is functioning snap the switch assembly back up into the bezel.
6. If replacing the lamp does not correct the problem the trouble may lie in the output driver on the board

You do not see the device on your Phones Bluetooth

1. Enter test mode and go to the audio adjustments under "diagnostics"
2. Check the bluetooth network name and ensure you are connecting to the correct device.
3. If you still cannot see the device navigate to "Clear all bluetooth pairings" under the same audio adjustments menu and this should clear any existing pairings to allow you to try to connect again.

Game Play

The Buttons

1. **START/SELECT** (Play Icon): This button starts the game, resets the ball on the approach before taking a shot, selects shots in Trick Shot and selects cards in Ten Pin Poker.
2. **INSTANT REPLAY** (Camera Icon): This button plays a slow motion replay of the last shot. Press the button during the replay to change the camera angle.
3. **SCORESHEET** (Score Box Icon): Press and hold this button to bring up the score sheet during the game.
4. **JUKEBOX** (Musical Notes Icon): This button is used to change the song on the jukebox. Press it repeatedly to "break" the jukebox and shut it off. Press it again to start it back up. The Jukebox will not "break" if the music is provided via bluetooth

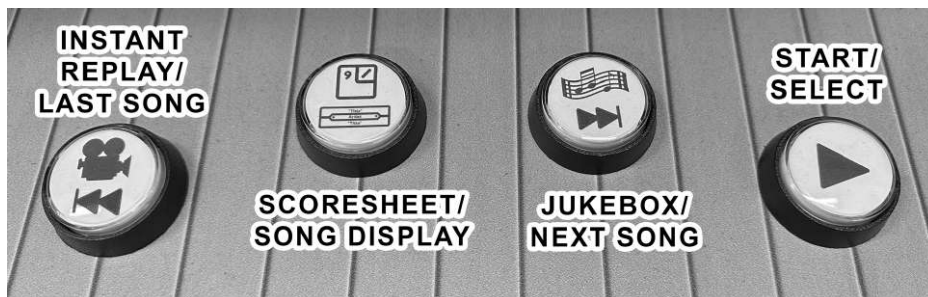

How to Bowl, How to Bowl Better

Call Pins By Number

The pins are called out by number like this:



Always call pins in order. The Lily, for instance, is called out as the 5-7-10, never the 7-5-10. The 1-pin is called the head pin, while the 5-pin is sometimes called the king pin.

The pin indicator at the upper right corner of the screen during the game shows which pins are standing. This can be helpful when one pin is hiding behind another (a "sleeper"). If you don't hit it just right the front pin will deflect one way while the ball deflects the other, leaving the sleeper standing.

Heading for the Pocket

The best chance for a strike comes from hitting the pocket. The pocket is the space between the head pin and the 3-pin for right-handed bowlers or the head pin and the 2-pin for left-handed bowlers. The greater the angle of entry into the pocket, the better the chances are for a strike. This is why experienced bowlers usually throw a hook ball.

Markings on the Lane

The dots and arrows on the lane are there to help you line up your shots. The dots right next to the foul line are roughly in line with the pins spotted on the pin deck. The large dot in the center is lined up with the head pin. You can follow the boards on the lane straight down from the large dot to the head pin. The boards are often numbered as you move away from the edges. Five boards from the left edge would be L5, while ten boards from the edge right would be R10.

The arrows part way down the lane allow for more advanced targeting. Rather than aiming for a pin, experienced bowlers will line up at a specific board on the approach and aim for an arrow. If the ball rolls over the arrow but doesn't end up where expected, the bowler will make an adjustment to the starting position on the approach or to the targeted arrow.

Throwing a Straight Ball

To throw a straight ball, line up your shot on the approach by rolling the ball left or right. To throw it just roll forward. The faster you roll the faster it goes, up to its maximum speed. A lighter ball will have a higher maximum velocity.

When throwing straight your chance of a strike is improved if you start off to one side and throw diagonally towards the pocket. It's a little trickier to aim when throwing diagonally across the lane but the results are worth the effort. Use the arrows for aiming.

Throwing a Hook Ball

Once you've mastered throwing the ball straight, the next step is to throw a hook. Throwing a hook requires adding spin to the ball. The lane is oiled so that it's slipperier towards the player and drier near the pin deck. If the ball is thrown with a diagonal spin, it will slide mostly straight on the slippery part of the lane then grab and turn in the direction of the spin when it reaches the drier part. This is how an experienced bowler causes the ball to hook.

To create the necessary spin to hook the ball, start by lining up on the approach by rolling the ball left or right. When you are in the right spot, start the ball spinning by pulling the trackball straight backwards. You'll see the ball spin and a ring of spinning stars (the Spindicator) will appear to help indicate the direction and speed of the spin. At this point the ball can no longer move left or right on the approach. Rolling the ball left or right will change the angle of the spin, pulling it back will increase the speed of the spin. To throw it, roll forward in the direction you want the ball to go. If you make a mistake while setting up your shot, press the START/SELECT button to cancel the spin. This will let you move the ball left or right on the approach again and start the shot over.

About the Games

Regulation Ten Pin Bowling

Regulation Ten Pin Bowling is just like what you play down at the lanes. You can choose to play a full game (ten frames), or a three-game series (three full games of ten frames each).

The Rules and Scoring

A game consists of ten frames. Each player gets two chances to knock down all ten pins on each frame. If all ten pins are knocked down on the first shot, the frame is marked as a strike and the second shot is not needed. If all pins are knocked down on the second shot the frame is marked as a spare. If less than ten pins are knocked down after two shots the frame is considered "open".

A strike scores ten points plus the pins knocked down on the next two shots. A spare scores ten points plus the pins knocked down on the next shot. An open frame scores the number of pins knocked down in that frame.

The tenth frame is treated special in that if the player gets a strike or a spare additional shots are required to finished the frame (two in the event of a strike, one in the event of a spare). This is because a strike scores ten plus the next two shots and a spare scores ten plus the next shot.

Trick Shot

In Trick Shot players choose from a variety of difficult leaves and try to pick them up. While some shots may look impossible every one can be picked up with enough practice.

The Rules and Scoring

Trick Shot has three kinds of shots: shots with only white pins, shots with white pins and red pins, and shots with white pins and targets on the lane. The player must knock down any white pins, avoid any red pins, and hit any targets to score. The shots are ranked by difficulty. The game adjusts the rankings of the shots over time based on the rate at which each shot is converted. Easier shots are worth fewer points while more difficult shots are worth more points.

Ten Pin Poker

Ten Pin Poker is played just like Regulation Ten Pin Bowling. Additionally, for each strike or spare the player gets a card (an operator adjustment can restrict cards to strikes only to increase the level of challenge). Each player can have up to five cards. At the end of the game the player with the best poker hand wins.

About the Games

The Rules and Scoring

Scoring is just like Regulation Ten Pin. Additionally, players are awarded a card for each mark. If a player already has five cards, he or she must discard before drawing a new card. The player may opt to stand. As the game progresses a marker on the score sheet will indicate the player or players with the high hand. Hands are ranked using standard poker rules:

1. straight flush – a straight, all of the same suit. The Royal Flush is the highest possible hand (10-J-Q-K-A, all the same suit)
2. four of a kind – four cards of the same rank
3. full house – a pair and three of a kind
4. flush – five cards of same suit
5. straight – five cards whose rank are sequential. Ace may be high or low but not both (can't wrap, like Q-K-A-2-3)
6. three of a kind – three cards of the same rank
7. two pairs
8. pair – two cards of the same rank
9. high card

Suits are equivalent, so if two players have hands of the same rank which differ only by suit those hands are considered equivalent.

Bowl21 Bowling

In Bowl21 Bowling, each player gets to throw at three full racks of ten pins each. The goal in each frame is to knock down 21 pins without going over. The player closest to 21 wins all the points for that frame.

The Rules and Scoring

Each player gets three full racks of ten pins per frame and tries to knock down a total of 21 pins without going over. Knocking down a single pin counts as an ace (one or eleven, whichever is better). All pins knocked down are added to the pot for that frame. Whichever player gets closest to 21 without going over wins all the pins in the pot for that frame while the other players mark zero. A bowl21 (a single pin and a strike—an ace and a ten or face card) beats 21 earned on three throws. Bowl21 doubles the number of points scored. In the event of a tie the pot is split evenly between the top scorers—any remainder in the pot carries over to the next round.. Also, if all players bust the entire pot carries over into the next round.

About the Games

Flash-O-Matic

A roving score value ranges from 100 to 800 points. The score stops moving on the first throw in a frame when the ball reaches the pins. The full score is awarded for a strike, half the score is awarded for a spare, and the number of pins knocked down is awarded on an open frame.

PARTS LIST

Operator's Manual

Part Number	Description
JB10-20504-00	ALUMINUM 1-1/2", 144" LENGTH (110 in) T-MOLDING
JB15-20501-00	MAIN PCB (NOT AVAILABLE CALL CUSTOMER SERVICE)
JB15-20502-00	TEST/VOL PCB
JB15-20503-00	MIC PCB
JB40-20512-00	DECAL, REPLAY/BACK BUTTON
JB40-20513-00	DECAL, SCORESHEET/TITLE BUTTON
JB40-20514-00	DECAL, JUKEBOX/NEXT BUTTON
JB40-20515-00	DECAL, START BUTTON
JB40-20516-00	CONTROL PANEL OVERLAY
JB40-20517-00	CABINET DECAL, SIDE LEFT
JB40-20518-00	CABINET DECAL, SIDE RIGHT
JB40-20519-00	DECAL, 4-POINT STAR
JB40-20520-00	DECAL, INNER/USB CONTROL PANEL
JB50-20530-00	HARNESS, DC PWR TO PCB
JB50-20530-01	HARNESS TOP SPEAKERS
JB50-20530-02	HARNESS, BTM SPKR PCB TO EXT
JB50-20530-03	HARNESS, BTM SPKR EXT TO SPKR
JB50-20530-04	HARNESS, SERVICE PANEL
JB50-20530-05	HARNESS, CONTROL PANEL
JB50-20530-06	HARNESS, MICROPHONE 1
JB50-20530-07	HARNESS, RGB PCB TO TB
JB50-20530-08	HARNESS, RGB TB TO CNTRL PNL
JB50-20530-09	HARNESS, RGB CNTRL PNL TO SIDE LED
JB50-20530-10	HARNESS, AC POWER PLATE
JB50-20530-11	HARNESS, PP TO PWS
JB54-20508-00	12" SUBWOOFER
JB54-20510-00	SPEAKER, RECOIL ECHO 5.25" COAX (PAIR)
JB64-20506-00	KNOB, 1/4" VOL CONTROL
JB80-20526-00	3" TRACKBALL
JB84-20527-00	MICROPHONE MCX10 KIT
JB90-20509-00	PLASTIC CUP HOLDER, 3 1/2" X 4"
JB90-20511-00	BOWLORAMA BOTTOM PLASTIC LOGO
JB97-20522-00	ACOUSTA-STUF POLYFILL
JB97-20528-00	CLOTH, SPEAKER GRILL TURQUOISE 36"
VG50-14135-00	LVDS CABLE FOR 27"
VG50-14136-00	BACKLIGHT CABLE FOR 27"
VG80-14054-00	PUSH BTN MED WHITE W/LED
VG85-13470-10	27" AUO MONITOR PANEL ONLY
VG88-20529-00	POWER SUPPLY 5V, 24V, 133W



**FOR REFERENCE PURPOSES ONLY,
PLEASE CONTACT US IF YOU REQUIRE ASSISTANCE**

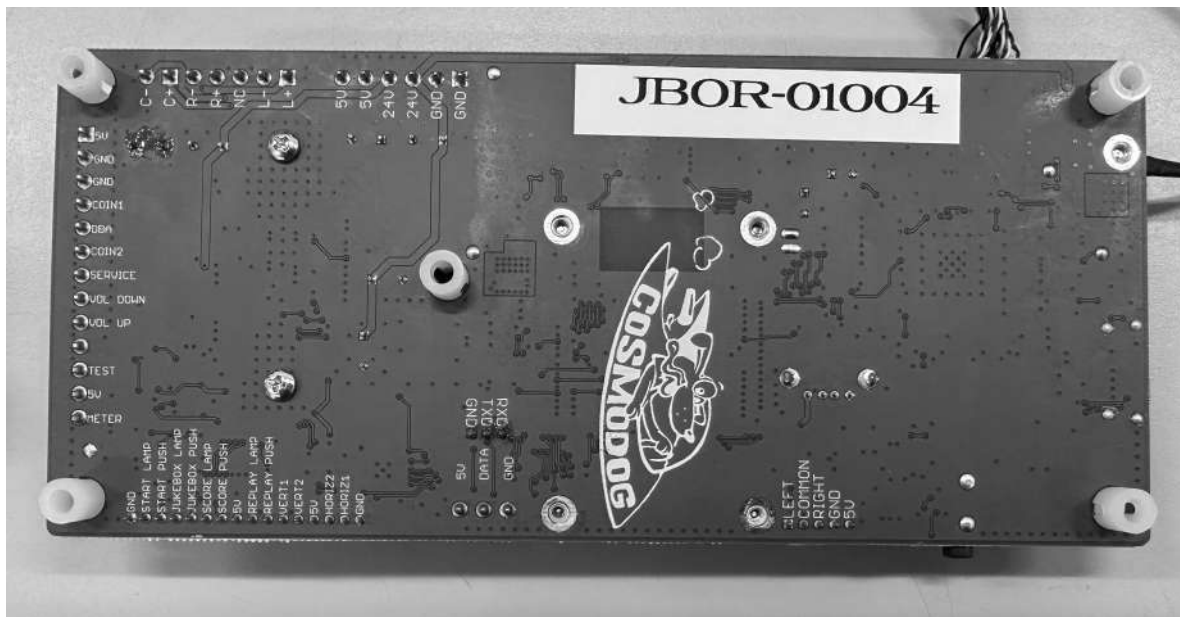

Have Questions? Contact us!

BANDAI NAMCO SERVICE CENTER

Tel: 847-264-5612

Email: PARTS@BANDAINAMCO-AM.COM

www.namcoparts.com

WIRING DIAGRAM

Operator's Manual

This is diagram is for reference purposes **ONLY**. If you require support please contact our customer support department at the following:

Tel: 847-264-5614

Email:

PARTS@BANDAINAMCO-AM.COM

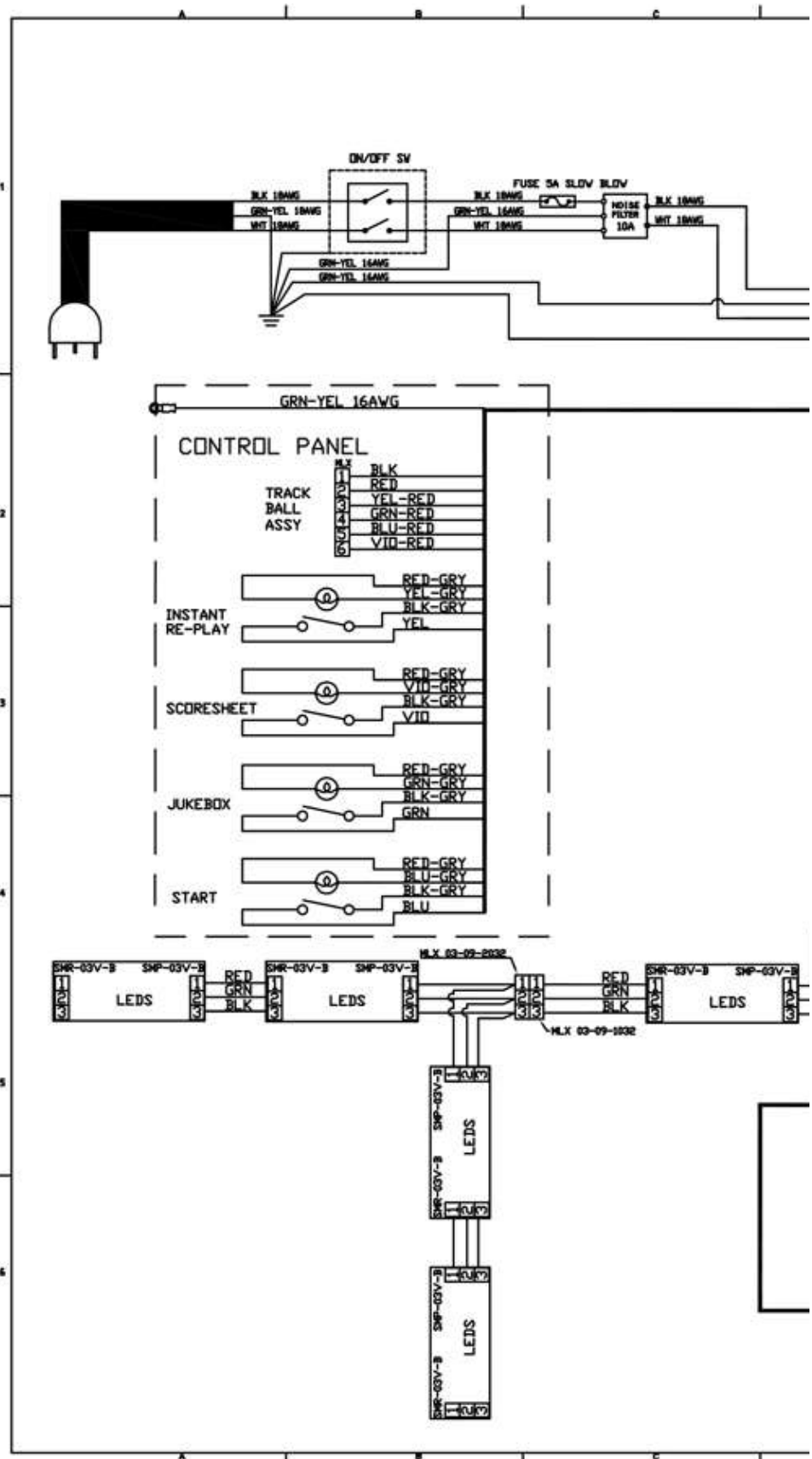

Operator's Manual

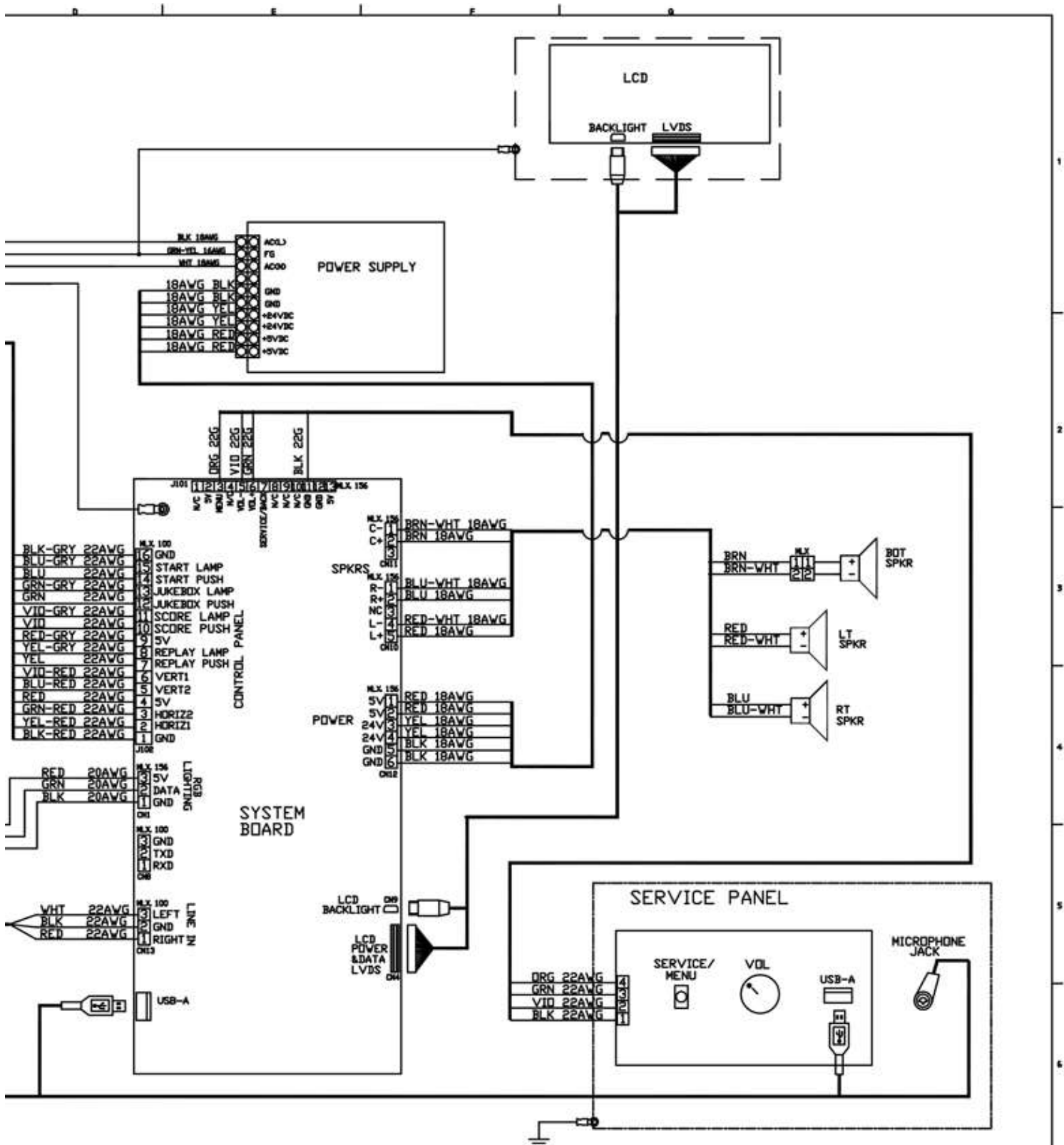

NAMCO JBOR

- REV B

(1/1)



BANDAI NAMCO

**Bandai Namco
Amusement America Inc.**

1550 Glenlake Ave
Itasca, IL 60143
www.bandainamco-am.com

Technical Support Contacts (USA)

Technical Service:
+1 (847) 264-5614

Parts:
+1 (847) 264-5612
www.namcoparts.com

Copies of the this manual can be downloaded from our
website: www.bandainamco-am.com