

# Furniture Foosball

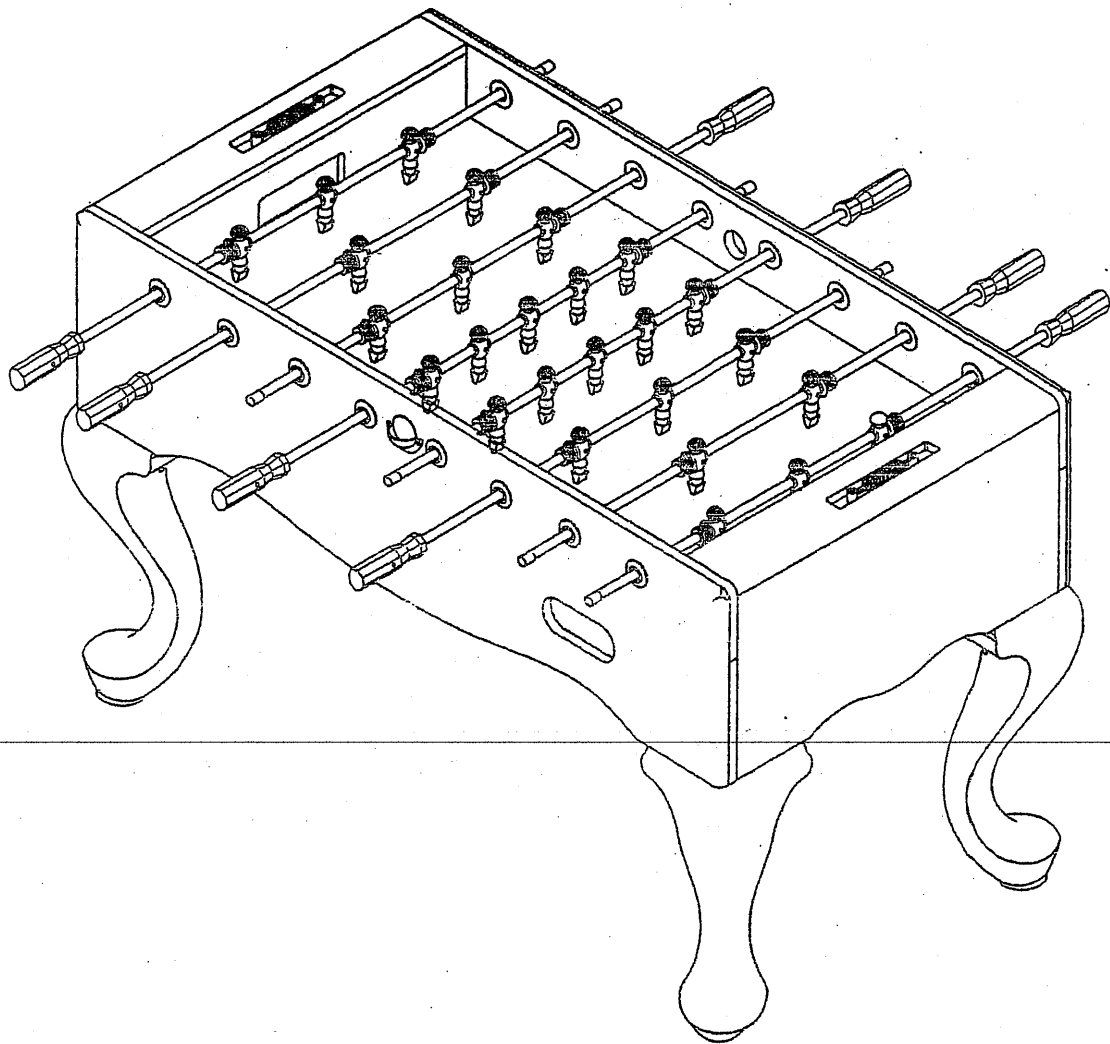

furniture foosball

# ASSEMBLY INSTRUCTION

## STEP 1

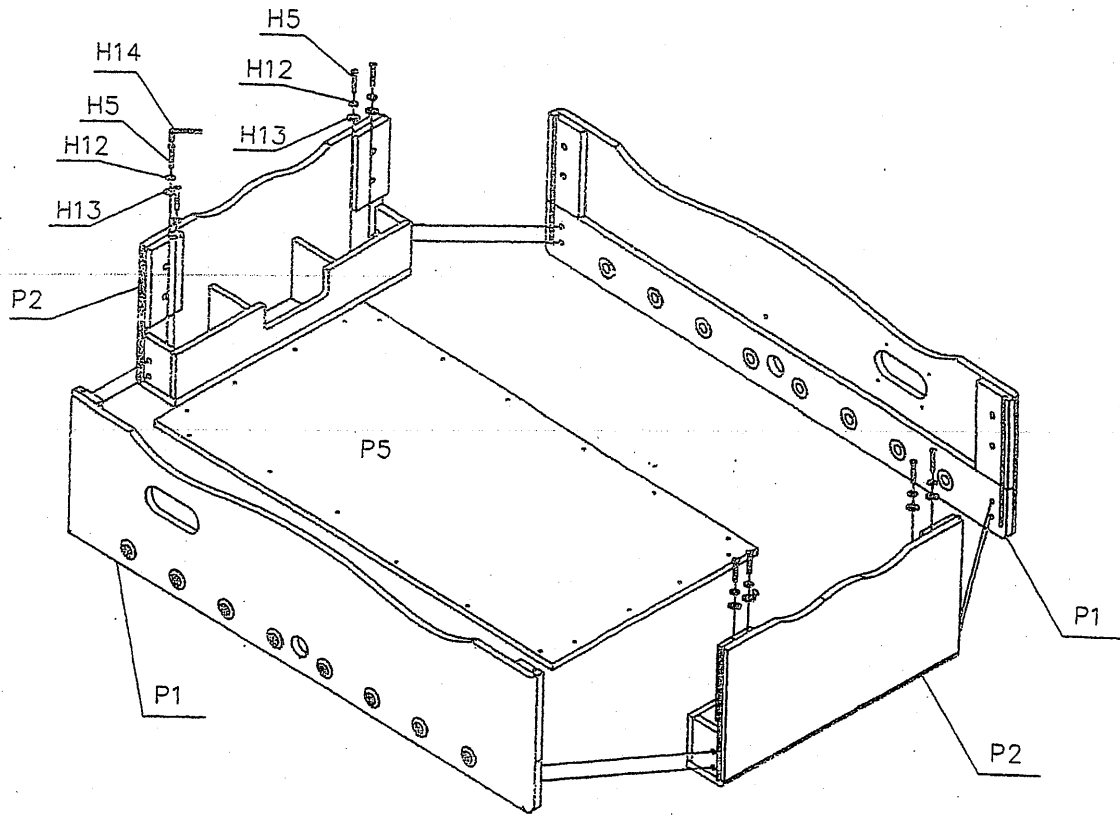

## STEP 2

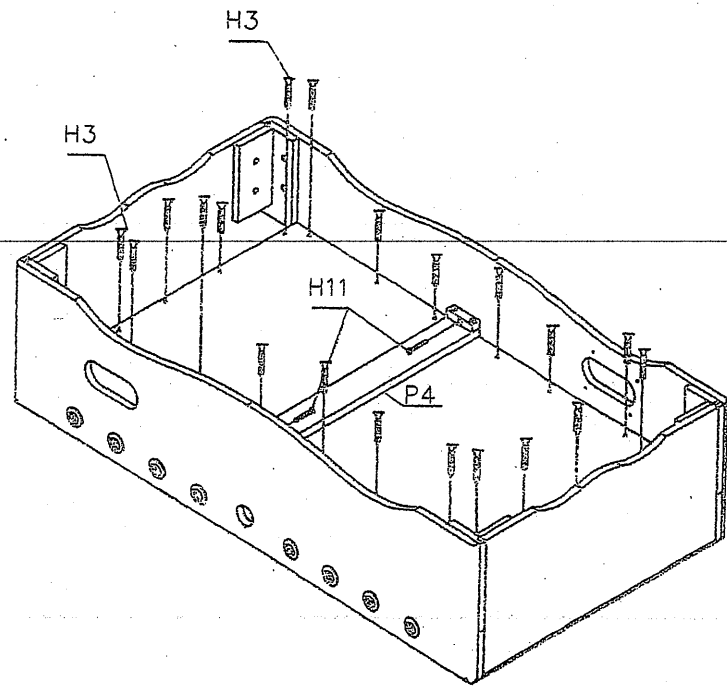

# Furniture Foosball

## ASSEMBLY INSTRUCTION

### STEP 3

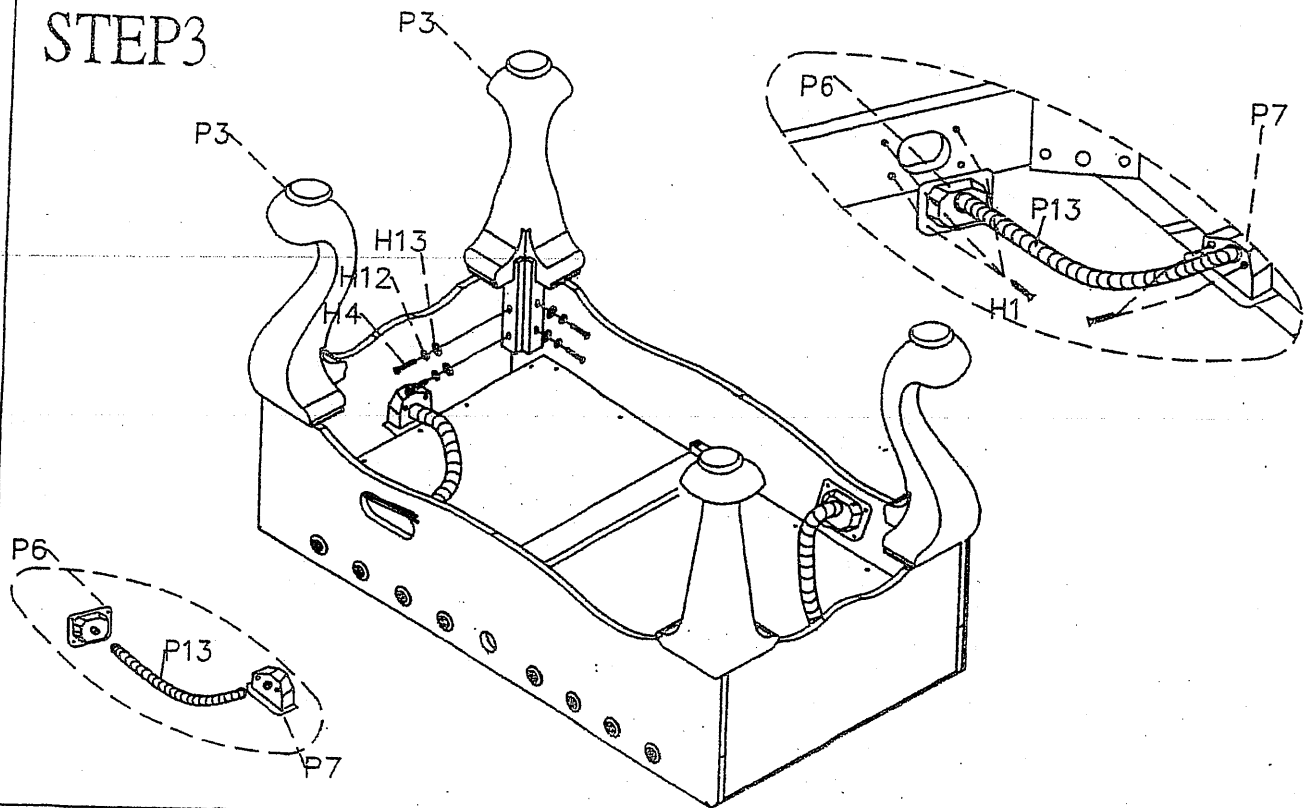

### STEP 4

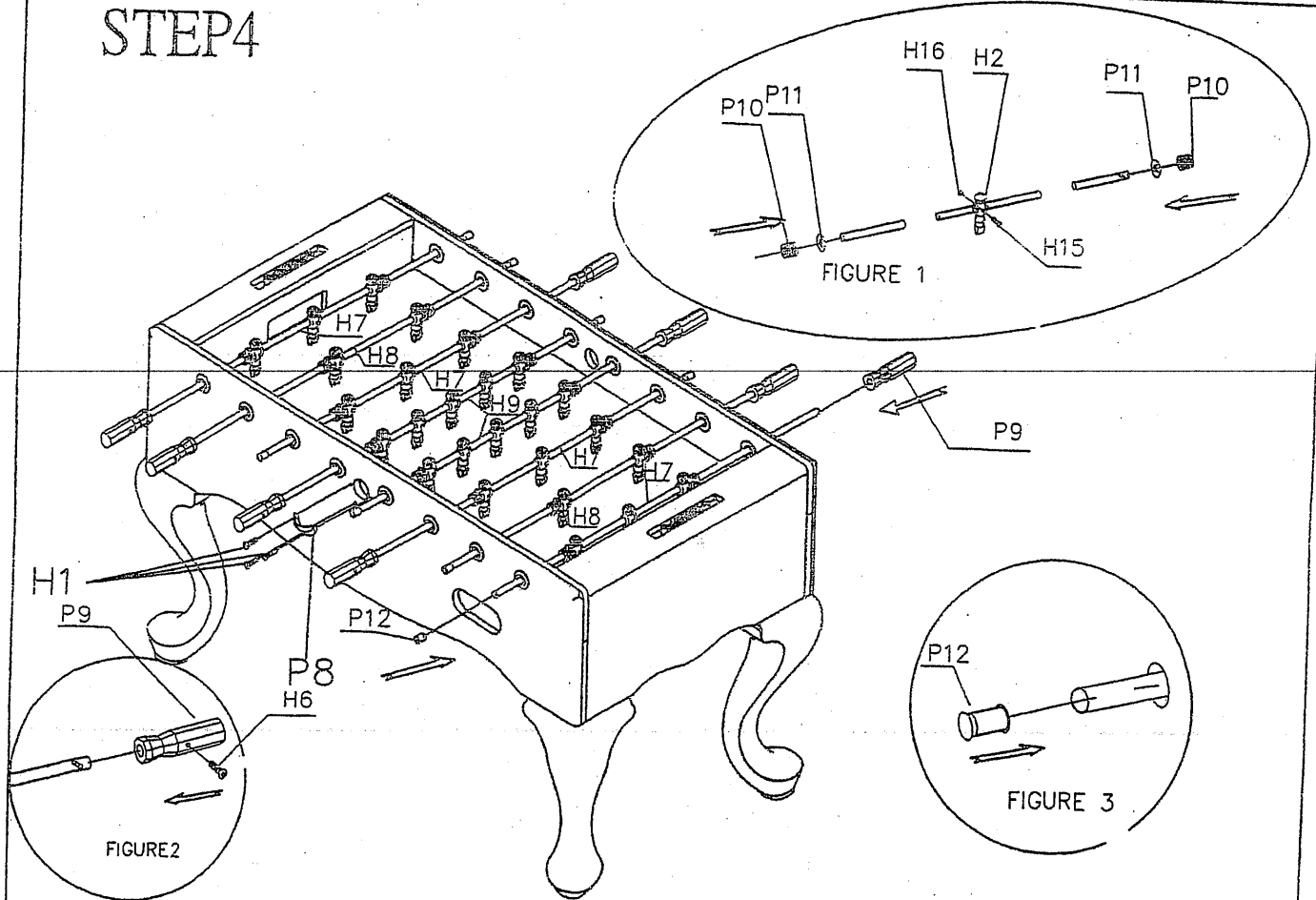

# Furniture Football

## PARTS LIST

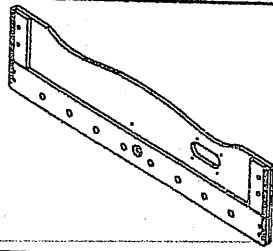

P1

Long apron

2PCS

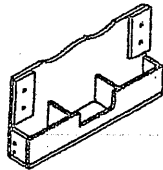

P2

Short apron

2PCS

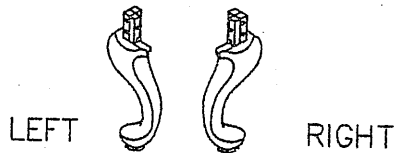

P3

Leg

4 PCS



P4

Support beam

1 PC



P5

Playfield

1 PC



P6

Ball catcher

2 PCS

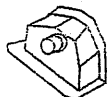

P7

Goal

2 PCS



P8

ball entry ring

2 PCS



P9

Handle

8 PCS



P10

Rubber bushing

16 PCS



P11

Plastic rod  
washer

16 PCS



P12

Rod cap

8 PCS

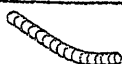













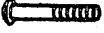

P13

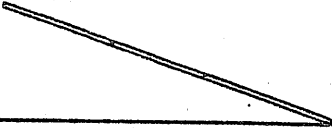
Ball runner

2 PCS

# Furniture Foosball

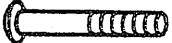
## PARTS LIST

	H1(6*15)	screw	18 PCS
	H2	plastic man	26 PCS
	H3(#8*1")	screw	20 PCS
	H4( $\phi$ 5/16**3-1/4")	bolt	16 PCS
	H5( $\phi$ 5/16**1-1/4")	bolt	8 PCS
	H6( $\phi$ 3/16**3/4")	bolt	8 PCS
	H7	pipe	4 PCS
	H8	pipe	2 PCS
	H9	pipe	2 PCS
	H10	soccer ball	4 PCS
	H11(1/4**1")	bolt	2 PCS
	H12(5/16")	spring washer	24 PCS
	H13(5/16**20)	washer	24 PCS
	H14(5mm)	wrench	1 PC
	H15(5/32*1-1/8")	bolt	26 PCS
	H16(5/32**9*6)	nut	26 PCS