



F.Y.C KIDDY RIDE INSTRUCTION MANUAL

FC-081 Super Helicopter



Specification

Dimension L195 x W90 x H210 cm

Weight 130 kgs

Voltage 110V AC, 60Hz, 3A, Max 6A
220V AC, 50Hz, 3A, Max 6A

F.Y.C KIDDY RIDE INSTRUCTION MANUAL

Super Helicopter FRP Model Assembly

Super Helicopter Detail Manual

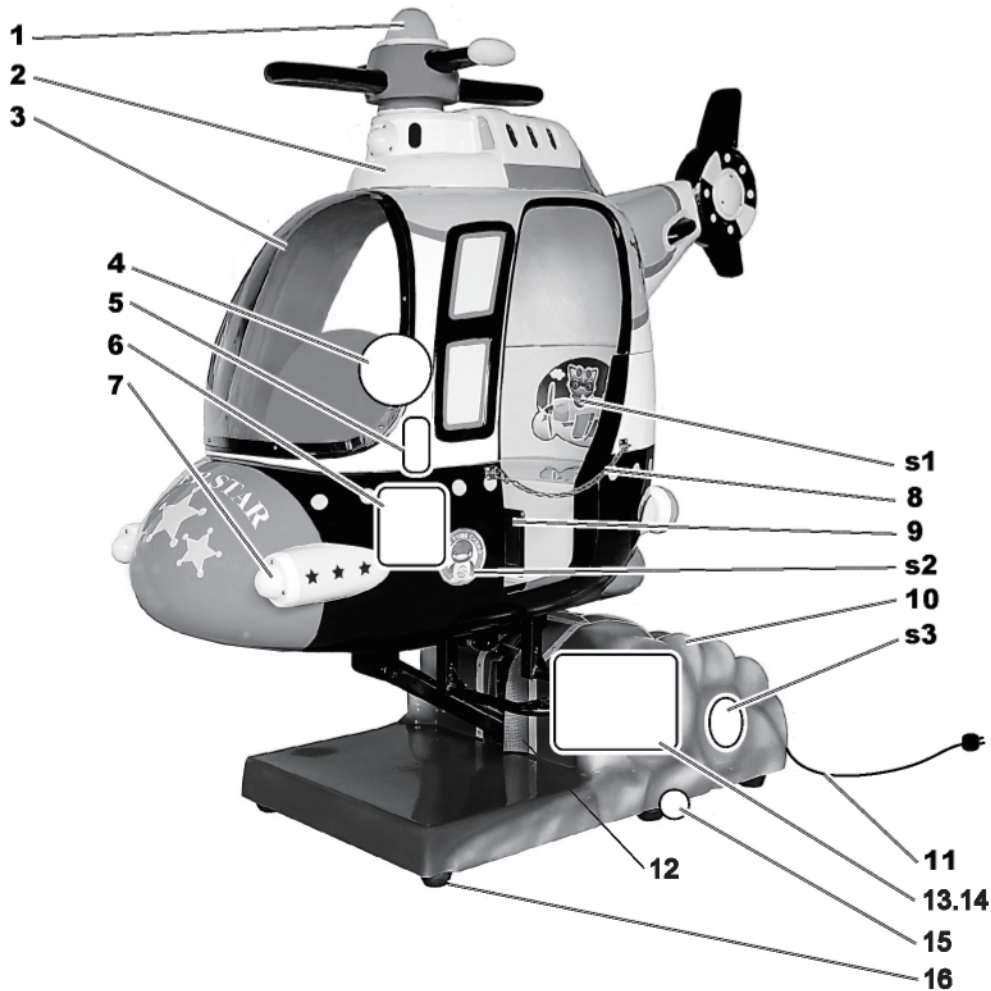

- 1. Light#13
- 2. Super Helicopter FRP
- 3. Acrylic cover#3
- 4. Steering wheel#2
- 5. Electronic coin machine(key#1)
- 6. Coin box(key#2)
- 7. Light#2
- 8. Metal chain
- 9. Maintenance door-medium(key#1)

- 10. Base of cloud shape
- 11. Power-plug locates at rear of base
- 12. Speaker
- 13. Control door (key#1)
- 14. Control & Music Box
- 15. Wheel
- 16. Fixer

- s1~s2. Sticker
- s3. Warning sign sticker

F.Y.C KIDDY RIDE INSTRUCTION MANUAL

FC-P0026 Electronic Coin Machine

Electronic Coin Machine Operating Manual

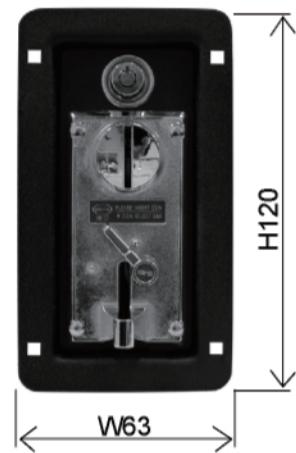
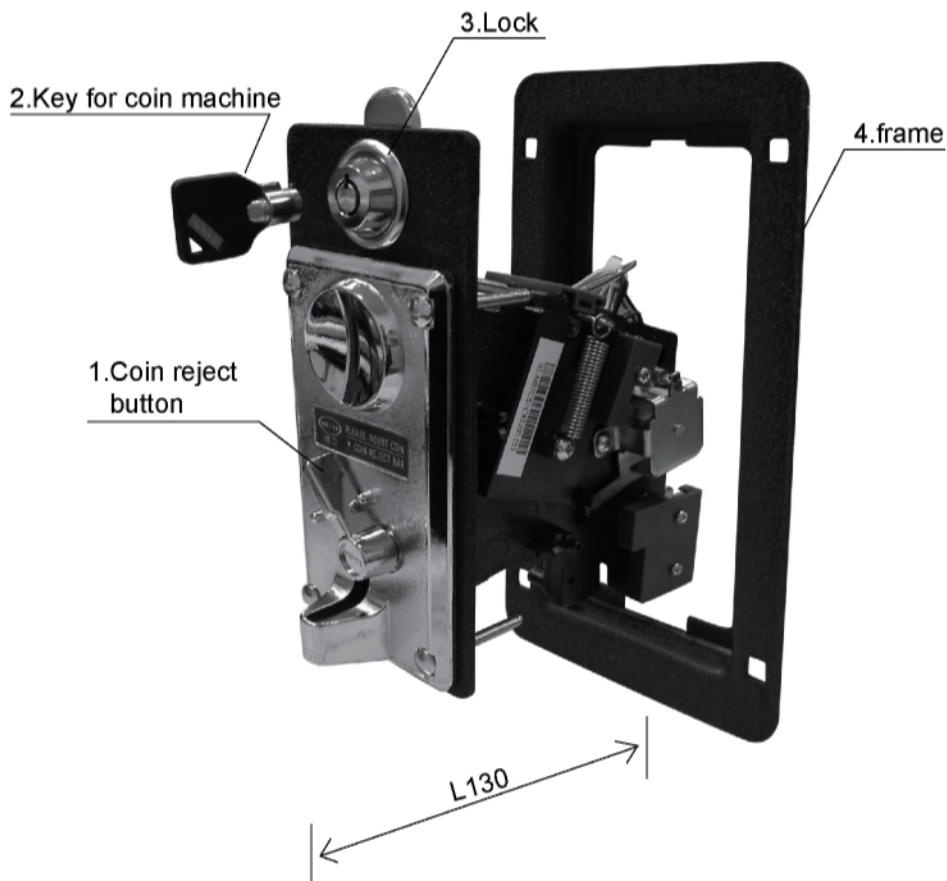

size:mm

F.Y.C KIDDY RIDE INSTRUCTION MANUAL

FC-P0026 Electronic Coin Machine

Electronic Coin Machine Operating Manual

DIDGITAL COMPARABLE ELECTRONIC

INSTALLATION HI-07CS+LED

STEP1

Cheng the right coin for use from the clamp.

STEP2

Adjust the right insert size for use from the front panel back side.

STEP3

Select the right mode: Normal Open/ Normal Close" TIMER SWITCH" for synchronizing your system.

100ms (Slow Speed/ Long Pulse)

50ms (Medium Speed/ Medium Pulse)

30ms (Fast Speed/ Short Pulse)

STEP4

Adjust VR sensitivity tuning

Clockwise: slack selection (LED dark->light)

Anti-clockwise: strict selection (LED light->dark)

STEP5

Gray Line Counter (+/-)

Red Line DC+12V

White Line Coin Signal

Black LINE GND (Ground)

Gray Line Counter (+/-)

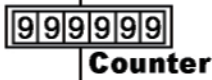

Counter

STEP6

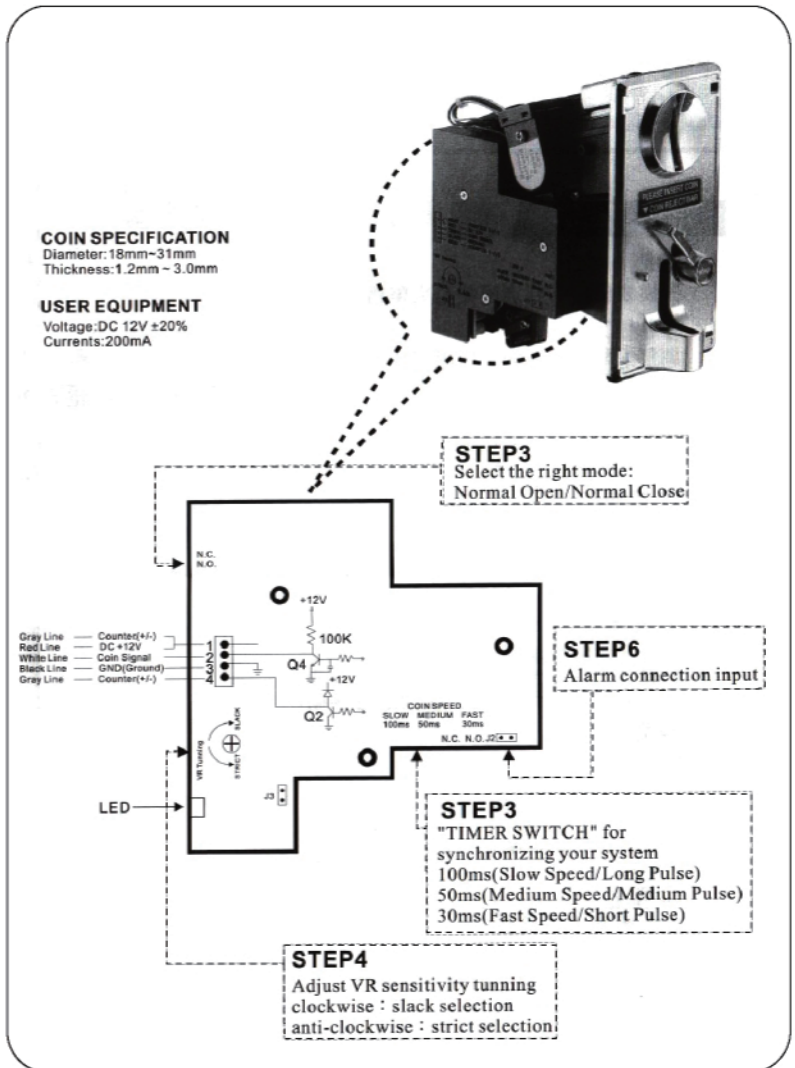
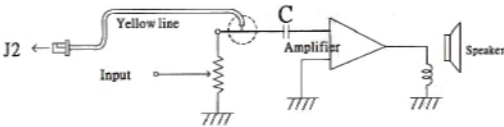

F.Y.C KIDDY RIDE INSTRUCTION MANUAL

FC-P0007 Coin Box

Coin Box Manual

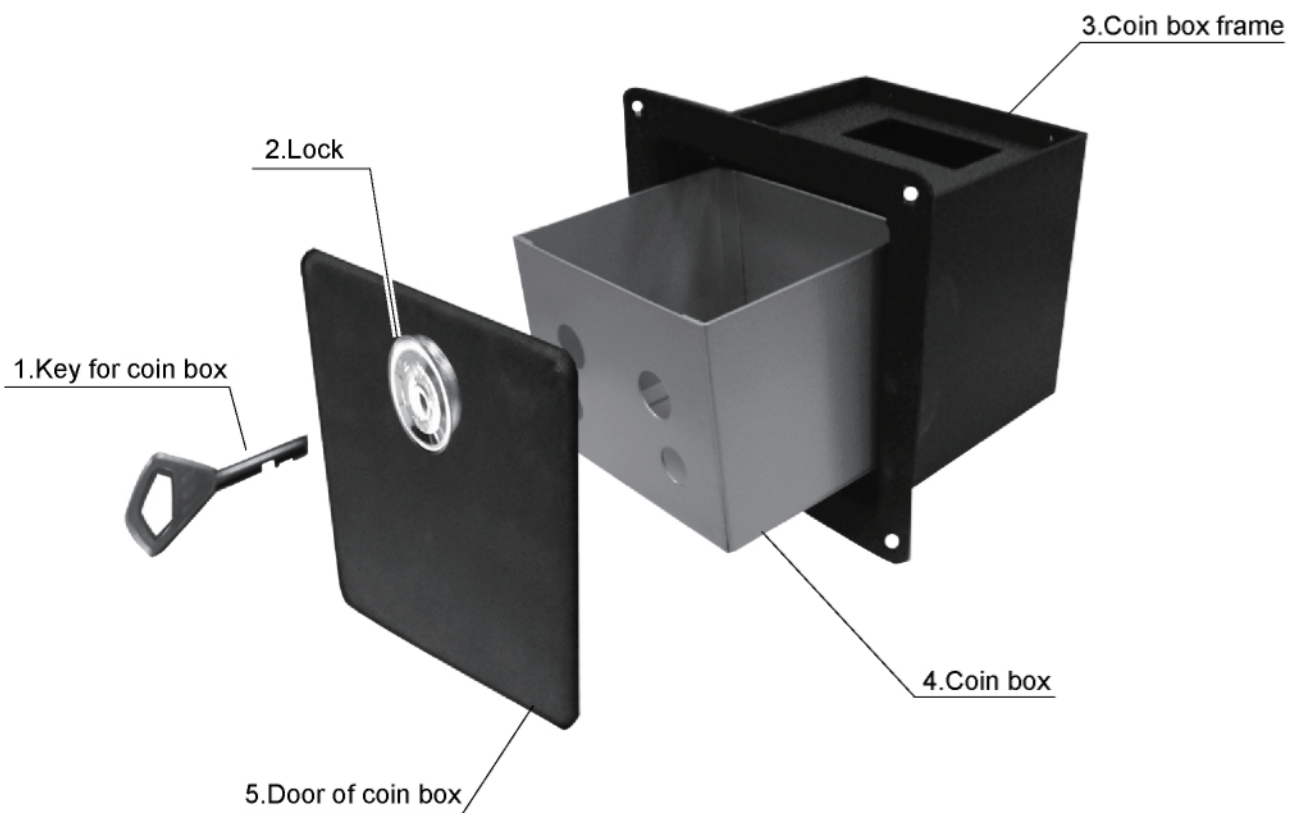

size: W175mm x L145mm x H175mm

F.Y.C KIDDY RIDE INSTRUCTION MANUAL

FC-P0030 Maintenance Door-Medium

Maintenance Door-Medium Manual



size: W164mm x L20mm x H272mm

F.Y.C KIDDY RIDE INSTRUCTION MANUAL

OPERATION MANUAL - SILVER CONTROL & MUSIC BOX

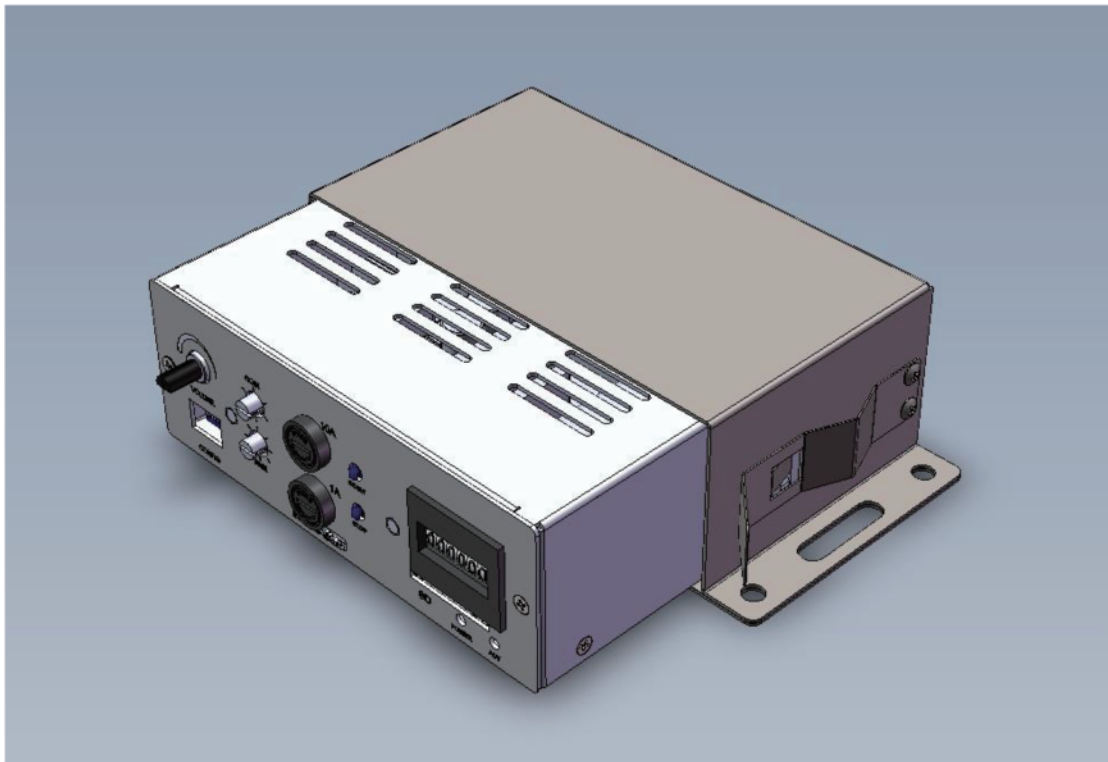

CONTENT

1. Function Introduction
2. Specification Introduction
3. Function Description :

Control Panel

Connect Panel

SD CARD Set Up Introduction

Music Installation

4. Attention
5. Rear Panel Pin Assignment

F.Y.C KIDDY RIDE INSTRUCTION MANUAL

1. Function Introduction

The equipment is for Kiddy Ride machine only.

Function and feature:

1. 15W sound-stereo · and volume adjustment.
2. Set up the meter value by coin or play-time.
3. Multiple coins value set up for game-play.
4. Multiple times value set up for game-play.
5. AC Power 10A fuse · DC Power 5A fuse protection.
6. Use the mechanical-meter to count the coins or game-play.
7. The SD Card save music and may change the music by operator.
8. Power and Action led light directive for working.

F.Y.C KIDDY RIDE INSTRUCTION MANUAL

2. Specification Introduction

MUSIC BOX

Specification	
AC input	AC 85V~265V 50/60Hz
AC output (motor)	AC110 / AC220V , 10A
DC12V output	4A (TOTAL)
Speaker	15W / 8Ω STERO
Music Storage	SD CARD (Up To 8G)
Music Format	MP3
AC Fuse	10A
DC Fuse	4 A
Weight	1.5 KG
Dimension	D:187mm x W:208mm x H:58mm

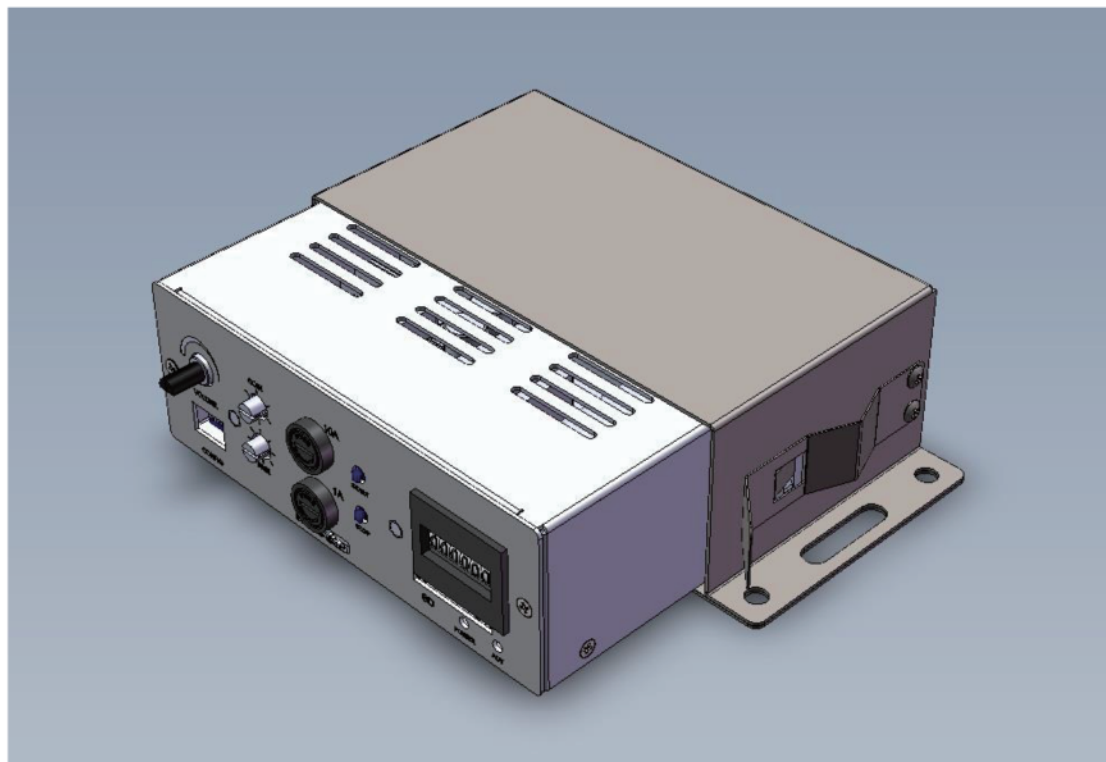

F.Y.C KIDDY RIDE INSTRUCTION MANUAL

Main Unit

Specification

Dimension D : 170mm x W : 168mm x H : 54mm



Connect Unit

Specification

Dimension D : 90mm x W : 208mm x H : 58mm

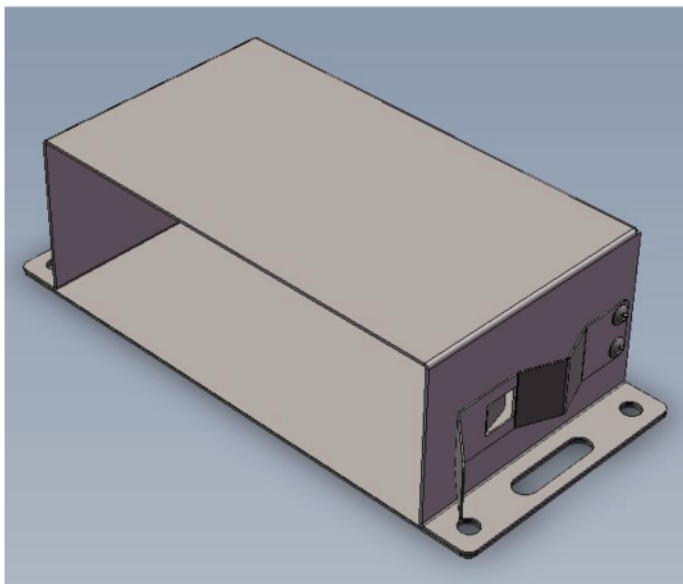

F.Y.C KIDDY RIDE INSTRUCTION MANUAL

3. Function Description :

Control Panel

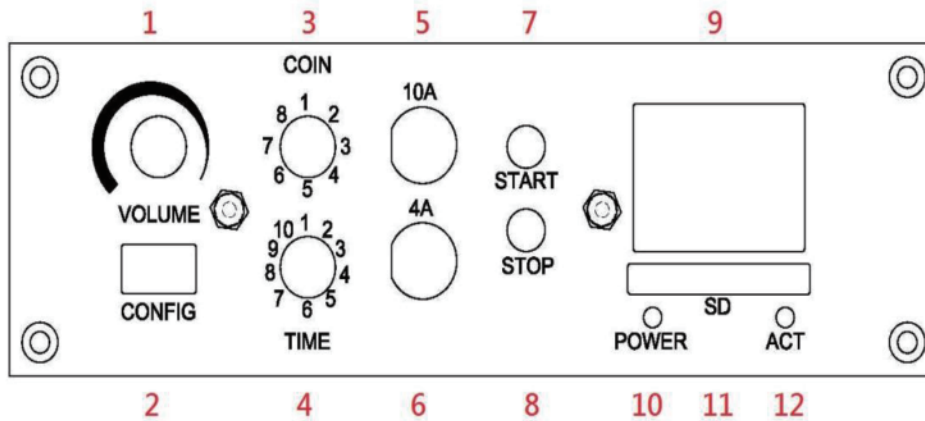

NOTE

For each function change, the unit must reboot (power off/on) and the function is working.

1.	VOLUME	Volume adjustment																																																																		
2.	FUNCTION SETTING 	<table border="1"> <thead> <tr> <th>1</th> <th>2</th> <th>3</th> <th>4</th> <th>5</th> <th></th> </tr> </thead> <tbody> <tr> <td>○</td> <td></td> <td></td> <td></td> <td></td> <td>Coin Start</td> </tr> <tr> <td>×</td> <td></td> <td></td> <td></td> <td></td> <td>Button Start</td> </tr> <tr> <td></td> <td>○</td> <td></td> <td></td> <td></td> <td>Coin Record</td> </tr> <tr> <td></td> <td>×</td> <td></td> <td></td> <td></td> <td>Coin Unrecorded</td> </tr> <tr> <td></td> <td></td> <td>×</td> <td></td> <td></td> <td>Coin Selector- NO</td> </tr> <tr> <td></td> <td></td> <td>○</td> <td></td> <td></td> <td>Coin Selector- NC</td> </tr> <tr> <td></td> <td></td> <td></td> <td>○</td> <td></td> <td>Testing Mode</td> </tr> <tr> <td></td> <td></td> <td></td> <td>×</td> <td></td> <td>Normal Mode</td> </tr> <tr> <td></td> <td></td> <td></td> <td></td> <td>○</td> <td>Coin Counter</td> </tr> <tr> <td></td> <td></td> <td></td> <td></td> <td>×</td> <td>Game-Play Counter</td> </tr> </tbody> </table> <p>Testing Mode : The cycle work 60 sec and then stop 60 sec. Normal Mode : The business mode. Coin Counter : The meter work for every coin. (1Coin 1 Play) Game-Play Counter : The meter work for every game-play.</p>	1	2	3	4	5		○					Coin Start	×					Button Start		○				Coin Record		×				Coin Unrecorded			×			Coin Selector- NO			○			Coin Selector- NC				○		Testing Mode				×		Normal Mode					○	Coin Counter					×	Game-Play Counter
1	2	3	4	5																																																																
○					Coin Start																																																															
×					Button Start																																																															
	○				Coin Record																																																															
	×				Coin Unrecorded																																																															
		×			Coin Selector- NO																																																															
		○			Coin Selector- NC																																																															
			○		Testing Mode																																																															
			×		Normal Mode																																																															
				○	Coin Counter																																																															
				×	Game-Play Counter																																																															

F.Y.C KIDDY RIDE INSTRUCTION MANUAL

3.	COIN SETTING	<p>Turn the knob to direct number and the function as follow :</p> <table border="1" data-bbox="608 320 1345 786"> <thead> <tr> <th>Position</th> <th>Function</th> </tr> </thead> <tbody> <tr> <td>1</td> <td>1Coin 1 Play</td> </tr> <tr> <td>2</td> <td>2 Coins 1 play</td> </tr> <tr> <td>3</td> <td>3 Coins 1 play</td> </tr> <tr> <td>4</td> <td>4 Coins 1 play</td> </tr> <tr> <td>5</td> <td>5 Coins 1 play</td> </tr> <tr> <td>6</td> <td>6 Coins 1 play</td> </tr> <tr> <td>7</td> <td>7 Coins 1 play</td> </tr> <tr> <td>8</td> <td>8 Coins 1 play</td> </tr> </tbody> </table>	Position	Function	1	1Coin 1 Play	2	2 Coins 1 play	3	3 Coins 1 play	4	4 Coins 1 play	5	5 Coins 1 play	6	6 Coins 1 play	7	7 Coins 1 play	8	8 Coins 1 play				
Position	Function																							
1	1Coin 1 Play																							
2	2 Coins 1 play																							
3	3 Coins 1 play																							
4	4 Coins 1 play																							
5	5 Coins 1 play																							
6	6 Coins 1 play																							
7	7 Coins 1 play																							
8	8 Coins 1 play																							
4.	<p>TIME The Game-Play time setup.</p>	<p>Turn the knob to direct number and the function as follow :</p> <table border="1" data-bbox="608 904 1345 1476"> <thead> <tr> <th>Position</th> <th>Function</th> </tr> </thead> <tbody> <tr> <td>1</td> <td>The Game-Play time : 30 sec.</td> </tr> <tr> <td>2</td> <td>The Game-Play time : 60 sec.</td> </tr> <tr> <td>3</td> <td>The Game-Play time : 90 sec.</td> </tr> <tr> <td>4</td> <td>The Game-Play time : 120 sec.</td> </tr> <tr> <td>5</td> <td>The Game-Play time : 150 sec.</td> </tr> <tr> <td>6</td> <td>The Game-Play time : 180 sec.</td> </tr> <tr> <td>7</td> <td>The Game-Play time : 210 sec.</td> </tr> <tr> <td>8</td> <td>The Game-Play time : 240 sec.</td> </tr> <tr> <td>9</td> <td>The Game-Play time : 270 sec.</td> </tr> <tr> <td>10</td> <td>The Game-Play time : 300 sec.</td> </tr> </tbody> </table>	Position	Function	1	The Game-Play time : 30 sec.	2	The Game-Play time : 60 sec.	3	The Game-Play time : 90 sec.	4	The Game-Play time : 120 sec.	5	The Game-Play time : 150 sec.	6	The Game-Play time : 180 sec.	7	The Game-Play time : 210 sec.	8	The Game-Play time : 240 sec.	9	The Game-Play time : 270 sec.	10	The Game-Play time : 300 sec.
Position	Function																							
1	The Game-Play time : 30 sec.																							
2	The Game-Play time : 60 sec.																							
3	The Game-Play time : 90 sec.																							
4	The Game-Play time : 120 sec.																							
5	The Game-Play time : 150 sec.																							
6	The Game-Play time : 180 sec.																							
7	The Game-Play time : 210 sec.																							
8	The Game-Play time : 240 sec.																							
9	The Game-Play time : 270 sec.																							
10	The Game-Play time : 300 sec.																							
5.	AC Fuse	10A																						
6.	DC Fuse	4 A																						
7.	START BUTTON	Press the button for game start.																						
8.	STOP BUTTON	Press the button for game stop.																						
9.	METER	The mechanical-meter to count the coins or game-play.																						
10	SD Card	For SD Card install and work.																						
11.	POWER	Power led light directive for working.																						
12.	ACT	ACT led light directive for working.																						

F.Y.C KIDDY RIDE INSTRUCTION MANUAL

Connect Panel

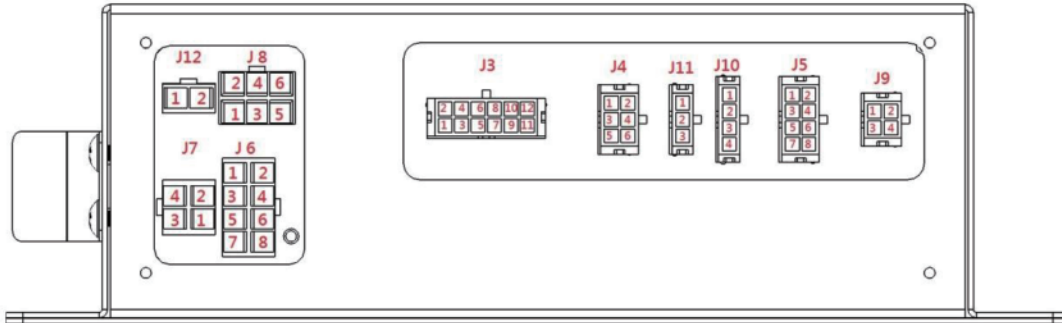

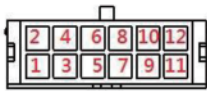
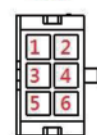

J3 12-PIN LED LAMP  *NOTE 1	1	GND	GND
	2	The game-playing and DC power output.	DC 12V
	3	GND	GND
	4	The game-playing and DC power output.	DC 12V
	5	GND	GND
	6	The game-playing and DC power output per 0.5 sec.	DC 12V
	7	GND	GND
	8	The game-playing and DC power output per 0.5 sec.	DC 12V
	9	GND	GND
	10	The unit power-on and DC power output.	DC 12V
	11	GND	GND
	12	The unit power-on and DC power output.	DC 12V
J46-PIN COIN 	1	Coin Power VCC	DC 12V
	2	Coin Power GND	GND
	3	Coin Signal	SIGNAL
	4	Start-Button light GND	GND
	5	enable VCC	DC 12V
	6	NO USE	NO USE

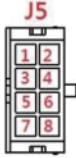
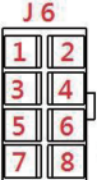
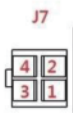
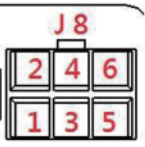
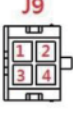
F.Y.C KIDDY RIDE INSTRUCTION MANUAL

J5 8-PIN EFFECT SWITCH 	1	Start-Button	SW-1-NO
	2	Start-Button	SW-1-COM
	3	Effect-Button -1-	SW-2-NO
	4	Effect-Button -1-	SW-2-COM
	5	Effect-Button -2-	SW-3-NO
	6	Effect-Button -2-	SW-3-COM
	7	NO USE	NO USE
	8	NO USE	NO USE
J6 8-PIN AC INPUT 	1	AC INPUT GND	AC INPUT 85V~265V MAX 10A
	2	AC INPUT GND	
	3	AC INPUT L	
	4	AC INPUT N	
	5	AC INPUT L	
	6	AC INPUT N	
	7	AC INPUT L	
	8	AC INPUT N	
J7 4-PIN AC OUTPUT 	1	AC OUTPUT N	AC OUTPUT 85V~265V
	2	AC OUTPUT GND	
	3	AC OUTPUT L	
	4	AC OUTPUT GND	
J8 6-PIN MOTOR AC POWER 	1	MOTOR AC OUTPUT L	110V/220V MAX 10A
	2	MOTOR AC OUTPUT L	
	3	MOTOR AC OUTPUT N	
	4	MOTOR AC OUTPUT N	
	5	MOTOR AC OUTPUT GND	
	6	MOTOR AC OUTPUT GND	
J9 4-PIN RS 232 	1	RS232 COM	
	2	RS232 TX	
	3	RS232 COM	
	4	RS232 RX	

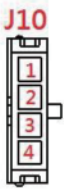
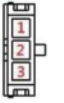
F.Y.C KIDDY RIDE INSTRUCTION MANUAL

J10 4-PIN SOUND 	1	SPEAKER R+	15W/8Ω
	2	SPEAKER R-	
	3	SPEAKER L-	
	4	SPEAKER L+	
J11 3-PIN LIMIT SWITCH 	1	+12v	
	2	SIGNAL	
	3	GND	
J12 2-PIN MOTOR AC LAMP 	1	MOTOR AC LAMP OUTPUT L	110V/220V
	2	MOTOR AC LAMP OUTPUT N	

***NOTE 1 : DC 12V power output maximum is 4A ◦**

F.Y.C KIDDY RIDE INSTRUCTION MANUAL

SD CARD Set Up Introduction

Tools : Flathead screwdriver 、 SD CARD ◦



Install :

Insert the SD CARD into the slot then use the flathead screwdriver to press it.

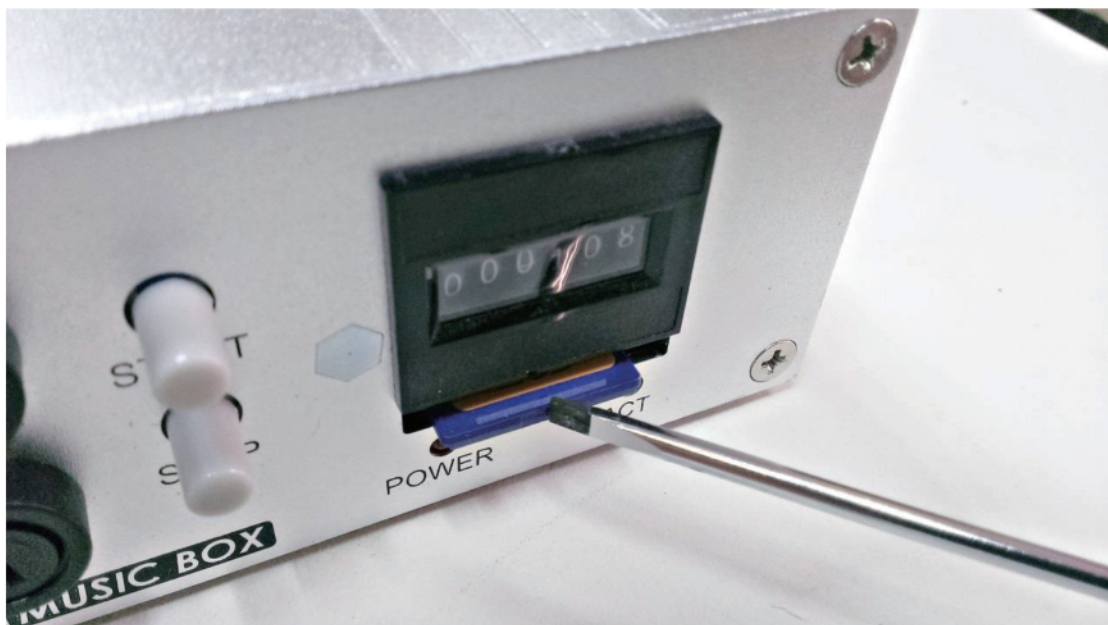

F.Y.C KIDDY RIDE INSTRUCTION MANUAL

Press to bottom and the SD CARD stuck. The install finished.

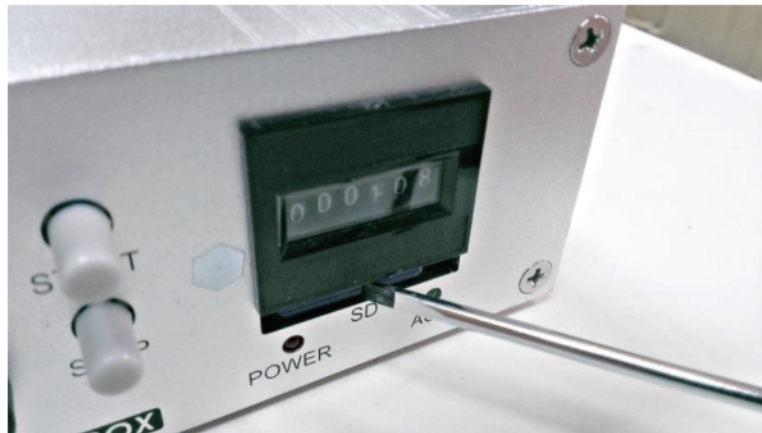

Uninstall

Use the flathead screwdriver to press the SD CARD to bottom. And the slot will release the SD CARD.

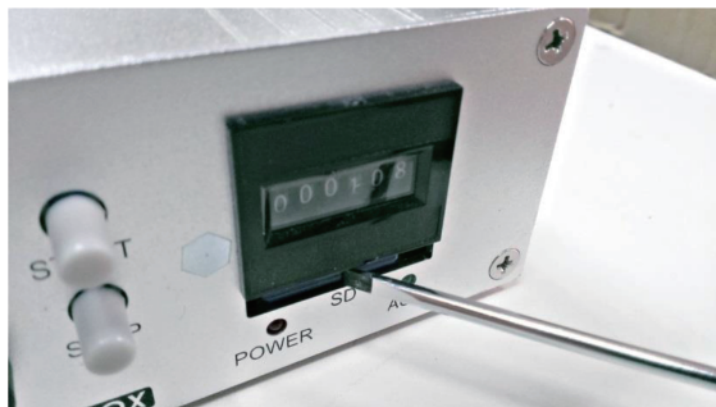

Remove the flathead screwdriver and the SD CARD eject. And then take out the SD CARD.



F.Y.C KIDDY RIDE INSTRUCTION MANUAL

Music Installation

1. Set up the folders are named as below in the SD CARD.

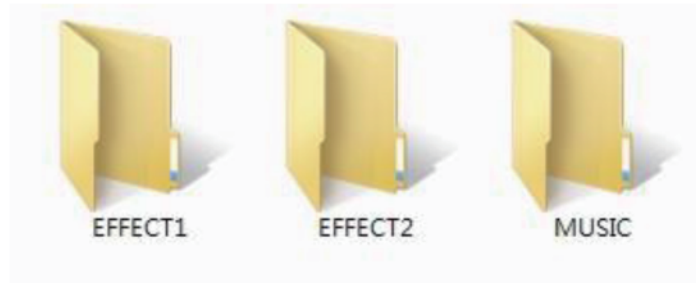

2. Saving music files to the folder as your require and file type is .mp3.
3. MUSIC : The game-play mode use and play by turns.

EFFECT1 : Press Effect-Button -1-, the mode use and play by turns.

EFFECT2 : Press Effect-Button -2-, the mode use and play by turns.

4. Attention

** The equipment for maintenance staff operate only.

** Power off to remove the Main Unit.

** Please follow the operation manual to operate the equipment.

F.Y.C KIDDY RIDE INSTRUCTION MANUAL

Rear Panel Pin Assignment

