

ASSEMBLY INSTRUCTIONS



Brazos River 14' Shuffleboard Table

Models:

Chestnut - SHBRRCHT14

Espresso - SHBRRESP14

Weathered Black - SHBRRBLK14

Weathered Brown - SHBRRBRO14



Congratulations on selecting a Brazos River shuffleboard table, part of the Fairfield Collection by Playcraft. Please contact us toll free at (888) 367-3095 or via email at support@playcraft.com should you require any assistance.

Please carefully read all safety instructions and directions before proceeding

- 1) Your table is designed for use indoors in a climate controlled environment only. Damage can occur if the table is exposed to water, dampness, high humidity, freezing temperatures, etc.
- 2) The shuffleboard cradle and playfield are extremely heavy. Two or more people are required for assembly.
- 3) The table must be assembled in the final location where the table will be played. Attempting to move the table once assembled could result in damage to the table or serious injury.
- 5) Only use the table for its intended purpose
- 6) Damaged or worn parts may be dangerous for users and the integrity of the table. Replace worn or damaged components immediately and do not use the table until any issues have been resolved. For best results, use only spare parts supplied by Playcraft.
- 7) Unauthorized repairs or altering the table's design or functions may be dangerous and will void the warranty.
- 8) Check all screws, bolts, etc. on a regular basis to ensure that they are in good working condition and have not loosened over time.
- 9) Over time, shuffleboard table cradles may require leveling and the playfield climatic adjusters may require adjusting. This is considered normal maintenance as required with owning a shuffleboard table



Parts List					
	PART #	IMAGE	DESCRIPTION	QTY	
CRADLE & LEGS	1		END LEG	2	
	2		CENTER LEG	1	
	3		LONG CENTER BEAM	2	
	4		ANGLED SUPPORT BEAM	4	
	5		BUTCHER BLOCK PLAYFIELD	1	
	6		CRADLE	2	
HARDWARE	LEG	H1		HANGER BOLT - 3/8" x 4-5/8"	4
		H2		FLAT WASHER - 3/8" ID	4
		H3		HEX NUT - 3/8" ID	4
		H4		HEX BOLT - 3/8" x 3-1/8"	4
		H5		FLAT WASHER - 3/8" ID	4
		H6		HEX BOLT - 5/16" x 2"	12
		H7		FLAT WASHER - 5/16" ID	12
		H8		HEX BOLT - 3/8" x 2-3/8"	4
		H9		FLAT WASHER - 3/8" ID	2
	CRADLE	H10		HANGER BOLT - 3/8" x 4-5/8"	4
		H11		FLAT RECTANGLE WASHER - 5/16" ID	4
		H12		HEX NUT - 3/8" ID	4
		H13		HEX HEAD CROSS BOLT - 5/16" x 2"	6
		H14		FLAT WASHER - 5/16" ID	6
		H15		FLAT HEAD SCREW - 5/16" x 1"	48
		H16		FLAT WASHER - 5/16" ID	48
		H17		CLIMATE ADJUSTER	4
PLAYING EQUIPMENT / ACCESSORIES			PREMIUM WEIGHT SET - 4 BLUE & 4 RED	1	
			Playcraft SPEED WAX - Medium 1 LB CAN	1	
			BOARD SWEEP	1	

FIG. 1

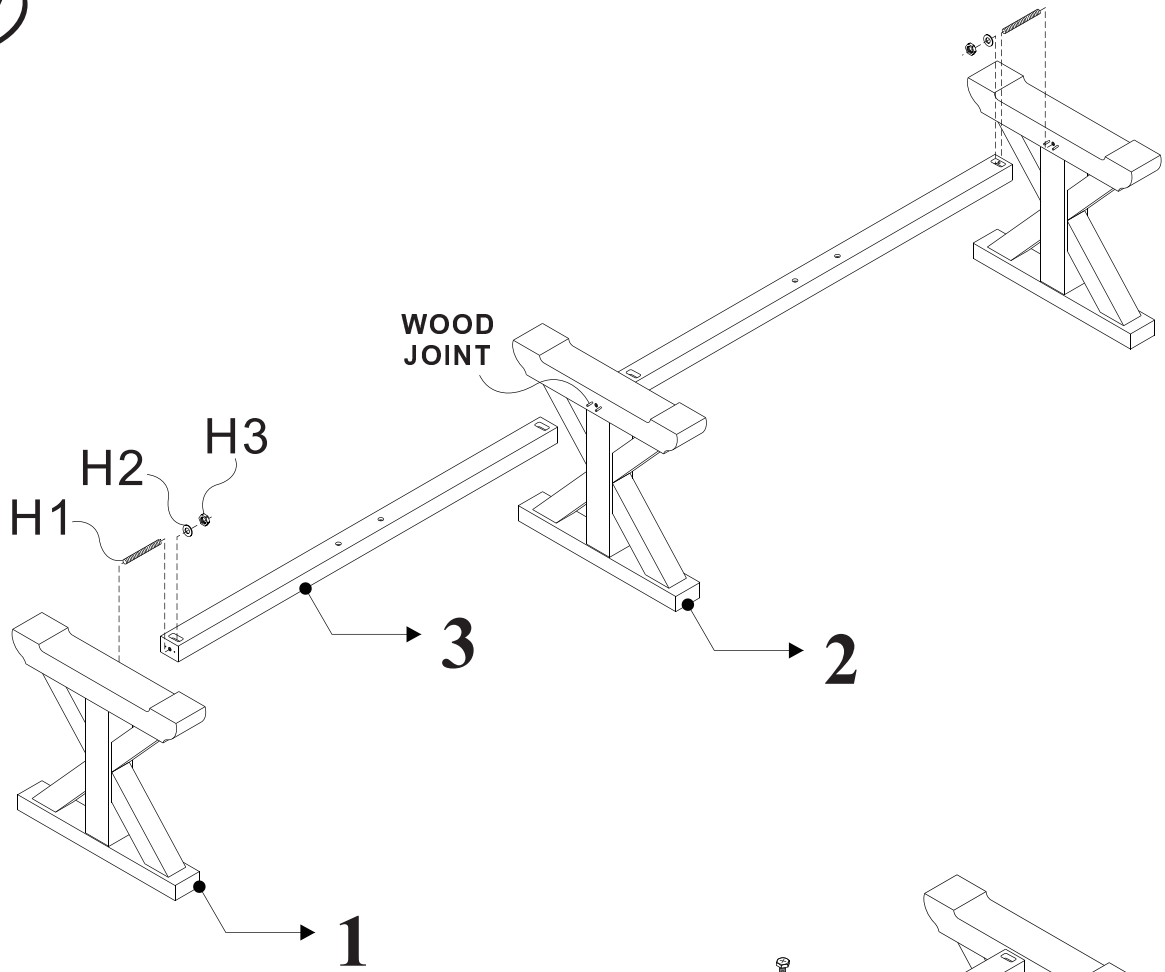

FIG. 2

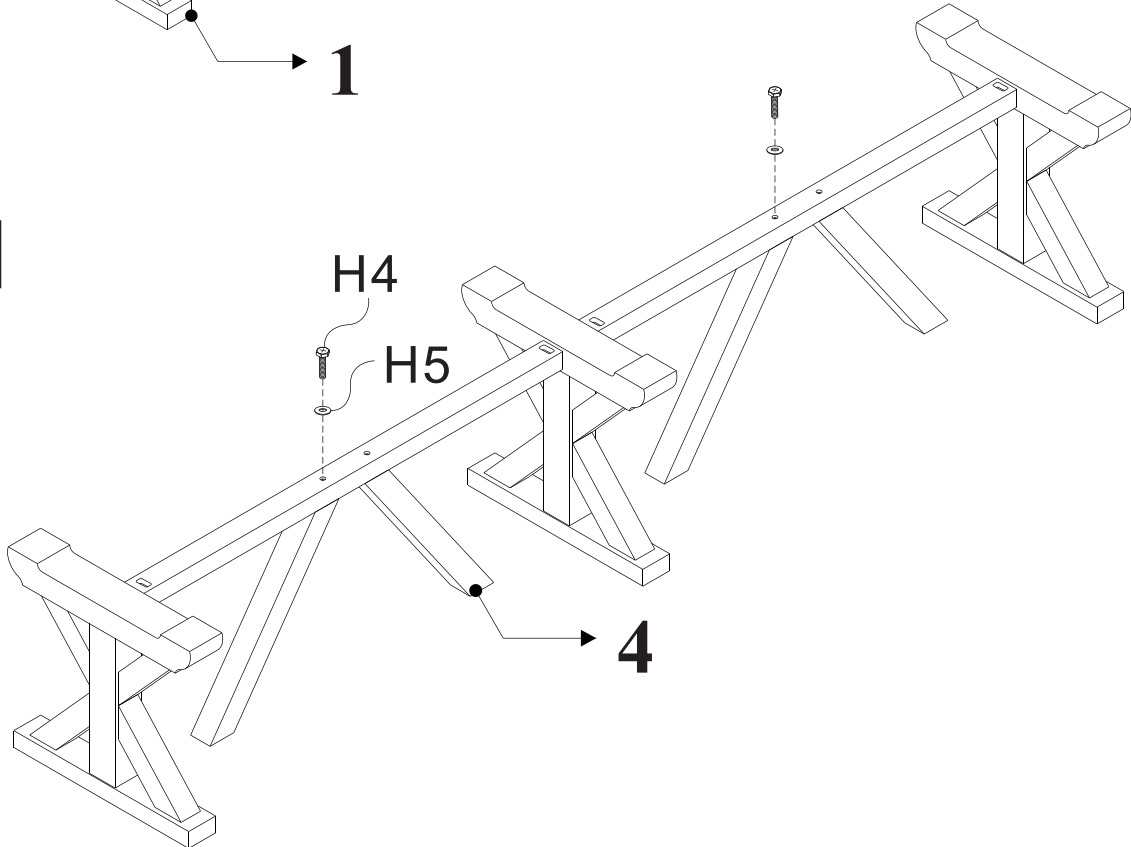



FIG.3

CAUTION: Carefully turn over the leg support assembly using three or more people being certain that each leg is supported and turned at the same time.

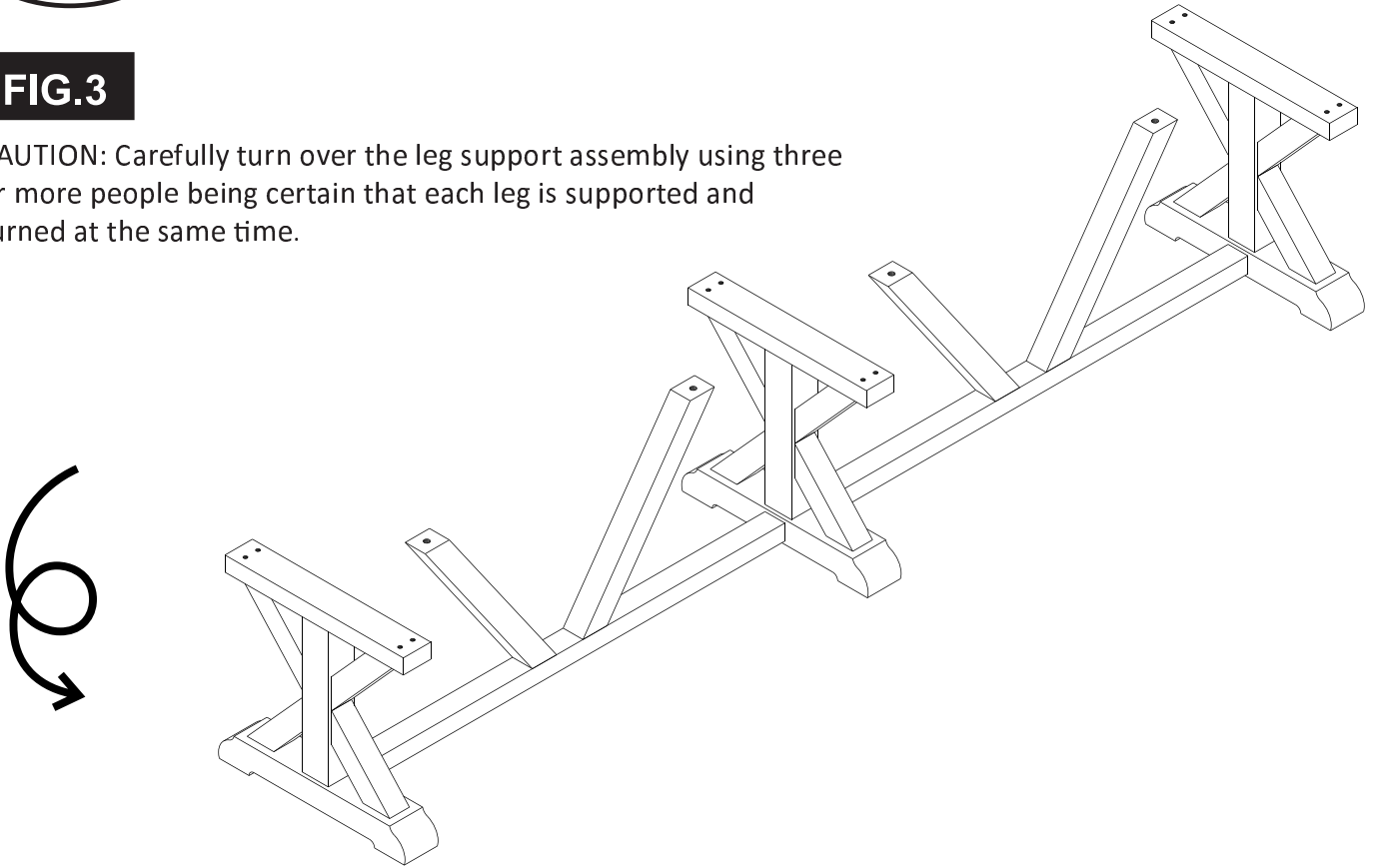

FIG.4

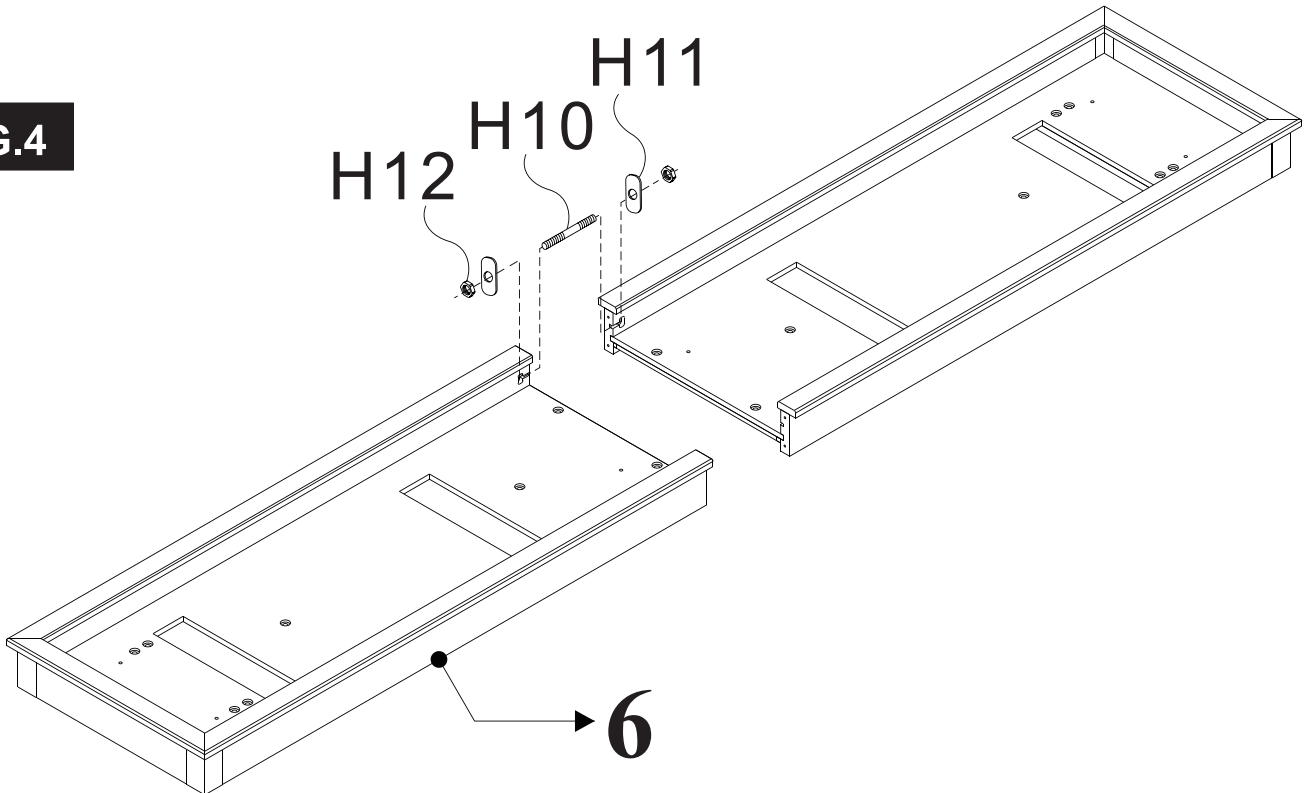

FIG.5

CAUTION: Three or more people are recommended for following steps

1. Carefully move the leg support assembly to the location where the table will be played.
2. Place the cradle on the leg support assembly being certain the center is properly supported while being lifted.
3. Level the cradle placing shims between the cradle and the support assembly as needed.
4. Tighten bolts H6 securing the cradle to the support assembly.
5. Tighten bolts H8

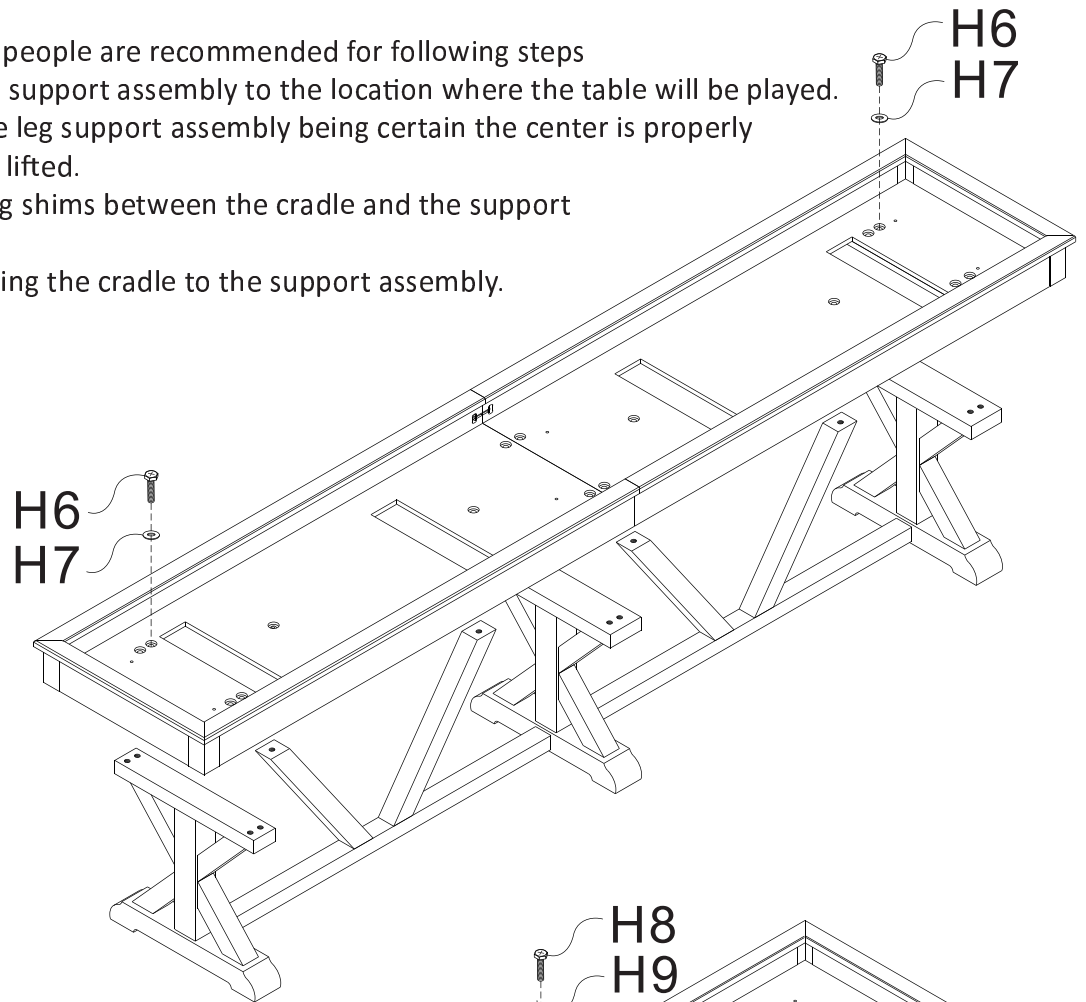
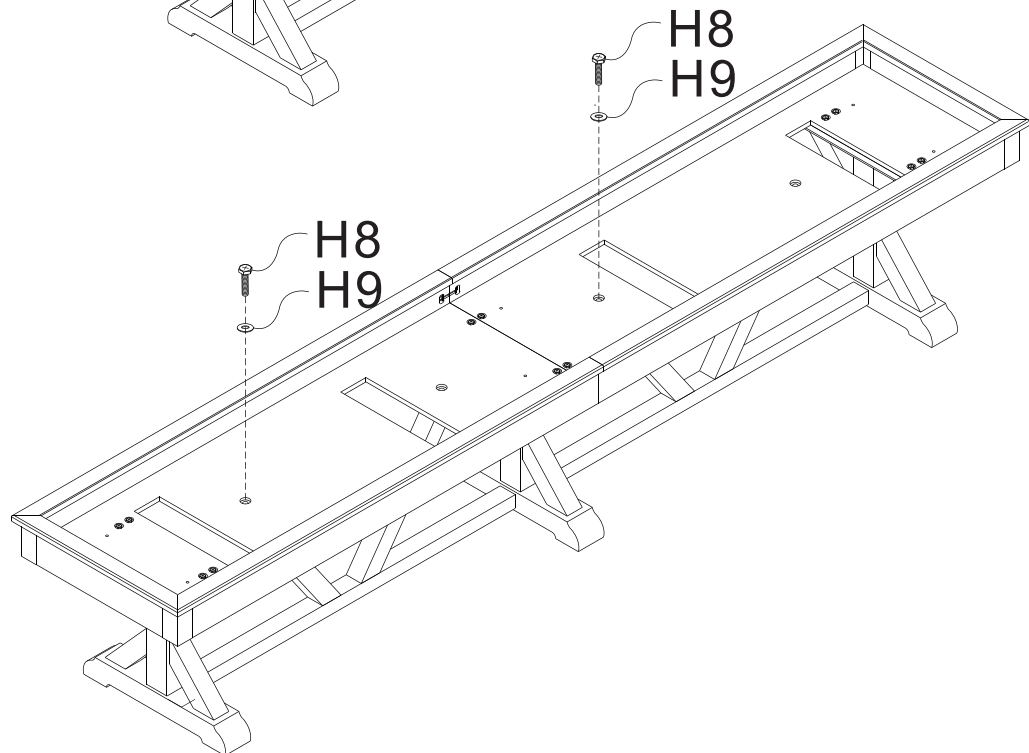

FIG.6





CAUTION: Three or more people are recommended for following steps

1. Be certain the cradle assembly is in the final location where the table will be played
2. Turn the playfield onto a long side or face down onto a soft, smooth surface that will not damage the polymer coating
3. Attach the climate adjusters to the underside of the playfield where the predrilled holes are located.
4. Place shims on the floor of the cradle that will be used to elevate the playfield allowing safer placement of the playfield into the cradle. Thick blocks of wood or the playing weights can be used.
5. Carefully place the playfield onto the shims taking care that the climate adjusters don't hit and damage the cradle. The climate adjuster should drop into the cut outs in the cradle floor.
6. Once placed on the shims center the playfield in the cradle.
7. From underneath the table laying on your back, use your hands to push up on the climate adjusters so that the shims can be removed by another person allowing the playfield to then be lowered onto the cradle floor

FIG.7

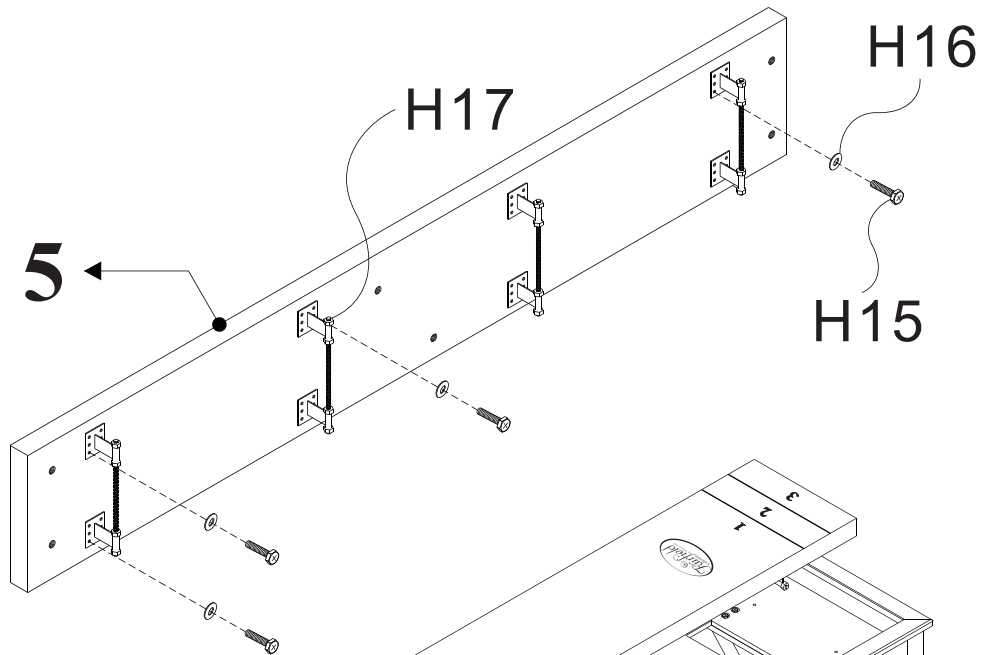

FIG.8

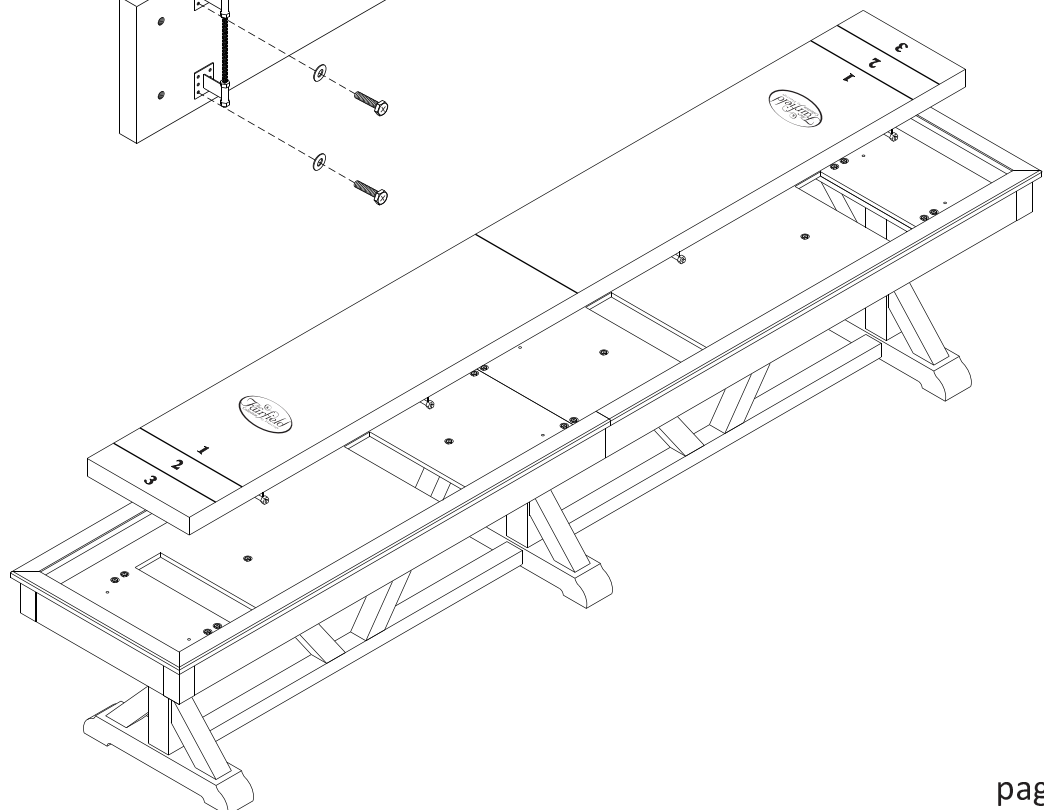
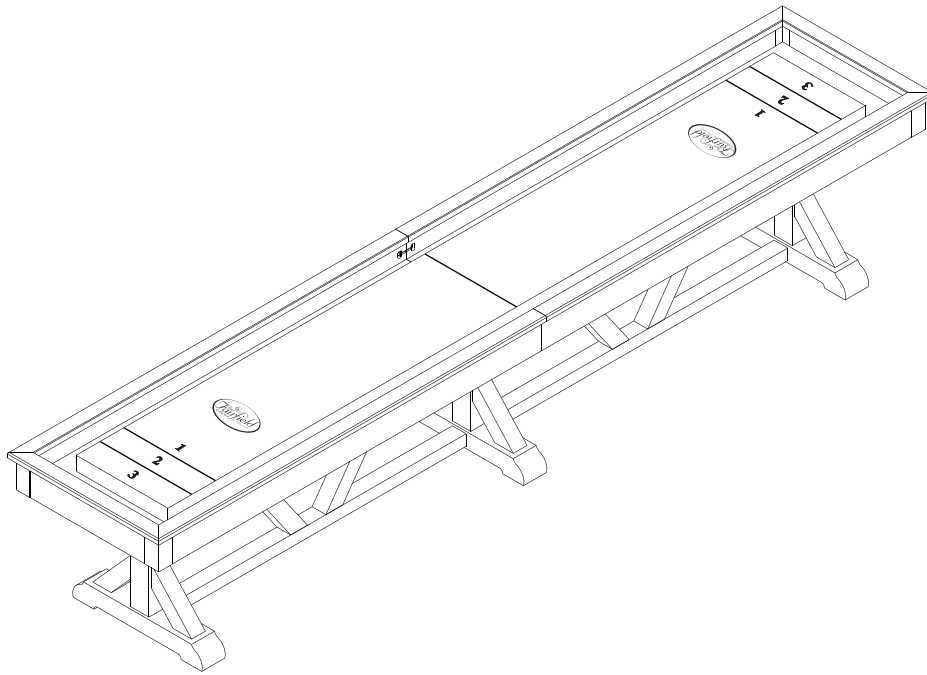



FIG. 9



The assembly of your Playcraft Brazos River pro-series shuffleboard table is complete and the table is almost ready to be played. Some settling may have occurred since the cradle leveling process shown in FIG 5. Additional settling may occur which is normal. The cradle needs additional time to adjust to the weight of the playfield and the table needs time to acclimate to the climate of the room.



ADJUSTING THE SHAPE OF YOUR PLAYFIELD

Your Playcraft shuffleboard is equipped with climatic adjusters used to make level or adjust the shape of the butcherblock playfield. The shape of the playfield will vary between, flat, concave and convex. Climatic conditions in the room where the table is placed will vary between humid or dry which can have an affect on wood over time. Adjustments to the the playfield may be required to maintain an optimal shape, which is flat to slightly concave.

Begin the adjustment process by determining the shape of the playfield. Place a straight edge across the playfield directly above the first climatic adjuster. In order to properly identify the shape the straight edge should be long enough to extend over each edge of the playfield. **IMPORTANT:** Immediate results may not be achieved when reshaping the playfield. Do not attempt to make significant adjustments at one time. It may take several days for your board to fully adjust to the changes made. After the waiting period make additional adjustments as necessary.

If the playfield is **CONVEX** the bottom of the straight edge will touch the surface of the playfield near the center causing the straight edge to rock left to right. Following is an illustration of a convex playfield and direction to adjust to concave. Start by loosening the two outside nuts on the threaded rod. Next, hand tighten the inside nuts so they touch the climatic adjusters as shown. Using a wrench, tighten each inside nut 1/4 - 3/4 turn at a time. This will apply outward force to the adjusters and cause the playfield edges to move in an upward direction. As adjustments are made, test the shape using a piece of paper. Starting with the corner it should be able to slide under the center of the straight edge for approximately 3". If additional adjustments are needed, allow the board several days to a week to adjust to its new shape before additional adjustments are made. Follow the above steps for each climatic adjuster.

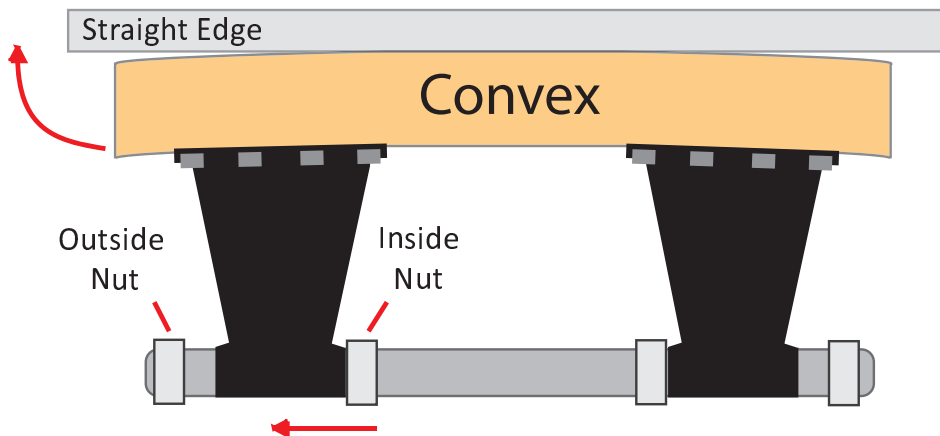

If the playfield is **CONCAVE** the bottom of the straight edge will be touching each edge of the playfield surface but not in the center. This should allow for the corner of a piece of paper to slide under the center of straight edge for approximately 3". If the playfield has an excessive concave shape, adjustments opposite the above for convex should be made as shown below.

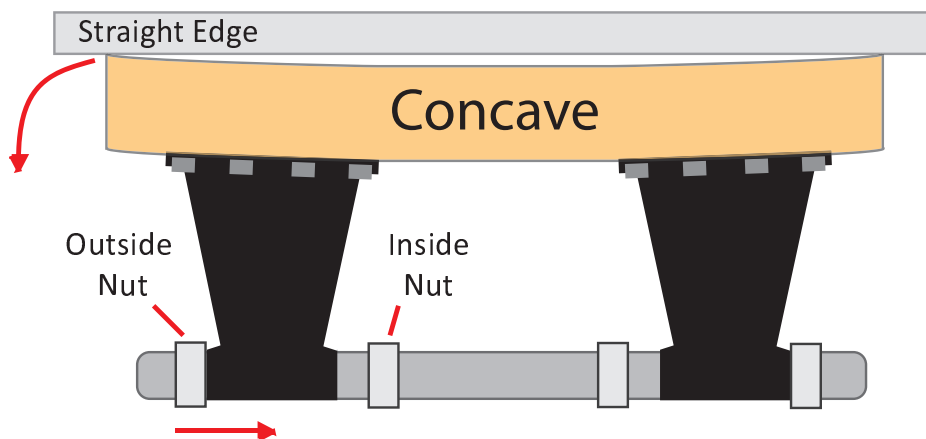



Preparing the playfield

Your Playcraft shuffleboard table includes a butcher block playfield with a thick, polymer coating. The playfield can be cleaned using Playcraft Cleaner Polisher applied to a soft cloth. Alternately use a mild multi-purpose cleaner or glass cleaner applied modestly to a soft cloth. Sponges or abrasive cleaners should not be used as they could scratch the polymer finish.

Applying the speed wax

Included with your table is a can of granular speed wax that is optimal for the length of the table. Prior to applying the speed wax a coating of Playcraft Spray Silicone should be applied to the playfield. Once coated do not wipe the silicone. The silicone holds the speed wax in place for an extended period of time. A sufficient coating of speed wax should now be applied to the playfield. To apply the wax simply shake onto the playfield so a moderate coating is established over the entire surface. Glide a weight to test the application. If a weight slid under reasonable force stops at any point on the playfield then that spot or the entire surface requires additional wax. Reapply the granular speed wax as necessary.

How to play shuffleboard - basic rules

How To Play With 2 Players

To start a game, both players stand at the same end of the shuffleboard. Players toss a coin or otherwise choose who shall shoot the first weight, and what color weights each shall have (it is an advantage to shoot last).

The first player slides his/her first weight toward the opposite end of the board, which becomes the scoring end. His/Her opponent then shoots his/her first weight in a similar manner, attempting either to knock off the other player's first weight, or to outdistance it. The two players continue shooting their weights alternately, until all eight Weights have been shuffled. When this has been done, one round of play has been completed. The player who's leading weight is furthest down the board (away from the players) is the winner of the round. The winner's score is then totaled and registered on the scoreboard.

The players then proceed to the opposite end of the shuffleboard, where the weights are now resting. Another round of play is begun in exactly the same manner as described above, from this end of the board, with the winner of the previous round shooting first weight. The game continues for as many rounds as are necessary, until one player has scored 15 or 21 points to win the game.

How To Play With 4 Players

When four players compete, they play as doubles teams of two players each. One player from each team is stationed at each end of the board, so that two opposing players are at the same end, with their partners at the opposite end. Having decided which team shoots first and which will shoot Red or Blue weights, the play begins as in a two-player game – the first player slides his weights toward the opposite end of the board, which becomes the scoring end. The opponent at his side then shoots his first Weight in a similar manner. The two players continue shooting their weights alternately, until all eight weights have been shuffled. At this point, one round of play has been completed.

The players at the opposite end of the board, where the weights are now resting, clear the board and begin another round of play from their end, in exactly the same manner and with the partner of the previous round's winner shooting the first weight. The players continue as many rounds as necessary, until one team has scored a total of 15 points in knock off typically (or some still play to 21 points).



Customer Service

For questions on assembly or for missing or damaged parts, please contact us toll free at (888) 367-3095 or via email at support@playcraft.com. Please visit our website at www.playcraft.com to see more industry leading Playcraft and Playcraft Sport game tables.

Thank you for choosing Playcraft!

Global Merchants, Inc.
12 Lunar Drive
Woodbridge, CT 06525