

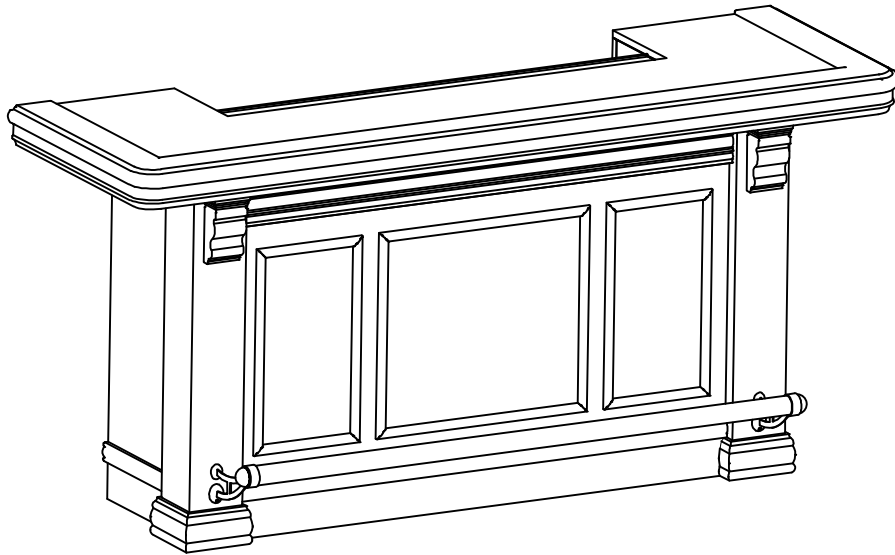











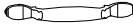

**AHB**

HOME FURNITURE COLLECTIONS

**ASSEMBLY INSTRUCTION****ARABELLA BAR**

	HARDWARE LIST	QTY	OUTLOOK
A	FOOT RAIL HEX BOLT (5/16" * 2-1/2")	2	
B	FOOT RAIL FLAT WASHER (5/16" * 19 M/M)	2	
C	FOOT RAIL SCREW (φ5 * 8MM)	2	
D	FOOT RAIL P. H SCREW (φ4 * 25MM)	2	
E	ANCHOR	2	
F	FOOT RAIL	1	
G	FOOT RAIL COVER	2	
H	BLOCK	2	
I	DOOR HANDLE	4	
J	DOOR HANDLE SCREW (5/32" * 1-1/2")	4	
K	DOOR HANDLE SCREW (5/32" * 1")	4	
L	FOOT RAIL P. H SCREW (φ4 * 32MM)	10	
M	KEY	4	
N	CUP HOLDER	4	

# A H B

HOME FURNITURE COLLECTIONS

## ASSEMBLY INSTRUCTION

### ARABELLA BAR

#### STEP 1

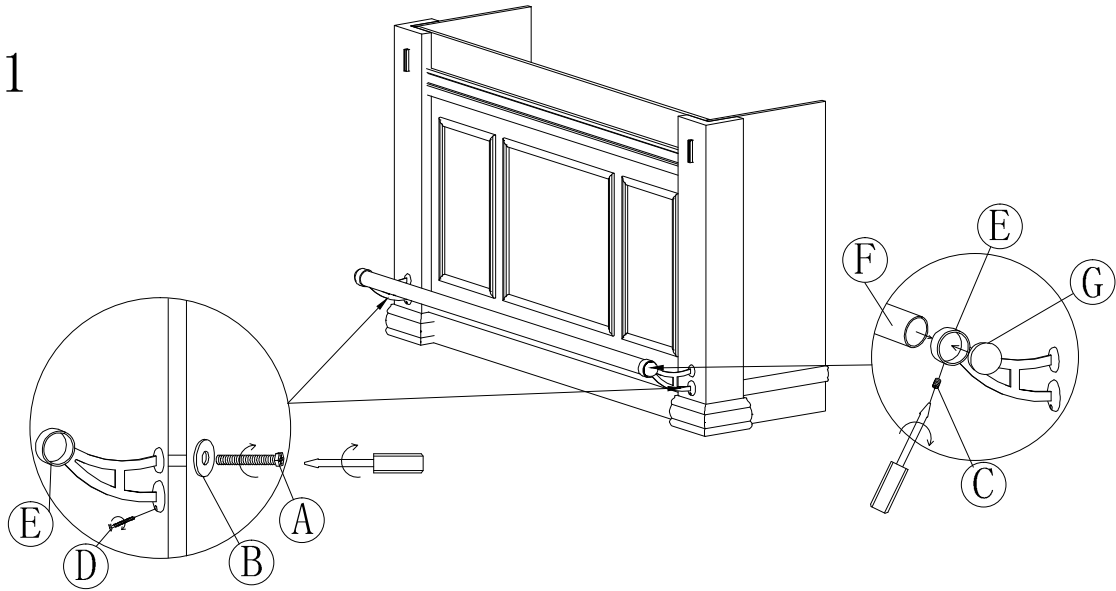

#### STEP 2

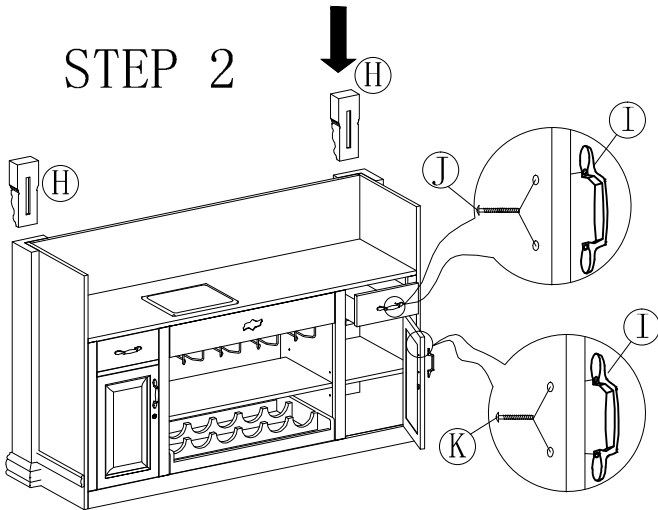

#### STEP 3

