

KETTLER®

Competition 3.0
7132-155

Adult Assembly Required

Made in Germany



Picture Similar

KETTLER® International, Inc. ● 1355 London Bridge Road ● Virginia Beach, VA 23453 USA
www.kettlerusa.com
info@kettlerusa.com

Please do not return this product to the store. Contact KETTLER® for parts and service: call toll free 866.804.0440 or send email to parts@kettlerusa.com.



Please visit our website www.kettlerusa.com to view a video demonstration of product assembly or scan the QR Code above.



Tools needed; not included



Before Assembly

Before assembling or using the table tennis table, please read the following instructions carefully. They contain important information for use and maintenance of the equipment as well as for your personal safety. Keep these instructions in a safe place for maintenance purposes or for ordering spare parts.

All KETTLER® products are designed in accordance with the latest safety regulations and undergo a constant process of quality control during manufacturing. The knowledge gained in this process is used to constantly improve and develop our products. In order to offer our customers the very best in product quality, we reserve the right to make technical changes at any time. In spite of this, should you have any cause for complaint, please contact KETTLER®.

Note on Safety

- The table tennis table should be used only for its intended purpose, i.e. for playing with suitable table tennis racquets and balls.
- All other uses are prohibited and may be dangerous. The manufacturer cannot be held liable for damage or injury caused by improper use of the table.
- Damage or worn components may endanger your safety or shorten the lifespan of the table tennis table. Replace worn or damaged components immediately and remove the table from use until this has been done. Use only spare parts manufactured by KETTLER®.
- The table tennis table complies with all safety regulations. Incorrect repairs, alterations to the design (removal of original parts, addition of other components etc.) may endanger the safety of the user.
- Instruct other persons (in particular children) using the table in its correct use, and draw their attention to any potential source of danger, especially when setting up or dismantling the table.
- Caution: During assembly, keep all items out of children's reach (choking hazard – contains small parts).
- When setting up or dismantling the table, stay clear of its folding radius.
- When folded up, the table tennis table presents a large surface to the wind. For this reason, ensure that it is stored in a sheltered position.
- The table tennis table may be pushed only in the transport position otherwise there is a risk of injury.
- The unit complies with the standard EN 4468-1:2004.
- Regularly check all screws, bolts, etc. to ensure they are in good condition.
- Warning: Children should not attempt to fold/unfold table. May result in injury

Handling the Equipment

- Do not use the table tennis table until it has been fully and correctly assembled and checked.
- Ensure that indoor table tennis tables are not exposed to dampness or rain. Keep them well away from direct sources of heat. Should the surface become warped, lay the table on a level surface for a few days.
- Set the table up on a level surface.
- Do not cover it with a tarp, which can result in condensation forming. We recommend the weatherproof KETTLER® cover, part number 7032-900. Cover should only be used when table is in folded position.
- For practicing without a partner, the table halves can be folded up individually.
- Do not use corrosive or abrasive materials to clean the equipment. Ensure that such materials are not allowed to pollute the environment. In most cases, a slightly dampened cloth is sufficient.
- Waste Disposal: KETTLER® products are recyclable. At the end of its useful life, please dispose of correctly and safely complying with your local facilities and guidelines.
- Store table in folded position when not in use.

Before Assembly (continued)

General Assembly Instructions

- The equipment must be assembled with care by two adults.
- Separate all the parts including the hardware. Compare quantities with the package contents section and that all items are undamaged. If there are any problems, please contact KETTLER®.
- Before assembling the equipment, study the drawings and photos carefully then assemble in the order shown.
- Please note that there is always a danger of injury when working with tools or doing manual work. Therefore, please be careful during assembly.
- Ensure that your working area is free of possible sources of danger, for example don't leave any tools lying around. Always dispose of packaging material in such a way that it may not cause any danger. There is always a risk of suffocation if children play with plastic bags!
- The fastening items required for each assembly step are shown at the beginning of the step. Use the fastening items exactly as instructed.
- Bolt all the parts together loosely at first, and check that they have been assembled correctly. Then use spanner for final tightening. Then check that all screw connections have been tightened firmly.
- For technical reasons, we reserve the right to carry out preliminary assembly work (e.g. addition of tubing plugs).
- Please keep original packaging, so that it may be used for transport at a later date, if necessary. Goods may only be returned after prior arrangement and in packaging that is safe for transportation (in the original box if possible). It is important to provide a detailed defect description/damage report.

Package Contents



Number Included - 2



Number Incl - 4 locking



Number Incl - 4 non locking



Number Included - 2

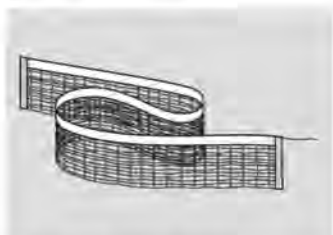

Number Included - 1



Number Included - 2



Number Included - 2



Number Included - 2



Number Included - 2



Number Included - 3

Package Contents (continued)



Number Included - 4



Number Included - 2



Number Included - 2



Number Included - 4



Number Included - 2



Number Included - 2

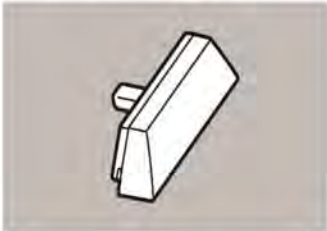

Number Included - 2

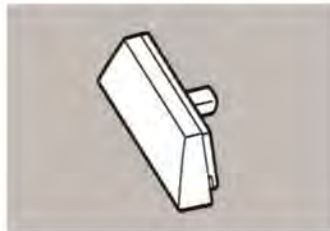

Number Included - 2

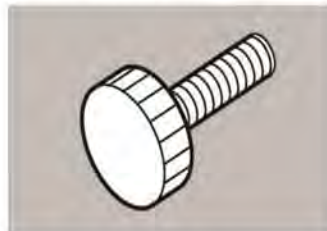

Number Included - 2

Items below are shown at actual size

Number Included - 2



Number Included - 4
m8x110



Number Included - 4
m6x65



Number Included - 6
m8x60



Number Included - 4
m6x20



Number Included - 2
m6x16



Number Included - 8
3.9x16

Package Contents (continued)

Items below are shown at actual size



Number Incl – 4
m8



Number Incl – 4
m6



Number Incl – 4
m6



Number Incl – 2



Number Incl – 6
dia 25x8



Number Incl – 16
dia 16x8



Number Incl – 8
dia 12x6



Number Incl – 2
"1"



Number Incl – 2
"2"



End view and side view shown
Number Incl – 4
m12x6x15



Number Incl – 4



Number Incl – 8
m12x6x3



Number Incl – 2



Number Incl – 2



Number Incl – 4
m6 locking



Number Incl – 4

Tools Included
(not shown at actual size)



Assembly

Step 1 a

Insert drift pin. There are two footlocks and stemtubes. Assemble both as shown.

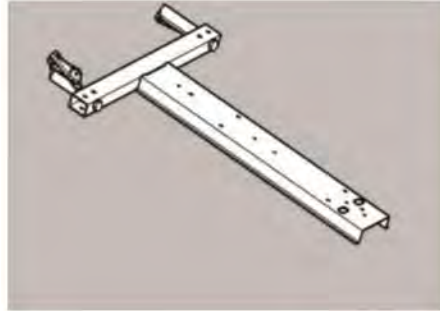

2 Required



2 Required



A



B

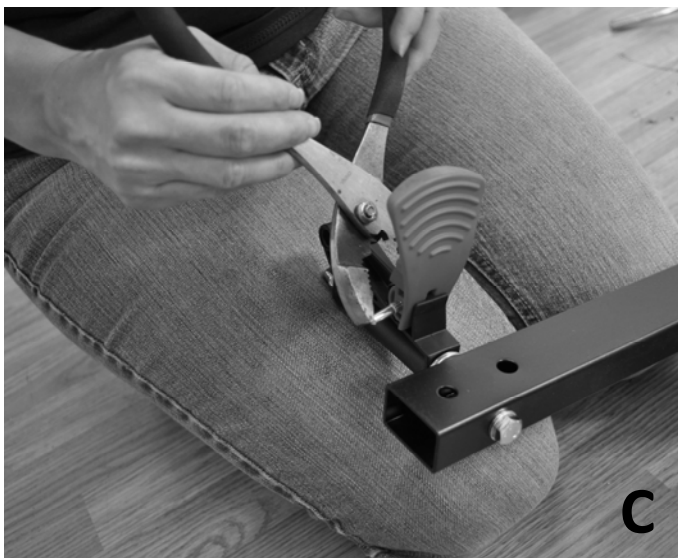

C



D

Assembly

Step 2



Install locking wheels.
The grooves of the wheels should face inward.
Do not over torque; wheels should roll smoothly.
Push down foot lock to lock the wheels. Install locking wheels on both wheelbase assemblies.



2 Required
m8x110



2 Required
m8



8 Required
dia 16x8



A



B



C



D

Assembly

Step 2 continued



Repeat steps with non locking wheels.

Assembly

Step 3

Install H-Pad to Flange (A-C).
Install crossbar between wheelbase assemblies.
Take note of wheelbase assembly positions.
The assembly thus far should match photo I.



4 Required



2 Required
m8x60



2 Required
dia 25x8

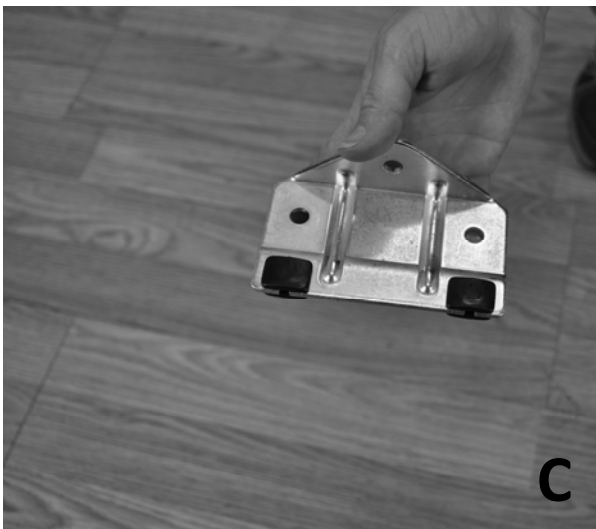

Assembly

Step 3 Continued

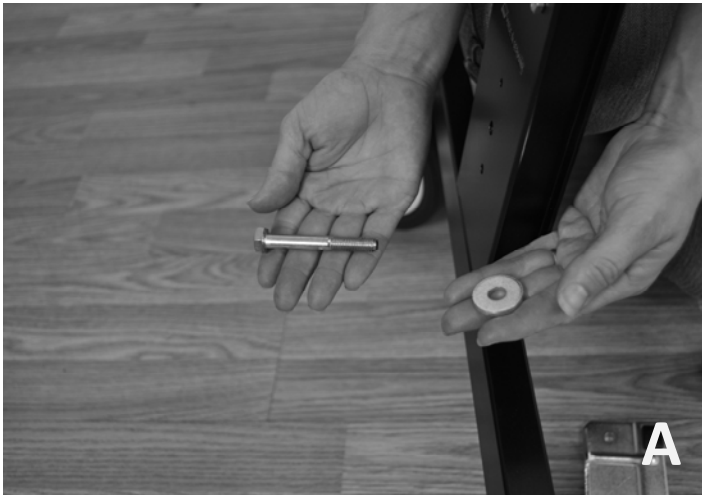

Assembly

Step 4

Slide crossbar through eyelet in J-bar. Repeat on both sides.

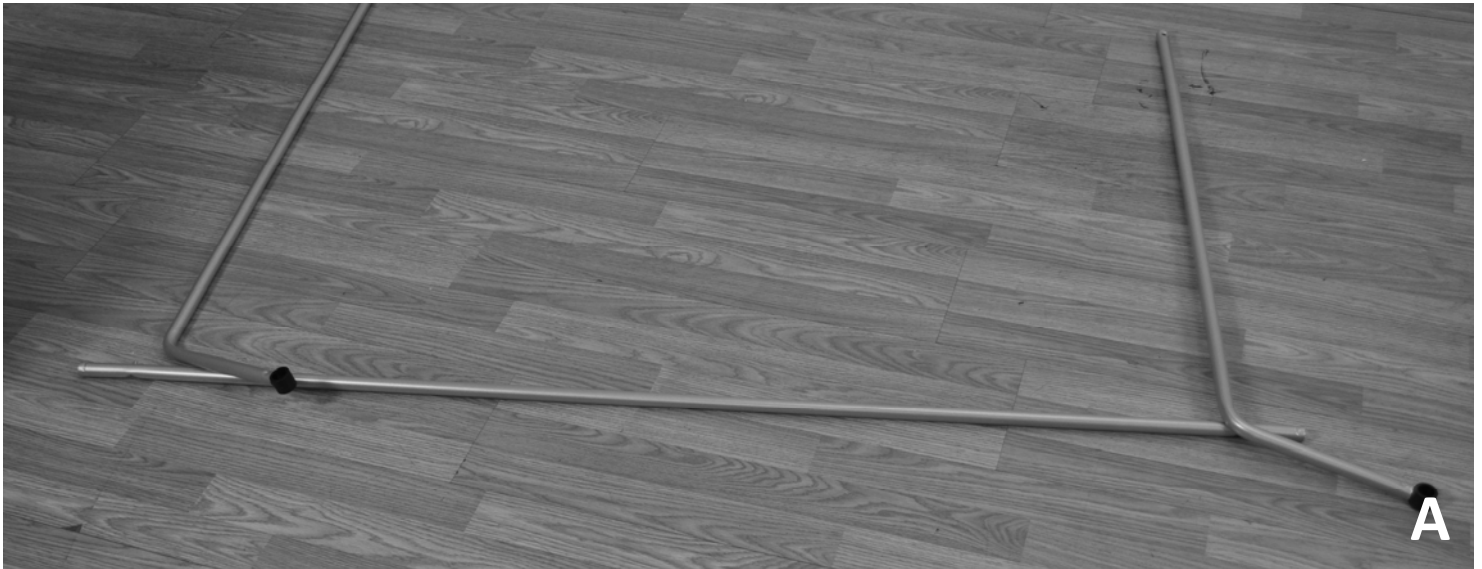

Assembly

Step 5

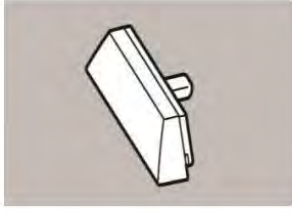
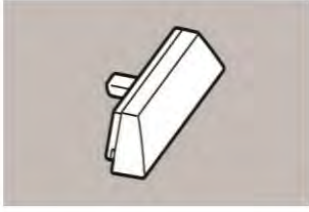

4 Required
dia 12x6



4 Required
m6 locking



4 Required

Attach Glides to tops as shown.
Note the position of the Glide to the corresponding
table side.



A

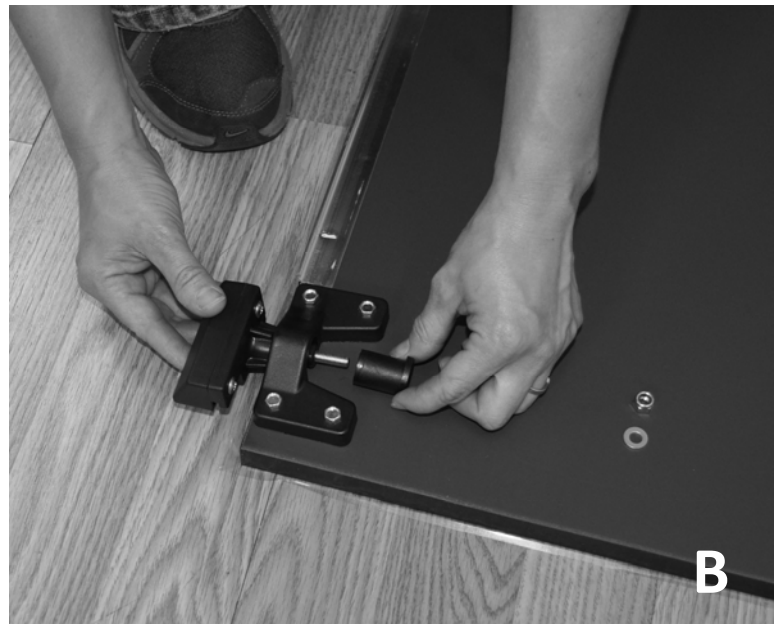

B



C



D

Assembly

Step 5 continued

Repeat on other side.

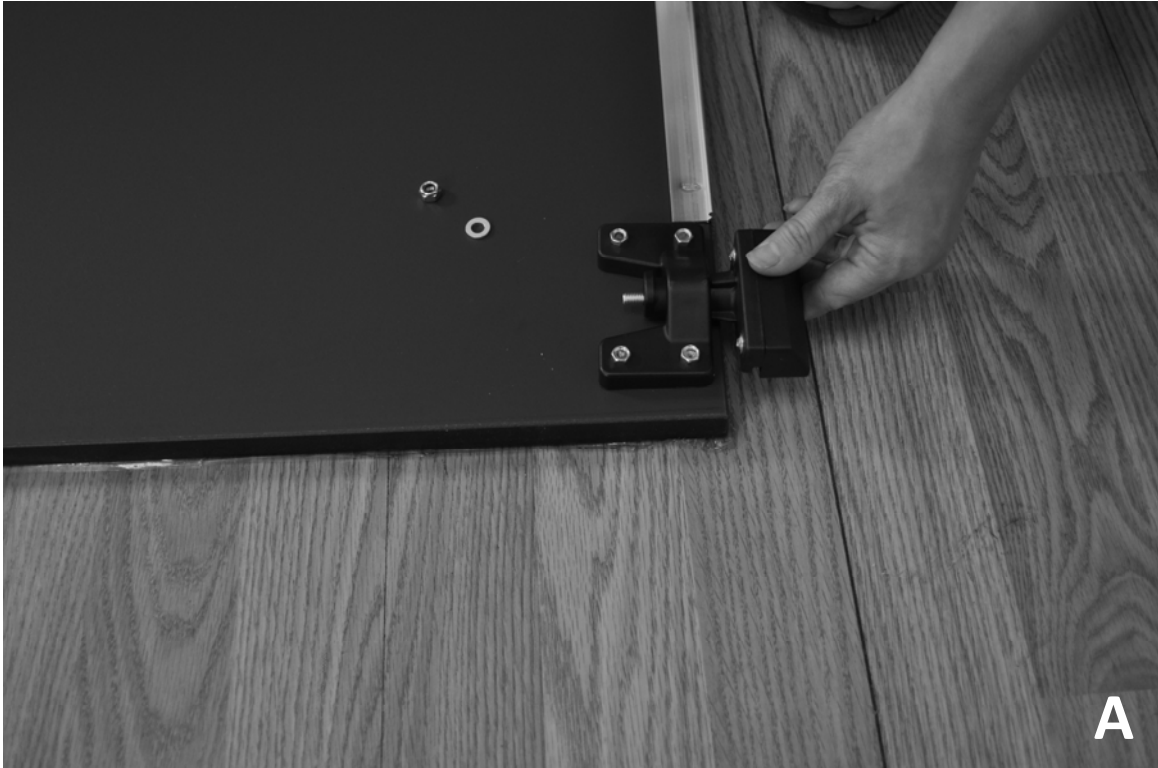

Assembly

Step 6 a

Attach J-bar to legs

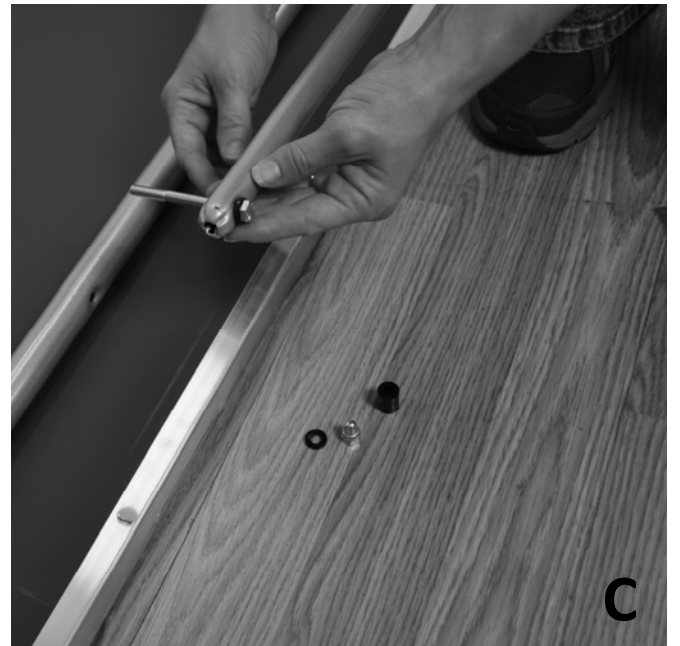
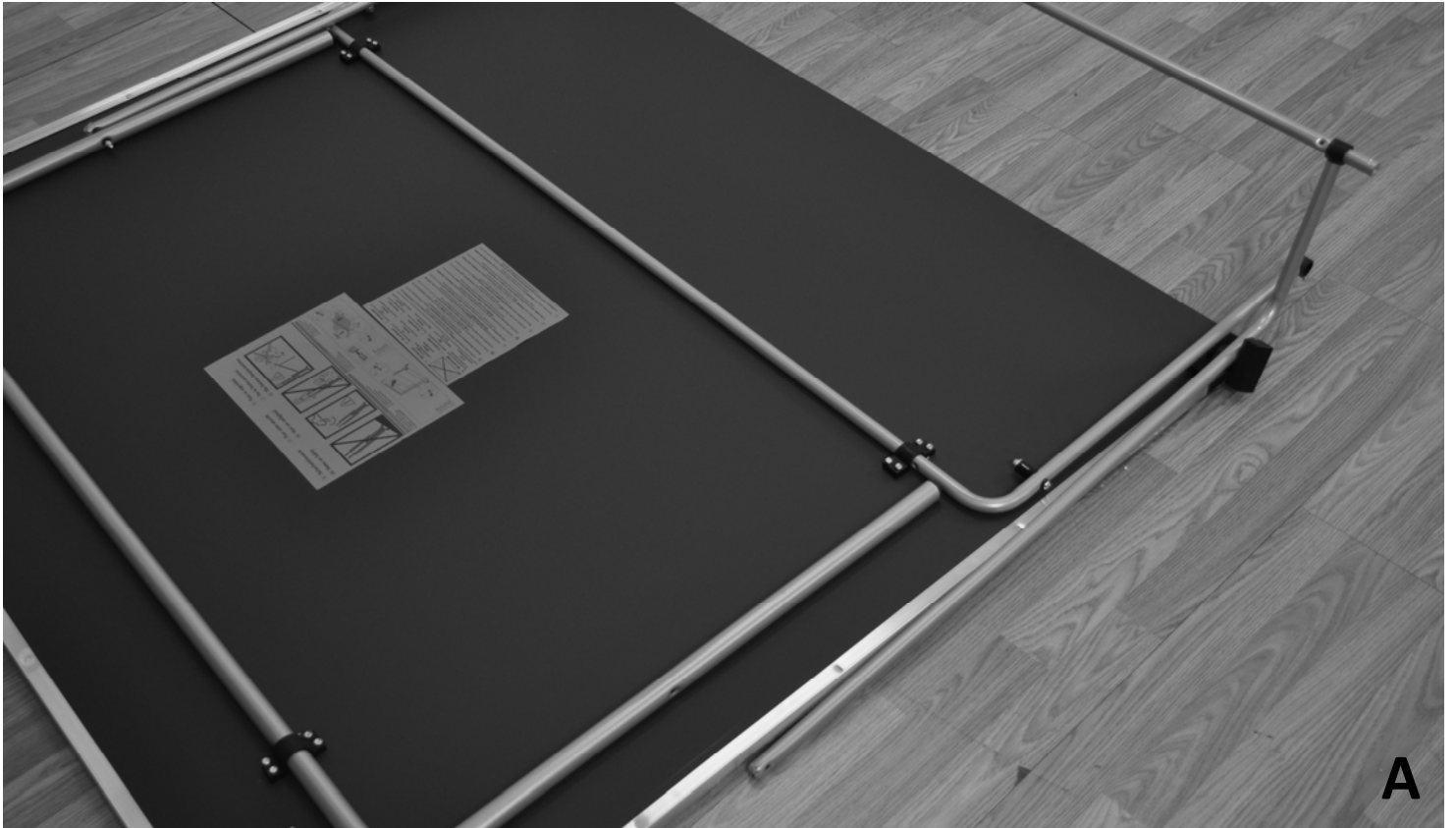

Assembly

Step 6 a continued

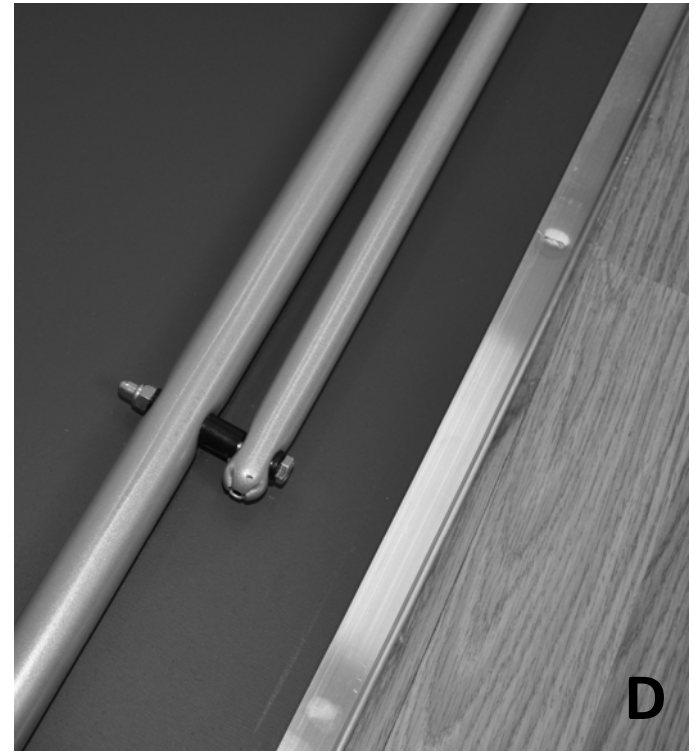
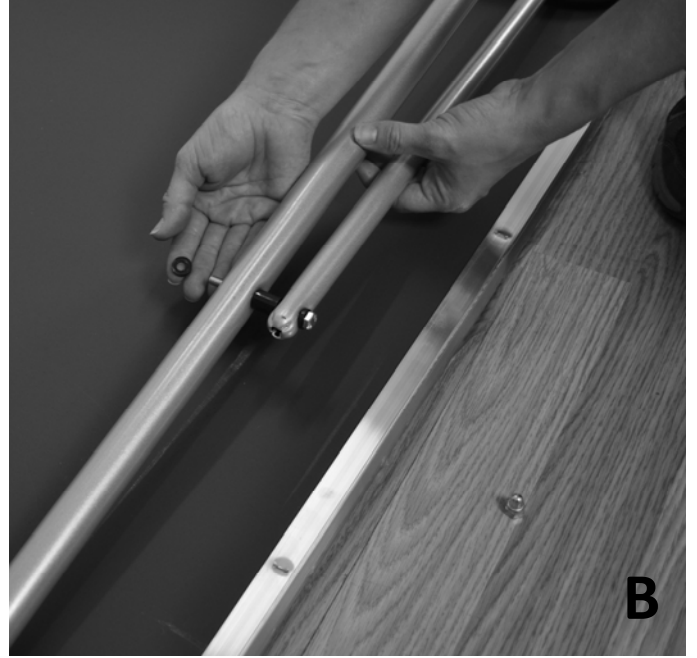
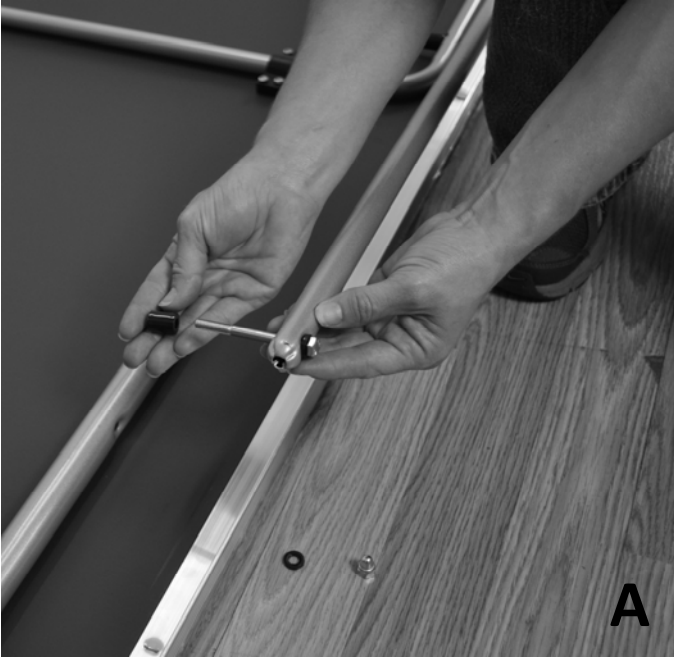

Assembly

Step 6 b

Insert black plastic ring onto crossbar.
Attach crossbar to support leg.



To do this, the braces for the frame must be bent slightly to the side. Proceed with care when doing this.

Assembly

Step 7

Temporarily install safety knobs to wheelbases for the top assembly.
Push in safety knobs.



Assembly

Step 8

Lock safety knob 1 in place (A, B).

Lift table and align the Glides with the Wheelbase (C, D)

On the opposite wheelbase, hold knob 2 in place while lowering top (D).

Release when Glide passes knob assembly.



Assembly

Step 9

Bolt Crossbar to Wheelbase as shown.



2 Required
m8x60



2 Required
dia 25x8



A



B



C



D

Assembly

Step 10

Repeat steps 8 and 9.

Step 11

Slightly fold open table,
Caution, use two people.



One table half shown for illustrative purposes only.
Your table should have both halves assembled at this point.

Assembly

Step 12

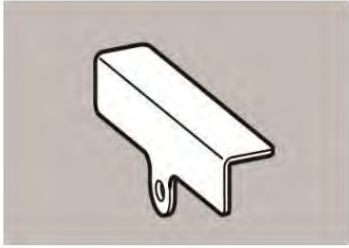

Assemble net post panel and flange as shown.

Take out safety knob for net assembly.



4 Required
m6



4 Required
m6x20



4 Required
dia 12x6



Assembly

Step 12 continued



Repeat on other side

Assembly

Step 13

Re-attach Safety Knobs and screw into place.



Assembly

Step 14



4 Required

Cover open holes on wheelbase without racquet holder.

Note: An additional racquet and ball holder can be purchased by calling KETTLER Parts and Service Department at 866-804-0440 and requesting part number 7094-999 or visit www.kettlerusa.com.



Assembly

Step 15

Open and close table to check for functionality.



Assembly

Step 16

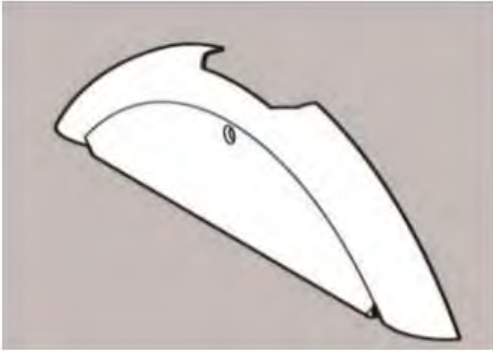

2 Required



4 Required
3.9x25

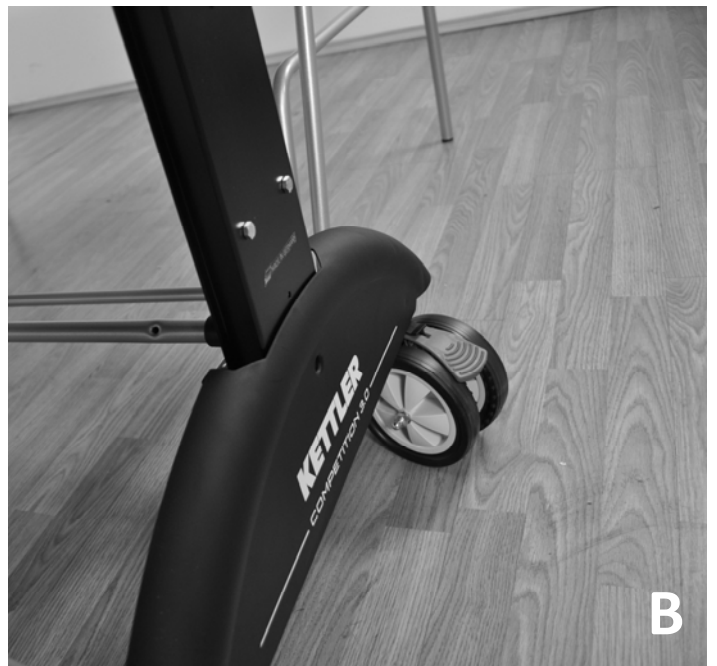
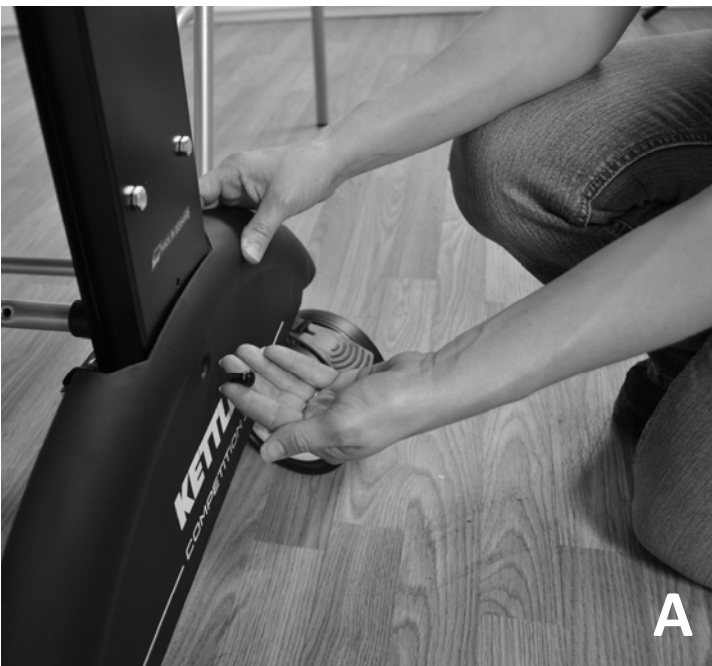

Assembly

Step 16 continued

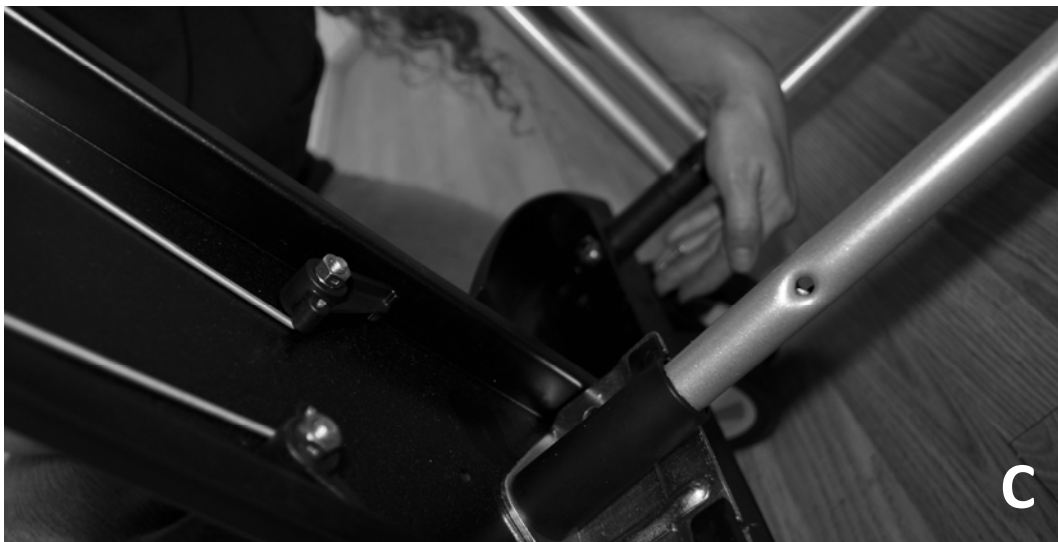

Assembly

Step 18

Thread J-hook through net and place into net post.



Attach tension tab.



D Ersatzteilzeichnung und -liste

GB Spare parts drawing and list

F Dessin et liste des pièces de rechange

NL Reserveonderdeeltkening en -lijst

E Designación y lista de las piezas de recambio

I Disegno ed elenco dei pezzi di ricambio

PL Rysunek i lista części zamiennych

RUS Схема и перечень запасных частей

07172-250

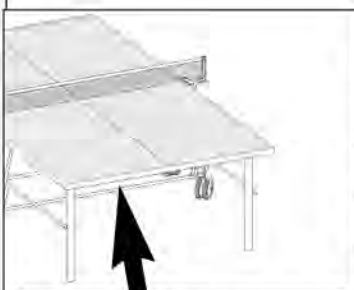
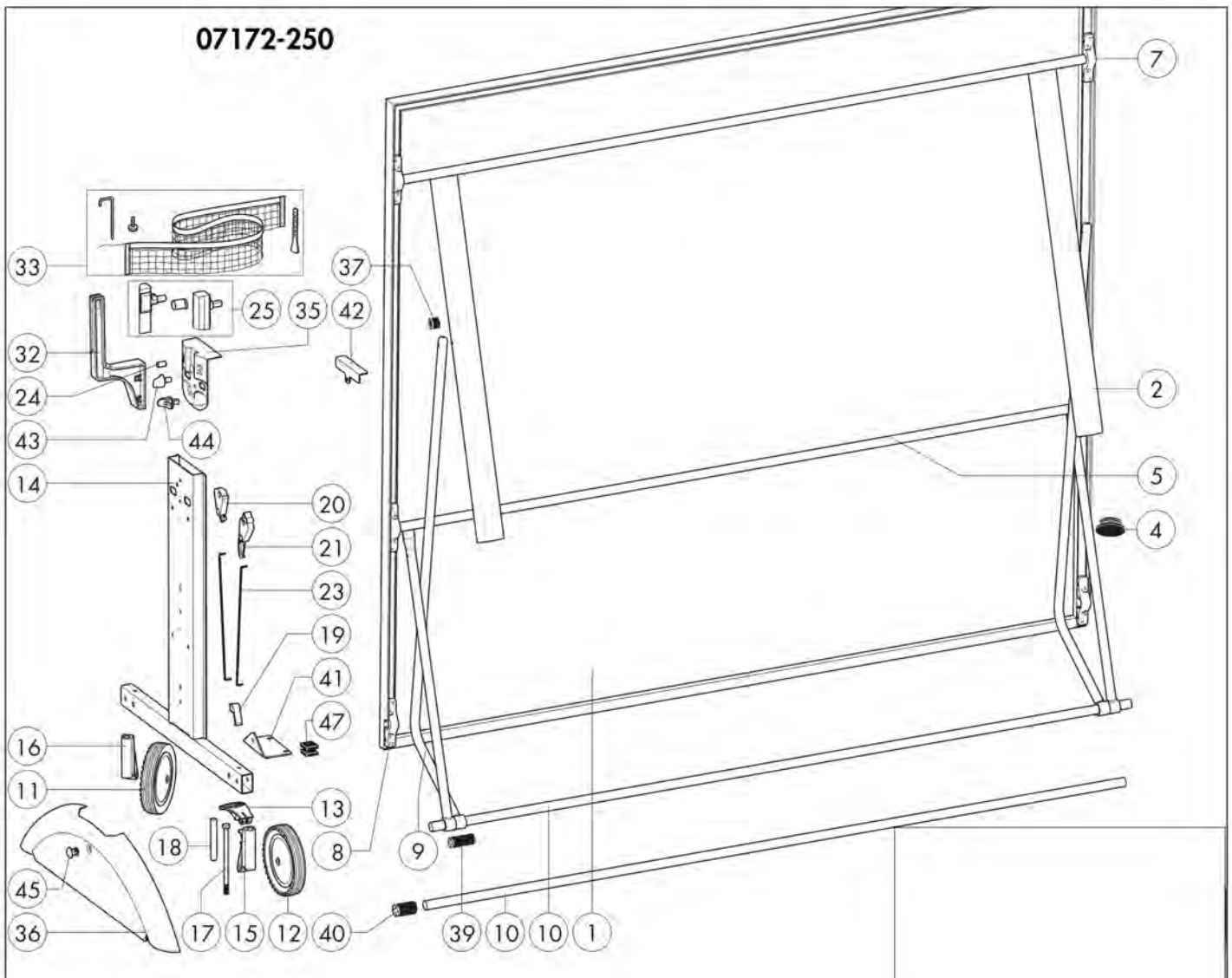

- D Typenschild – Seriennummer
- GB Type label – Serial number
- F Plaque signalétique – Numéro de serie
- NL Typeplaatje – Seriennummer
- E Placa identificativa – Número de serie
- I Targhetta tecnica – Numero di serie
- PL Tabliczka identyfikacyjna – Numer serii

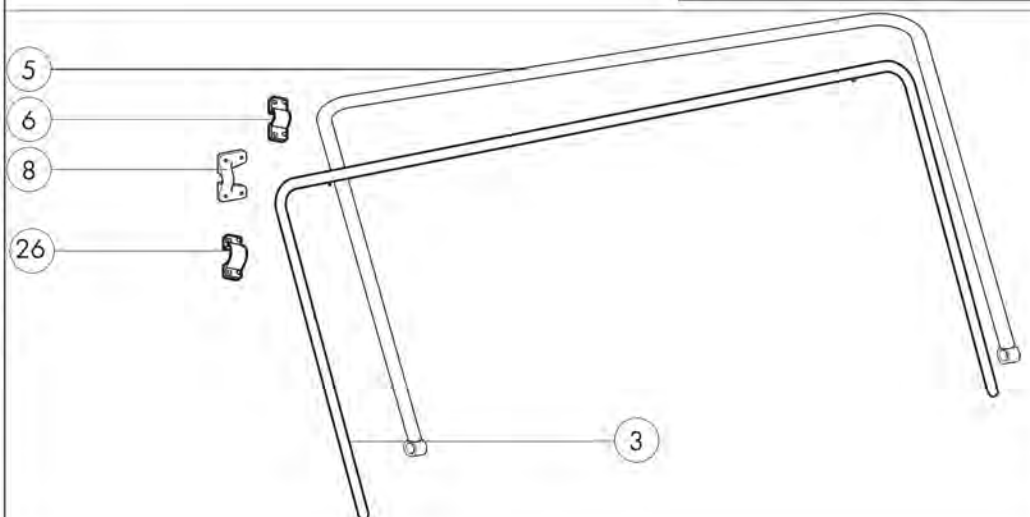

D Ersatzteilliste

- GB** Spare parts drawing and list
PLEASE ALWAYS QUOTE THE TT TABLE ARTICLE NUMBER AS WELL.
- F** Dessin et liste des pièces de rechange
VEUILLEZ ABSOLUMENT INDIQUER LE NUMÉRO D'ARTICLE DE LA TABLE DE PING-PONG!
- NL** Reserveonderdeeltkening en -lijst
IN IEDER GEVAL A.U.B. HET ARTIKELNUMMER VAN DE TT-TAFEL VERMELDEN.

- E** Designación y lista de las piezas de recambio
ES NECESARIO INTRODUCIR EL NÚMERO DE ARTÍCULO DE LA MESA DE PING-PONG.
- I** Disegno ed elenco dei pezzi di ricambio
È ASSOLUTAMENTE NECESSARIO INDICARE ANCHE IL CODICE DI ARTICOLO DEL TAVOLO DA PING-PONG!
- PL** Rysunek i lista części zamiennych
PROSZĘ KONIECZNIE PODAĆ NR ARTYKUŁU STOŁU DO TENISA STOŁOWEGO
- RUS** Схема и перечень запасных частей
Плита стола для пинг-понга (ОБЯЗАТЕЛЬНО УКАЗЫВАЙТЕ АРТИКУЛЬНЫЙ НОМЕР СТОЛА ДЛЯ ПИНГ-ПОНГА!)

Teil Nr.	Bezeichnung	Stück	Ersatzteil-Nr.	Ersatzteil-Nr.	Ersatzteil-Nr.
			für 07132-150 COMPETITION	für 07172-250 COMPETITION	für 07172-255 COMPETITION
1	TT-Plattenhälfte	2	94130117	94130125	94130125
2	Fußgestell	2	94111447	—	—
3	Fußbügel	2	—	94111444	94111444
4	Bodenschoner 25mm Durchmesser	4	10100029	10100029	10100029
5	Stützbügel	2	94110855	94110814	94110814
6	Rohrschelle 18mm	4	94110192	—	—
7	Lagerböckchen 18mm	8	—	10128028	10128028
8	Lagerschelle 18mm	4	94110868	70131000	70131000
9	Schubstange	4	94110822	94110822	94110822
10	Verbindungsrohr M8	3	94110712	94110712	94110712
11	TT Rad ohne Bremsnocken	4	40120100	40120100	40120100
12	TT Rad mit Bremsnocken	4	40120099	40120099	40120099
13	Bremshebel	2	70130816	70130816	70130816
14	Seitenteil	2	94111299	94111299	94111299
15	Radverbinder für gebremstes Rad	2	70130847	70130847	70130847
16	Radverbinder	2	70130848	70130848	70130848
17	6-kant Schraube M8x140mm	4	10206086	10206086	10206086
18	Distanzrohr 85mm lang	4	97201441	97201441	97201441
19	Sicherungshebel unten	4	70130826	70130826	70130826
20	Sicherungshebel oben	2	70130827	70130827	70130827
21	Sicherungshebel oben mit Raste	2	70130828	70130828	70130828
22	Zugfeder (o.Abb.)	2	25616011	25616011	25616011
23	Zugdraht	4	25057020	25057020	25057020
24	Distanzrohr 16mm lang	10	97200573	97200573	97200573
25	Gleitstücke Set	1	94111159	94111159	94111159
26	Lagerschelle 25mm	4	94110341	—	—
32	Netzhalter komplett	2	94111269	94111269	94111269
33	Netztüte komplett	1	94180384	94180384	94180384
34	Spannlasche	2	10128013	10128013	10128013
35	Seitenverkleidung oben	2	70130874	70130874	70130874
36	Seitenverkleidung unten	2	70113454	70113454	70113454
37	Pa U-Scheibe 12x15mm	4	10108131	10108131	10108131
39	Distanzhülse 66mm	2	70130825	70130825	70130825
40	Distanzhülse 45 mm	4	70130525	70130525	70130525
41	Anschlagwinkel unten	2	97201284	97201284	97201284
42	Begrenzungswinkel oben	2	97201819	97201819	97201819
43	Auslösehebel Nr. 1 rot	2	70130833	70130833	70130833
44	Auslösehebel Nr. 2 rot	2	70130834	70130834	70130834
45	Spreizniet 6x9,5mm	2	10418503	10418503	10418503
46	Stopfen 8mm	4	10100169	10100169	10100169
47	Reibschutz (Set 4Stück)	1	70130890	70130890	70130890
49	Schraubenbeutel o.Abb.	1	94180412	94180412	94180412
50	Schläger/Ball Set	1	—	—	07091-100
51	Abdeckhaube	1	—	—	07132-100

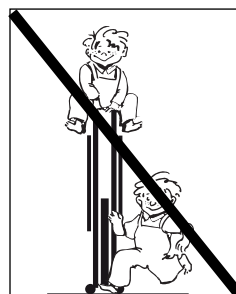
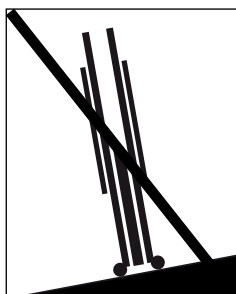



©2013 KETTLER® All rights reserved. No part of this manual may be reproduced, stored in a retrieval system, or transmitted in any form, or by any means, such as electronic, mechanical, photocopying or otherwise, without the prior written permission of KETTLER®.

KETTLER® International Inc.,
1355 London Bridge Road,
Virginia Beach, VA 23453 USA
www.kettlerusa.com • E-mail: info@kettlerusa.com
For parts/service: call 866-804-0440 or e-mail
parts@kettlerusa.com

Docu 07.27.13