

BougeRV

User Manual

**NEGATIVE GROUND
MPPT SOLAR CHARGE CONTROLLER**

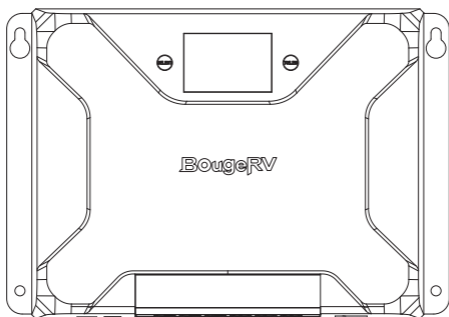

Content

1. Safety Instructions	1
2. Technical After Services	2
3. Identification Of Parts	3
4. LCD Display Interface Overview	4
5. System Wiring	5
6. Wiring Instructions	5
7. LCD Display Interface	7
7-1. Menu Display Icon	7
7-2. Key Operation	7
8. Working Mode	9
8-1. Working Mode 1: Load mode	9
8-2. Working Mode 2: No load mode	10
8-3. Working Mode 3: Viewing mode	11
9. Bluetooth module	12
10. Parameter setting menu	13
Menu 1: Battery type setting(Mode 1, Mode 2)	13
Menu 2: System voltage(Mode 1, Mode 2)	14
Menu 2.1: Boost charging voltage(Mode 1, Mode 2)	14
Menu 2.2: Floating charging voltage(Mode 1,Mode 2)	15
Menu 2.3: Boost charging reconnect voltage(Mode 1,Mode 2)	15
Menu 2.4: Equalizing charging voltage(Mode 1,Mode 2)	15
Menu 2.5: Over-discharge voltage(Mode 1)	15
Menu 2.6: Over-discharge delay(Mode 1)	16
Menu 2.7: Over-discharge reconnect voltage(Mode 1)	16
Menu 3: Solar panel output voltage(Mode 1,Mode 2,Mode 3)	16
Menu 4: Solar panel output current(Mode 1,Mode 2,Mode 3)	17
Menu 5: Generated energy of the day(Mode 1,Mode 2,Mode 3)	17
Menu 6: Load current(Mode 1,Mode 3)	17
Menu 7: Discharge energy of the day (mode 1, mode 3)	18
Menu 8: The controller temperature(mode 1, mode 2, mode 3)	18
Menu 9: The battery temperature(mode 1, mode 2,mode 3)	18

Menu 10: Load mode(mode 1)-----	19
Menu 10.1: Light control mode + Duration mode(mode 1)-----	20
Menu 11: Lithium battery low temperature charging protection (mode 1, mode 2)-----	20
Menu 12: Load short circuit protection(mode 1)-----	21
Menu 13: Charging current(mode 1, mode 2)-----	21
Menu 14: Constant voltage output of lead acid battery(mode 1, mode 2)-----	21
Menu 15: Light control voltage(mode 1)-----	22
Menu 16: Light control delay(mode 1)-----	22
Menu 17: Error code(mode 1, mode 2, mode 3)-----	22
11. System restart & Factory reset-----	23
Menu 18: System restart(mode 1, mode 2, mode 3)-----	23
Menu 19: Factory reset(mode 1, mode 2, mode 3)-----	23
12. Error Code-----	24
13. Base Specification-----	26
14. Battery Charge Parameter-----	27
15. TTL communication-----	29
16. RS485-----	29
17. CAN communication(Optional)-----	29
18. Charging-----	30
18-1. Charging of lead-acid battery-----	30
18-2. Charging of lithium battery-----	31
19. Product Dimensions-----	32

1. Safety Instructions

Please follow the safety instructions for operation, the damage caused by not following the safety instructions shall be borne by the individual.

⚠ Please save these instructions

1-1.General Safety Information

- 1.Read all of the instructions and cautions in the manual before installation.
- 2.There are no repairable parts for this controller,do not disassemble or attempt to repair the controller.
- 3.Keep the controller from the water.
- 4.Make sure all connections with controller are tight.
- 5.Please read the product installation steps to ensure all connections are correct.

1-2.Charge Controller Safety

- 1.NEVER connect the solar panel array to the controller without a battery. The battery must be connected first.
- 2.Ensure input voltage does not exceed 100 Voc to prevent permanent damage.
- 3.Ensure that the output current of the solar panel does not exceed the rated charging current of the controller.

1-3.Battery Safety

1. Do not let the positive (+) and negative (-) terminals of the battery touch each other.
2. Explosive battery gases may be present while charging. Be certain there is enough ventilation to release the gases.
3. Be careful when working with large lead-acid batteries. Wear goggles and have fresh water available in case there is contact with the battery acid.
4. Over-charging and excessive gas precipitation may damage the battery plates and activate material shedding on them. Too high of an equalizing charge or too long of one may cause damage. Please carefully review the specific requirements of the battery used in the system.

2. Technical After Services

BougeRV provides 1-on-1 Solar Solution.

If you have any questions during use, please feel free to contact us:

 **service@bougeRV.com**

 **1-408-656-8402**

 **www.bougeRV.com**

 **1-669-232-7427**
Whatsapp

If you could provide the following relevant information to our email (**service@bougeRV.com**); we can provide you with technical support solutions faster.

- (1)The connection method of the solar panels (series/parallel, quantity, voltage, power).
- (2)The voltage and battery type of the battery.
- (3)The pictures or videos of the controller: battery voltage, battery charging current, the output voltage of the solar panel.

3. Identification Of Parts

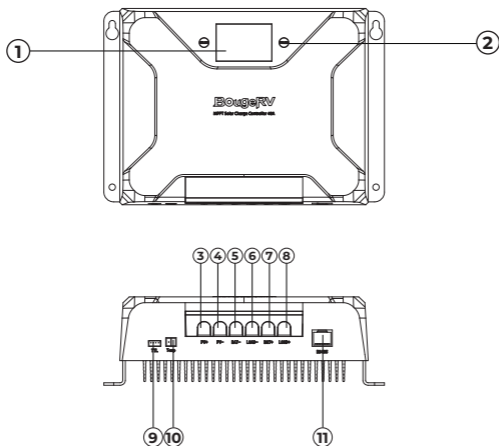

- ① LCD Display Screen
- ② Button
- ③ PV Positive Terminal
- ④ PV Negative Terminal
- ⑤ Battery Negative Terminal
- ⑥ Load Negative Terminal
- ⑦ Battery Positive Terminal
- ⑧ Load Positive Terminal
- ⑨ TTL Communication Interface
- ⑩ Temperature sensor Interface
- ⑪ RS485/CAN Communication Interface

4. LCD Display Interface Overview

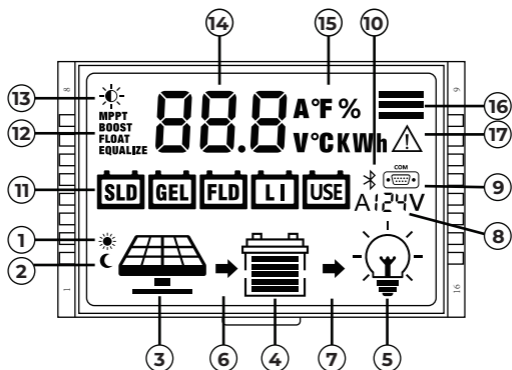

- | | |
|--------------------------------|---------------------------|
| ① Daytime icon | ⑩ Bluetooth icon |
| ② Night icon | ⑪ Battery type |
| ③ Solar panel | ⑫ Charging stage |
| ④ Battery | ⑬ Load light control icon |
| ⑤ Load | ⑭ Parameter |
| ⑥ Charging state | ⑮ Unit symbol |
| ⑦ Discharging state | ⑯ Operating mode |
| ⑧ System voltage | ⑰ Warning icon |
| ⑨ RS485/CAN communication icon | |

5. System Wiring

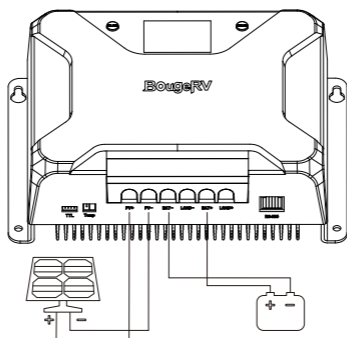

1. The positive and negative poles of the battery must be connected to the battery terminals of the controller first.
2. Finally, connect the positive and negative poles of the solar panel to the PV terminals of the controller.
3. Make sure that the Bluetooth of the mobile phone is turned on, and open the APP "Solar" to enter the setting interface.

6. Wiring Instructions

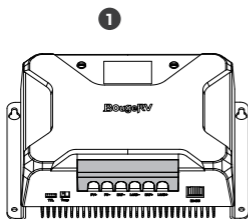

1. Remove the plastic cover. (Pick up)

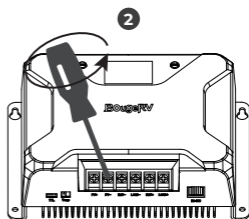

2. Unscrew the screws. (Counterclockwise)

3



3. Plug the cable into the correct port.

4

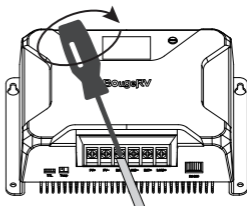

4. Tighten the screws.
(Clockwise)

5

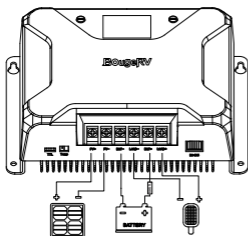

5. Check the wiring condition and put the plastic cover back. Please strictly follow the above sequence for connection.



Note:

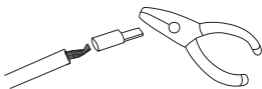











During the wiring process, the attached terminal lugs can be used for connection. After stripping the wire, put it into the terminal lugs and squeeze it with a crimping pliers.



7. LCD Display Interface

7-1.Menu Display Icon

Display Section	Status
Charge And Load Status	
Parameter	88.8 A°F % V°CkWh
BAT Type	SLD GEL FLD LI USE
Indicate And Warning	

Status Icon	Indication	Status	Description
	Day Night And Charge Indication	 On	Daylight Detected
		 On	No Daylight Detected
		 On	Solar Charging Battery
	Battery Indication		Battery Voltage is High
			Battery Voltage is Middle
			Battery Voltage is Low
	Load Indication		Load On
			Load Off
	System Error Indication	On	System Error - Check Error Code
		OFF	System Normally
	Voltage Indication	12V	12V System Voltage
		24V	24V System Voltage

7-2.Key Operation

1. Menu Switching



Press the button to scroll the menu backward to the previous menu.



Press the button to scroll the menu forward to the next menu.

2. Enter the Parameter Setting Interface



In the menu interface, press and hold the button for 2s to enter the menu parameter adjustment interface.

3. Adjust Parameters



Enter the parameter setting interface, press the button to adjust the parameter.(Decrease)



Enter the parameter setting interface, click the button to adjust the parameter.(Add)

4. Save Parameters



After adjusting the parameters, press and hold the button for 2s to confirm the setting parameters.

5. Working mode setting

5.1 Enter the working mode setting interface



On the main menu interface, press and hold the button for 5s to enter the working mode setting interface, and the working mode icon will display.

5.2 Adjust working mode



Enter the parameter setting interface, press the button to adjust the parameter.(Decrease)



Enter the parameter setting interface, click the button to adjust the parameter.(Add)

5.3 Save working mode setting



After adjusting the parameters, press and hold the button for 2s to confirm the setting parameters.

8. Working Mode

8-1 Working Mode 1: Load mode

Menu 1:
Battery type setting

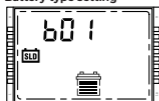

Menu 3:
Solar panel output voltage

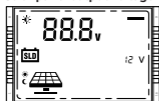

Menu 5:
Generated energy of the day

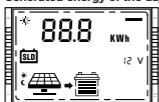

Menu 7:
Discharge energy of the day

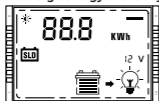

Menu 9:
The battery temperature

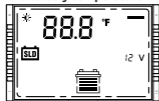

Menu 11:
Lithium battery low
temperature charging protection



Menu 12:
Load short circuit protection



Menu 2:
System voltage



Menu 4:
Solar panel output current



Menu 6:
Load current



Menu 8:
The controller temperature



Menu 10:
Load mode

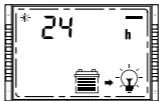

Menu 10.1:
Light control mode +
Duration mode



Menu 13:
Charging current

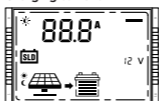

Charging Stage Menu

Menu 2.1:
Boost charging voltage

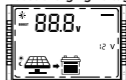

Menu 2.2:
Floating charging voltage



Menu 2.3:
Boost charging
reconnect voltage



Menu 2.4:
Equalizing charging
voltage



Menu 2.5:
Over-discharge voltage



Menu 2.6:
Over-discharge delay



Menu 2.7:
Over-discharge r
econnect voltage



Menu 14:
Constant voltage
output of lead acid battery



Menu 15:
Light control voltage

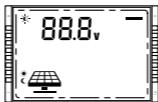

Menu 16:
Light control delay



Menu 17:
Error code



8-2 Working Mode 2: No load mode

Menu 1:
Battery type setting



Menu 2:
System voltage



Menu 3:
Solar panel output voltage

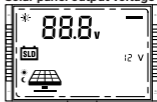

Menu 4:
Solar panel output current

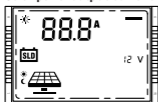

Menu 5:
Generated energy of the day

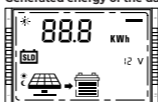

Menu 8:
The controller temperature

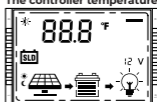

Menu 9:
The battery temperature

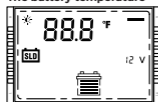

Menu 11:
Lithium battery low
temperature charging protection

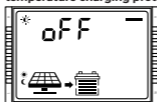

Menu 13:
Charging current

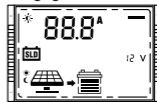

Menu 14:
Constant voltage output of
lead acid battery



Menu 17:
Error code

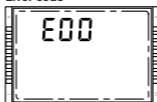

Menu 2: System voltage



Menu 2.1:
Boost charging voltage



Menu 2.2:
Floating charging voltage

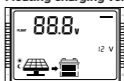

Menu 2.3:
Boost charging
reconnect voltage



Menu 2.4:
Equalizing charging
voltage



8-3 Working Mode 3: Viewing mode

It is recommended to switch to mode 3 after setting the system parameters, so that it is convenient to check the daily work of the PV system.

Menu 3:
Solar panel output voltage

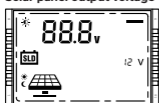

Menu 4:
Solar panel output current

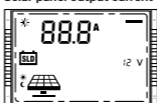

Menu 5:
Generated energy of the day

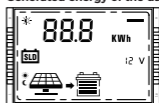

Menu 8:
The controller temperature

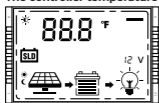

Menu 7:
Discharge energy of the day

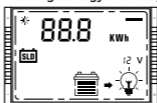

Menu 6:
Load current

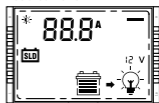

Menu 9:
The battery temperature

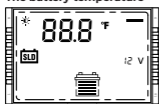

Menu 17:
Error code

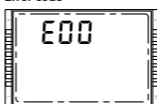

9. Bluetooth module

Built-in Bluetooth communication function can monitor the operation data, fault status and adjust the operation parameters of the controller in real time through mobile APP.

Download

Scan the QR code to download the application;



IOS & Android



Solar APP

Search for "**Solar App**" in the APP Store (for IOS devices) or Google Play (for Android devices).

10. Parameter setting menu

Main Menu

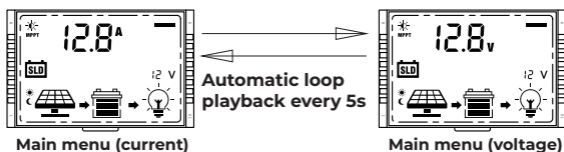

1. On the parameter setting interface, if there is no operation for 10s, it will automatically jump back to the main menu.
2. On the parameter setting interface, if the parameter is not confirmed, the parameter will keep flashing, confirm until the parameter does not flash, indicating that the parameter setting is successful.
3. The backlight turns off after 10s of no operation.

Menu 1: Battery type setting (Mode 1, Mode 2)

- ① SLD =Sealed lead acid battery
- ② GEL=GEL battery
- ③ FLD=Flooded lead acid battery
- ④ LI=Lithium iron phosphate battery/LiFePO₄
- ⑤ USE=Custom battery



Setting method:

1. On the battery type menu, press and hold **[SELECT]** for more than 2s until the parameter flashes to enter the battery type parameter setting interface.
2. On the battery type parameter setting interface, single press **[SELECT]** or **[ENTER]** to adjust the parameters.
3. After completing the parameter setting, press and hold **[ENTER]** for more than 2s until the parameter does not flash, and the parameter setting saves successfully; single press **[ENTER]** to switch to the next menu or automatically jump back to the main menu after 10s of no operation.

Menu 2: System voltage(Mode 1, Mode 2)

1. Automatically identify voltage
(only applicable to the lead-acid battery)

2. 12V

3. 24V

Setting method:

1. On the system voltage menu, press and hold [SELECT] for more than 2s until the parameter flashes to enter the system voltage parameter setting interface.
2. On the system voltage parameter setting interface, single press [SELECT] or [ENTER] to adjust the parameters.
3. After completing the parameter setting, press and hold [ENTER] for more than 2s until the parameter does not flash, and the parameter setting saves successfully; single press [ENTER] to switch to the next menu or automatically jump back to the main menu after 10s of no operation.

Note: The system voltage will take effect after the system voltage setting saves successfully.

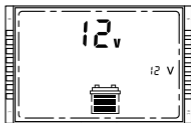

Menu 2.1: Boost charging voltage(Mode 1, Mode 2)

① 12V system:

9-17V, 0.1V step (default 14.4V)

② 24V system:

18-34V, 0.2V step (default 28.8V)

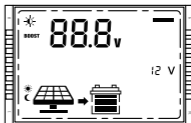

Note:

This menu will only appear when the battery type is set to **LI** or **USE**.

Setting method:

1. On the boost charging voltage menu, press and hold [SELECT] for more than 2s until the parameter flashes to enter the boost charging voltage parameter setting interface.
2. On the boost charging voltage parameter setting interface, single press [SELECT] or [ENTER] to adjust the parameters.
3. After completing the parameter setting, press and hold [ENTER] for more than 2s until the parameter does not flash, and the parameter setting is successful; single press [ENTER] to switch to the next menu or automatically jump back to the main menu after 10s of no operation.

Menu 2.2: Floating charging voltage(Mode 1, Mode 2)

①12V system:

9-17V, 0.1V step (default 13.8V)

②24V system:

18-34V, 0.2V step (default 27.6V)

Note:

This menu will only appear when the battery type is set to **USE**.

Setting method: Same as above.

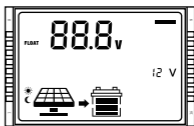

Menu 2.3: Boost charging reconnect voltage (Mode 1, Mode 2)

①12V system:

9-17V, 0.1V step (default 13.2V)

②24V system:

18-34V, 0.2V step (default 26.4V)

Note:

This menu will only appear when the battery type is set to **LI** or **USE**.

Setting method: Same as above.

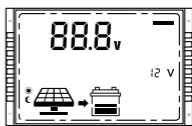

Menu 2.4: Equalizing charging voltage(Mode 1, Mode 2)

①12V system:

9-17V, 0.1V step (default 14.6V)

②24V system:

18-34V, 0.2V step (default 29.2V)

Note:

This menu will only appear when the battery type is set to **USE**.

Setting method: Same as above.

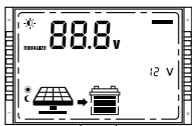

Menu 2.5: Over-discharge voltage(Mode 1)

①12V system:

9-17V, 0.1V step (default 11.1V)

②24V system:

18-34V, 0.2V step (default 22.2V)

Note:

This menu will only appear when the battery type is set to **LI** or **USE**.

Setting method: Same as above.

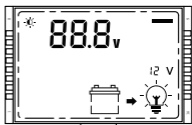

Menu 2.6: Over-discharge delay(Mode 1)

1-60s. (default 5s)

Note:

This menu will only appear when the battery type is set to **USE**.

Setting method: Same as above.

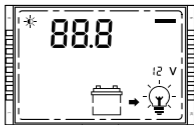

Menu 2.7: Over-discharge reconnect voltage(Mode 1)

①12V system:

9-17V, 0.1V step (default 12.6V)

②24V system:

18-34V, 0.2V step (default 25.2V)

Note:

This menu will only appear when the battery type is set to **LI** or **USE**.

Setting method: Same as above.

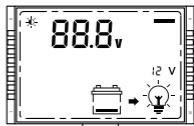

Menu 3: Solar panel output voltage (Mode 1, Mode 2, Mode 3)

Display solar panel output voltage.

Note:

The voltage value only can be read, but cannot be adjusted;

Setting method: Same as above.

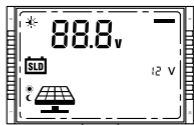

Menu 4: Solar panel output current (Mode 1, Mode 2, Mode 3)

Display solar panel output current.

Note:

The current value only can be read, but cannot be adjusted;

Setting method: Same as above.

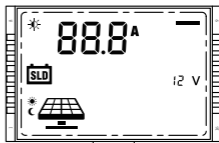

Menu 5: Generated energy of the day (Mode 1, Mode 2, Mode 3)

Display generated energy of the day.

Note:

The value only can be read, but cannot be adjusted;

Setting method: Same as above.

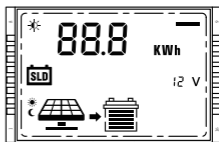

Menu 6: Load current (Mode 1, Mode 3)

Displays the output current at the load port of the controller.

Note:

The value only can be read, but cannot be adjusted;

Setting method: Same as above.

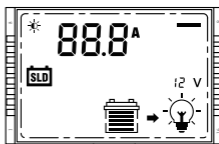

Menu 7: Discharge energy of the day(mode 1, mode 3)

Display the output energy of the controller load port of the day.

Note: The value only can be read, but cannot be adjusted;

Setting method: Same as above.

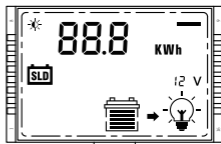

Menu 8: The controller temperature (mode 1, mode 2, mode 3)

Display the controller temperature.

- ① °F (defaults)
- ② °C

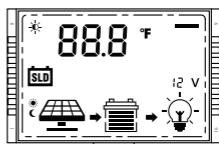

Setting method:

1. On the controller temperature menu, press and hold [SELECT] for more than 2s until the parameter flashes to enter the controller temperature parameter setting interface.
2. On the controller temperature parameter setting interface, single press [SELECT] or [ENTER] to choose the °F or °C .
3. After completing the parameter setting, press and hold [ENTER] for more than 2s until the parameter does not flash, and the parameter setting is successful; single press [ENTER] to switch to the next menu or automatically jump back to the main menu after 10s of no operation.

Menu 9: The battery temperature (mode 1, mode 2, mode 3)

Display the battery temperature.

- ① °F (defaults)
- ② °C

Setting method: Same as above.

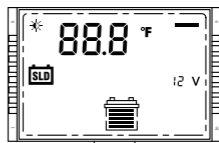

Menu 10: Load mode(mode 1)

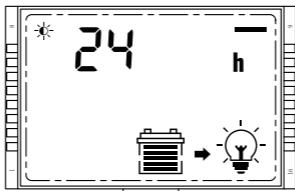

Setting method: Same as above.

LCD screen number	Load mode	Description
24h	Normal on mode	The load is always on.
000	Manual mode	On the main menu interface, press and hold [ENTER] for more than 2s to turn on/off the load. (not affected by light control)
0h	Pure light control, turn on the load at night and turn off the load during the day	When there is no sunlight , the solar panel voltage is less than the light control on voltage, the controller delays for 1 minute and then turns on the load ; When there is sunlight , the solar panel voltage is higher than the light control off voltage,the controller delays for 1 minute and then turns off the load ;
00h	Pure light control turns on the load during the day and turns off the load at night	When there is no sunlight , the solar panel voltage is less than the light control on voltage, the controller delays for 1 minute and then turns off the load ; When there is sunlight , the solar panel voltage is higher than the light control off voltage,the controller delays for 1 minute and then turns on the load

LCD screen number	Load mode	Description
display: 11, setting is usually 1-14h	Pure light control,turn on the load at night and turn off the load during the day + time control	When there is no sunlight , the solar panel voltage is less than the light control on voltage, the controller delays for 1 minute and then turns on the load ; When there is sunlight , the solar panel voltage is higher than the light control off voltage,the controller delays for 1 minute and then turns off the load;
display: 22, setting is usually 01-014h	Pure light control turns on the load during the day and turns off the load at night + time control	When there is no sunlight , the solar panel voltage is less than the light control on voltage, the controller delays for 1 minute and then turns off the load ; When there is sunlight , the solar panel voltage is higher than the light control off voltage,the controller delays for 1 minute and then turns on the load.

Menu 10.1: Light control mode + Duration mode (mode 1)

The adjustment range is 1-14 hours.

- ① When menu 10 selects 11: 1-14h, 1 step (default 1h)
- ② When menu 10 selects 22: 01-014h, 1 step (default 1h)

Setting method: Same as above.

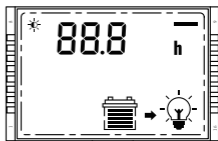

Menu 11: Lithium battery low temperature charging protection (mode 1, mode 2)

- ① **oFF:** Turn off protection (default)
- ② **on:** Turn on the protection (the temperature sensor detects that the temperature is $\leq 0^{\circ}\text{C}$ (32°F), start the low temperature charging protection, and do not charge the lithium battery until the battery temperature returns to 2°C (35.6°F).

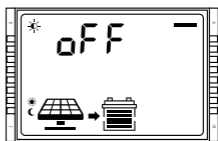

Note:① Make sure to connect the temperature sensor when turn on the lithium battery low temperature charging protection.

② This menu will only appear when the battery type is set to **LI** or **USE**.

Setting method: Same as above.

Menu 12: Load short circuit protection (mode 1)

- ① on: open load short-circuit protection (default)
- ② off: close load short-circuit protection

Setting method: Same as above.

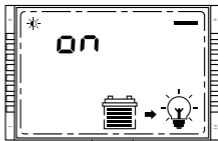

Menu 13: Charging current (mode 1, mode 2)

Adjust current range: 0—rated current
(for example: the 60A controller, adjusting current range is 0-60A)

- ① Set 0: No charging
- ② Set 1—rated current: Limit charging current (1 step)

Default: rated current

Setting method: Same as above.

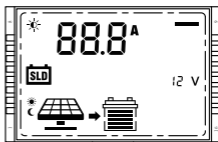

Menu 14: Constant voltage output of lead acid battery (mode 1, mode 2)

- ① off: The controller can not output without battery. (default)
- ② on: The controller can output without battery.

Note: When the lead-acid battery cannot work due to over-discharge, this function can be turned on, and the controller can activate the lead-acid battery with constant voltage output lead acid battery activation.

Setting method: Same as above.

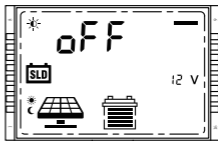

Menu 15: Light control voltage(mode 1)

- ①12V system voltage: 5-11V, 5V(default)
- ②24V system voltage: 10-22V, 10V(default)

Note:

- ①Light control on: The solar panel voltage is less than the adjusting voltage.
- ② If it is the system of 24V, relevant voltage points shall be automatically multiplied by 2.

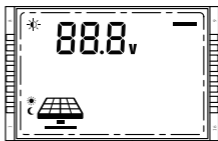

Setting method: Same as above.

Menu 16: Light control delay(mode 1)

Adjust voltage range: 0-960s, step 60s.
Default: 60s.

Note: Minimum duration required to meet the light control on or off condition.

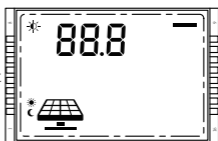

Setting method: Same as above.

Menu 17: Error code(mode 1, mode 2, mode 3)

E00: The system is working normally.

Note: It can only be viewed, and it shows that the E00 system is working normally, and other error codes need to be checked.



Setting method: Same as above.

11. System restart & Factory reset

Menu 18: System restart(mode 1, mode 2, mode 3)

On the main menu, press and hold **[ENTER]** for more than 5s until the parameter flashes to enter the parameter setting interface.

2. On the parameter setting interface, single press **[SELECT]** or **[ENTER]** to choose **F01** or **F02**.

3. After completing the parameter setting, press and hold **[ENTER]** for more than 2s until the parameter does not flash, and the parameter setting is successful.

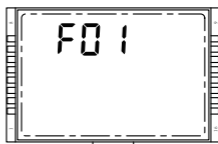





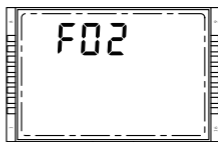

Menu 19: Factory reset (mode 1, mode 2, mode 3)







F02

Setting method: Same as above.

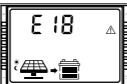

12. Error Code

Error code	Cause of failure	Solution
	Normal system	/
	Battery over-discharge	1.Turn off load output, after the battery voltage recover to the over -discharge reconnect voltage, relieve over-discharge to restore load output. 2.The battery voltage does not match the system, check the system voltage.
	Battery over-voltage	Stop charging, check and find out the cause of high battery voltage. The charging will be automatically restored after the battery voltage is lowered.
	Battery under-voltage warning	Battery voltage below undervoltage warning threshold, warning only.
	Load short-circuited	Turn off load output.
	Load over-current	Turn off load output, and perform delay protection by a multiple of rated current.
	Controller high temperature abnormal state	Charging will be stopped when the controller temperature is above 75°C and recover when it is below 70°C.

Error code	Cause of failure	Solution
	Battery high temperature charging protection	Charging will be stopped when the battery temperature is above 75°C and resumed when it is below 70°C.
	Solar panel over-voltage	Stop charging when the output voltage of the solar panel is higher than 95V, and recover charging when the voltage is lower than 90V.
	Lead acid battery is not connected	In lead-acid battery mode, the battery is damaged or not connected.
	Battery high temperature discharging protection	Load output will be turned off when the battery temperature is above 75°C and recover when it is below 70°C.
	Battery low temperature discharging protection	Load output will be turned off when the battery temperature is below -35°C and resumed when it is above -30°C
	Overcharge protection	Turn off charging, the battery voltage is higher than the over-voltage voltage, turn off charging, the battery voltage drops, and recover after 10s.
	Battery low temperature charging protection	Charging will be stopped when the battery temperature is below -35°C and resumed when it is above -30°C
	Charging and discharging disabled by system setting	System charging or discharging failure.

13. Base Specification

Model	BJ2430N	BJ2440N	BJ2460N
System voltage	12V/24V		
Rated charging current	30A	40A	60A
Battery Type	SLD/GEL/FLD/LI/USE,SLD as default		
Maximum input of PV system	450W/12V 900W/24V	600W/12V 1200W/24V	900W/12V 1800W/24V
Maximum PV input voltage	100V (95V protection, 90V recovery)		
MPPT operating voltage range	(Battery voltage +2V)~72V		
MPPT tracking efficiency	>99%		
Charging conversion efficiency	>95%		
Rated load current	20A		
Charging current setting	√		
Lithium battery low temperature charging protection	√		
Constant voltage output setting	√		
Charging temperature compensation of lead-acid battery	√		
Temperature unit setting	√		
Overload/ Short-circuit protection	√		

Battery operating voltage range	8V-32V		
TTL communication	Baud rate: 9,600 bps		
RS485 communication	RJ45 interface, with power output 5V/200 mA,The baud rate is 9,600 bps by default, adjustable.		
Bluetooth communication	built-in bluetooth		
CAN communication	RJ45 interface, optional (RV-C protocol)		
Historical data	Save the last 200 days of historical data		
Protection function	PV overvoltage protection, PV reverse connection protection, PV short circuit protection, night reverse charging protection, input power limit protection, over-temperature protection, load short-circuit protection, overload protection, battery over-voltage/over-discharge protection, battery reverse connection protection, battery end short circuit protection.		
Grounding type	Grounding of common negative electrode		
Operating ambient temperature range	-31°F~149°F (-35°C~65°C)		
Protection grade	IP34		
Cooling mode	Natural heat dissipation		
Weight	1076g	1789g	2503g

14. Battery Charge Parameter

Battery parameters					
Battery Type Setting/ Voltage	Sealed Lead-Acid SLD	Gel lead-acid battery GEL	Flooded lead -acid battery FLD	Lithium battery LI	Custom battery USE
Overvoltage disconnect voltage ^①	16.0V	16.0V	16.0V	16.0V	16.0V
Equalizing voltage ^①	14.6V	--	14.8V	--	0-17V (Default 14.6V) Note: Set to 0, (Do not turn on the equalization charging function)
Boost voltage ^①	14.4V	14.2V	14.6V	9-17V (Default 14.4V)	9-17V (Default 14.4V)
Float charge voltage ^①	13.8V	13.8V	13.8V	--	0-17V (Default 13.8V) Note: Set to 0, (Do not turn on the float charging function)
Boost charging reconnect voltage ^①	13.2V	13.2V	13.2V	13.2V	9-17V (Default 13.2V)
Over-discharge restoring voltage ^①	12.6V	12.6V	12.6V	12.6V	9-17V (Default 12.6V)
Under-voltage alarming voltage ^①	12.0V	12.0V	12.0V	12.0V	12.0V
Over-discharge voltage ^①	11.1V	11.1V	11.1V	11.1V	9-17V (Default 11.1V)
Over-discharge cut off voltage ^①	10.6V	10.6V	10.6V	10.6V	10.6V
Over-discharge delay	5s	5s	5s	5s	1-60s (Default 5s)
Equalizing charging interval	30 days	--	30 days	--	30 days Note: If the equalization charging voltage is set to 0, there is no equalization charging interval (l)
Equalizing charging duration	120 min	--	120 min	--	120 min Note: If the equalization charging voltage is set to 0, there is no equalization charging duration (l)
Boost charging duration	120 min	120 min	120 min	--	120 min Note: If the equalization charging voltage is set to 0, there is no boost charging duration (l)
Temperature compensation factor (mV/°C/2V)	-3	-3	-3	--	Default: -3

Note:

① The above values are the parameters at 25°C/12V; if it is the system of 24V, relevant voltage points shall be automatically multiplied by 2.

15. TTL communication

1) Default baud rate: 9,600 bps; check bit: none; data bit: 8 bit; stop bit: 1 bit

2) Communication power supply output specification:
(8.5V±1V)/: 100mA

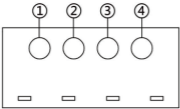
 <p>TTL-COM</p>	S/N	Definition
	①	VCC: communication power supply output
	②	RX: controller data receiving end
	③	TX: controller data transmitting end
	④	GND

16. RS485

1) RS485 communication:

Default baud rate: 9,600 bps; parity bit: none; data bit: 8 bit; stop bit: 1 bit Interface type: RJ45, communication power supply output specification: 5V/200mA

2) RJ45 interface communication line sequence definition:

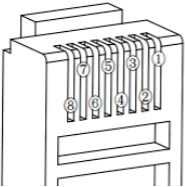
	S/N	Definition
	①	Positive terminal
	②	D+
	③	D-
	④	Power ground/signal ground
	⑤	NC
	⑥	NC
	⑦	CAN_H
⑧	CAN_L	

Note: NC represents an empty pin, which means that the pin is not connected.

17. CAN communication(Optional)

1) CAN communication: support RV-C protocol

18. Charging

18-1: Charging of lead-acid battery

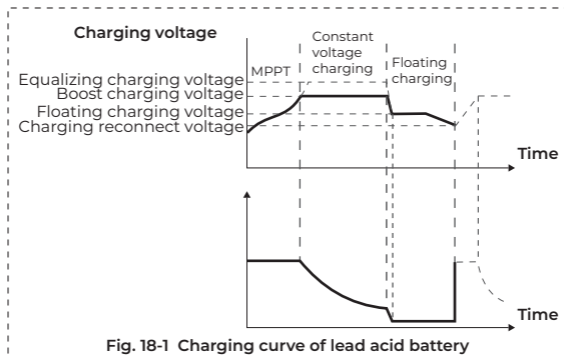

Fig. 18-1 Charging curve of lead acid battery

Select such battery types as SLD/FLD/GEL/USE, and select the appropriate system voltage.

As shown in **Fig. 18-1**, the charging stages of lead-acid battery are: MPPT charging, constant voltage charging (equalizing/boost/floating charging), and current-limiting charging.

The constant voltage charging is divided into three stages: equalizing charging, boost charging and floating charging

[MPPT charging] When the battery voltage has not reached the target constant voltage value, the controller will perform MPPT charging. When the battery voltage reaches the constant voltage value, it will automatically exit MPPT charging and switch to constant voltage charging (equalizing/boosting/floating charging).

[Equalizing charging] Regular equalizing charging is good for some batteries. Equalizing charging is mainly to make the charging voltage of battery higher than the standard supplementary voltage, besides, it can vaporize the battery electrolyte to balance the battery voltage and complete relevant chemical reaction. Equalizing charging and boosting charging are not repeated during one full charging to avoid excessive gas evolution or overheating of the battery.

Notes:

- 1) Since the equalizing charging of flooded lead-acid battery produces explosive gas, the battery compartment must be well ventilated.
- 2) Although the equalizing charging elevates the battery voltage, it may damage the level of sensitive DC loads, therefore, it is necessary to verify that the allowable input voltage of all loads in the system is greater than the set battery voltage value in equalizing charging.

3) Excessive charging and excessive gas evolution may damage the battery plate and cause the active substances on the battery plate to fall off. Besides, excessive high equalizing charging voltage or excessive long equalizing charging duration may damage the battery. Please set relevant parameters according to the specifications of the battery used in the system.

[Boost charging] The duration of boost charging is 2 h (default). When the duration reaches the set value, the system will switch to floating charging.

[Floating charging] Floating charging is the last constant voltage charging stage in the charging cycle of lead-acid battery. The controller keeps the charging voltage constant at the floating charging voltage. At this stage, the battery is charged with a very weak current to ensure that the battery is in full-charging. When the battery voltage is as low as the reconnect voltage of boost charging, the system will exit the floating charging stage and re-enter the next charging cycle.

18-2: Charging of lithium battery

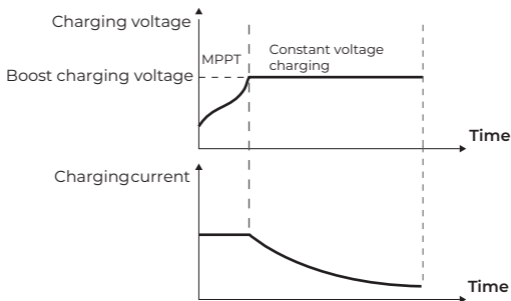

Fig. 18-2 Charging curve of lithium battery

Select such battery types as LI, and select the system voltage from 12V/24V.

As shown in **Fig. 18-2**, the charging stages of lithium battery are: MPPT charging/boost charging/current-limiting charging.

[MPPT charging] When the battery voltage does not reach the target constant voltage value, the controller conducts MPPT charging to charge the battery with maximum solar power, when reaches, it automatically switches to boost charging.

[Boost charging] In the boost charging stage of lithium battery, when the battery voltage is lower than the boost charging voltage, the system conducts MPPT charging or current-limiting charging, when reaches, it switches to boost charging.

19. Product Dimensions

BJ2430N

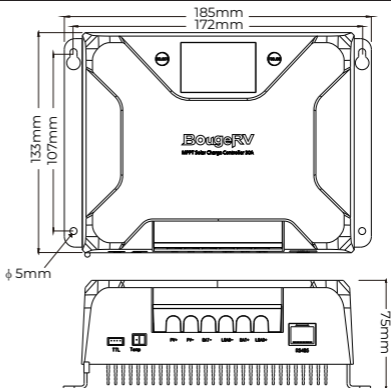

Model: BJ2430N

Product dimension: 185*133*75mm

Fixed hole position: ϕ 5mm

BJ2440N

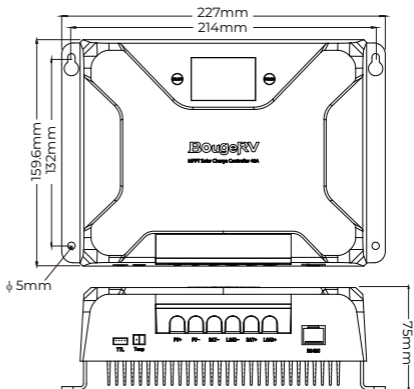

Model: BJ2440N

Product dimension: 227*159.6*75mm

Fixed hole position: ϕ 5mm

BJ2460N

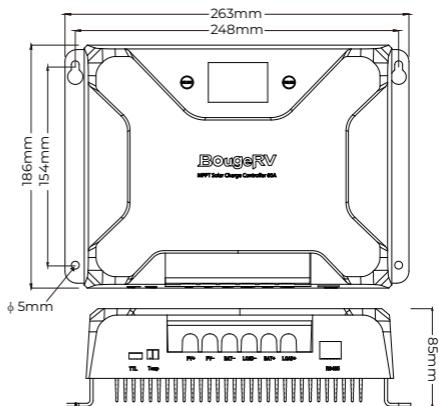

Model: BJ2460N

Product dimension: 263*186*85mm

Fixed hole position: $\phi 5\text{mm}$

BougeRV

Make the journey



service@bougerv.com



1-408-656-8402



www.bougerv.com



WhatsApp

1-669-232-7427