

**BougeRV**

# USER MANUAL

MODEL  
CR35/CR45/CR55

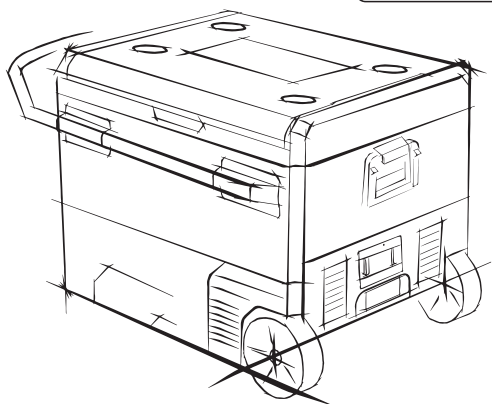

MODEL  
E35/E45/E55

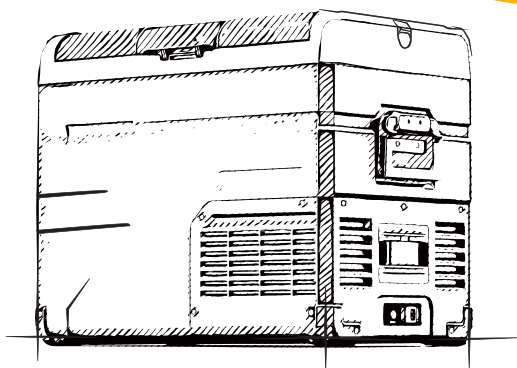

Please read this operating manual carefully before starting the device.  
Keep it in a safe place for future reference.

# Contents

1.Safety Instructions	-----	Page01
2.Product Features	-----	Page02
3.Product Structure	-----	Page02
4.Reverse Door Opening Direction	-----	Page03
5.Function and Operation	-----	Page04
6.Cleaning and Storage	-----	Page07
7.Troubleshooting	-----	Page08
8.Warranty and Maintenance	-----	Page09
9. Technical Information	-----	Page10
10.Smart Control-Fridge APP Instructions	-----	Page11

## 1. Safety Instructions



**WARNING!** Failure to obey these warnings could result in malfunction of your device and possible injury for yourself and other users.

- Do not operate the device if it is visibly damaged.
- Do not block the gaps of the device with things like pin, wire, etc.
- Do not expose the device to rain or soak it in water.
- Do not place the device near naked flames or other heat sources (heaters, direct sunlight, gas ovens etc.)
- Do not store explosive substances like spray cans with flammable propellants in the device.
- Before starting the device, ensure that the power supply line and the plug are dry.
- Check if the voltage specification on the type plate matches that of the energy supply.
- Once unpacked and before turning on, the device must be placed on a level surface for more than 6 hours.
- Make sure that the device stays horizontally when it is running. The tilt angle must be less than 5° for long time running and be less than 45° for short time running.
- The refrigerator must be well ventilated for heat dissipation and make sure to keep some space around it (Back Space  $\geq$  200mm, Side Space  $\geq$  100mm).
- The device may only be repaired by qualified personnel. Improper repairs can lead to safety hazards. If the power cable is damaged, it must be replaced by the manufacturer, customer service or a similarly qualified person in order to prevent safety hazards.



### NOTICE!

- The device can be used by children aged 8 or over, as well as by persons with reduced physical, sensory or mental capabilities or a lack of experience and/or knowledge, providing they are supervised or have been taught how to use the device safely and are aware of the resulting risks.
- Children must be supervised to ensure that they do not play with the device.
- The installation of DC power in the boat must be handled by qualified electricians.
- Disconnect the device or switch it off when you turn off the engine. Otherwise you may discharge the battery.



### CAUTION!

- Food is suggested to be stored in its original packaging or in suitable containers.
- Set suitable temperature for food or medicine stored in the device. Refer to recommended temperature for common food on Part 5.

## 2.Product Features

- High-efficiency DC compressor and conversion module.
- CFC free and great heat insulation.
- Fast cooling to -20°C/-4°F (based on 25°C/77°F room temperature).
- LCD digital display for temperature setting.
- Dual compartments with individual temperature control.
- Three stage battery protection system prevents vehicle run out of battery.

## 3.Product Structure

### \*Model CR35/CR45/CR55

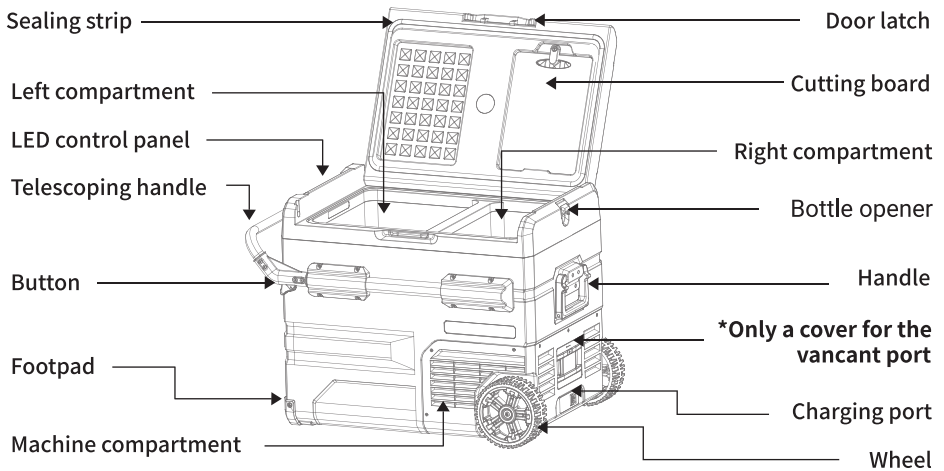

\*there are buttons on both sides of the telescoping hand, press them at the same time to pull the rod.



## \*Model E35/E45/E55

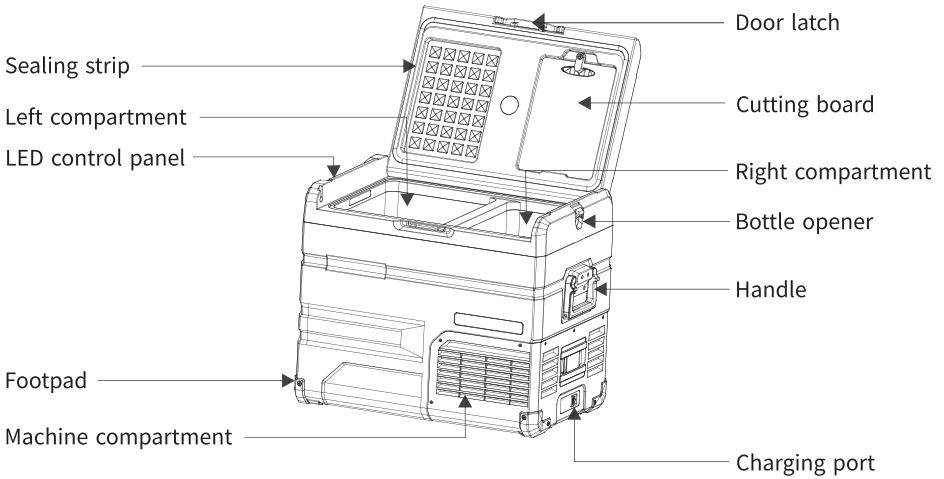

**!** \*The cutting board can be moved by turning the knob on the top cover, it is suggested to clean and dry it after every use.

### 4.REVERSE DOOR OPENING DIRECTION

The door opening direction can be changed according to actual needs, please follow the instructions below:

#### Door Disassembly:

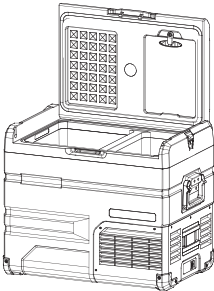

Open the door at a 90° angle

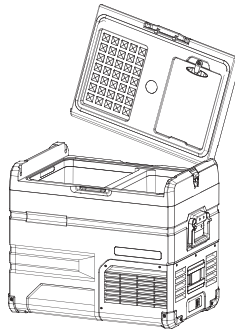

Take off the door from one side

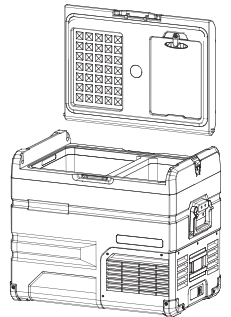

Take off the door from the other side

## Door Installation:

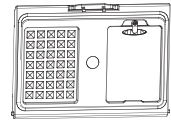

Reverse the door opening direction

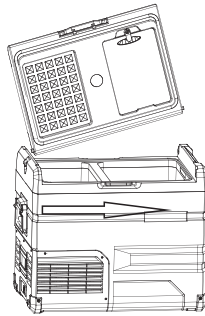

Align the door shaft with the hole on one side and insert it

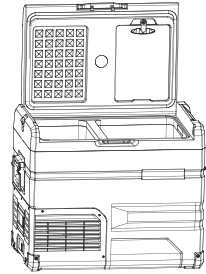

Fix the door on the other side, installation finished

## 5. Function and Operation

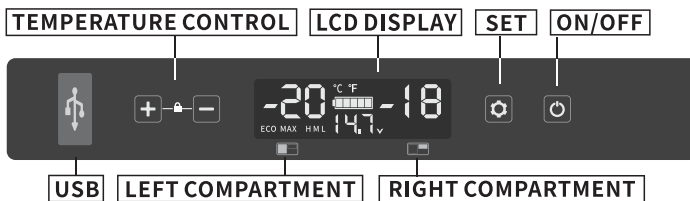

- **Power supply:** connect to 12V/24V DC power , 100~240V AC power(using the adapter), or use back-up lithium battery which can be recharged by solar(12~50V).
- **Display Screen Initialization:** connect to the power supply, the buzzer will make a long beep, and the display will be on for 2 seconds then enter the normal operating mode.
- **Power On/Off:** Press one time to turn on; Press and hold about 3 seconds to turn off.
- **Temp adjustment of the left compartment:** When both left and right compartments are set in running state, press **+** or **-** to enter left compartment temperature setting, press **+** to increase temperature, press **-** to decrease temperature.
- **Temp adjustment of the right compartment:** Press **+** or **-** , when the temp on the left flash, press to switch left/right compartment. When the temp of right flash, you can press the **+** or **-** to adjust the temp. The setting will be saved after stop operating for four seconds (Note: the temperature displayed is the current temperature of the compartments, it'll take a while to reach the set temperature.)  
Temperature setting range: -20~20°C (-4~68°F)

• **Compartment ON/OFF:** under the running state, long press **+** and **⚙** at the same time for three seconds to switch ON/OFF the left compartment, long press **-** and **⚙** at the same time for three seconds to switch ON/OFF the right compartment, two compartments cannot be switched off at the same time.

When the compartment is turned off meaning that you don't use it, it'll display three horizontal lines instead of a temperature.

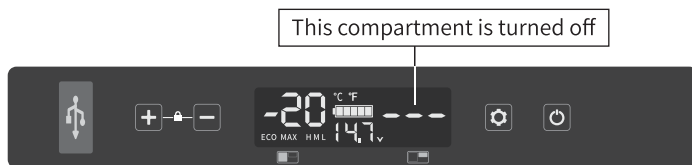

• **Cooling Mode:** under the running state, press **⚙** to switch MAX(fast cooling) and ECO (Energy saving Mode).(\*Factory setting is MAX.)

• **Battery Protection Mode:** under the running state, long press **⚙** for three seconds until screen flashes, then press **⚙** again to select protection mode H(High), M(Middle) and L(Low) (\*Factory setting is H.)

Due to the different output voltages between vehicles, H should be set when the product is connected to car power, and M or L should be set when it is connected to a portable battery or other back-up battery.



The battery gear should be set from H to M or from M to L if there is a voltage protection code F1 shown on the panel. The battery gear should be set to H if the product keeps working after turning off the car engine, or the product may drain the battery.

**Voltage Reference:**

INPUT MODE	DC 12V		DC 24V	
	CUT OUT	CUT IN	CUT OUT	CUT IN
L	9.0V	10.9V	21.3V	22.7V
M	10.1V	11.4V	22.3V	23.7V
H	11.1V	12.4V	24.3V	25.7V

\*the voltage is theoretical value, there may be a deviation in different sceneries.

\*USB output: +5V DC/1A, suitable for small devices like mobile phones, tablets, etc.





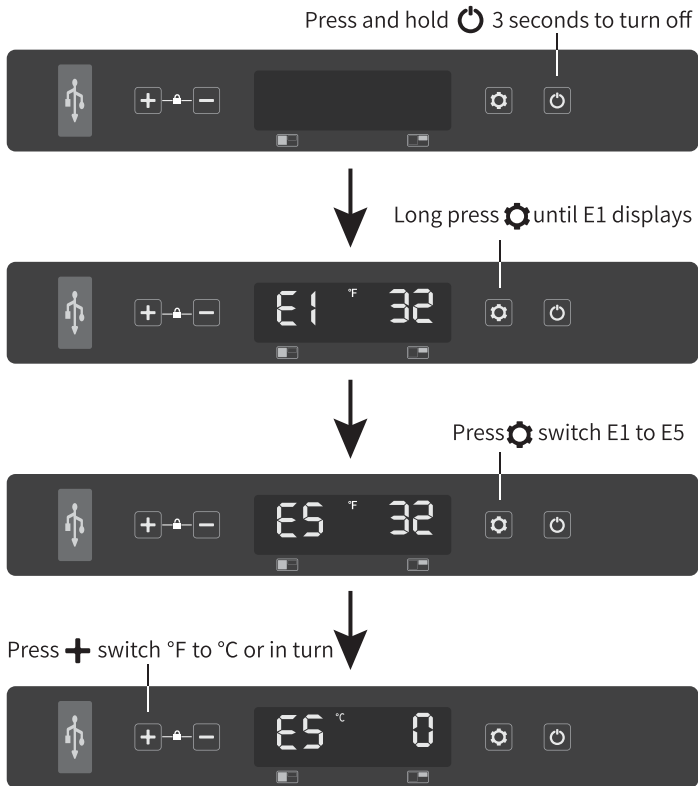

- **Temperature Unit Setting:** switch off the fridge, long press  for three seconds until E1 displays, then switch to E5 by pressing  again. Under E5 mode, press **+** or **-** to select Celsius or Fahrenheit. (\*Factory setting is °F.)

For easy operation, please download the APP referring to page 11.



- **Reset:** switch off the fridge, long press  for three seconds until E1 displays, under E1 mode, long press **+** **-** at the same time for three seconds to reset it.

### ■ Recommended temperature for common food:

						
Drinks	Fruits	Vegetable	Delicatessen	Wine	Ice cream	Meat
5°C/41°F	5~8°C/41~46°F	3~10°C/37~50°F	4°C/39°F	10°C/50°F	-10°C/14°F	-18°C/0°F

## 6. Cleaning and Storage

### ■ Cleaning:

- Unplug the device first to avoid electric shock.
- Use wet cloth to clean the device and dry it.
- Remove the cover and drain from the hole at the bottom of the device.
- Do not soak the device in water and do not wash it directly.
- Do not use abrasive cleaning agents as these can damage the device.

### ■ Storage:

If the device will not be in use for a long time, please follow the steps:

- Turn off the power and remove the plug.
- Remove all the items stored in the device.
- Remove the cover and drain from the hole, wipe off excess water with a soft rag.
- Leave the lid slightly open to prevent odors from forming.
- Put the device in a cool and dry place.

### ■ Defrosting:

Humidity can form frost in the interior of the cooling device or on the evaporator, which will affect the cooling performance. Defrost the device regularly to avoid this.

- Switch off the device.
- Take out the contents of the device.
- Keep the lid open.
- Remove the cover and drain from the hole.
- Wipe off the defrosted water.



**Never use hard or sharp tools to remove ice or to loosen objects which have frozen in place.**

## 7.Troubleshooting

Issues	Suggestions
<b>Refrigerator does not work</b>	Check if the switch is on.
	Check if the plug and socket are connected well.
	Check if the fuse has been burnt.
	Check if the power supply is malfunctioned.
	Switching on/off the fridge frequently may cause start delay of the compressor.
<b>Refrigerator compartments are too warm</b>	The door is opened frequently.
	A large amount of warm or hot food was stored recently. Wait for the refrigerator to reach its selected temperature.
	The refrigerator has been disconnected for a period of time.
<b>Food is frozen</b>	The temperature was set too low, please increase the temperature.
<b>There is a “water flow” noise from inside the fridge</b>	It's a normal phenomenon, caused by the flow of refrigerant.
<b>There are waterdrops around the refrigerator casing or door gap</b>	It's a normal phenomenon, the moisture will condense to water when it touches a cold surface of the refrigerator.
<b>The compressor is slightly noisy when starting</b>	It's a normal phenomenon, the noise will be reduced after the compressor works stably.
<b>Code F1 displayed</b>	Possible cause: low voltage to fridge. Adjust the battery protection from H to M or from M to L.
<b>Code F2 displayed</b>	Possible cause: condenser fan is overloaded. Disconnect power to fridge for 30 minutes & re-start.
<b>Code F3 displayed</b>	Possible cause: the compressor starts too frequently. Disconnect power to fridge for 30 minutes & re-start.
<b>Code F4 displayed</b>	Possible cause: compressor not kicking in. Disconnect power to fridge for 30 minutes & re-start.
<b>Code F5 displayed</b>	Possible cause: overheating of the compressor & electronics. Disconnect power to fridge for 30 minutes & re-start.
<b>Code F6 displayed</b>	Possible cause: no parameter can be detected by the controller. Disconnect power to fridge for 30 minutes & re-start.
<b>Code F7 or F8 displayed</b>	Possible cause: temperature sensor is faulty. Contact manufacturer for service.

## 8. Warranty and Maintenance

### Warranty

BougeRV PORTABLE CAR REFRIGERATOR comes with a 2-year warranty that commences from the date of purchase on BougeRV Amazon Store or BougeRV Official Website, except following situations:

- Contrived damage.
- Damage caused by force majeure such as earthquake, conflagration, etc.
- Damage from inappropriate use or violating this instruction.
- Damage or malfunction caused by disassembling.

✔ 24-month limited warranty

🔗 Lifetime technical support

### Customer Service

If there is any problem with the operation or use of the product, please feel free to contact us via:

■ Amazon:

✉ service@bougeRV.com

📞 +1 408 656 8402  
9AM-6PM(PST) Monday-Friday

+1 699 232 7427  
6PM-3AM(PST) Sunday-Thursday

■ BougeRV Website:

✉ support@bougeRV.com

📞 +1 408 656 8402  
9AM-6PM(PST) Monday-Friday

+1 408 429 4149  
6PM-3AM(PST) Sunday-Thursday

### VIP Service & Extra 1-year Warranty

#### Option 1

1. Search "QR Code" on your FB
2. Scan the QR Code beside
3. Join "BougeRV Car Refrigerator Club"
4. You become a VIP and get a 3-year warranty



#### Option 2

1. Search "BougeRV.com"
2. Support--Warranty Registration
3. Sign up and submit
4. You become a VIP and get a 3-year warranty

## 9. Technical Information

Mode	CR35	CR45	CR55
Rated Voltage	DC 12V/24V, AC100~240V(using the adapter)		
Rated Power Input	60W		
Capacity	35L/37QT/1.3cu.ft.	45L/48QT/1.6cu.ft.	55L/59QT/2.0cu.ft.
Noise Emission	≤45dB		
Climate Class	T/ST/N/SN		
Temperature Range	-20°C ~ 20°C (-4°F ~ 68°F)		
Dimensions (D*W*H)	711*460*441mm (28.0*18.1*17.4in.)	711*460*506mm (28.0*18.1*19.9in.)	711*460*571mm (28.0*18.1*22.5in.)
Weight	18.4kg/40.6lbs	19.2kg/42.3lbs	19.6kg/43.2lbs

Mode	E35	E45	E55
Rated Voltage	DC 12V/24V, AC100~240V(using the adapter)		
Rated Power Input	60W		
Capacity	35L/37QT/1.3cu.ft.	45L/48QT/1.6cu.ft.	55L/59QT/2.0cu.ft.
Noise Emission	≤45dB		
Climate Class	T/ST/N/SN		
Temperature Range	-20°C ~ 20°C (-4°F ~ 68°F)		
Dimensions (D*W*H)	647*400*441mm (25.5*15.7*17.4in.)	647*400*506mm (25.5*15.7*19.9in.)	647*400*571mm (25.5*15.7*22.5in.)
Weight	16.1kg/35.5lbs	16.5kg/36.4lbs	17.2kg/37.9lbs

\*Due to product improvement, the technical information might be different from actual information, please refer to the rating label on the product.

### ■ Disposal:

Place the packaging material in the appropriate recycling waste bins wherever possible.



If you wish to finally dispose of the product, ask your local recycling center or specialist dealer for details about how to do this in accordance with the applicable disposal regulations.



## 10. SMART CONTROL - FRIDGE APP INSTRUCTIONS

**First Step:** Turn on the Bluetooth on your smart device; start the APP and click "Search" to find nearby fridges.

**Second Step:** Click fridge icon for Bluetooth pairing (the APP will prompt you to pair the fridge by pressing the set button  on the fridge's control panel when connecting the fridge for the first time). After pairing, the APP will switch to the main interface allowing you to control the fridge.

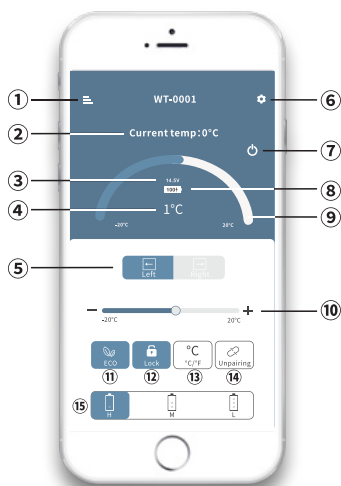

- ① MENU
- ② Current temperature
- ③ Current voltage
- ④ Target temperature
- ⑤ Switch Left/Right compartment
- ⑥ SET
- ⑦ ON/OFF
- ⑧ Current battery
- ⑨⑩ Temperature control
- ⑪ ECO(Energy-saving) / MAX(Fast-cooling)
- ⑫ Lock / Unlock
- ⑬ Celsius / Fahrenheit
- ⑭ Unpairing the device and return to search
- ⑮ Battery protection mode: High/Medium/Low

### Note:

\*Click the lock icon  on the APP to lock/unlock the control panel on the fridge, if locked, the fridge can only be controlled by the APP.

## Downloading the "CAR FRIDGE FREEZER" Application



iOS



Android

Scan the QR code on the left or search for the "CAR FRIDGE FREEZER" APP in the iTunes APP Store (for Apple devices) or Google Store (for Android devices).

Explore more from Buogerv



@bougervofficial



@Bougervofficial



BougeRV

