

Zeus5 AIO Flight Controller Manual

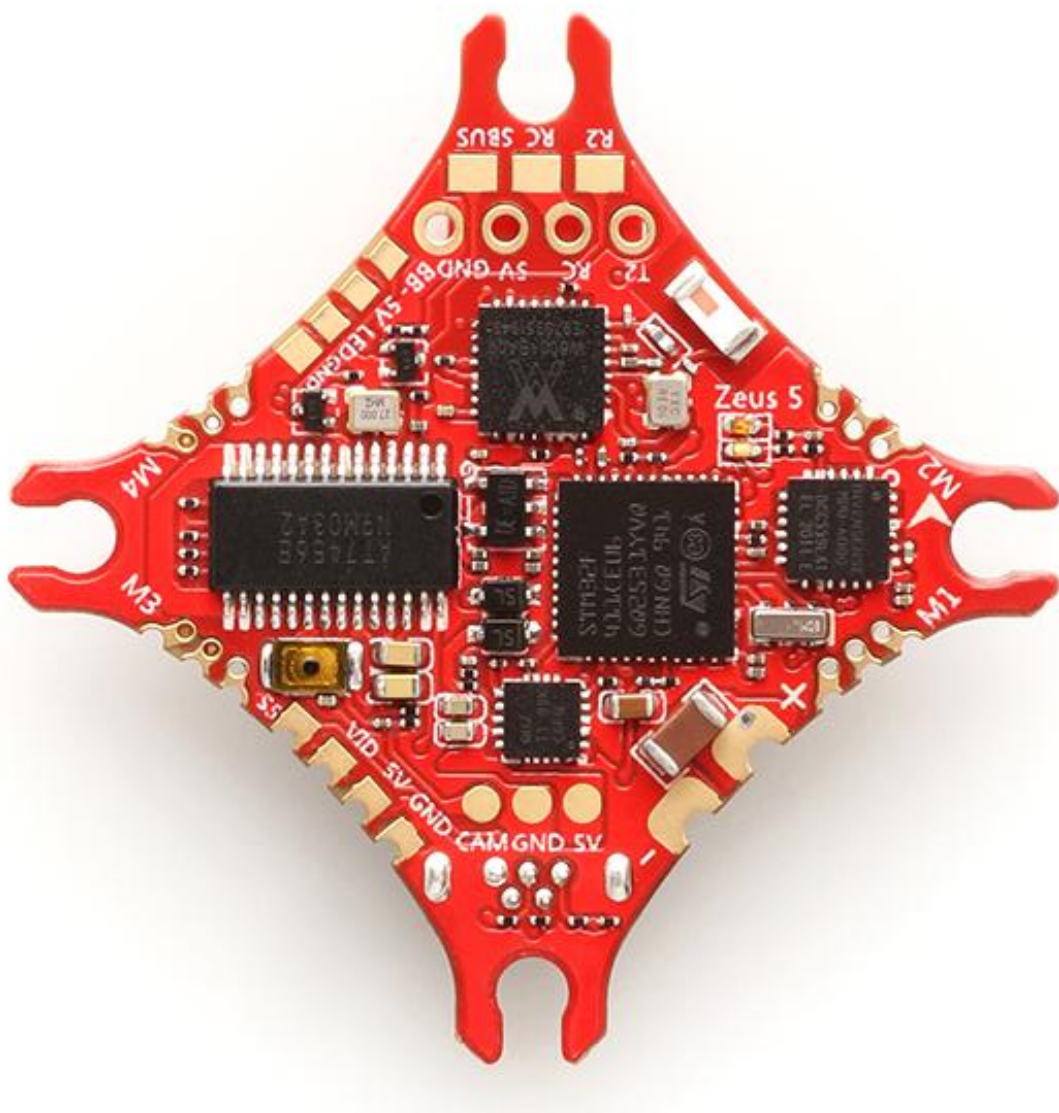



Contents

Product Specifications.....	1
Interface Description.....	2
Check the flight control drive.....	3
Calibration accelerometer.....	4
UART serial port use.....	5
Select aircraft model.....	6
Choose ESC protocol.....	7
Voltage and current parameters setting.....	8
Setting up the receiver.....	9
VTX serial port use. VTX uses OSD smart audio.....	10
Check receiver signal.....	11
Select flight mode startup mode.....	12
OSD settings.....	13
LED settings.....	14
Troubleshooting.....	15

.....

Package Included

Zeus5 AIO Flight Controller*1	Accessory Bag*1
-------------------------------	-----------------

1.Product Specifications



Product parameters	
Model	Zeus5 AIO Flight Controller
Weight	4.2g
Input Voltage	1-2S
Usage	for 65mm-120mm Frame Kit
Installing Hole	25.5x25.5mm/M2
Dimensions	41.5.x41.5mm
FC Firmware	BF HGLRCF411(HGLR)
CPU	STM32F411
MPU	MPU6000
BEC	5V/1A
BlackBox	NO
UARTS	2
ESC Firmware	BL_S
Current Sensor	not support
Constant Current	5A

2.Interface Description

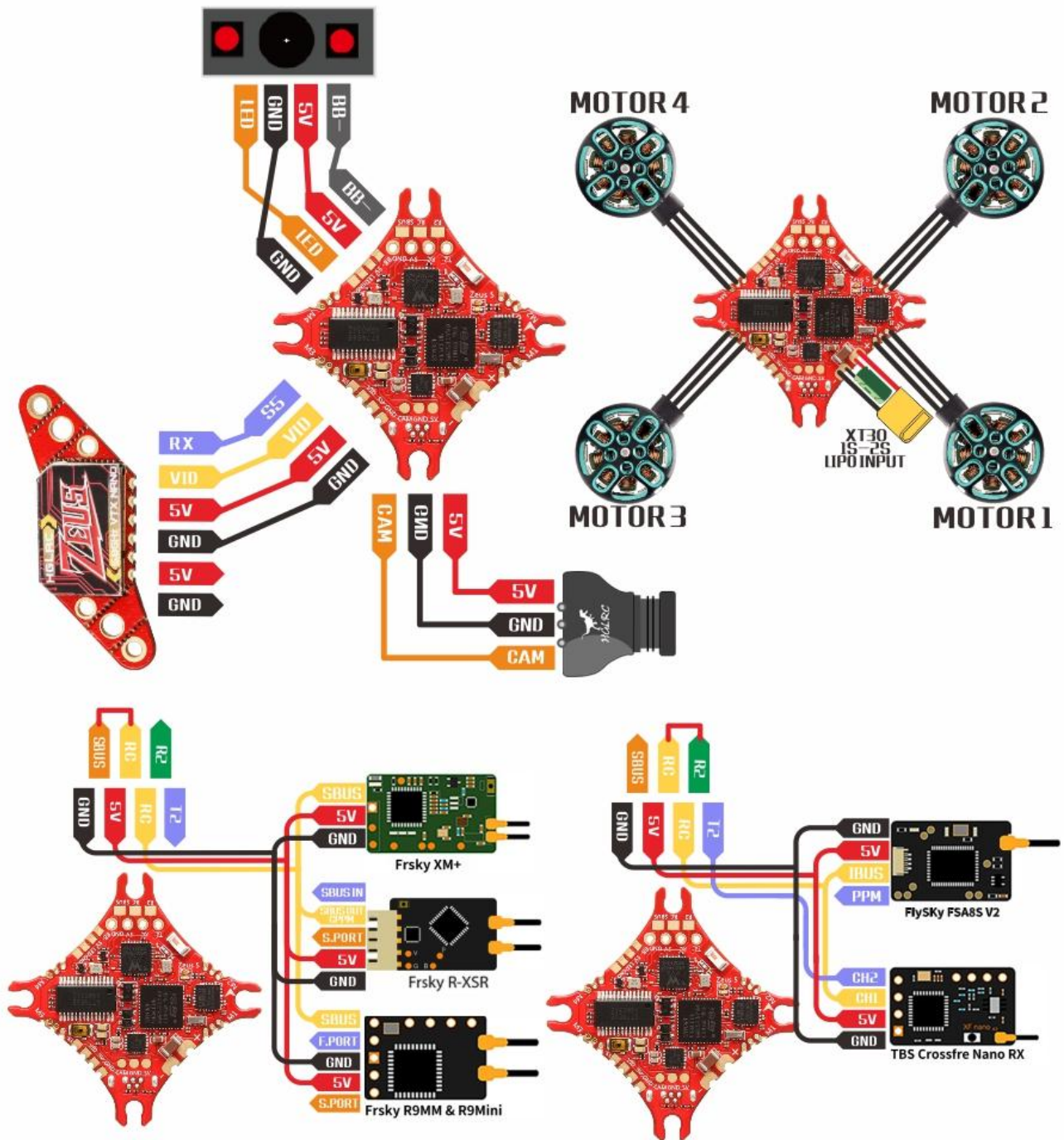

3. Check the flight control drive

1. Long Press BOOT buttons.connect USB.The system automatically install the driver



2.Driver cannot be installed, please download ImpulseRC_Driver_Fixer

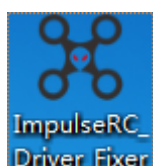

3.Double-click on the run(Plug in the flight controller to automatically install the driver)

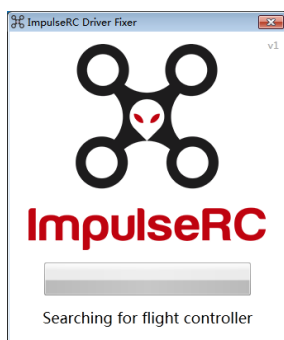

4.open betaflyght configurator , enter DFU mode

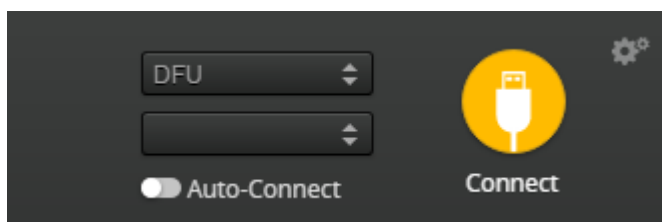

5.Click  Select firmware version

Show unstable releases

HGLRCF411 ▼

4.2.4 - 20-10-2020 23:04 ▼

No reboot sequence

Flash on connect

Full chip erase

Manual baud rate 115200 ▼

6. Click **Load Firmware [Online]** Load firmware. **Flash Firmware** Waiting for completion **Erasing ...** It will be prompted upon completion.

Programming: SUCCESSFUL

7. open betaflyght configurator . Controller plugged into the computer. Betaflight Automatically assigned port. click "Connect" Enter setup interface (Different computer COM)

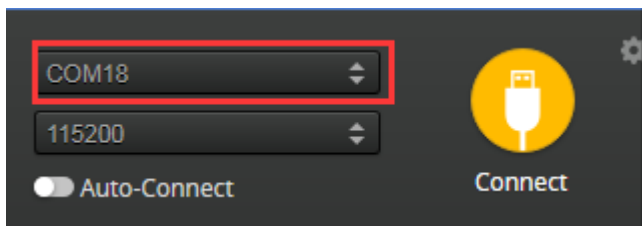

4. Calibration accelerometer

1. Put the aircraft horizontal and click “Reset Z axis”

Click again **Calibrate Accelerometer**

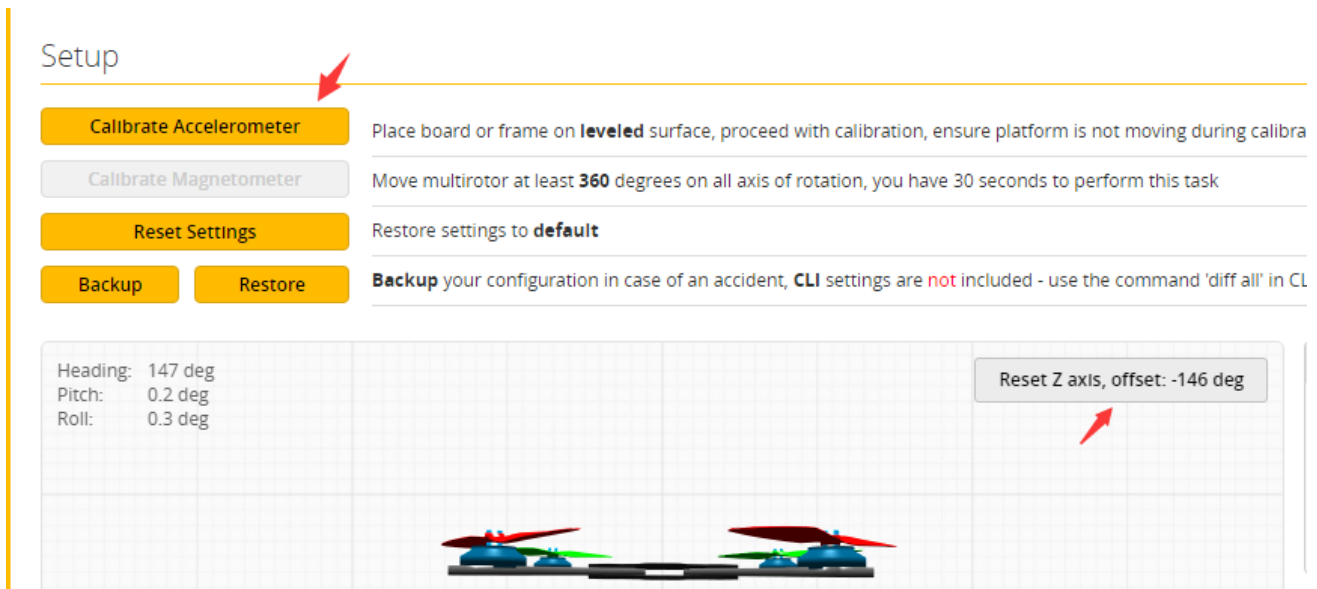

5. UART serial port use

1. UART1 uses WIFI

Open WIFI CLI command:

```
“resource PINIO 1 B10
serial 0 1 115200 57600 0 115200
set pinio_config = 129,1,1,1
set pinio_box = 0,255,255,255
save”
```

2. UART2 uses receiver

S5 is a soft serial port, dedicated to video transmission (VTX) FM

CLI command of soft serial port:

```
"resource MOTOR 5 none  
resource SERIAL_TX 11 B03  
SAVE"
```

6. Select aircraft model

1. Click  Configuration Select model

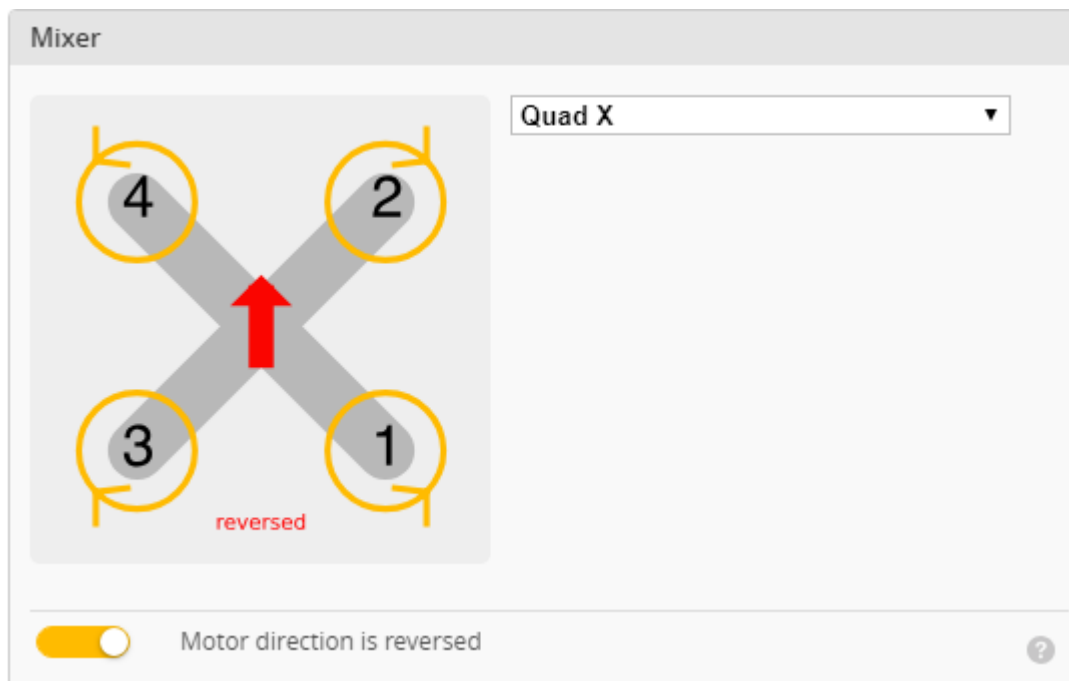

2. Click  **Motors** Click “**I understand the risks**” Push Master to check motor steering “**Master**” Steering can be changed at [BLHeliSuite](#)

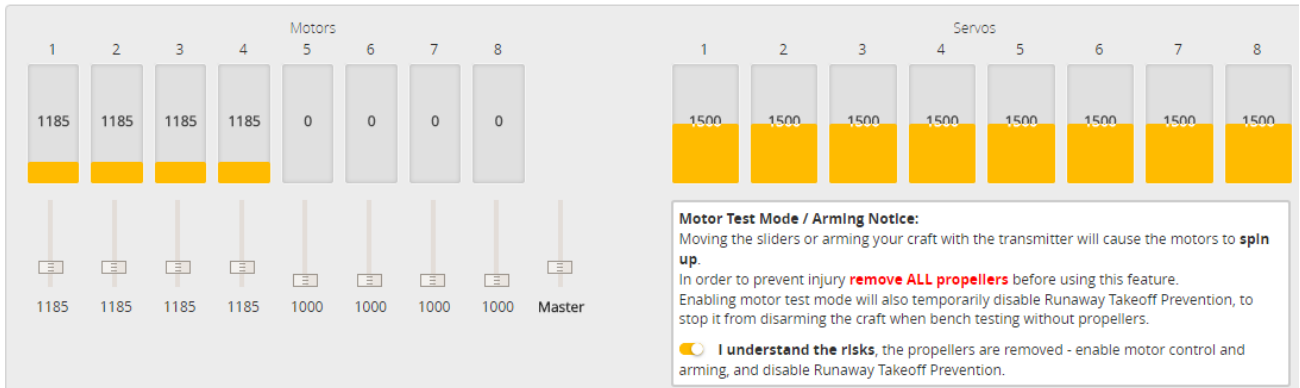

The screenshot shows the BLHeliSuite interface for configuring motors and servos. On the left, under the 'Motors' tab, there are eight motor channels. Channels 1-4 are set to 1185, and channels 5-8 are set to 0. Below the motor channels are sliders and a 'Master' button. On the right, under the 'Servos' tab, there are eight servo channels, all set to 1500. A 'Motor Test Mode / Arming Notice' box is visible, containing the following text: 'Moving the sliders or arming your craft with the transmitter will cause the motors to spin up. In order to prevent injury remove ALL propellers before using this feature. Enabling motor test mode will also temporarily disable Runaway Takeoff Prevention, to stop it from disarming the craft when bench testing without propellers. I understand the risks, the propellers are removed - enable motor control and arming, and disable Runaway Takeoff Prevention.'

7. Choose ESC protocol

1. Choose the right ESC protocol, the optional universal protocol DSHOT600.

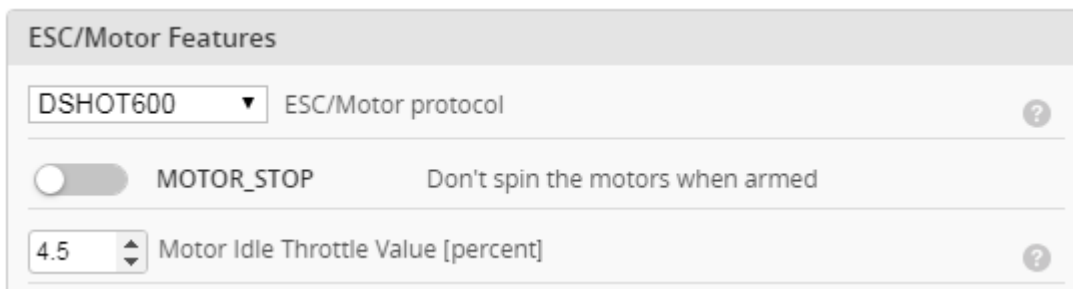

The screenshot shows the 'ESC/Motor Features' configuration page. It includes a dropdown menu for 'ESC/Motor protocol' set to 'DSHOT600', a toggle switch for 'MOTOR_STOP' (labeled 'Don't spin the motors when armed'), and a numeric input field for 'Motor Idle Throttle Value [percent]' set to 4.5.

8. Voltage and current parameters setting

1. Click **Power & Battery** Setting parameters

Power & Battery

Battery	
Onboard ADC	Voltage Meter Source
Onboard ADC	Current Meter Source
3.3	Minimum Cell Voltage
4.3	Maximum Cell Voltage
3.5	Warning Cell Voltage
0	Capacity (mAh)

Voltage Meter	
Battery	0 V
110	Scale
10	Divider Value
1	Multiplier Value

9. Setting up the receiver

1. Receiver connection diagram

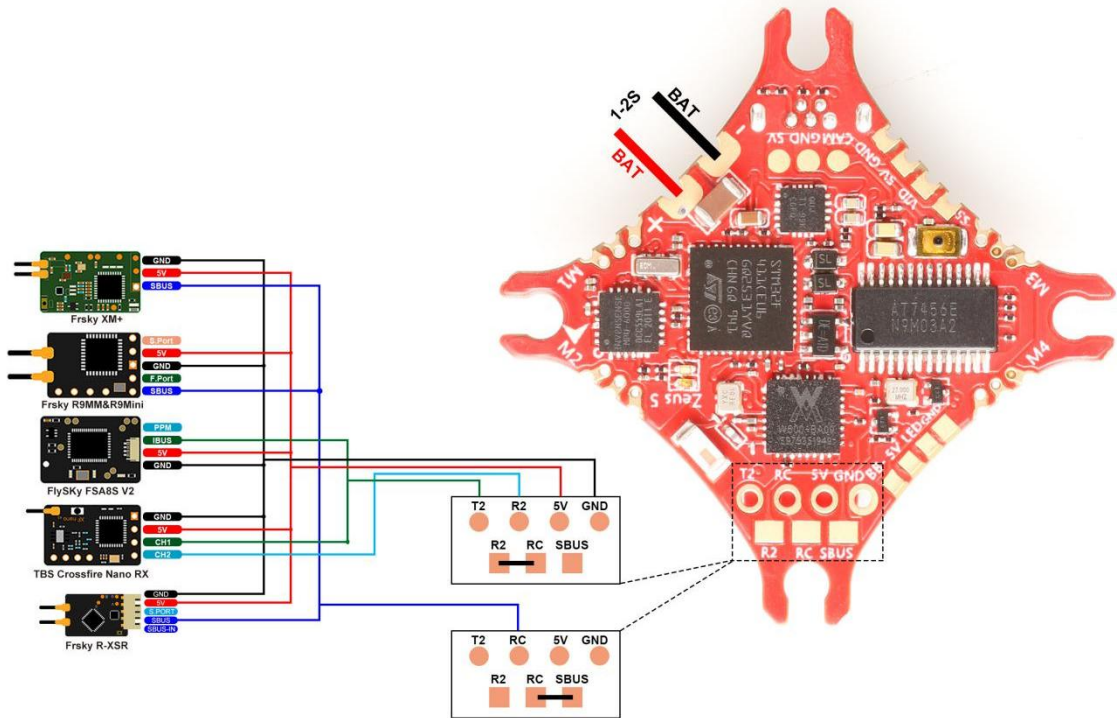

2. Click have found “UART2” Open the receiver serial port

Ports

WIKI

Note: not all combinations are valid. When the flight controller firmware detects this the serial port configuration will be reset.
Note: Do **NOT** disable MSP on the first serial port unless you know what you are doing. You may have to refresh and erase your configuration if you do.

WARNING: The VTX table has not been set up correctly and without it VTX control will not be possible. Please set up the VTX table in Video Transmitter tab.

Identifier	Configuration/MSP	Serial Rx	Telemetry Output	Sensor Input	Peripherals
USB VCP	<input checked="" type="checkbox"/> 115200	<input type="checkbox"/>	Disabled AUTO	Disabled AUTO	Disabled AUTO
UART1	<input checked="" type="checkbox"/> 115200	<input type="checkbox"/>	Disabled AUTO	Disabled AUTO	Disabled AUTO
UART2	<input type="checkbox"/> 115200	<input checked="" type="checkbox"/>	Disabled AUTO	Disabled AUTO	Disabled AUTO
SOFTSERIAL1	<input type="checkbox"/> 115200	<input type="checkbox"/>	Disabled AUTO	Disabled AUTO	VTX (IRC Tran) AUTO

10.VTX serial port use. VTX uses OSD smart audio

1.VTX connection diagram

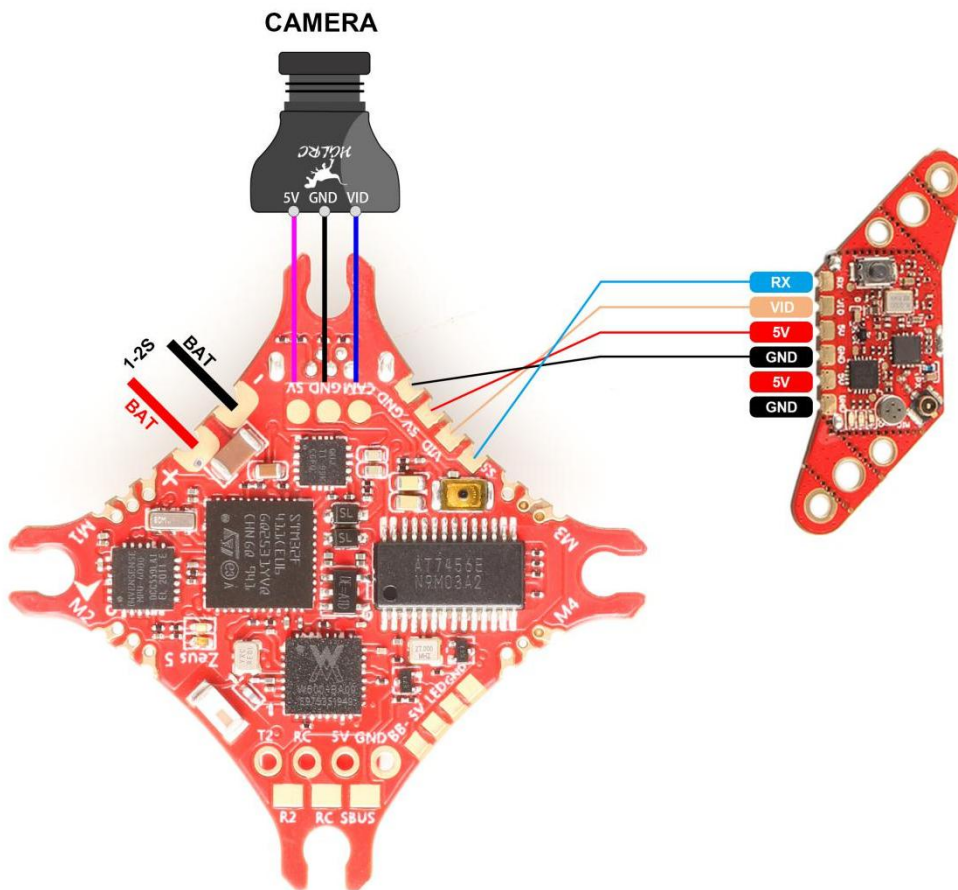

2.VTX serial port opens. The protocol is selected according to its own VTX protocol.

Ports

WIKI

Note: not all combinations are valid. When the flight controller firmware detects this the serial port configuration will be reset.
Note: Do **NOT** disable MSP on the first serial port unless you know what you are doing. You may have to reflash and erase your configuration if you do.

WARNING: The VTX table has not been set up correctly and without it VTX control will not be possible. Please set up the VTX table in Video Transmitter tab.

Identifier	Configuration/MSP	Serial Rx	Telemetry Output	Sensor Input	Peripherals
USB VCP	<input checked="" type="checkbox"/> 115200	<input type="checkbox"/>	Disabled AUTO	Disabled AUTO	Disabled AUTO
UART1	<input checked="" type="checkbox"/> 115200	<input type="checkbox"/>	Disabled AUTO	Disabled AUTO	Disabled AUTO
UART2	<input type="checkbox"/> 115200	<input checked="" type="checkbox"/>	Disabled AUTO	Disabled AUTO	Disabled AUTO
SOFTSERIAL1	<input type="checkbox"/> 115200	<input type="checkbox"/>	Disabled AUTO	Disabled AUTO	VTX (IRC Tran AUTO

3. Use OSD to adjust VTX

which displays information like battery voltage and mAh consumed while you fly. In addition, the Betaflight OSD can be used to configure the quadcopter, making in-field adjustments and tuning more convenient.

MODE2

MODE1

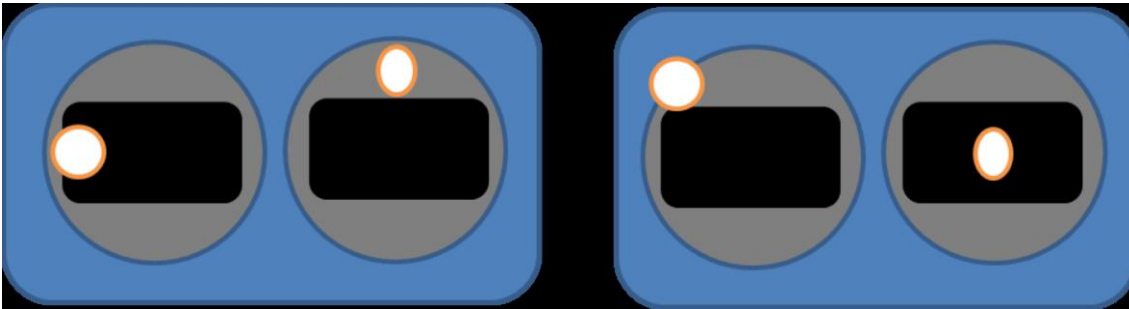

The graphics above show the stick command to bring up the OSD menu. The stick command is: throttle centered, yaw left, pitch forward. The exact stick command therefore depends on which mode your transmitter sticks are in.

In the OSD menu, use pitch up/down to move the cursor between menu items. When a menu option has a > symbol to the right of it, this indicates that it contains a sub-menu. Roll-right will enter the sub-menu. For example, in the screen to the right, moving the cursor to “Features” and then moving the roll stick to the right will enter the “Features” sub-menu.

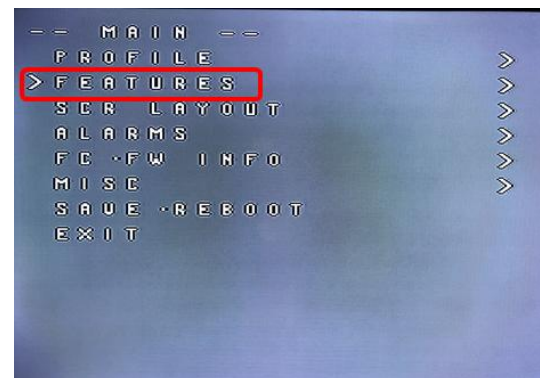

If you are using a video transmitter that supports remote configuration, enter the “Features” menu to configure the vTX. From there, enter either “VTX SA” if you are using SmartAudio (TBS Unify) or “VTX TR” if you are using IRC Tramp Telemetry.

To adjust PIDs, rates, and other tuning-related parameters, enter the “Profile” sub-menu.

In the “Scr Layout” sub-menu, you can move the OSD elements (like battery voltage, mAh, and so forth) around on the screen.

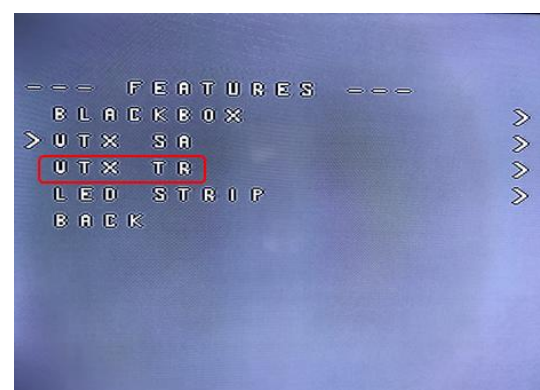

The “Alarms” sub-menu lets you control when the OSD will try to alert you that battery voltage is too low or mAh consumed is too high.

When a parameter can be modified, the parameter's current value will be shown on the right-hand side of the screen. In this case, roll left/right will adjust the parameter up and down.

The screen to the right shows the current vTX settings. From here, you can change the frequency band, channel, and power level of the video transmitter. After making the changes, move the cursor to "Set" and press roll-right to confirm the settings.

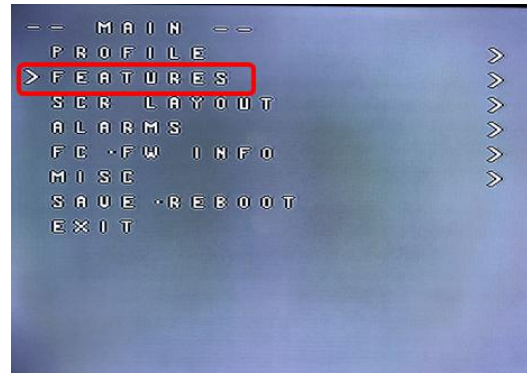

11. Check receiver signal

1. Click  Receiver Check the remote control output signal

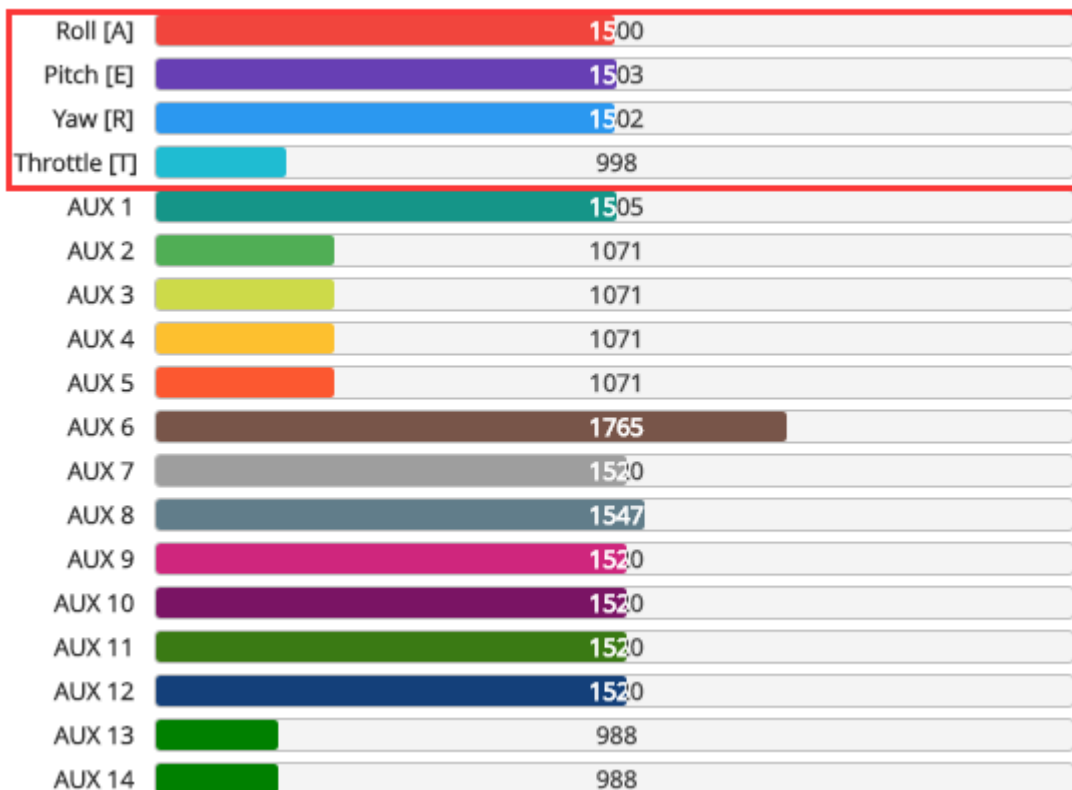

12. Select flight mode startup mode

1. Click **Modes** set up the function of remote control switch across the channel (below are for reference only)

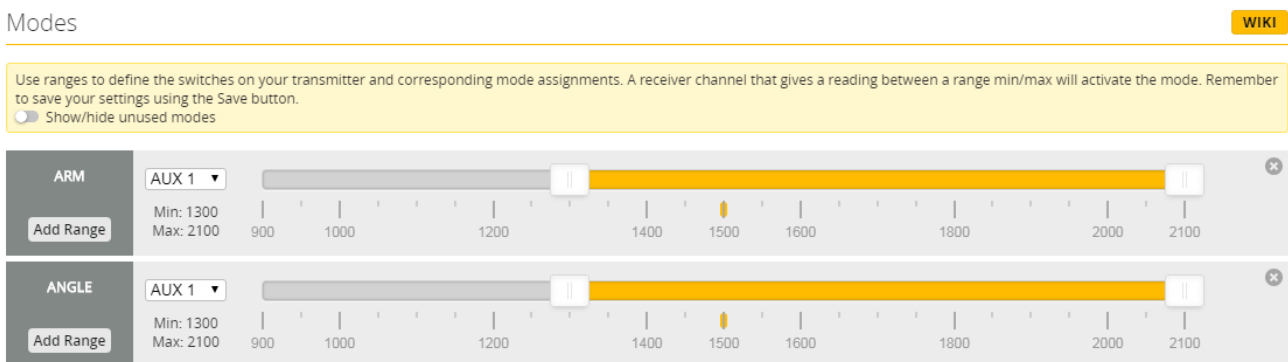

13. OSD settings

1. Click **OSD** the OSD Settings, according to the need to choose, drag the OSD schematic diagram of the parameters can be adjusted.

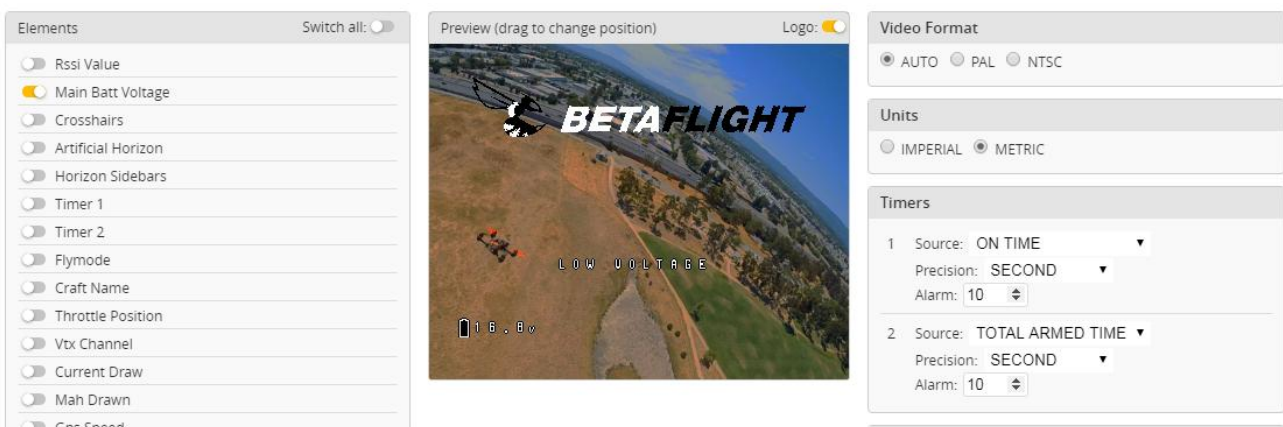

14.LED settings

1. Click  Configuration Turn on LED support

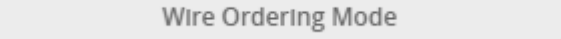

2. Click  LED Strip .Click  set according to need

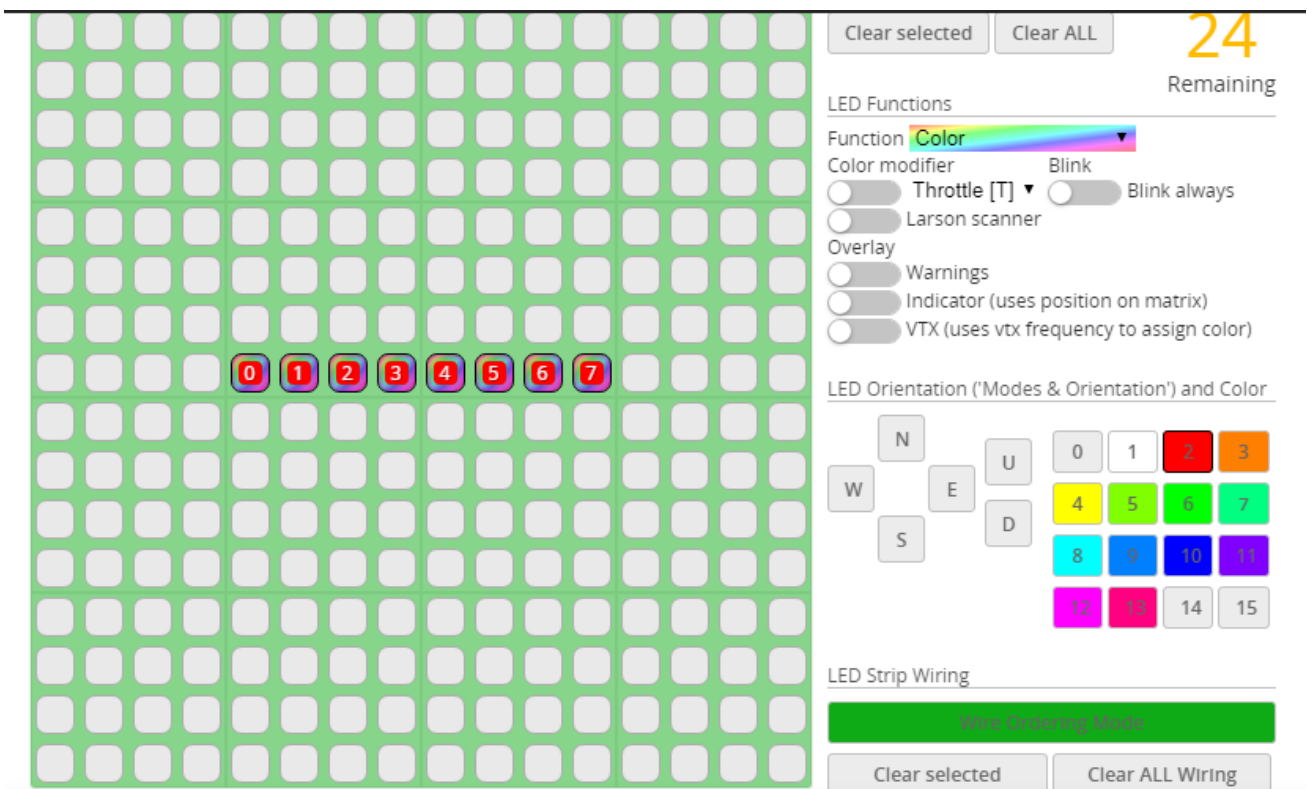

Clear selected Clear ALL **24** Remaining

LED Functions

Function **Color**

Color modifier Blink

Throttle [T] Blink always

Larson scanner

Overlay

Warnings

Indicator (uses position on matrix)

VTX (uses vtx frequency to assign color)

LED Orientation ('Modes & Orientation') and Color

N	U	0	1	2	3
W	E	4	5	6	7
S	D	8	9	10	11
		12	13	14	15

LED Strip Wiring

Wire Ordering Mode

Clear selected Clear ALL Wiring

15. Troubleshooting

Warning:

Please read the cautions as follows, otherwise stability of your flight controller cannot be ensured, your flight controller will even get damaged.

- Keep focus on the polarity. Check carefully before power supply.
- Cut off the power when you connect, plug and pull anything.
- The refresh rate of PID and Gyroscope is up to 4K/4K.

after sales question:

1. After receiving the goods, it is found that the product can not be used normally. If the return to the factory is a quality problem, the repair service will be provided free of charge.
2. If the product is damaged due to improper operation, the repair service may be provided under the condition that the inspection can be repaired.
3. For domestic customers, please contact the after-sales service personnel. For overseas customers, please contact the official website for after-sales service.

Product daily problems:

1.OSD garbled:

If you find garbled characters, please open Betaflight, click “OSD” .and click “Font Manager” clicks on “Upload Font” to update

1. When plugged in the battery, the aircraft does not pass the self-test

without "BBB" sound. There is only one sound.

Please check if the ESC agreement is correct

3.The spin of the aircraft keeps spinning

1. Please check if the propeller is correct
2. Please check if the motor direction is correct