

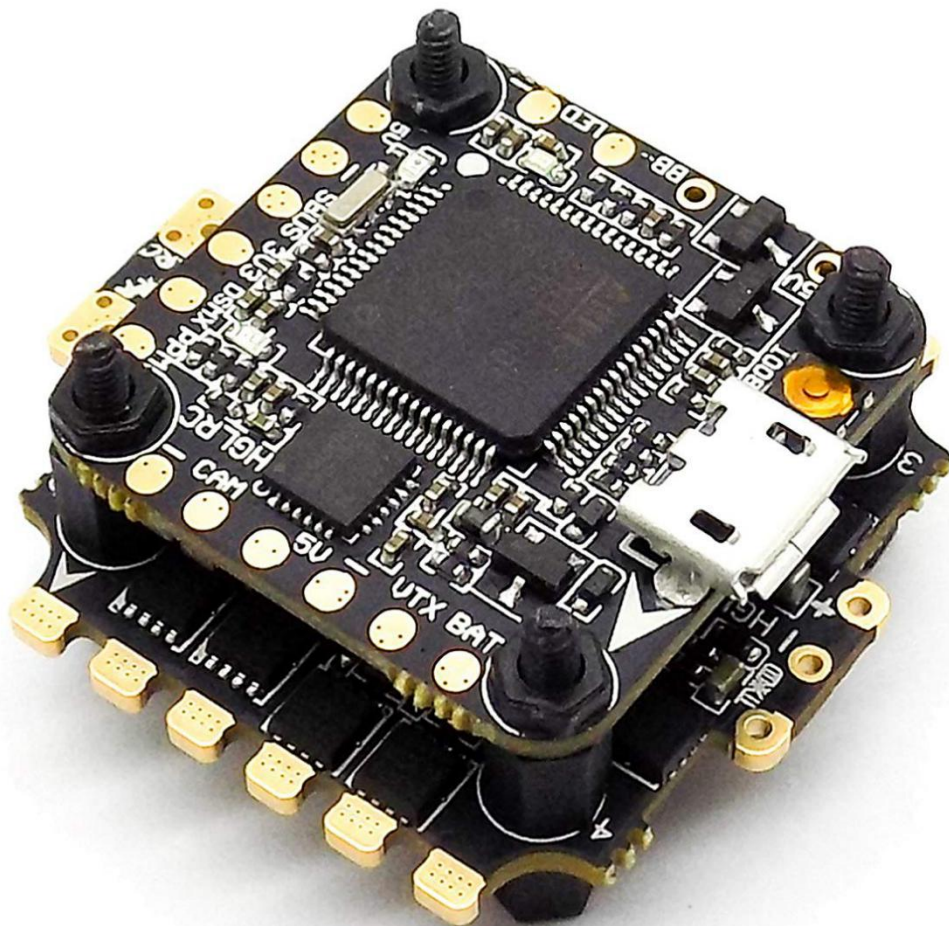

HGLRC F440 FC

Manual



Contents

Product Specifications.....	1
Interface Description.....	2
Check the flight control drive.....	3
Calibration accelerometer.....	4
URAT serial port use.....	5
Select aircraft model.....	6
Choose ESC/Motor protocol.....	7
Select ESC telemetry.....	8
Voltage and current parameters setting.....	9
Setting up the receiver.....	10
VTX serial port use. VTX uses OSD smart audio.....	11
GPS parameters setting.....	12
Check receiver signal.....	13
Select flight mode startup mode.....	14
OSD settings.....	15
LED settings.....	16
Troubleshooting.....	17

.....

Package Included

HGLRC F440 FC*1	Accessory Bag*1
-----------------	-----------------

1. Product Specifications

Product parameters	
Model	HGLRC F440 Flight Control
Weight	8.9g
Usage	for 110mm-1000mm Frame Kit
MPU	MPU6000-SPI
CPU	STM32F405RGT6, 8K
Black Box	Flash memory 16M
Support receiver	SBUS .PPM .DSMX
Input Voltage	2-4S Lipo
BEC Output	5V@3A
Size	32*34mm board, 20mm mounting holes

2. Interface Description

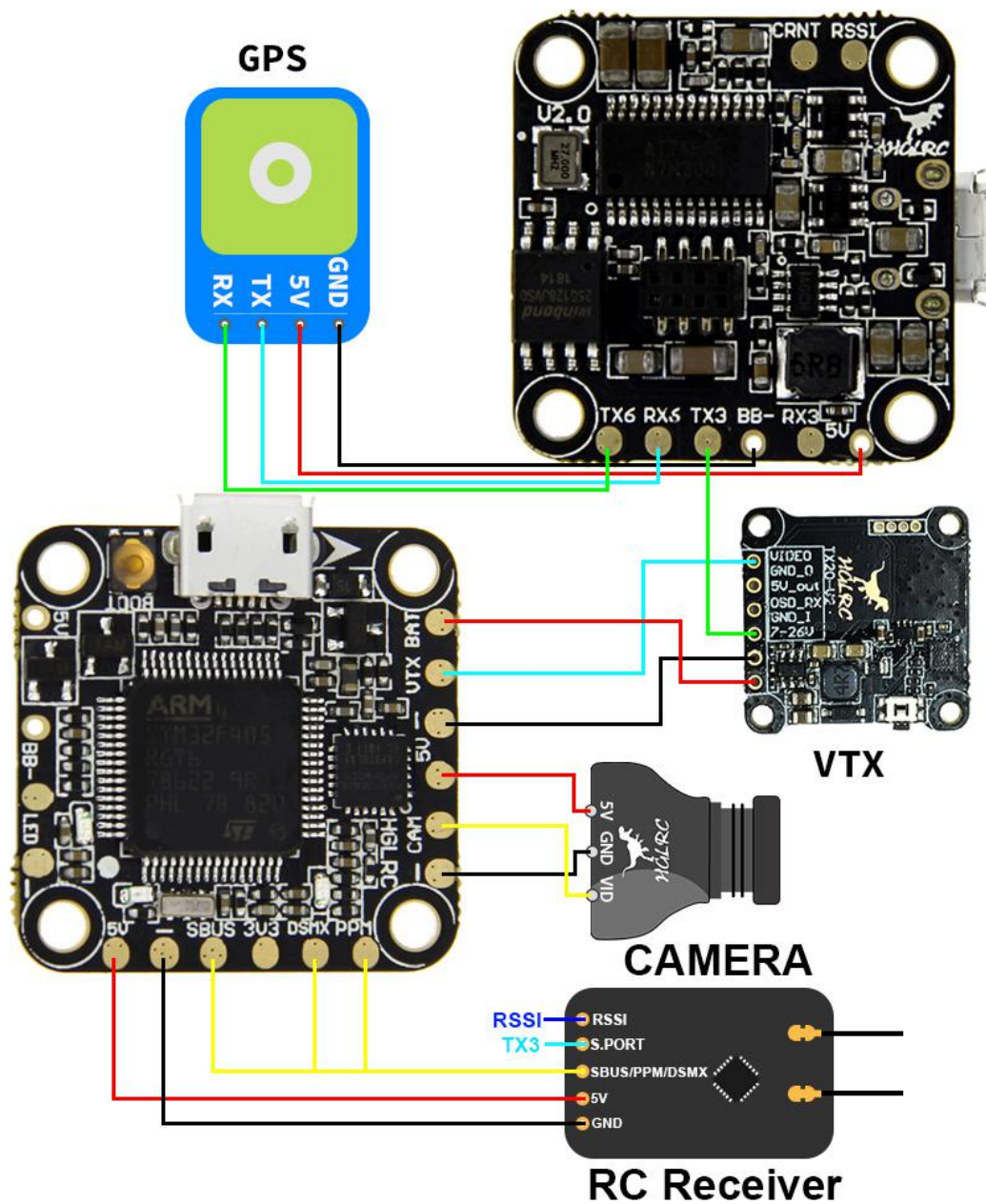

3. Check the flight control drive

1. Long Press BOOT buttons.connect USB.The system automatically install the driver



2.Driver cannot be installed, please download ImpulseRC_Driver_Fixer



3.Double-click on the run(Plug in the flight controller to automatically install the driver)

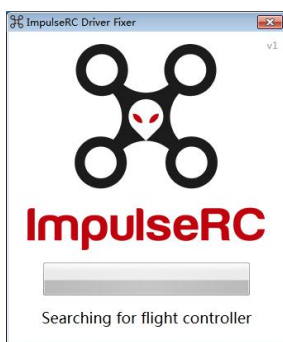

4.open betaflyght configurator , enter DFU mode

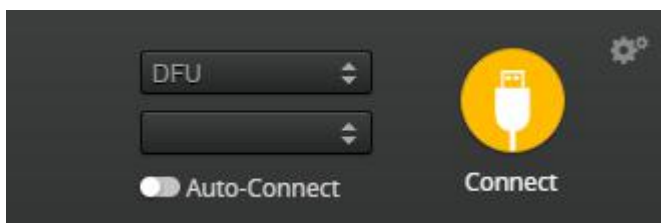

5. Click **Firmware Flasher** Select firmware version

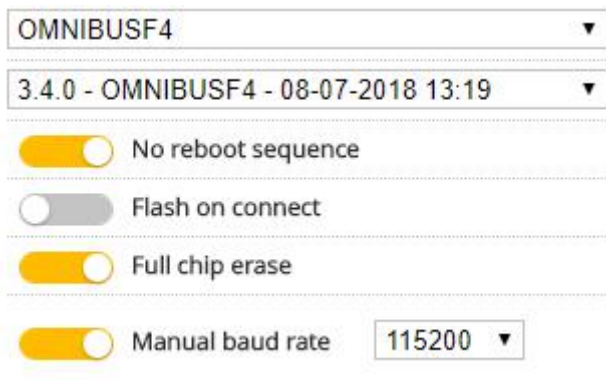

6. Click **Load Firmware [Online]** Load firmware. **Flash Firmware** Waiting for completion **Erasing ...** It will be prompted upon completion. **Programming: SUCCESSFUL**

7. open betaflyght configurator  . Controller plugged into the computer. Betaflight Automatically assigned port, click “Connect” Enter setup interface (Different computer COM)

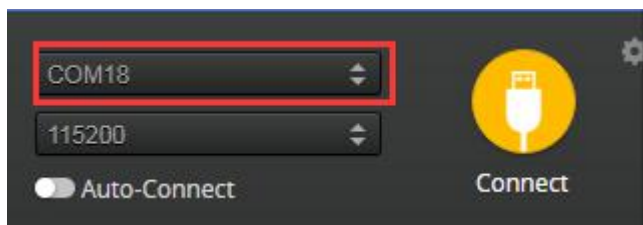

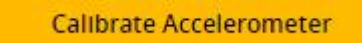

4. Calibration accelerometer

1. Put the aircraft horizontal and click “Reset Z axis”

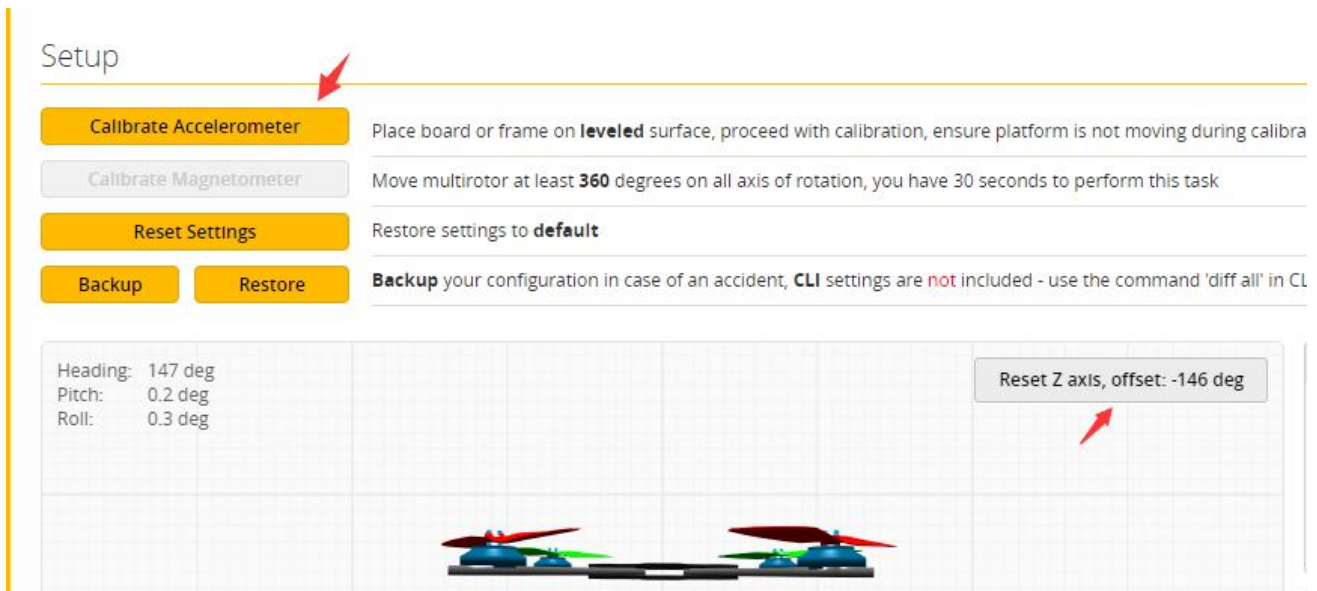
Click again 

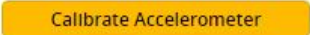

Setup

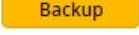
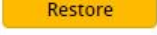
	Place board or frame on leveled surface, proceed with calibration, ensure platform is not moving during calibration
	Move multirotor at least 360 degrees on all axis of rotation, you have 30 seconds to perform this task
	Restore settings to default
 	Backup your configuration in case of an accident, CLI settings are not included - use the command 'diff all' in CLI

Heading: 147 deg
Pitch: 0.2 deg
Roll: 0.3 deg

Reset Z axis, offset: -146 deg

5.URAT serial port use

URAT1 uses the receiver

UART3 can use GPS/VTX

URAT6 can use ESC telemetry / GPS

6.Select aircraft model

1.Click  Configuration Select model

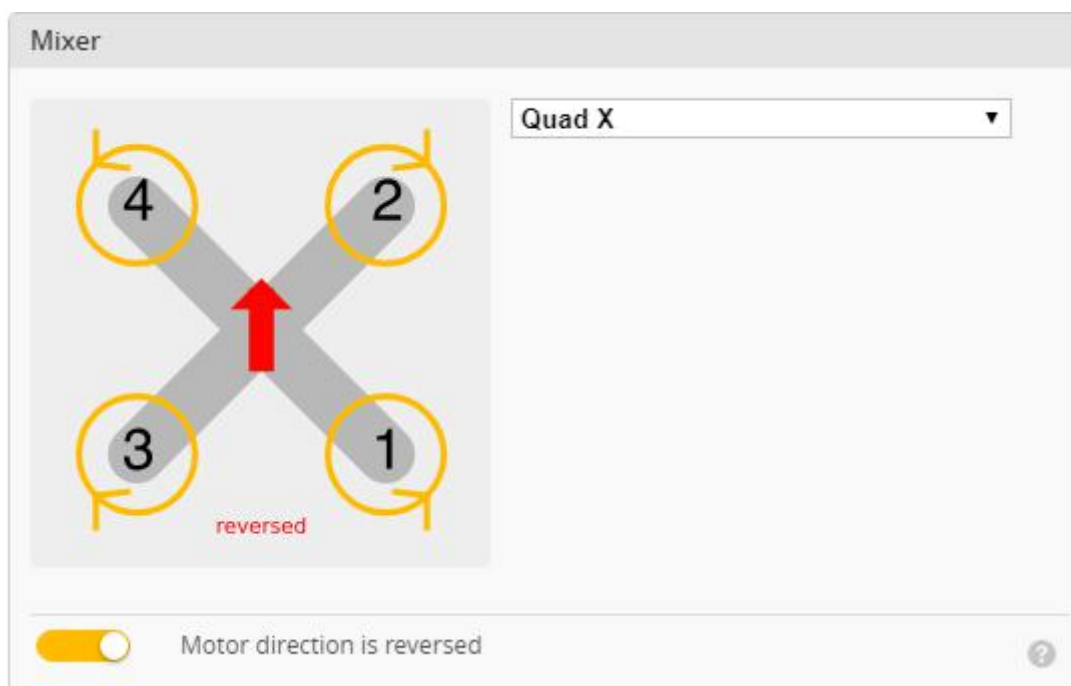

2. Click  **Motors** Click “**I understand the risks**” Push Master to check motor steering “**Master**” Steering can be changed at [BLHeliSuite](#)

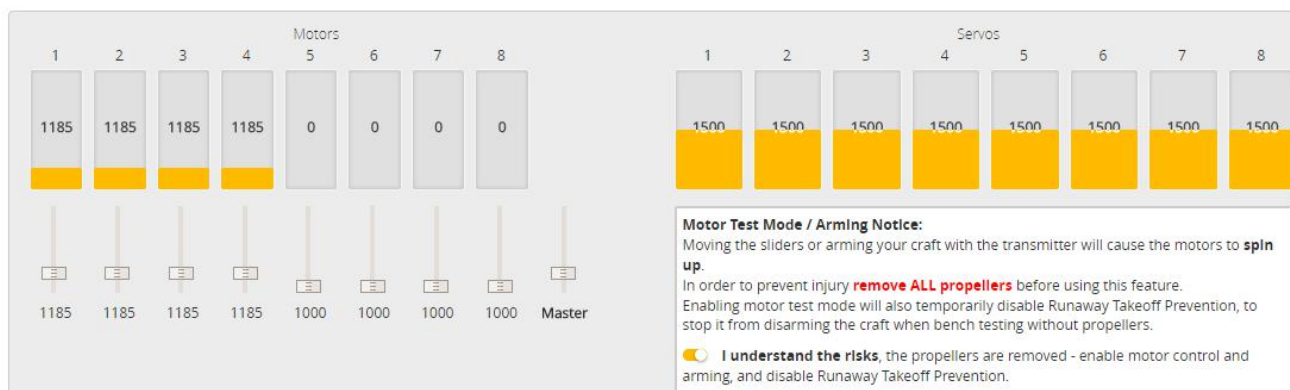

7. Choose ESC/Motor protocol

1. Choose the correct ESC / Motor protocol, optional universal protocol DSHOT600. For F440, DSHOT1200 is recommended.

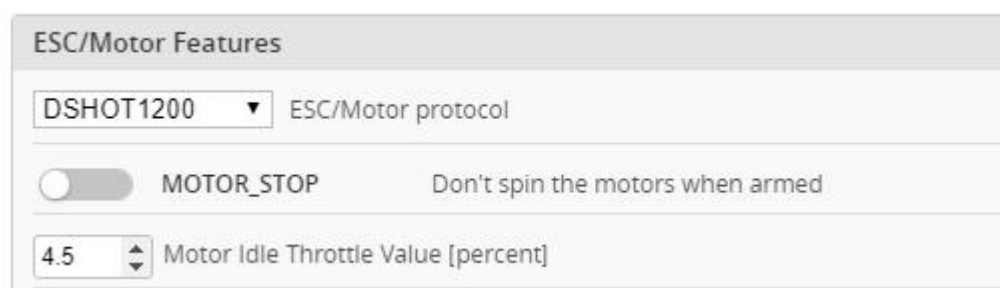

8. Turn on ESC telemetry

1. Open ESC telemetry serial port. TX on the ESC needs to be connected to the RX6 on the flight controller to use the ESC telemetry

Identifier	Configuration/MSP	Serial Rx	Telemetry Output	Sensor Input	Peripherals
USB VCP	<input checked="" type="checkbox"/> 115200	<input type="checkbox"/>	Disabled AUTO	Disabled AUTO	Disabled AUTO
UART1	<input type="checkbox"/> 115200	<input checked="" type="checkbox"/>	Disabled AUTO	Disabled AUTO	Disabled AUTO
UART3	<input type="checkbox"/> 115200	<input type="checkbox"/>	Disabled AUTO	Disabled AUTO	Disabled AUTO
UART6	<input type="checkbox"/> 115200	<input type="checkbox"/>	Disabled AUTO	ESC AUTO	Disabled AUTO

2. Use KISS/BLHeli_32 ESC telemetry as sensor.



3. View telemetry data on OSD

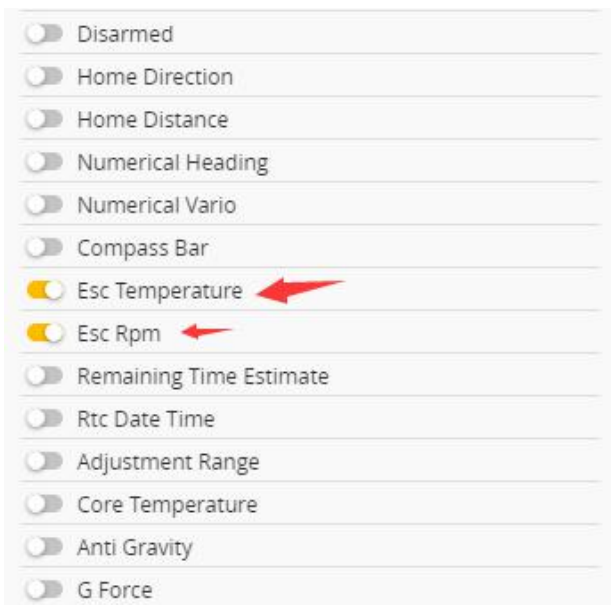

9. Voltage and current parameters setting

1. Click  Power & Battery Setting parameters

Battery	
Onboard ADC	Voltage Meter Source
Onboard ADC	Current Meter Source
3.3	Minimum Cell Voltage
4.3	Maximum Cell Voltage
3.5	Warning Cell Voltage
0	Capacity (mAh)

Voltage Meter	
Battery	0 V
110	Scale
10	Divider Value
1	Multiplier Value

Amperage Meter	
Battery	0.00 A
179	Scale [1/10th mV/A]
0	Offset [mA]

10. Setting up the receiver

1.Receiver connection diagram

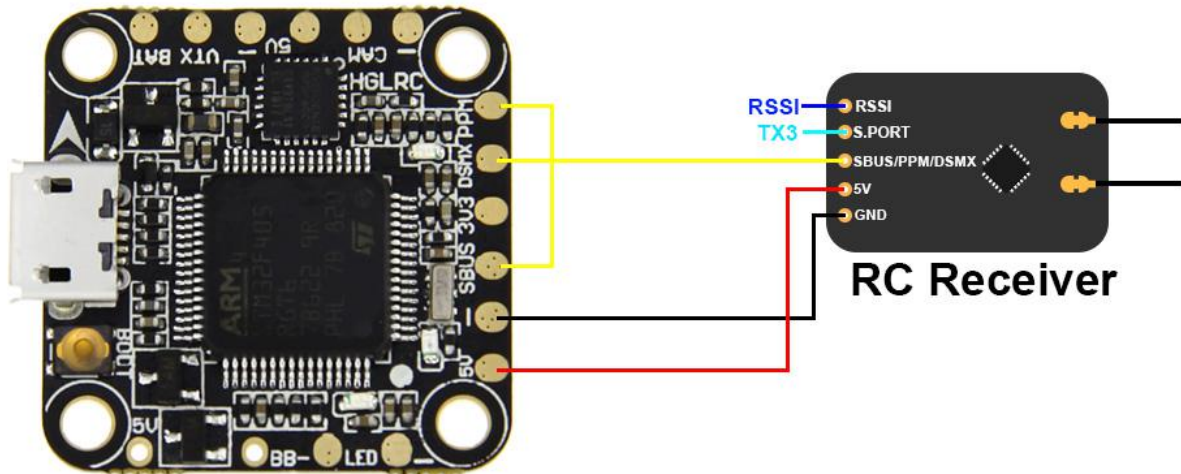

2. Click  have found “UART1” Open the receiver serial port

Identifier	Configuration/MSP	Serial Rx	Telemetry Output	Sensor Input	Peripherals
USB VCP	<input checked="" type="checkbox"/> 115200 ▾	<input type="checkbox"/>	Disabled ▾ AUTO ▾	Disabled ▾ AUTO ▾	Disabled ▾ AUTO ▾
UART1	<input type="checkbox"/> 115200 ▾	<input checked="" type="checkbox"/>	Disabled ▾ AUTO ▾	Disabled ▾ AUTO ▾	Disabled ▾ AUTO ▾
UART3	<input type="checkbox"/> 115200 ▾	<input type="checkbox"/>	Disabled ▾ AUTO ▾	Disabled ▾ AUTO ▾	IRC Tramp ▾ AUTO ▾
UART6	<input type="checkbox"/> 115200 ▾	<input type="checkbox"/>	Disabled ▾ AUTO ▾	GPS ▾ 9600 ▾	Disabled ▾ AUTO ▾

3. Set the SBUS receiver

Receiver

Serial-based receiver (SPEKSAT, 5 ▼) Receiver Mode

Note: Remember to configure a Serial Port (via Ports tab) and choose a Serial Receiver Provider when using RX_SERIAL feature.

SBUS ▼ Serial Receiver Provider

4. Set the PPM receiver

Receiver

PPM RX input ▼ Receiver Mode

5. Set the DSMX receiver

Receiver

Serial-based receiver (SPEKSAT, 5 ▼) Receiver Mode

Note: Remember to configure a Serial Port (via Ports tab) and choose a Serial Receiver Provider when using RX_SERIAL feature.

SPEKTRUM2048 ▼ Serial Receiver Provider

6. Turn on the receiver telemetry serial port Function on

Identifier	Configuration/MSP	Serial Rx	Telemetry Output	Sensor Input	Peripherals
USB VCP	<input checked="" type="checkbox"/> 115200 ▼	<input type="checkbox"/>	Disabled ▼ AUTO ▼	Disabled ▼ AUTO ▼	Disabled ▼ AUTO ▼
UART1	<input type="checkbox"/> 115200 ▼	<input checked="" type="checkbox"/>	Disabled ▼ AUTO ▼	Disabled ▼ AUTO ▼	Disabled ▼ AUTO ▼
UART3	<input type="checkbox"/> 115200 ▼	<input type="checkbox"/>	SmartPort ▼ AUTO ▼	Disabled ▼ AUTO ▼	Disabled ▼ AUTO ▼
UART6	<input type="checkbox"/> 115200 ▼	<input type="checkbox"/>	Disabled ▼ AUTO ▼	Disabled ▼ AUTO ▼	Disabled ▼ AUTO ▼

TELEMETRY Telemetry output

11.VTX serial port use. VTX uses OSD smart audio

1.VTX connection diagram

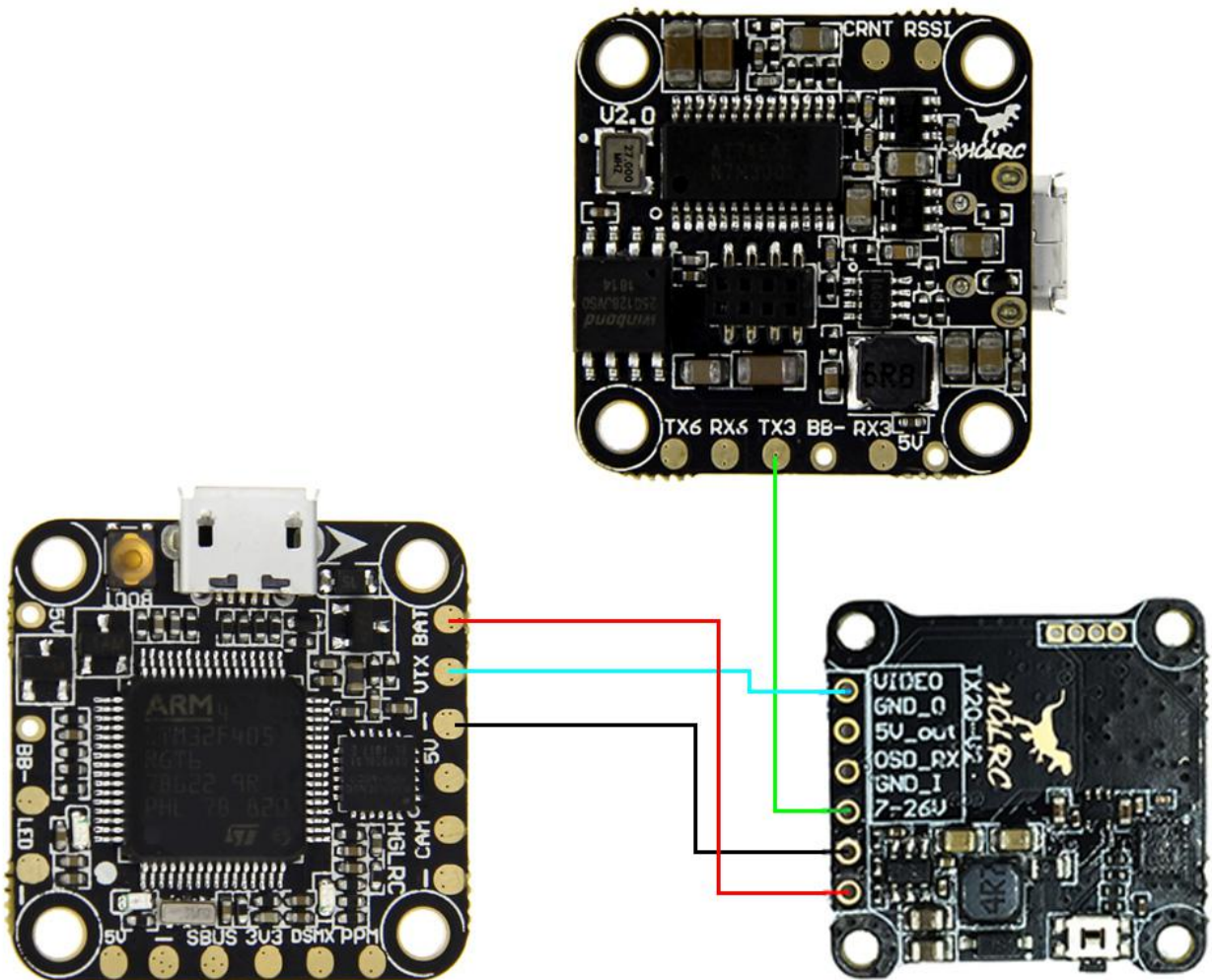

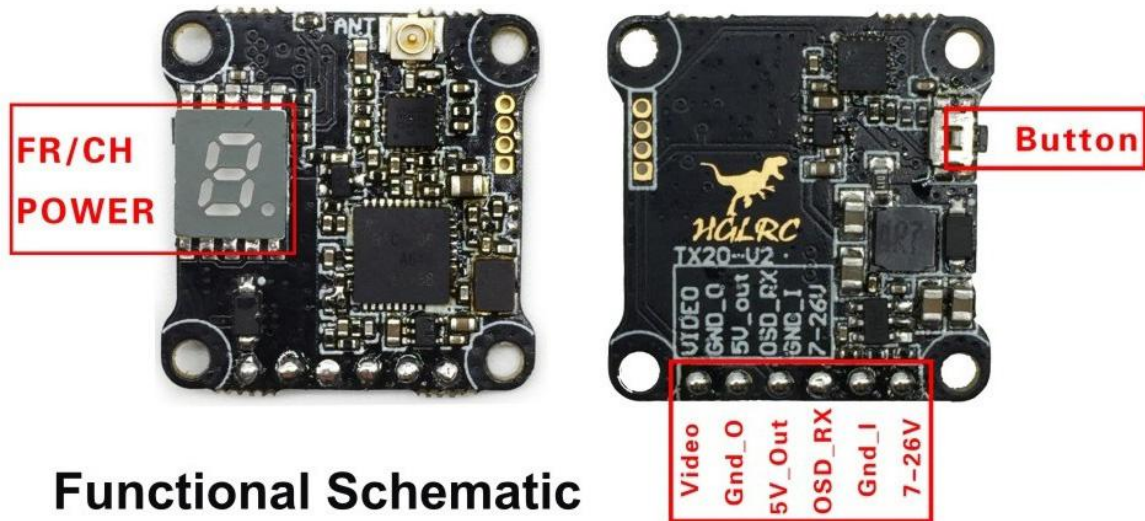

Functional Schematic

Frequency and power control method:

- Betaflight firmware;
- Button frequency control: Short press once to change channel number CH (CH1-CH8), long press for 2 seconds and then short press to change frequency group FR (A-F);
- Button power control: Long press button for 6 seconds and then short press button to change power level 25mW / 100mW / 200mW / 350mW; (please see details as the picture shown on the right: Power switching instruction)
- Power instructions: (check details below)

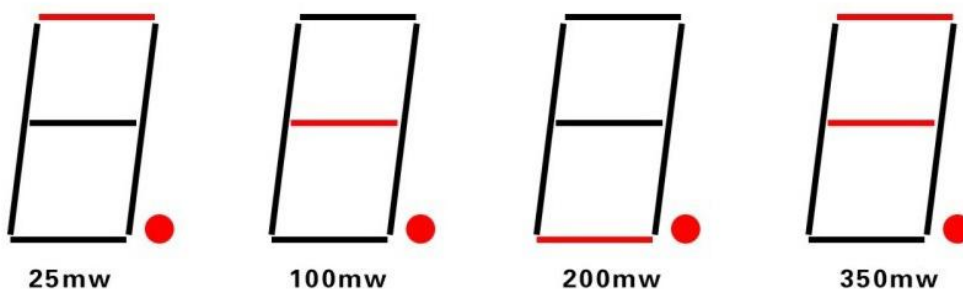

2.VTX serial port opens. The protocol is selected according to its own VTX protocol.

Identifier	Configuration/MSP	Serial Rx	Telemetry Output	Sensor Input	Peripherals
USB VCP	<input checked="" type="checkbox"/> 115200 ▾	<input type="checkbox"/>	Disabled ▾ AUTO ▾	Disabled ▾ AUTO ▾	Disabled ▾ AUTO ▾
UART1	<input type="checkbox"/> 115200 ▾	<input checked="" type="checkbox"/>	Disabled ▾ AUTO ▾	Disabled ▾ AUTO ▾	Disabled ▾ AUTO ▾
UART3	<input type="checkbox"/> 115200 ▾	<input type="checkbox"/>	Disabled ▾ AUTO ▾	Disabled ▾ AUTO ▾	IRC Tramp ▾ AUTO ▾
UART6	<input type="checkbox"/> 115200 ▾	<input type="checkbox"/>	Disabled ▾ AUTO ▾	Disabled ▾ AUTO ▾	Disabled ▾ AUTO ▾

3.Use OSD to adjust VTX

which displays information like battery voltage and mAh consumed while you fly. In addition, the Betaflight OSD can be used to configure the quadcopter, making in-field adjustments and tuning more convenient.

MODE2

MODE1

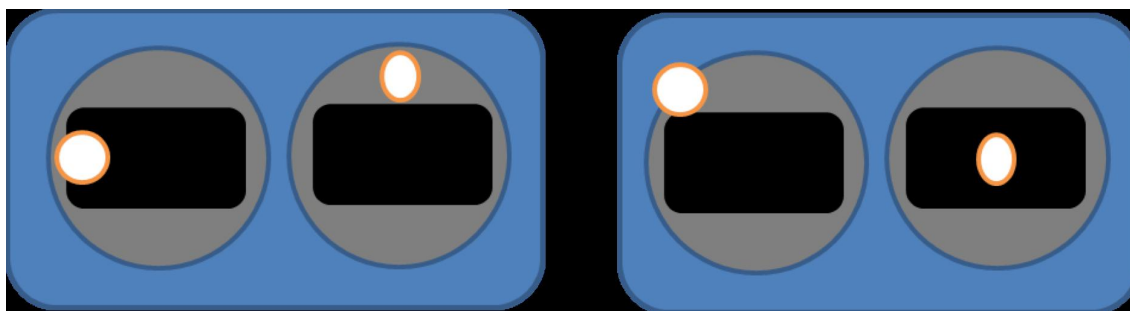

The graphics above show the stick command to bring up the OSD menu. The stick command is: throttle centered, yaw left, pitch forward. The exact stick command therefore depends on which mode your transmitter sticks are in.

In the OSD menu, use pitch up/down to move the cursor between menu items. When a menu option has a > symbol to the right of it, this indicates that it contains a sub-menu. Roll-right will enter the sub-menu. For example, in the screen to the right, moving the cursor to “Features” and then moving the roll stick to the right will enter the “Features” sub-menu.

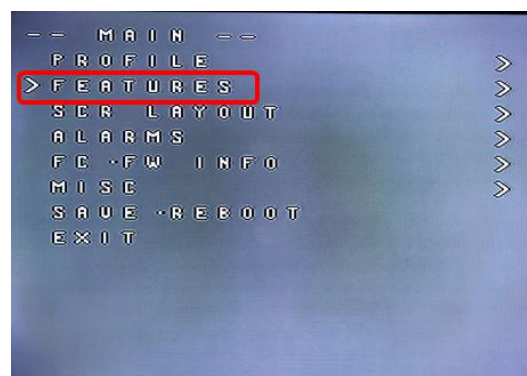



If you are using a video transmitter that supports remote configuration, enter the “Features” menu to configure the vTX. From there, enter either “VTX SA” if you are using SmartAudio (TBS Unify) or “VTX TR” if you are using IRC Tramp Telemetry.

To adjust PIDs, rates, and other tuning-related parameters, enter the “Profile” sub-menu.

In the “Scr Layout” sub-menu, you can move the OSD elements (like battery voltage, mAh, and so forth) around on the screen.

The “Alarms” sub-menu lets you control when the OSD will try to alert you that battery voltage is too low or mAh consumed is too high.

When a parameter can be modified, the parameter’s current value will be shown on the right-hand side of the screen. In this case, roll left/right will adjust the parameter up and down.

The screen to the right shows the current vTX settings. From here, you can change the frequency band, channel, and power level of the video transmitter. After making the changes, move the cursor to “Set” and press roll-right to confirm the settings.

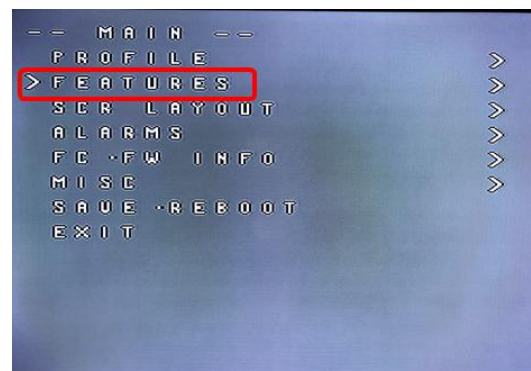
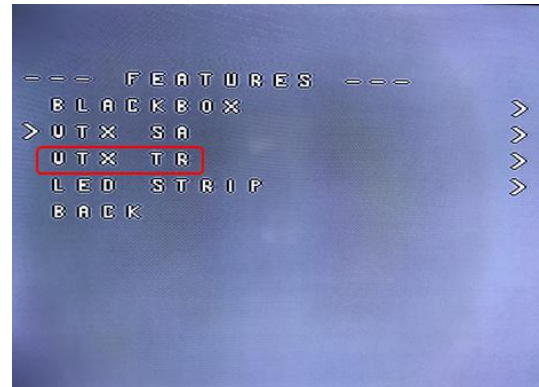

12.GPS parameters setting

1. GPS connection diagram

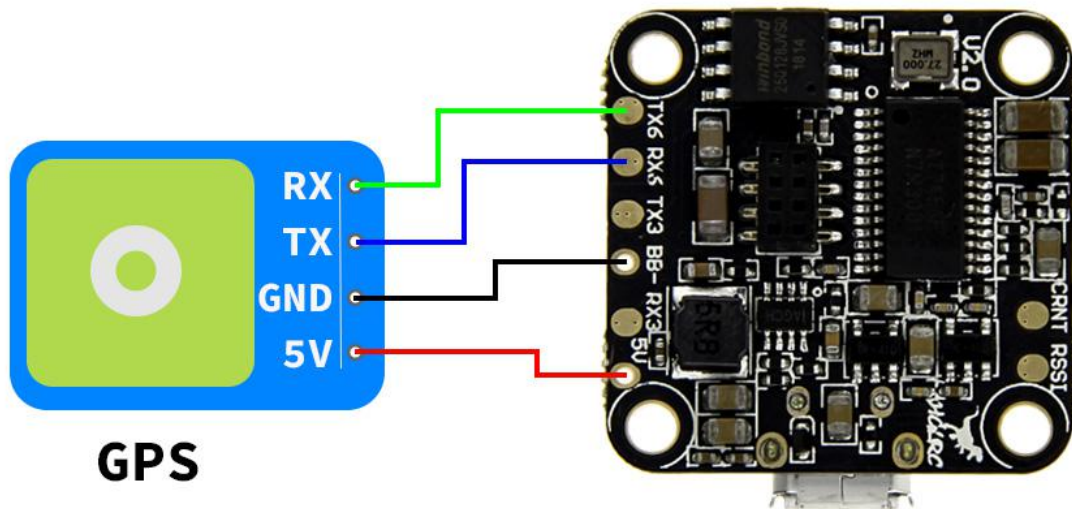

2. Open the GPS serial port

Identifier	Configuration/MSP	Serial Rx	Telemetry Output	Sensor Input	Peripherals
USB VCP	<input checked="" type="checkbox"/> 115200 ▾	<input type="checkbox"/>	Disabled ▾ AUTO ▾	Disabled ▾ AUTO ▾	Disabled ▾ AUTO ▾
UART1	<input type="checkbox"/> 115200 ▾	<input checked="" type="checkbox"/>	Disabled ▾ AUTO ▾	Disabled ▾ AUTO ▾	Disabled ▾ AUTO ▾
UART3	<input type="checkbox"/> 115200 ▾	<input type="checkbox"/>	Disabled ▾ AUTO ▾	Disabled ▾ AUTO ▾	Disabled ▾ AUTO ▾
UART6	<input type="checkbox"/> 115200 ▾	<input type="checkbox"/>	Disabled ▾ AUTO ▾	GPS ▾ 9600 ▾	Disabled ▾ AUTO ▾

3. When using the GPS function, remember to configure the serial port (via the Ports tab).

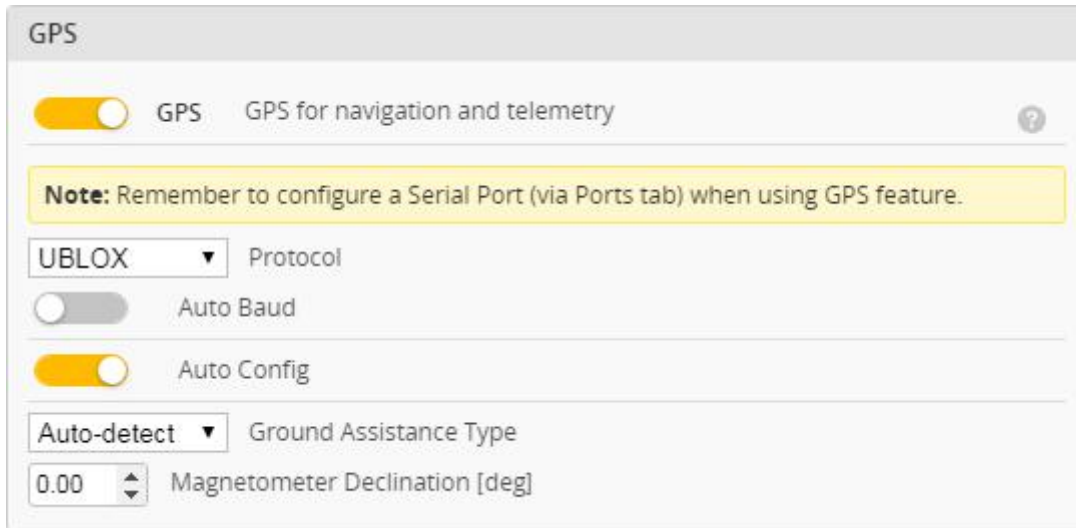

13. Check receiver signal

1. Click  Receiver. Check the remote control output signal

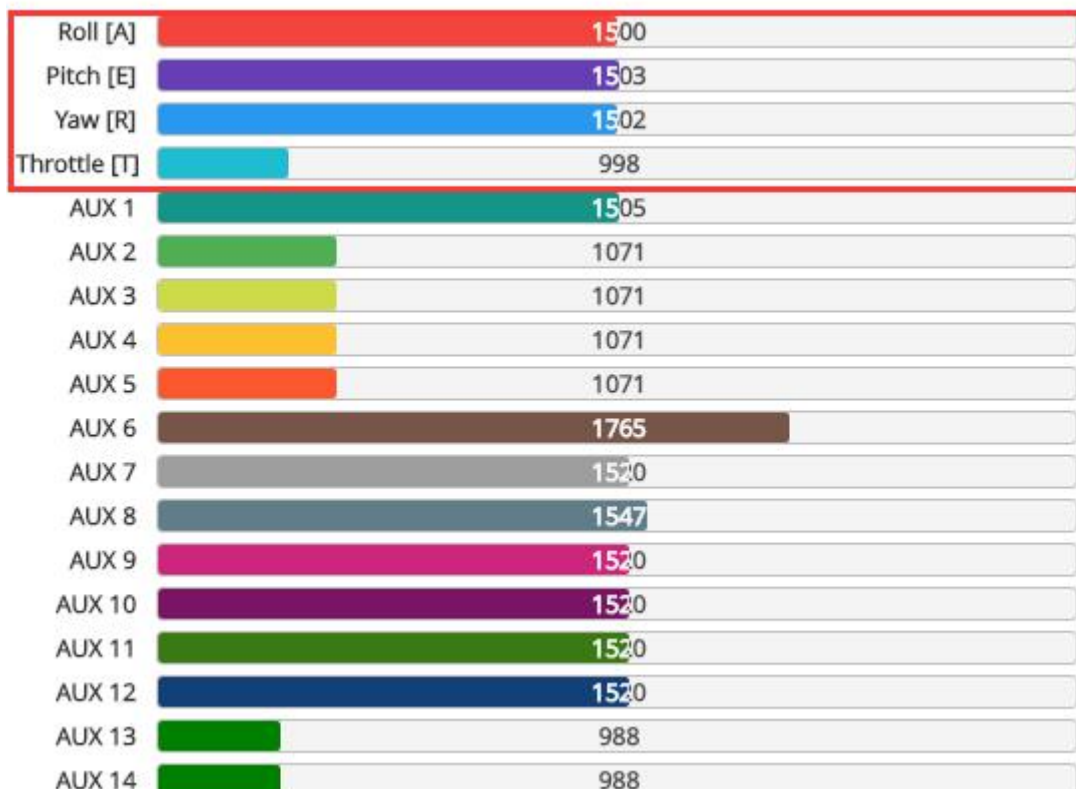

14. Select flight mode startup mode

1. Click  set up the function of remote control switch across the channel (below are for reference only)

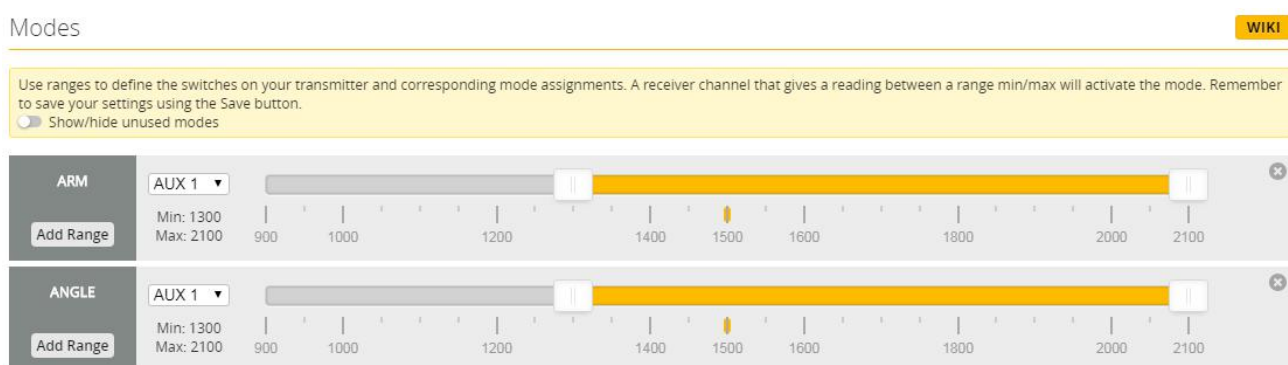

15. OSD settings

1. Click  the OSD Settings, according to the need to choose, drag the OSD schematic diagram of the parameters can be adjusted.



16. LED settings

1. Click **Configuration** Turn on LED support



2. Click **LED Strip**. Click **Wire Ordering Mode** set according to need



Clear selected Clear ALL **24** Remaining

LED Functions

Function **Color**

Color modifier Blink

Throttle [T] Blink always

Larson scanner

Overlay

Warnings

Indicator (uses position on matrix)

VTX (uses vtx frequency to assign color)

LED Orientation ('Modes & Orientation') and Color

N	U	0	1	2	3
W	E	4	5	6	7
S	D	8	9	10	11
		12	13	14	15

LED Strip Wiring

Wire Ordering Mode

Clear selected Clear ALL Wiring

17.Troubleshooting

Warning:

Please read the cautions as follows, otherwise stability of your flight controller cannot be ensured, your flight controller will even get damaged.

- Keep focus on the polarity. Check carefully before power supply.
- Cut off the power when you connect, plug and pull anything.
- The refresh rate of PID and Gyroscope is up to 32K/16K.

after sales question:

1. After receiving the goods, it is found that the product can not be used normally. If the return to the factory is a quality problem, the repair service will be provided free of charge.
2. If the product is damaged due to improper operation, the repair service may be provided under the condition that the inspection can be repaired.
3. For domestic customers, please contact the after-sales service personnel. For overseas customers, please contact the official website for after-sales service.

Product daily problems

1.OSD garbled:

If you find garbled characters, please open Betaflight, click “OSD” .and click “Font Manager” clicks on “Upload Font” to update

1. When plugged in the battery, the aircraft does not pass the self-test without "BBB" sound. There is only one sound.

Please check if the ESC agreement is correct

3.The spin of the aircraft keeps spinning

1. Please check if the propeller is correct
2. Please check if the motor direction is correct