



---

# HGLRC Forward F722

## mini Flight Control

# Manual

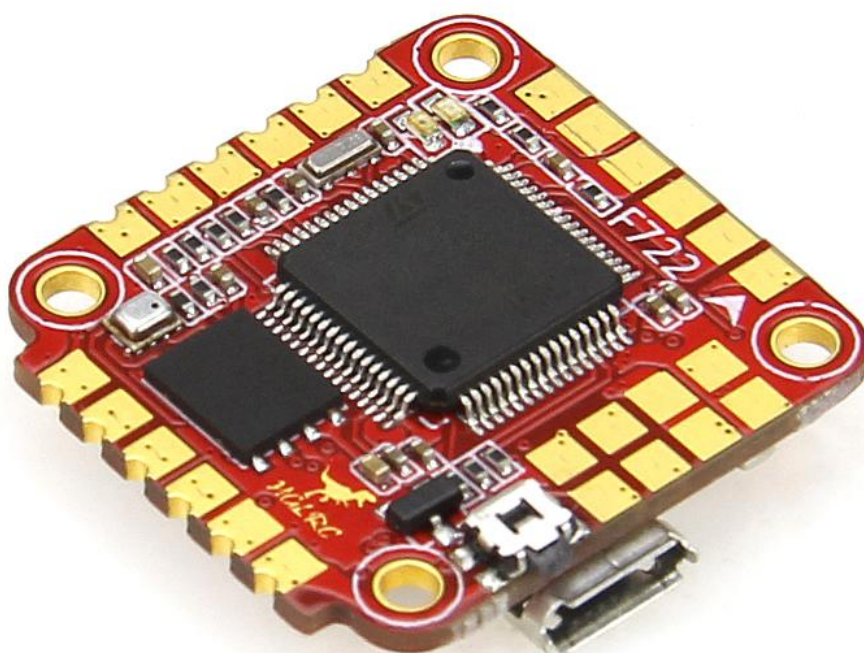

# Contents

<b>Product Specifications.....</b>	<b>1</b>
<b>Interface Description.....</b>	<b>2</b>
<b>Check the flight control drive.....</b>	<b>3</b>
<b>Calibration accelerometer.....</b>	<b>4</b>
<b>URAT serial port use.....</b>	<b>5</b>
<b>Select aircraft model.....</b>	<b>6</b>
<b>Choose ESC protocol.....</b>	<b>7</b>
<b>Select ESC telemetry.....</b>	<b>8</b>
<b>Voltage and current parameters setting.....</b>	<b>9</b>
<b>Setting up the receiver.....</b>	<b>10</b>
<b>VTX serial port use. VTX uses OSD smart audio.....</b>	<b>11</b>
<b>GPS parameters setting.....</b>	<b>12</b>
<b>Check receiver signal.....</b>	<b>13</b>
<b>Select flight mode startup mode.....</b>	<b>14</b>
<b>OSD settings.....</b>	<b>15</b>
<b>LED settings.....</b>	<b>16</b>
<b>Troubleshooting.....</b>	<b>17</b>

.....

## Package Included

Forward F722 mini Flight Control*1	SH1.0 8PIN 60MM*1

# 1. Product Specifications

Product parameters	
Model	Forward F722 mini Flight Control
Weight	3.7g
Usage	for 100mm-450mm Frame Kit
MPU	MPU6000
CPU	STM32F722 RET6
Black Box	16M
Support receiver	SBUS .IBUS.DSMX/R9MM
Input Voltage	2-6S Lipo
BEC Output	5V/3A
Size	23.7x26.6mm board, 20mm mounting holes

# 2. Interface Description

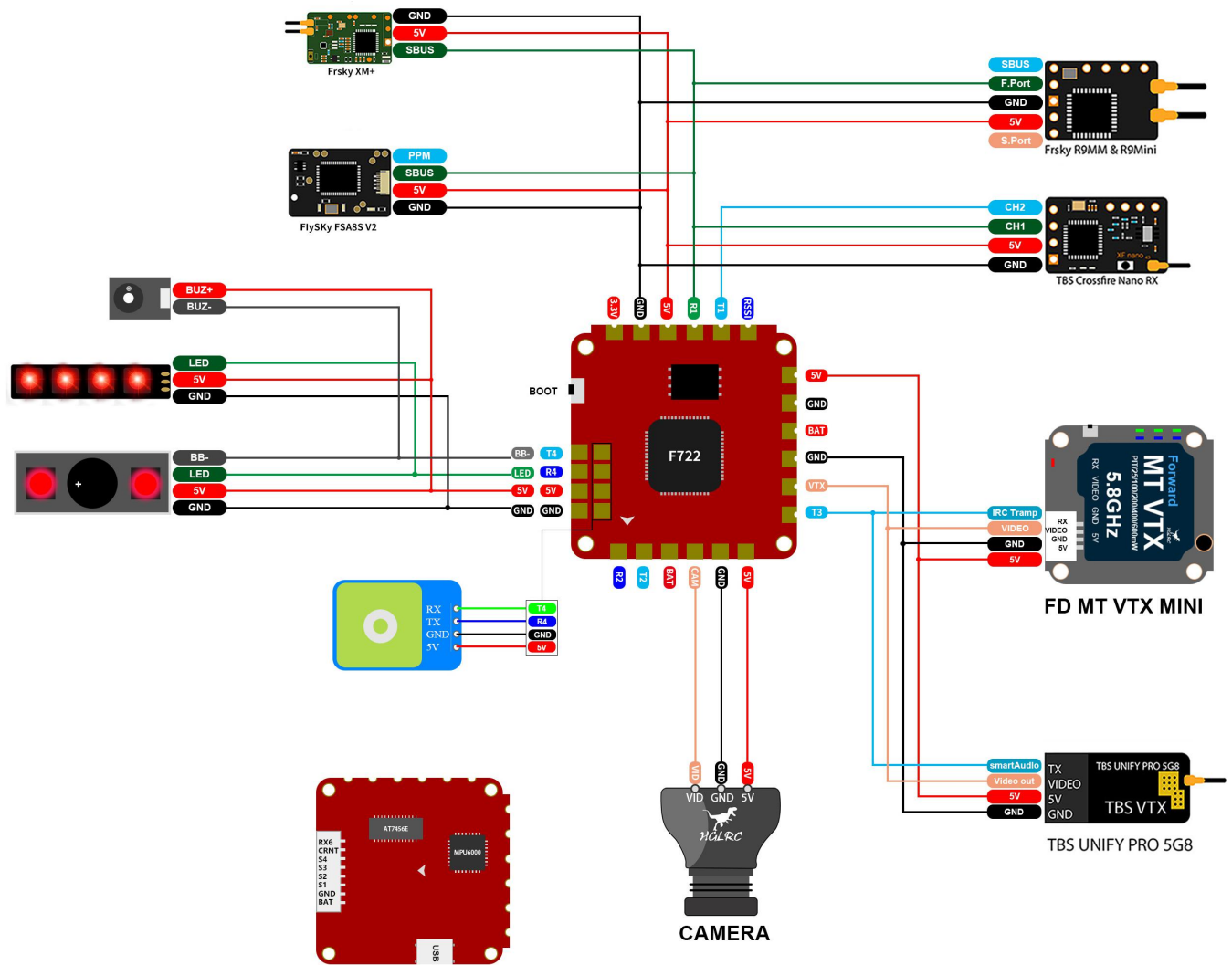

## 3. Check the flight control drive

1. Long Press BOOT buttons.connect USB.The system automatically install the driver



2.Driver cannot be installed, please download ImpulseRC\_Driver\_Fixer



3.Double-click on the run(Plug in the flight controller to automatically install the driver)

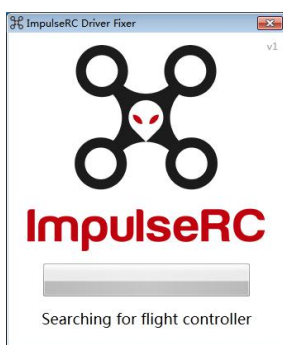

4.open betafight configurator , enter DFU mode

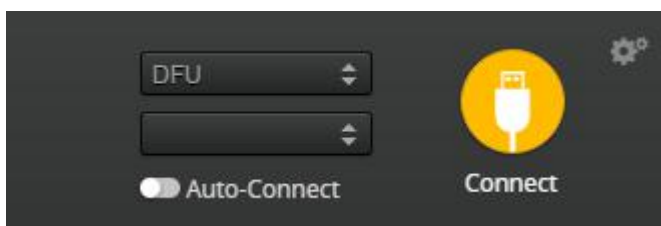

5. Click **Firmware Flasher** Select firmware version

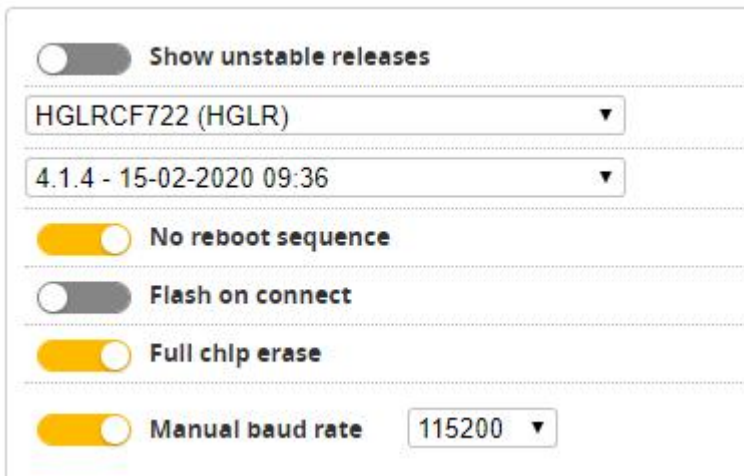

6. Click **Load Firmware [Online]** Load firmware. **Flash Firmware** Waiting for completion **Erasing ...** It will be prompted upon completion. **Programming: SUCCESSFUL**

7. open betaflyght configurator . Controller plugged into the computer. Betaflight Automatically assigned port, click "Connect" Enter setup interface (Different computer COM)



## 4. Calibration accelerometer

1. Put the aircraft horizontal and click “Reset Z axis”

Click again 

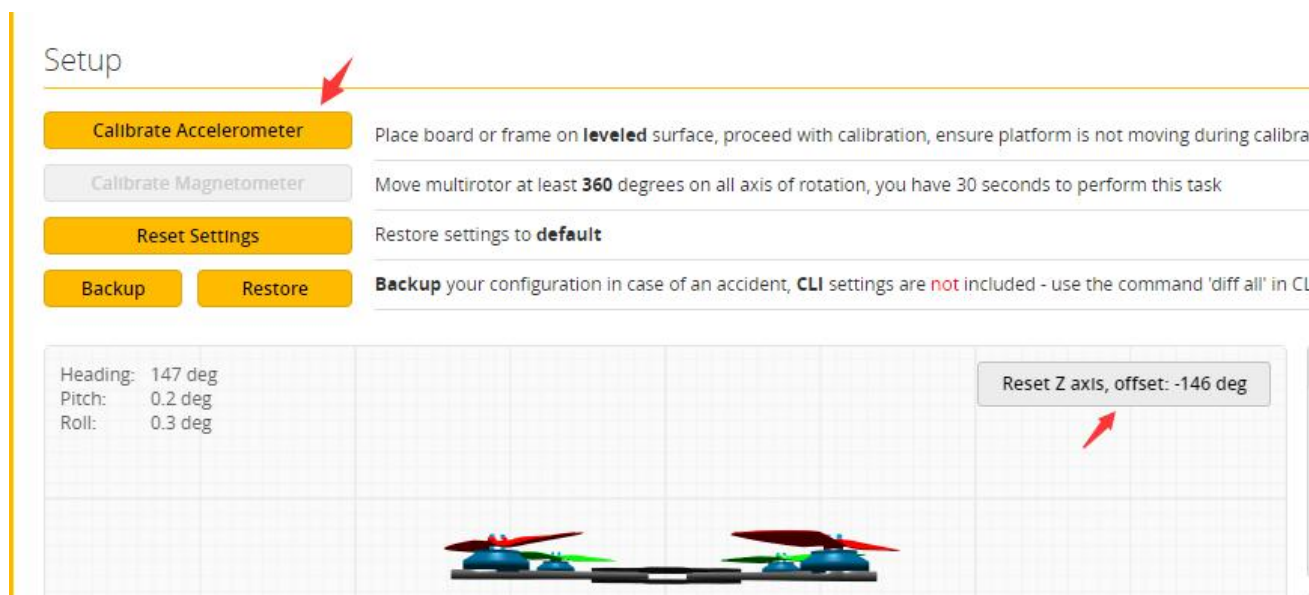

## 5.URAT serial port use

1.URAT1 uses the receiver

2.URAT2

3.URAT3 uses VTX image transmission

4.URAT4 uses GPS

5.URAT6 uses ESC telemetry

# 6. Select aircraft model

1. Click  Configuration Select model

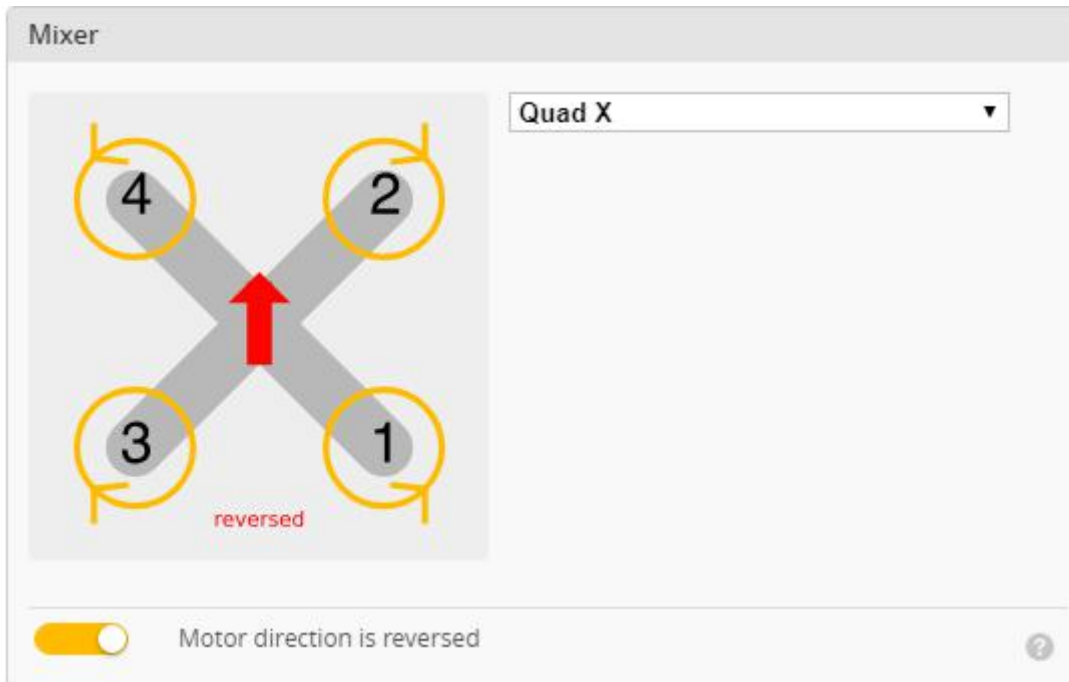

2. Click  Motors Click “**I understand the risks**” Push Master to check motor steering “**Master**” Steering can be changed at [BLHeliSuite](#)

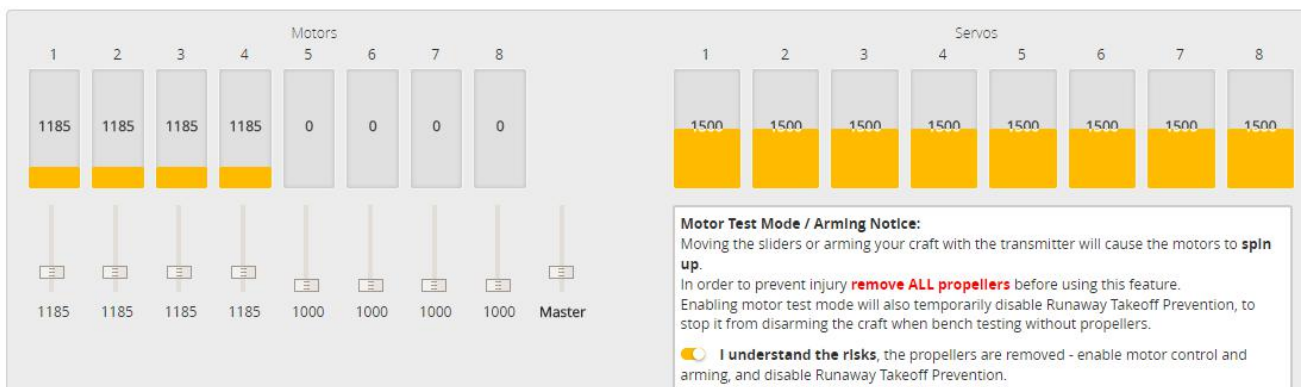



# 7. Choose ESC protocol

1. Choose the right ESC protocol, the optional universal protocol DSHOT600.

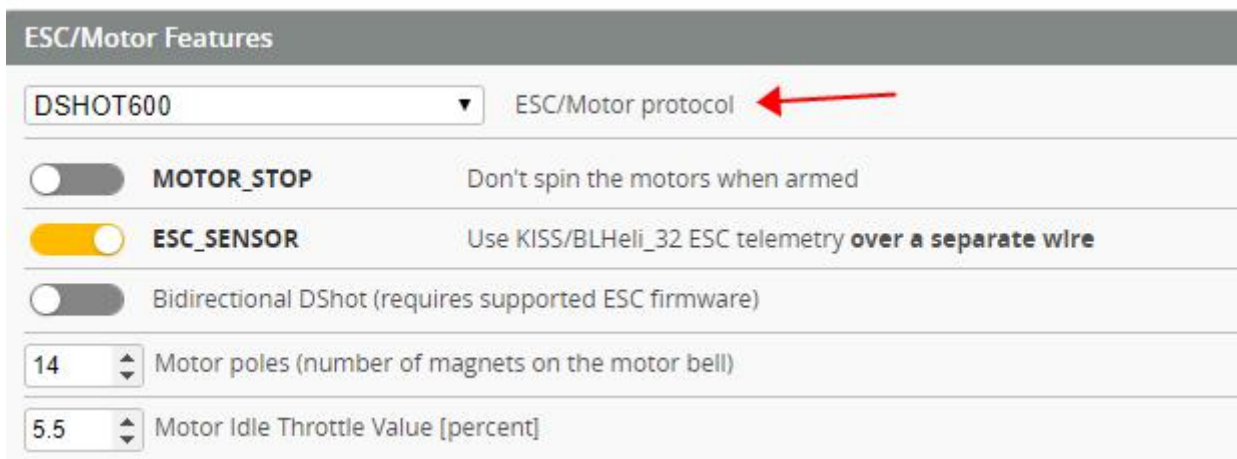

# 8. Turn on ESC telemetry

1. Use BLHeli\_32 ESC telemetry over a separate wire

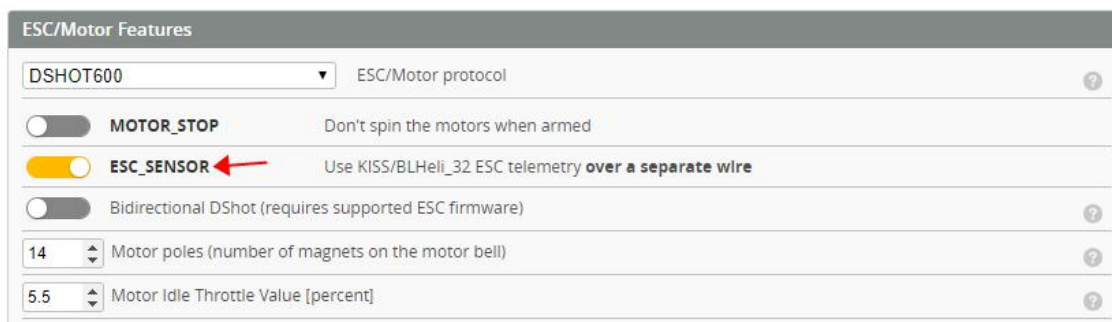

2. Open ESC telemetry serial port. TX on the ESC needs to be connected to the RX6 on the flight controller to use the ESC telemetry

Ports

WIKI

**Note:** not all combinations are valid. When the flight controller firmware detects this the serial port configuration will be reset.  
**Note:** Do **NOT** disable MSP on the first serial port unless you know what you are doing. You may have to refresh and erase your configuration if you do.

Identifier	Configuration/MSP	Serial Rx	Telemetry Output	Sensor Input	Peripherals
USB VCP	<input checked="" type="checkbox"/> 115200	<input type="checkbox"/>	Disabled   AUTO	Disabled   AUTO	Disabled   AUTO
UART1	<input type="checkbox"/> 115200	<input checked="" type="checkbox"/>	Disabled   AUTO	Disabled   AUTO	Disabled   AUTO
UART2	<input type="checkbox"/> 115200	<input type="checkbox"/>	Disabled   AUTO	Disabled   AUTO	Disabled   AUTO
UART3	<input type="checkbox"/> 115200	<input type="checkbox"/>	Disabled   AUTO	Disabled   AUTO	VTX (IRC Tran)   AUTO
UART4	<input type="checkbox"/> 115200	<input type="checkbox"/>	Disabled   AUTO	GPS   115200	Disabled   AUTO
UART6	<input type="checkbox"/> 115200	<input type="checkbox"/>	Disabled   AUTO	ESC   AUTO	Disabled   AUTO

### 3.View telemetry data on OSD

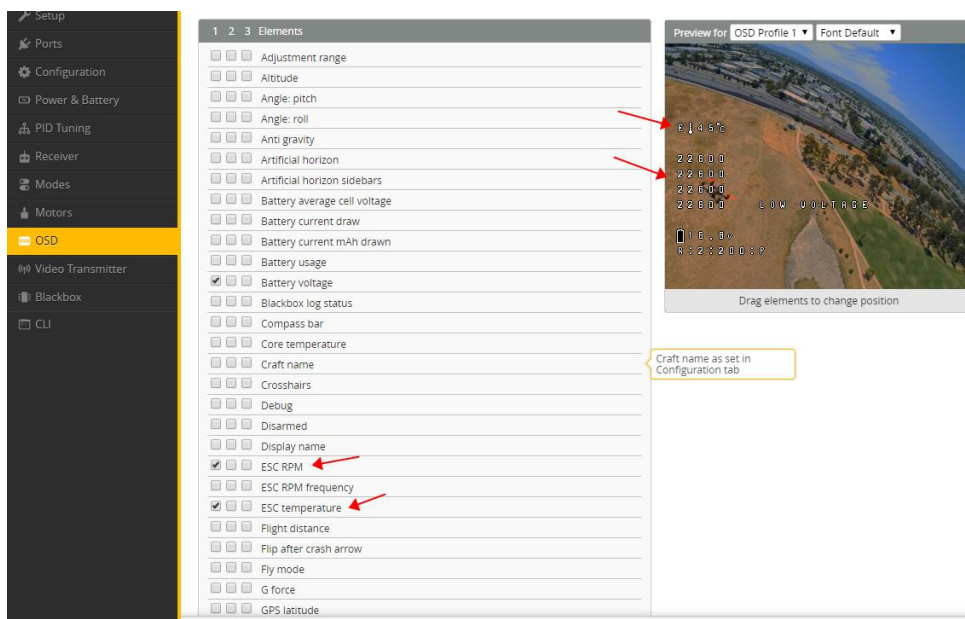

# 9.Voltage and current parameters setting

1.Click **Power & Battery** Setting parameters

**Battery**

Onboard ADC Voltage Meter Source

Onboard ADC Current Meter Source

3.3 Minimum Cell Voltage

4.3 Maximum Cell Voltage

3.5 Warning Cell Voltage

0 Capacity (mAh)

---

**Voltage Meter**

Battery 0 V

110 Scale

10 Divider Value

1 Multiplier Value

---

**Amperage Meter**

Battery 0.00 A

179 Scale [1/10th mV/A]

0 Offset [mA]

# 10. Setting up the receiver

## 1. Receiver connection diagram

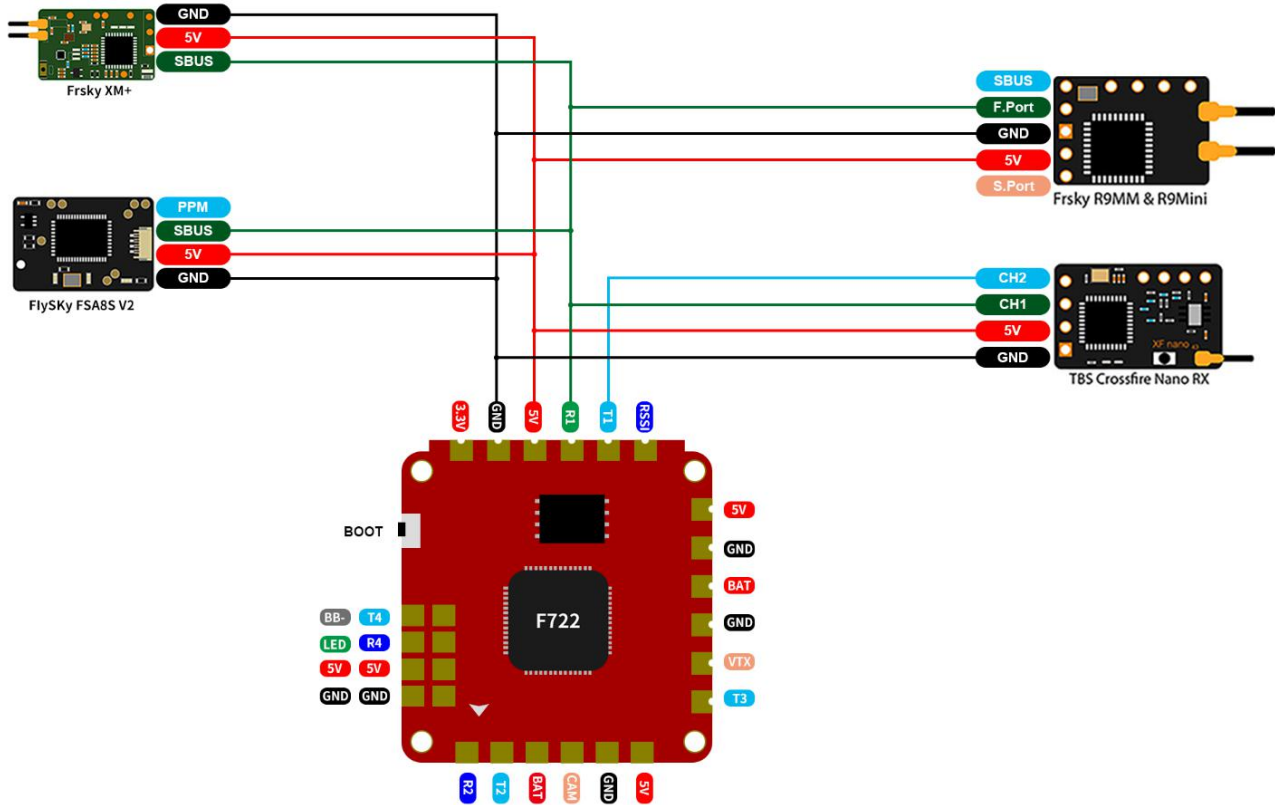

## 2. Click have found "UART1" Open the receiver serial port

Ports WIKI

Note: not all combinations are valid. When the flight controller firmware detects this the serial port configuration will be reset.  
Note: Do NOT disable MSP on the first serial port unless you know what you are doing. You may have to reflash and erase your configuration if you do.

Identifier	Configuration/MSP	Serial Rx	Telemetry Output	Sensor Input	Peripherals
USB VCP	<input checked="" type="checkbox"/> 115200	<input type="checkbox"/>	Disabled   AUTO	Disabled   AUTO	Disabled   AUTO
UART1	<input type="checkbox"/> 115200	<input checked="" type="checkbox"/>	Disabled   AUTO	Disabled   AUTO	Disabled   AUTO
UART2	<input type="checkbox"/> 115200	<input type="checkbox"/>	Disabled   AUTO	Disabled   AUTO	Disabled   AUTO
UART3	<input type="checkbox"/> 115200	<input type="checkbox"/>	Disabled   AUTO	Disabled   AUTO	VTX (IRC Tran   AUTO
UART4	<input type="checkbox"/> 115200	<input type="checkbox"/>	Disabled   AUTO	GPS   115200	Disabled   AUTO
UART6	<input type="checkbox"/> 115200	<input type="checkbox"/>	Disabled   AUTO	ESC   AUTO	Disabled   AUTO

## 3. Set the SBUS receiver

**Receiver**

Serial-based receiver (SPEKSAT, S) Receiver Mode

**Note:** Remember to configure a Serial Port (via Ports tab) and choose a Serial Receiver Provider when using RX\_SERIAL feature.

SBUS Serial Receiver Provider

#### 4. Set the PPM receiver

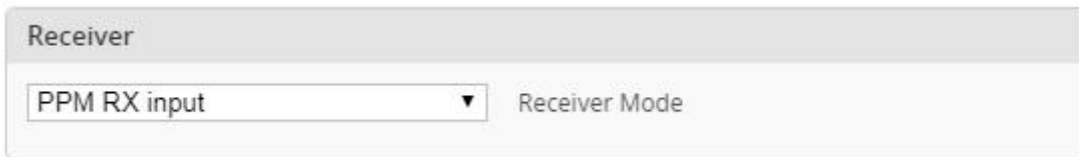

#### 5. Set the DSMX receiver

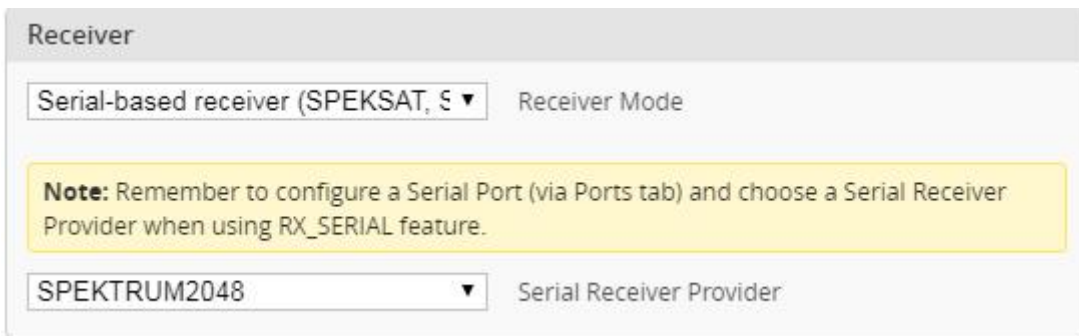

# 11. VTX serial port use. VTX uses OSD smart audio

## 1. VTX connection diagram

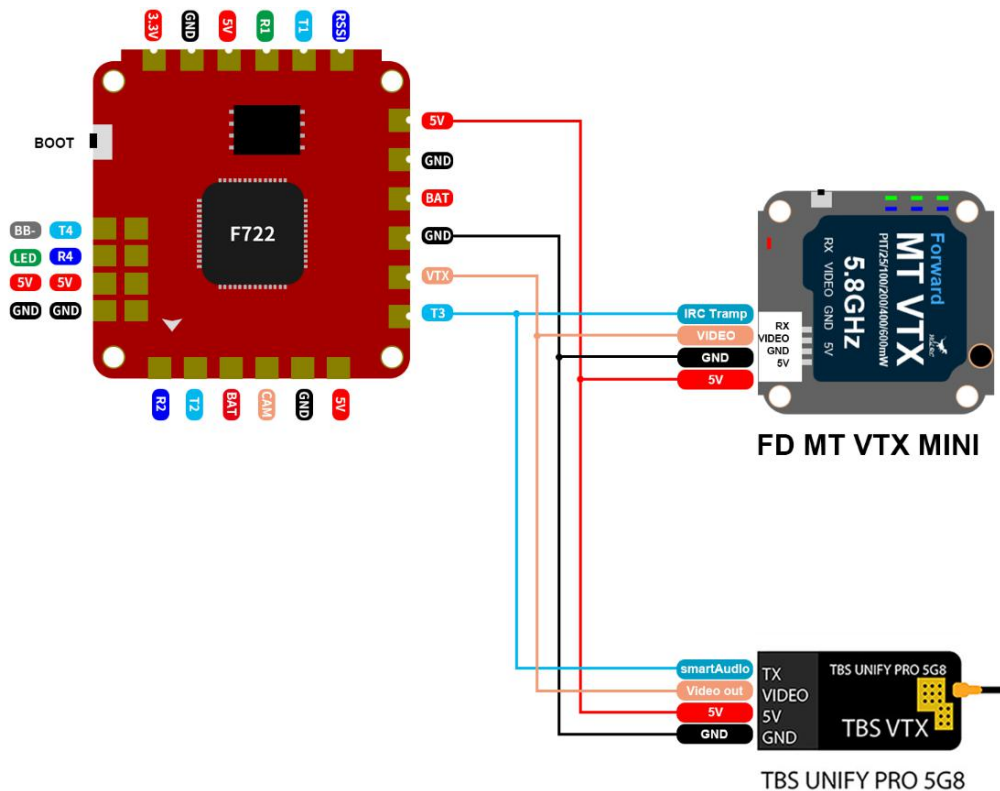

## 2.VTX serial port opens. The protocol is selected according to its own VTX protocol.

Ports

WIKI

Note: not all combinations are valid. When the flight controller firmware detects this the serial port configuration will be reset.

Note: Do NOT disable MSP on the first serial port unless you know what you are doing. You may have to refresh and erase your configuration if you do.

Identifier	Configuration/MSP	Serial Rx	Telemetry Output	Sensor Input	Peripherals
USB VCP	<input checked="" type="checkbox"/> 115200	<input type="checkbox"/>	Disabled   AUTO	Disabled   AUTO	Disabled   AUTO
UART1	<input checked="" type="checkbox"/> 115200	<input checked="" type="checkbox"/>	Disabled   AUTO	Disabled   AUTO	Disabled   AUTO
UART2	<input type="checkbox"/> 115200	<input type="checkbox"/>	Disabled   AUTO	Disabled   AUTO	Disabled   AUTO
UART3	<input type="checkbox"/> 115200	<input type="checkbox"/>	Disabled   AUTO	Disabled   AUTO	VTX (IRC Tran   AUTO
UART4	<input type="checkbox"/> 115200	<input type="checkbox"/>	Disabled   AUTO	GPS   115200	Disabled
UART6	<input type="checkbox"/> 115200	<input type="checkbox"/>	Disabled   AUTO	ESC   AUTO	Blackbox logging

## 3.Use OSD to adjust VTX

which displays information like battery voltage and mAh consumed while you fly. In addition, the Betaflight OSD can be used to configure the quadcopter, making in-field adjustments and tuning more convenient.

MODE2

MODE1

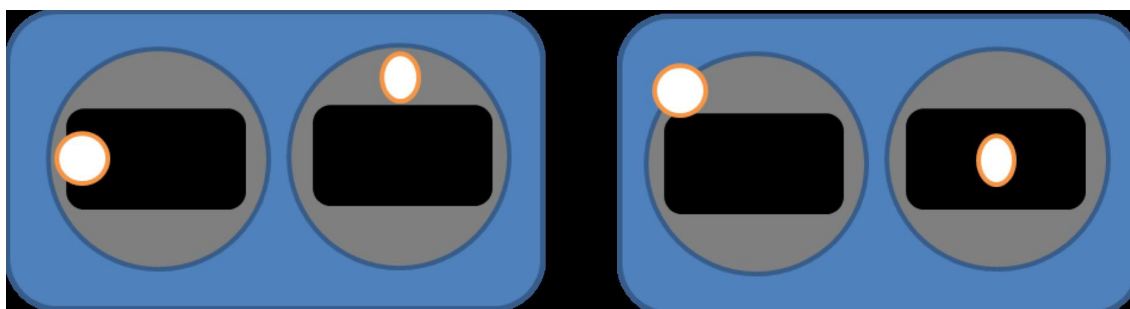

The graphics above show the stick command to bring up the OSD menu. The stick command is: throttle centered, yaw left, pitch forward. The exact stick command therefore depends on which mode your transmitter sticks are in.

In the OSD menu, use pitch up/down to move the cursor between menu items. When a menu option has a > symbol to the right of it, this indicates that it contains a sub-menu. Roll-right will enter the sub-menu. For example, in the screen to the right, moving the cursor to “Features” and then moving the roll stick to the right will enter the “Features” sub-menu.

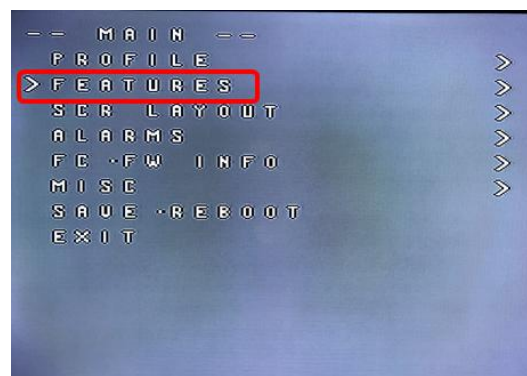

If you are using a video transmitter that supports remote configuration, enter the “Features” menu to configure the



vTX. From there, enter either “VTX SA” if you are using SmartAudio (TBS Unify) or “VTX TR” if you are using IRC Tramp Telemetry.

To adjust PIDs, rates, and other tuning-related parameters, enter the “Profile” sub-menu.

In the “Scr Layout” sub-menu, you can move the OSD elements (like battery voltage, mAh, and so forth) around on the screen.

The “Alarms” sub-menu lets you control when the OSD will try to alert you that battery voltage is too low or mAh consumed is too high.

When a parameter can be modified, the parameter’s current value will be shown on the right-hand side of the screen. In this case, roll left/right will adjust the parameter up and down.

The screen to the right shows the current vTX settings. From here, you can change the frequency band, channel, and power level of the video transmitter. After making the changes, move the cursor to “Set” and press roll-right to confirm the settings.

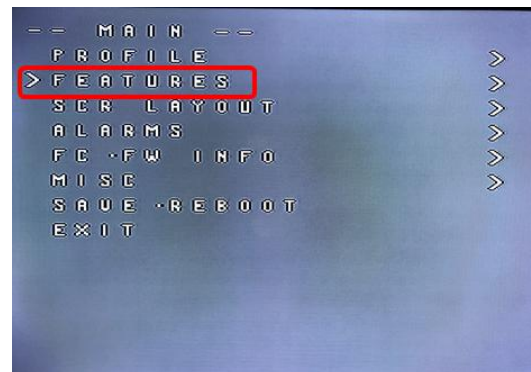
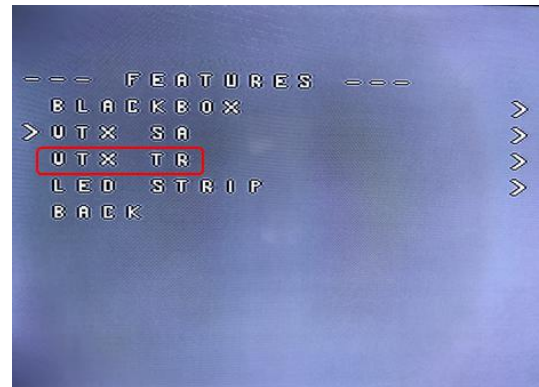



# 12.GPS parameters setting

## 1. GPS connection diagram

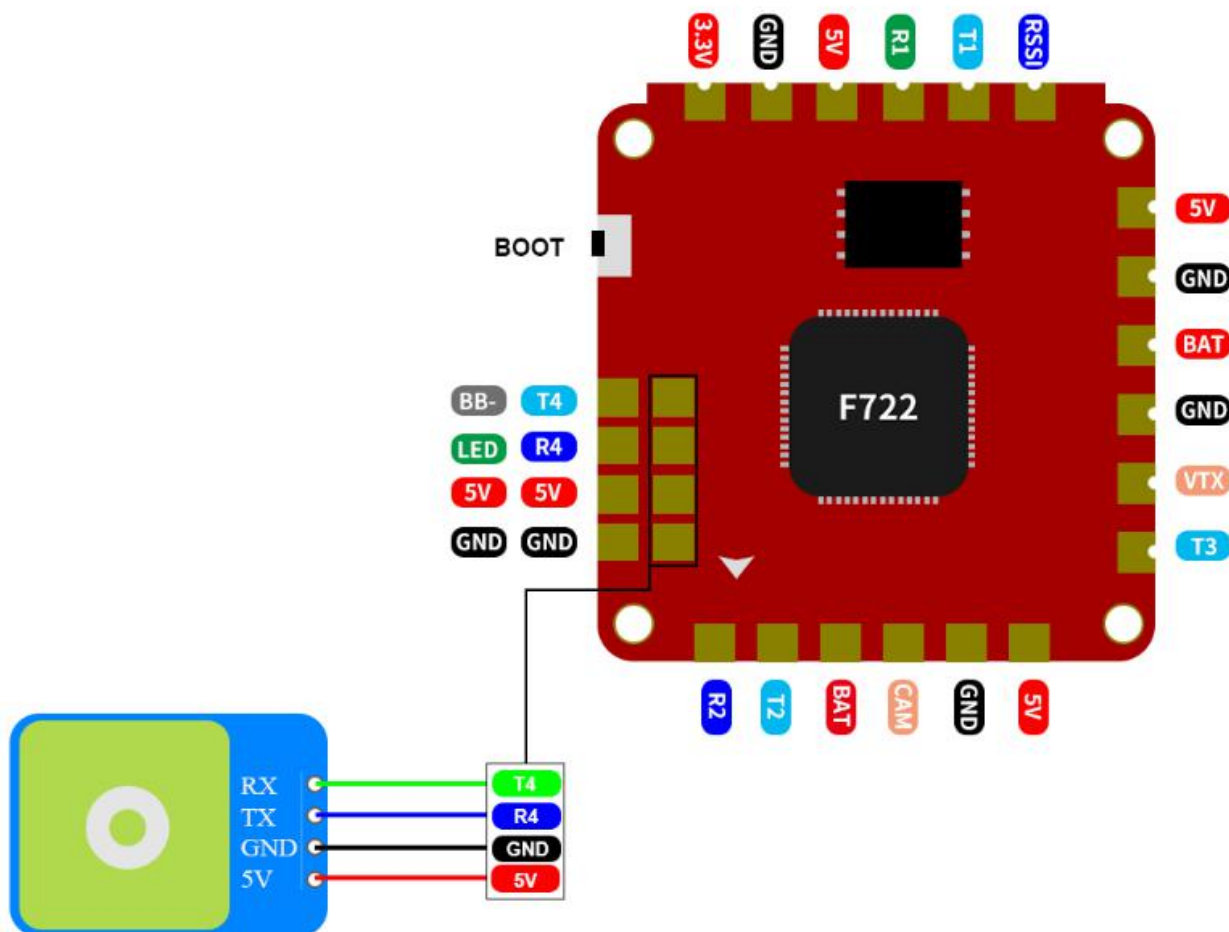

## 2.Open the GPS serial port

Ports

WIKI

**Note:** not all combinations are valid. When the flight controller firmware detects this the serial port configuration will be reset.  
**Note:** Do **NOT** disable MSP on the first serial port unless you know what you are doing. You may have to reflash and erase your configuration if you do.

Identifier	Configuration/MSP	Serial Rx	Telemetry Output	Sensor Input	Peripherals
USB VCP	<input checked="" type="checkbox"/> 115200	<input type="checkbox"/>	Disabled   AUTO	Disabled   AUTO	Disabled   AUTO
UART1	<input type="checkbox"/> 115200	<input checked="" type="checkbox"/>	Disabled   AUTO	Disabled   AUTO	Disabled   AUTO
UART2	<input type="checkbox"/> 115200	<input type="checkbox"/>	Disabled   AUTO	Disabled   AUTO	Disabled   AUTO
UART3	<input type="checkbox"/> 115200	<input type="checkbox"/>	Disabled   AUTO	Disabled   AUTO	VTX (IRC Tran   AUTO
UART4	<input type="checkbox"/> 115200	<input type="checkbox"/>	Disabled   AUTO	GPS   115200	Disabled   AUTO
UART6	<input type="checkbox"/> 115200	<input type="checkbox"/>	Disabled   AUTO	ESC   AUTO	Disabled   AUTO

3. When using the GPS function, remember to configure the serial port (via the Ports tab).

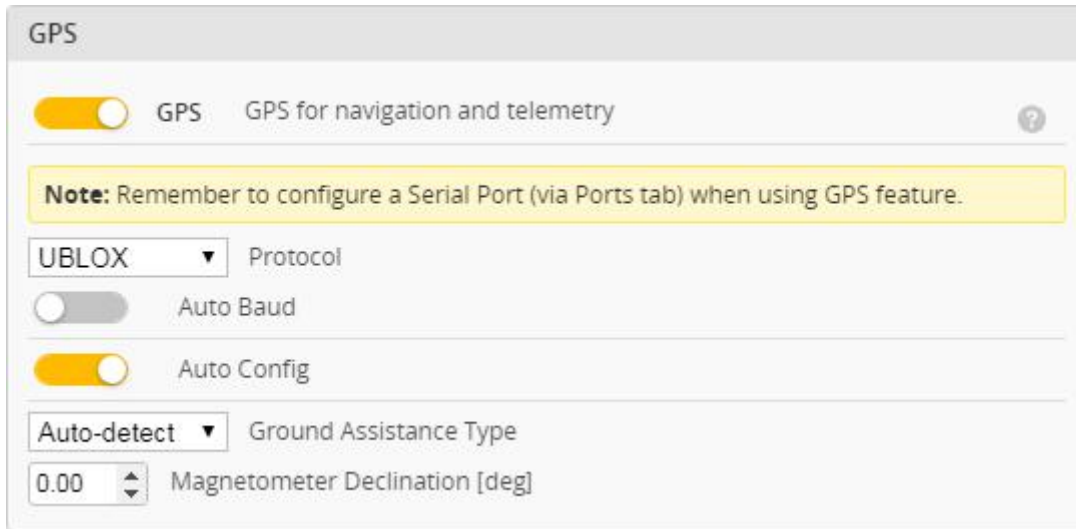

## 13. Check receiver signal

1. Click  Receiver Check the remote control output signal

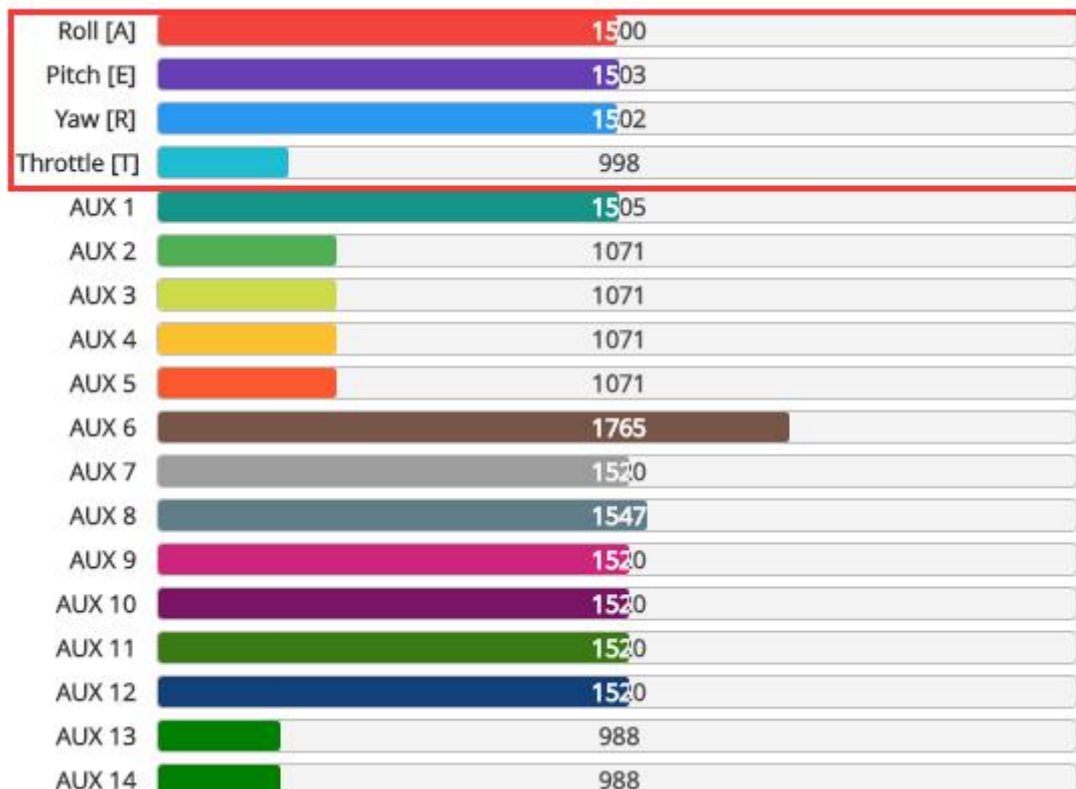



# 14. Select flight mode startup mode

1. Click **Modes** set up the function of remote control switch across the channel (below are for reference only)

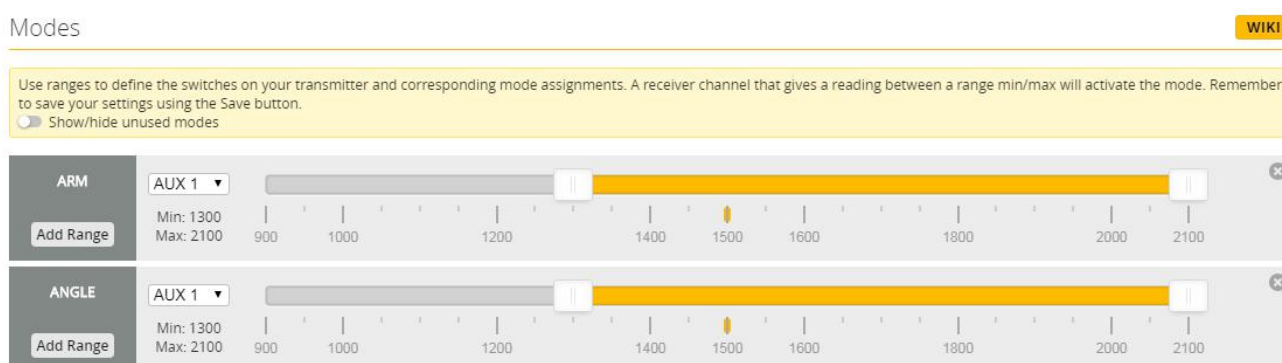

# 15. OSD settings

1. Click **OSD** the OSD Settings, according to the need to choose, drag the OSD schematic diagram of the parameters can be adjusted.

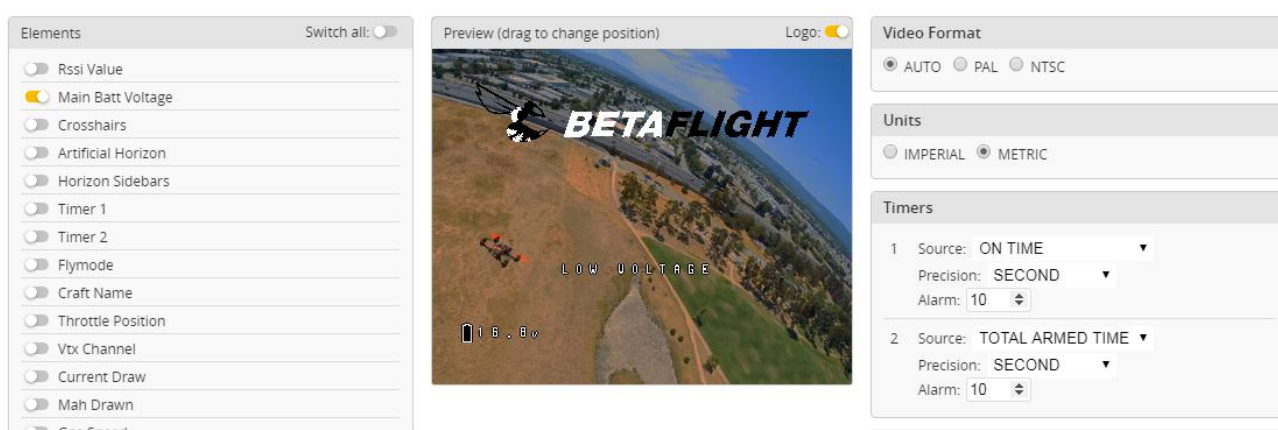

# 16. LED settings

1.LED function buttons:

Short press to switch colors.

Press and hold for 3 seconds to enter the blinking mode switch

(LED status light is always on)

2.Blinking mode:

Steady / Fast Flash / Breathing Light / Colorful Slow Flash

3.Click  Configuration Turn on LED support



4.Click  LED Strip .Click  set according to need



The image shows a screenshot of an LED matrix configuration interface. On the left is a 10x10 grid of LEDs. A row of 8 LEDs in the 6th row is highlighted with red boxes and numbered 0 through 7. On the right, there are several control panels:

- Clear selected** and **Clear ALL** buttons.
- 24 Remaining** indicator.
- LED Functions** section:
  - Function: **Color** (dropdown menu)
  - Color modifier: **Blink** (dropdown menu)
  - Throttle [T]
  - Larson scanner
  - Blink always
- Overlay** section:
  - Warnings
  - Indicator (uses position on matrix)
  - VTX (uses vtx frequency to assign color)
- LED Orientation ('Modes & Orientation') and Color** section:
  - Orientation buttons: N, U, W, E, S, D.
  - Color selection grid with 16 numbered buttons (0-15) in various colors (red, orange, yellow, green, cyan, blue, purple, magenta).
- LED Strip Wiring** section:
  - Wire Ordering Mode** button (highlighted in green).
  - Clear selected** and **Clear ALL Wiring** buttons.

# 17.Troubleshooting

## Warning:

Please read the cautions as follows, otherwise stability of your flight controller cannot be ensured, your flight controller will even get damaged.

- Keep focus on the polarity. Check carefully before power supply.
- Cut off the power when you connect, plug and pull anything.
- The refresh rate of PID and Gyroscope is up to 32K/16K.

## after sales question:

1. After receiving the goods, it is found that the product can not be used normally. If the return to the factory is a quality problem, the repair service will be provided free of charge.
2. If the product is damaged due to improper operation, the repair service may be provided under the condition that the inspection can be repaired.
3. For domestic customers, please contact the after-sales service personnel.  
For overseas customers, please contact the official website for after-sales service.

## Product daily problems

### 1.OSD garbled:

If you find garbled characters, please open Betaflight, click “OSD” .and click “Font Manager” clicks on “Upload Font” to update

1. When plugged in the battery, the aircraft does not pass the self-test without "BBB" sound. There is only one sound.

Please check if the ESC agreement is correct

### 3.The spin of the aircraft keeps spinning

1. Please check if the propeller is correct
2. Please check if the motor direction is correct