

Lotus Beto M
H470
H470+
H470W
H470W+

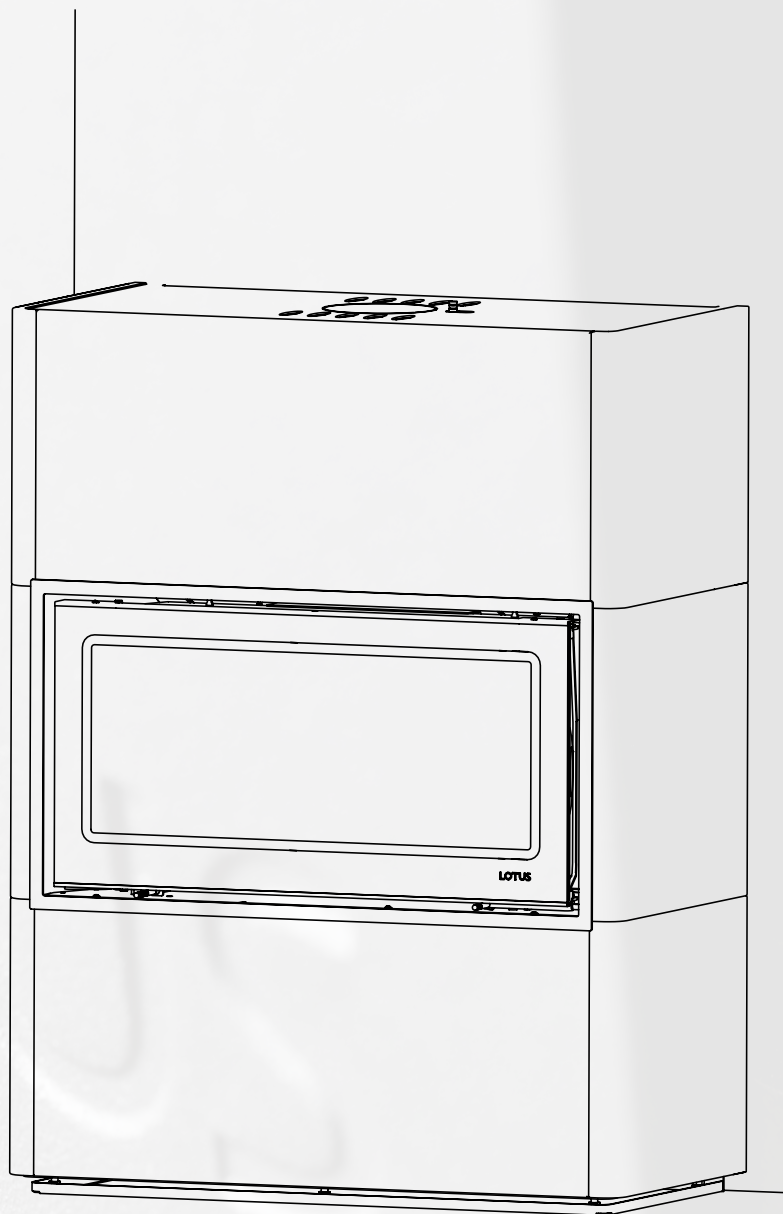

1

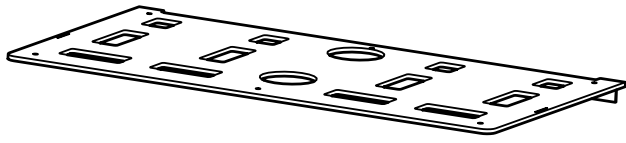

1x 47023 470
1x 48027 470W

2

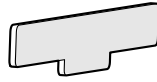

2x 44-228

3

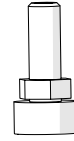

6x B-500004

4



6x B-210010

5

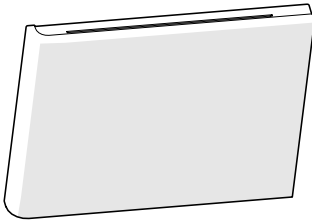

4x 47011
4x 78009 Beto +

6



4x 48-0049
4x 48-0050 Beto +

7



30x B-020006

8

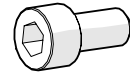

28x B-320612

9

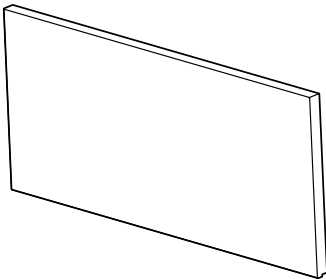

2x 47012 470
2x 47015 470+
1x 48021 470W
1x 48022 470W+

10

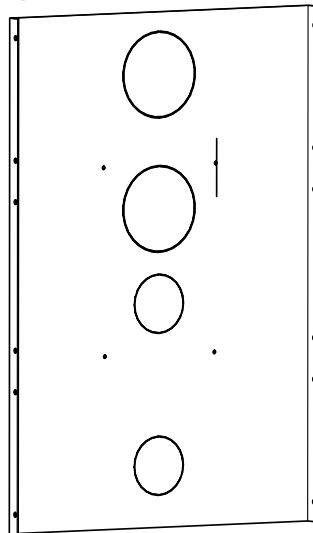

1x Beto 494 470
1x Beto 494+ 470+
1x 48034 470W
1x 48046 470W+

11

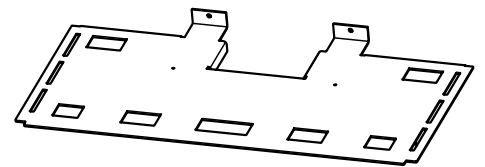

1x 47-0034 470
1x 48028 470W

12

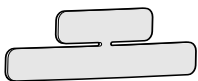

4x 44-218

13



4x 78-0055

14



4x B- 210008

15

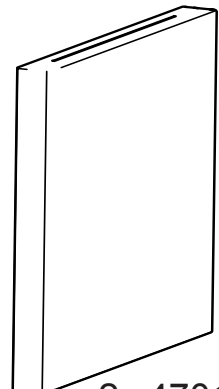

2x 47013

16



3x 78-0048

17

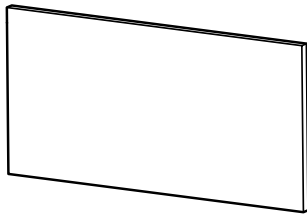

1x Beto 491 470
1x Beto 491W 470W

18

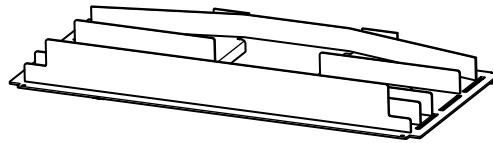

1x 47024 470
1x 48029 470W

19

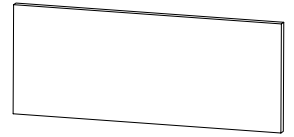

1x Beto 491 470
1x Beto 491W 470W

20



2x B-330806

21



2x B-360616

22



6x 78-0028 470
8x 78-0028 470W

23



14x 78-0027 470
16x 78-0027 470W

24

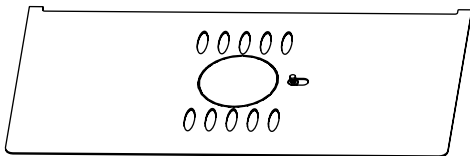

1x 47016 470
1x 48023 470W

25



8x B-360506

26

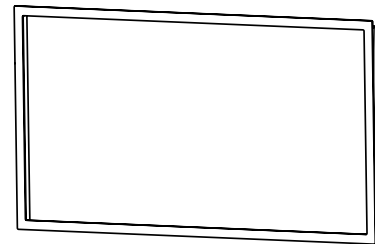

1x 47007 470
1x 47017 470 Magic
1x 48017 470W
1x 48026 470W Magic

27

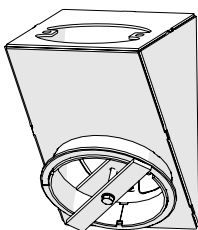

Beto 115

28



47-0036 470
48-0047 470W

29

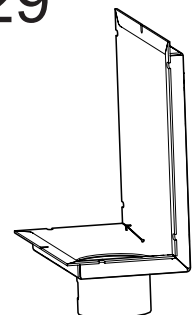

Option H307

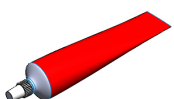

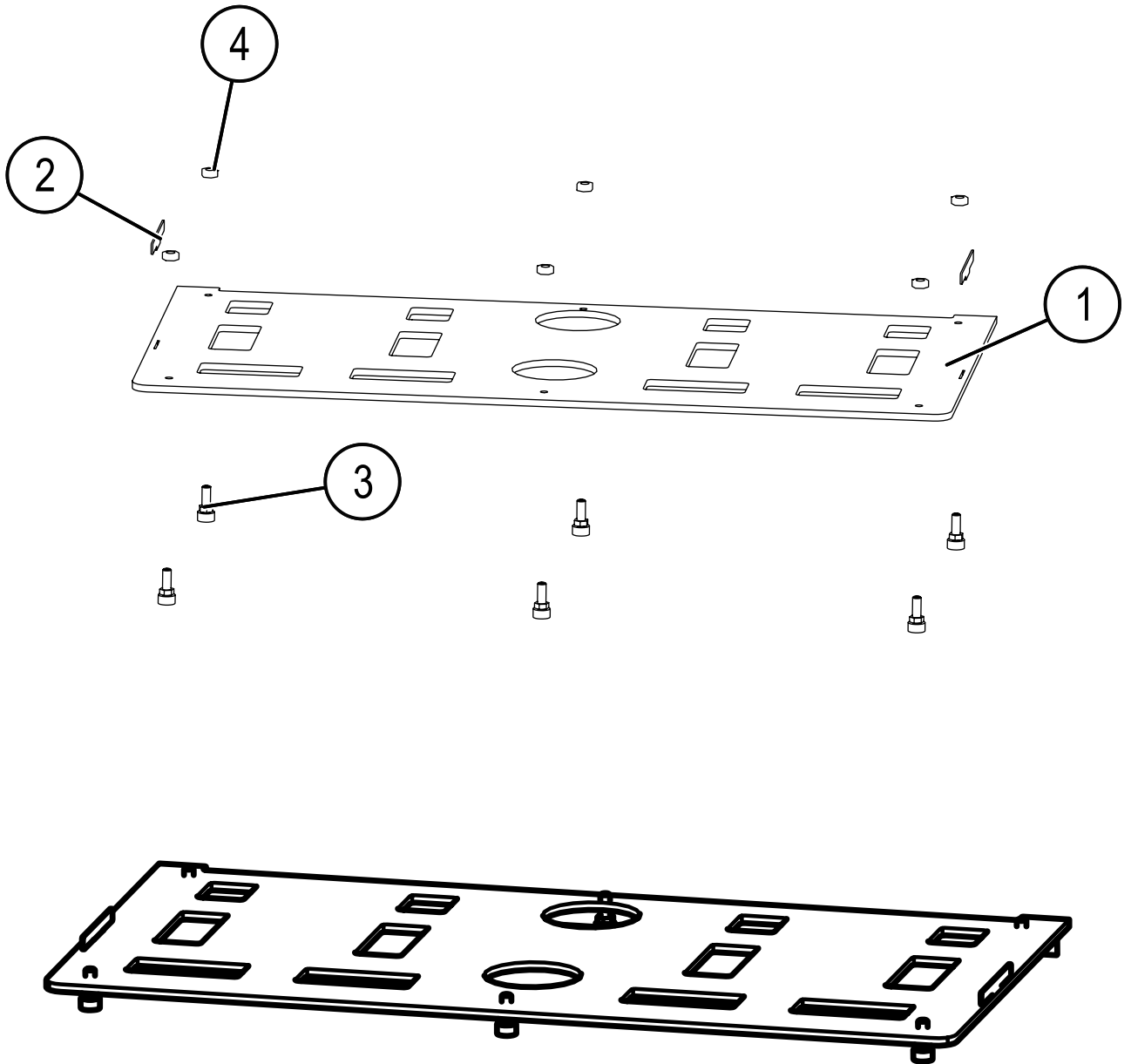
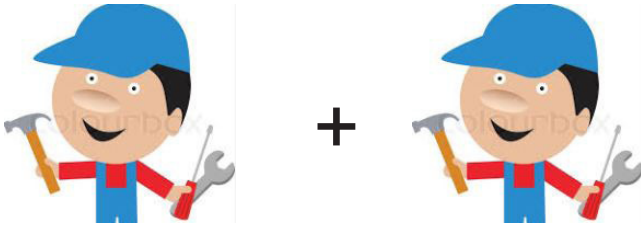

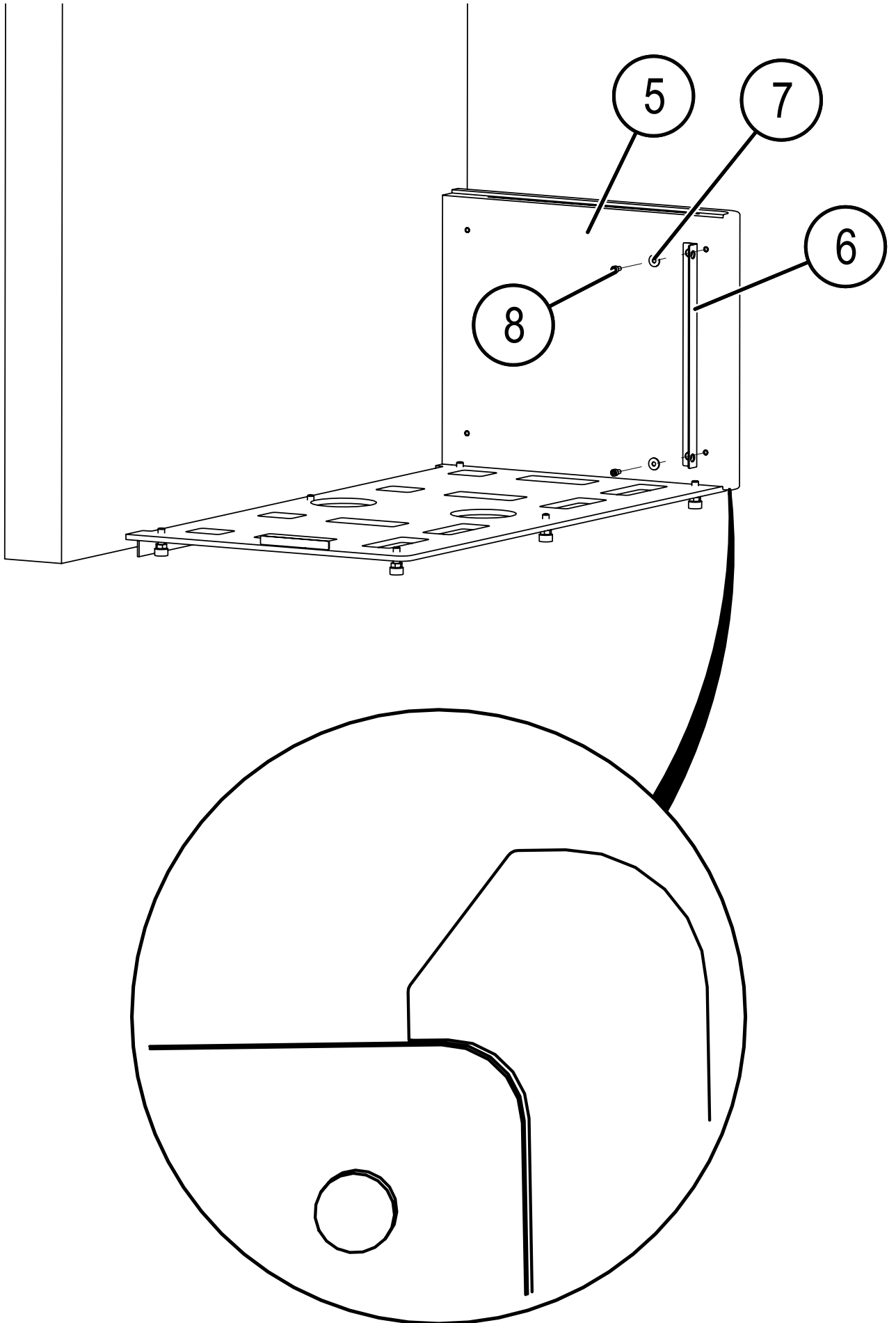

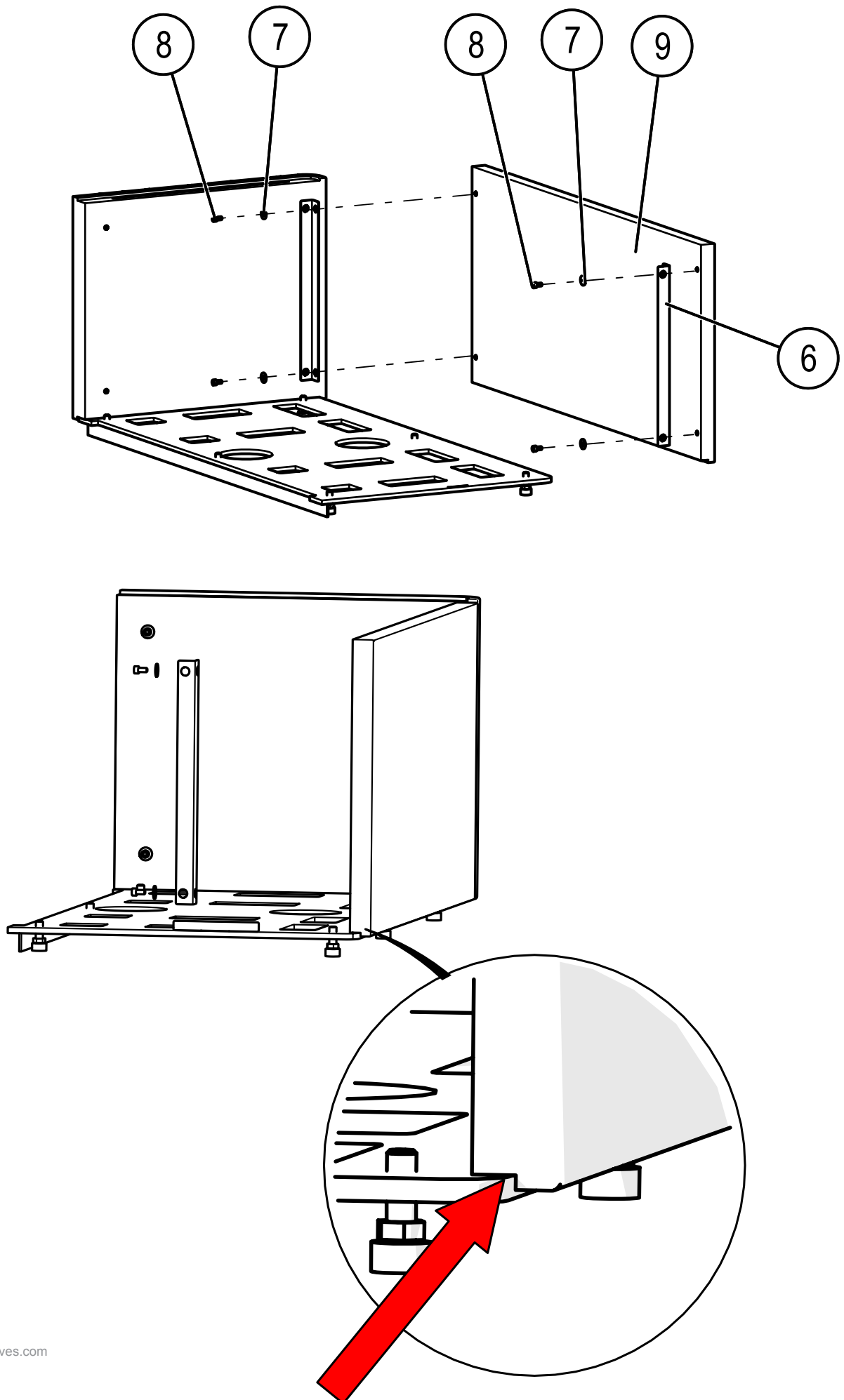

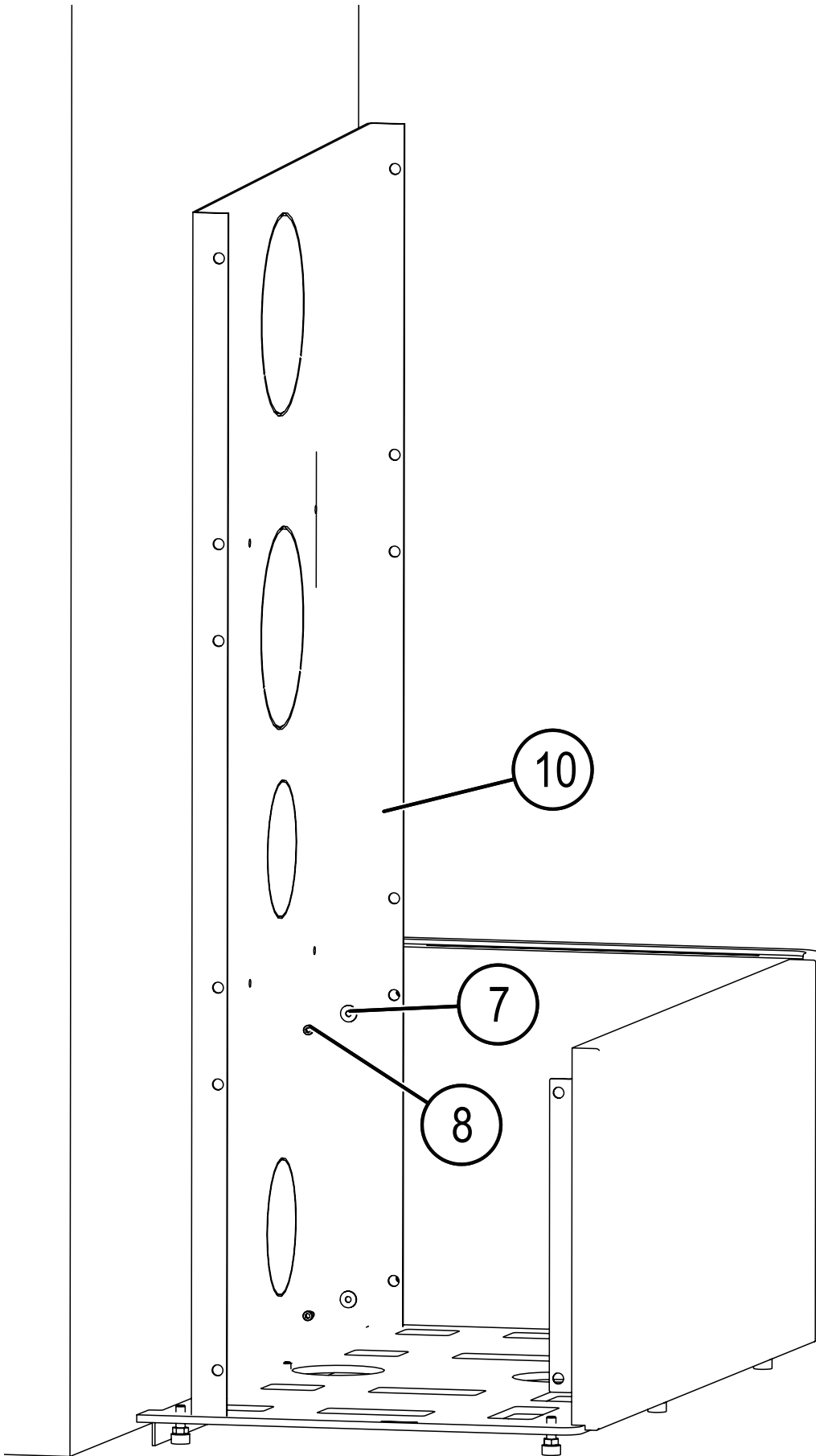

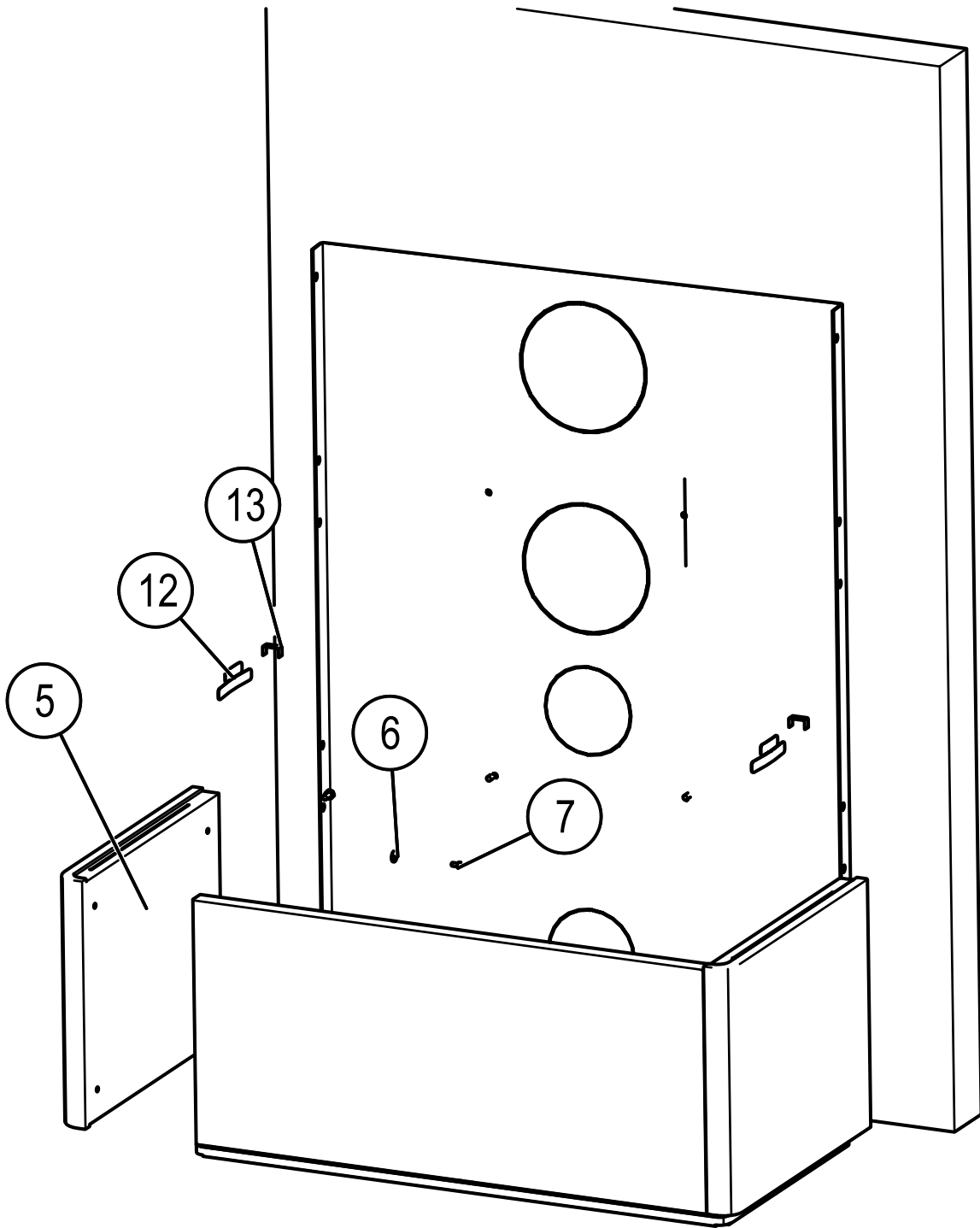

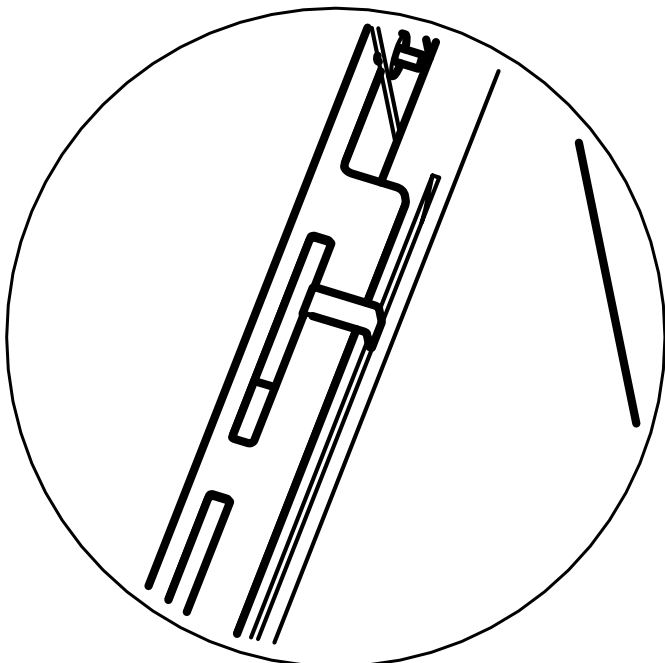
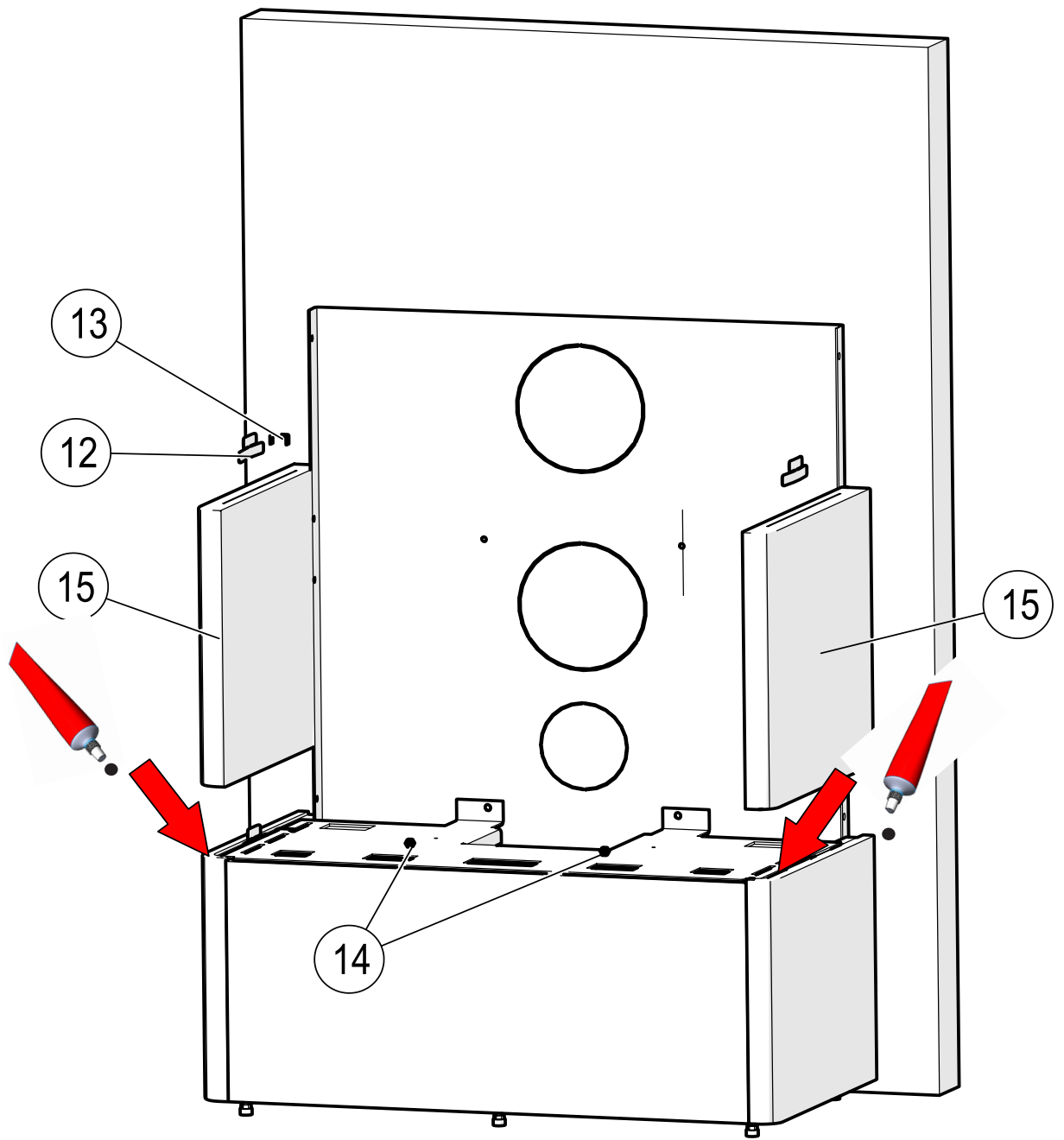

H470W

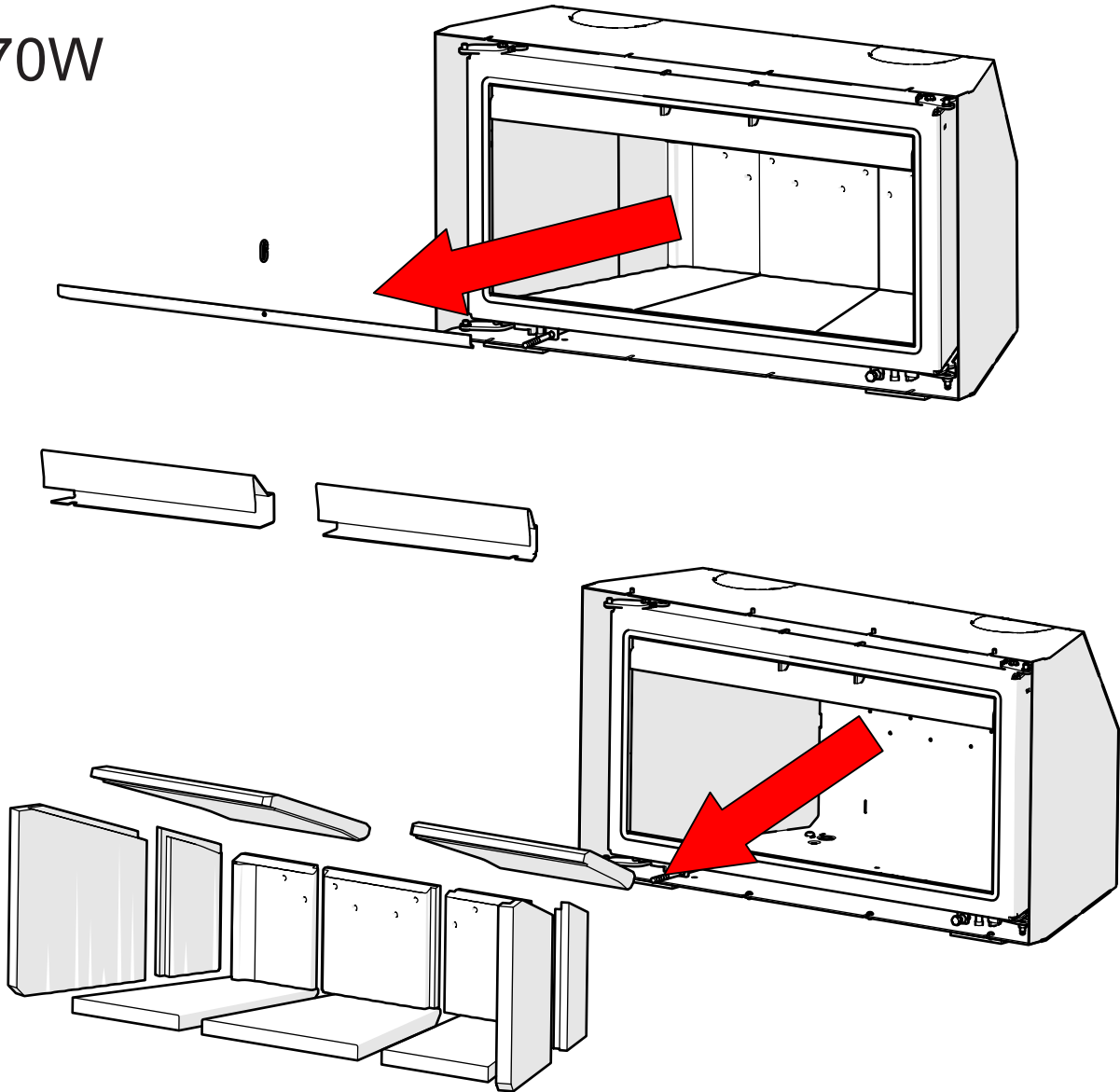

H470

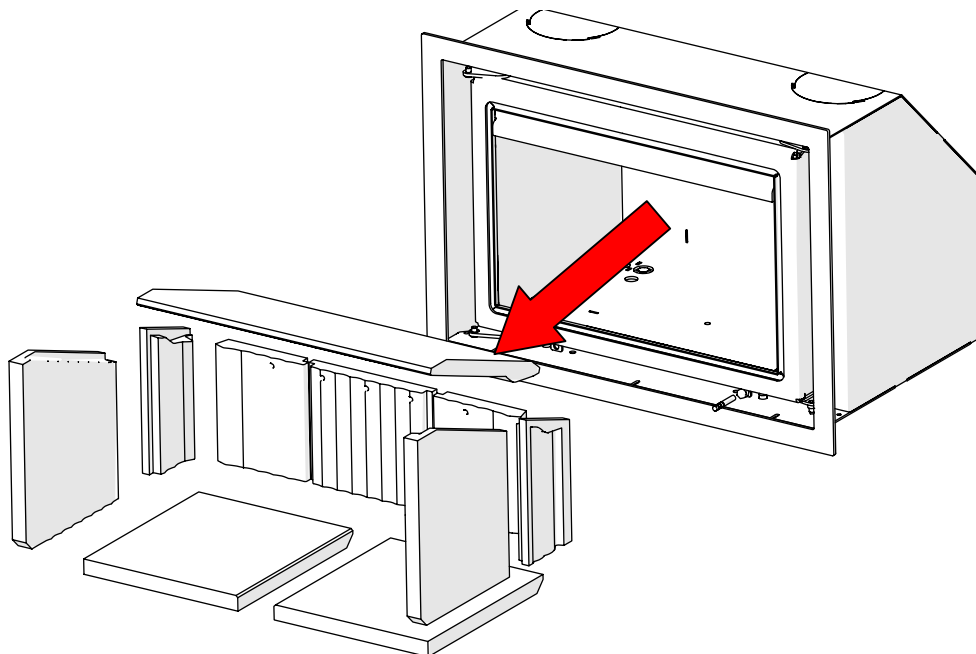

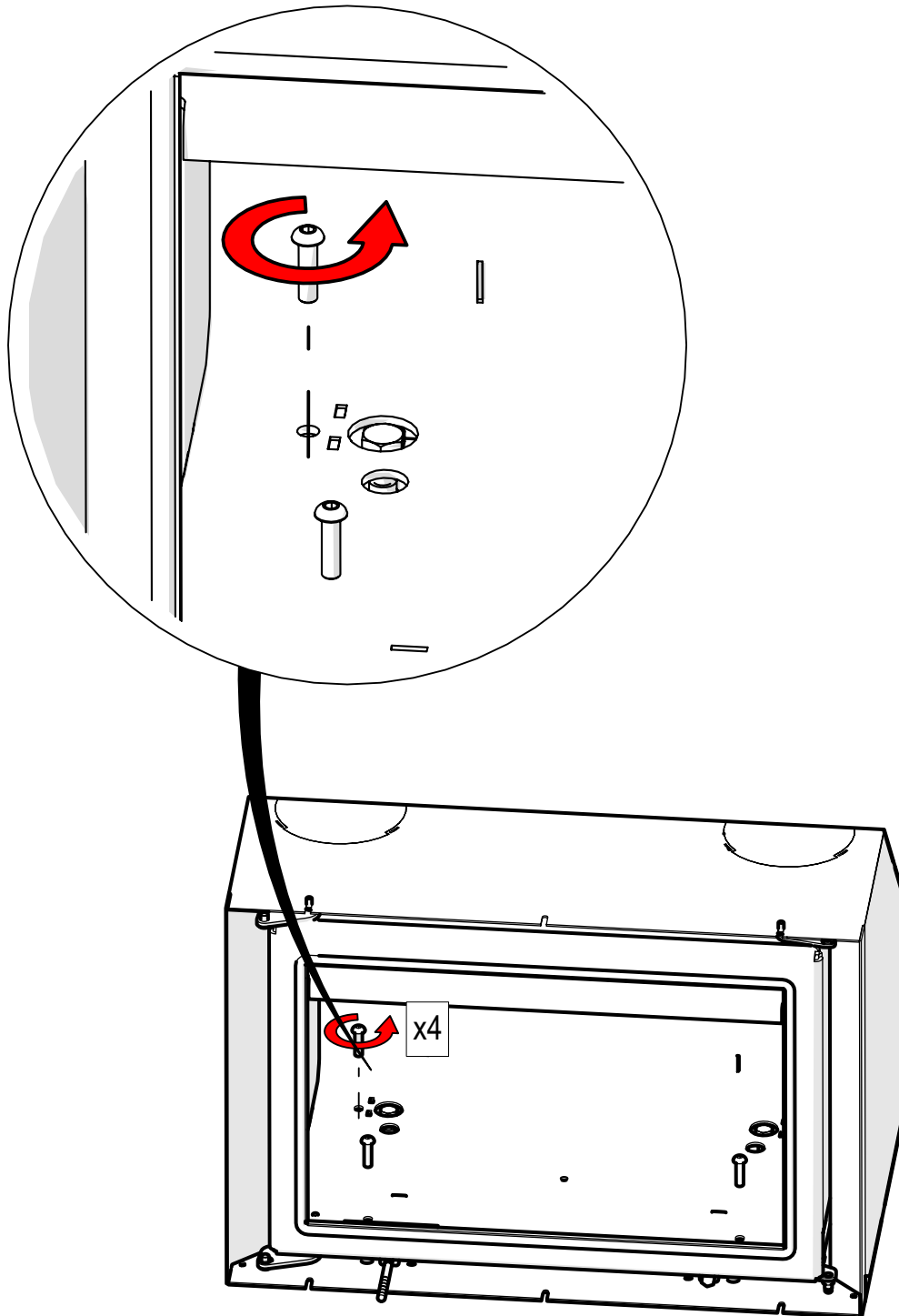

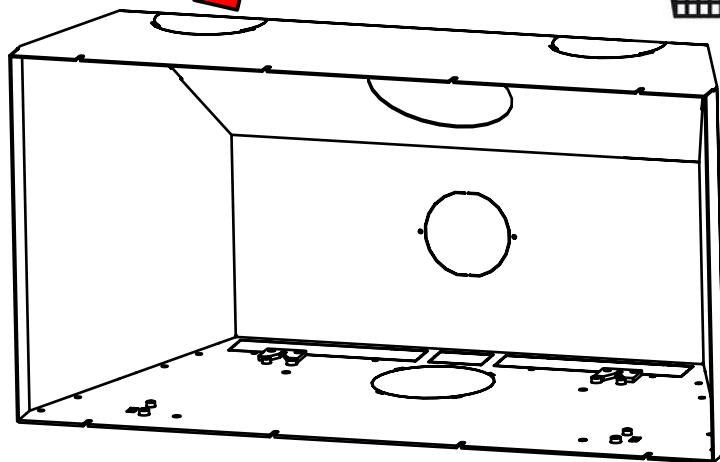
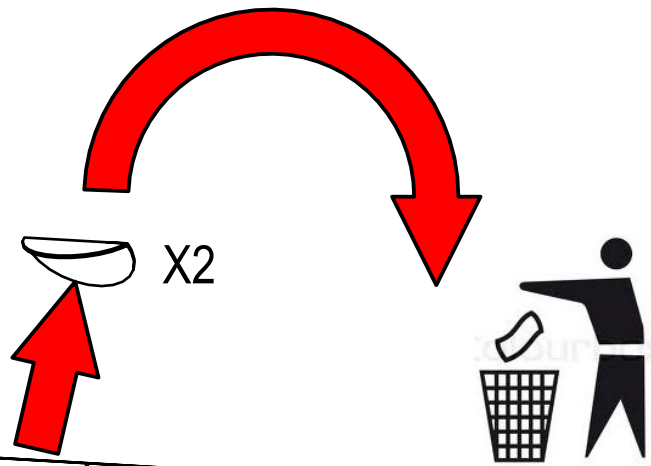
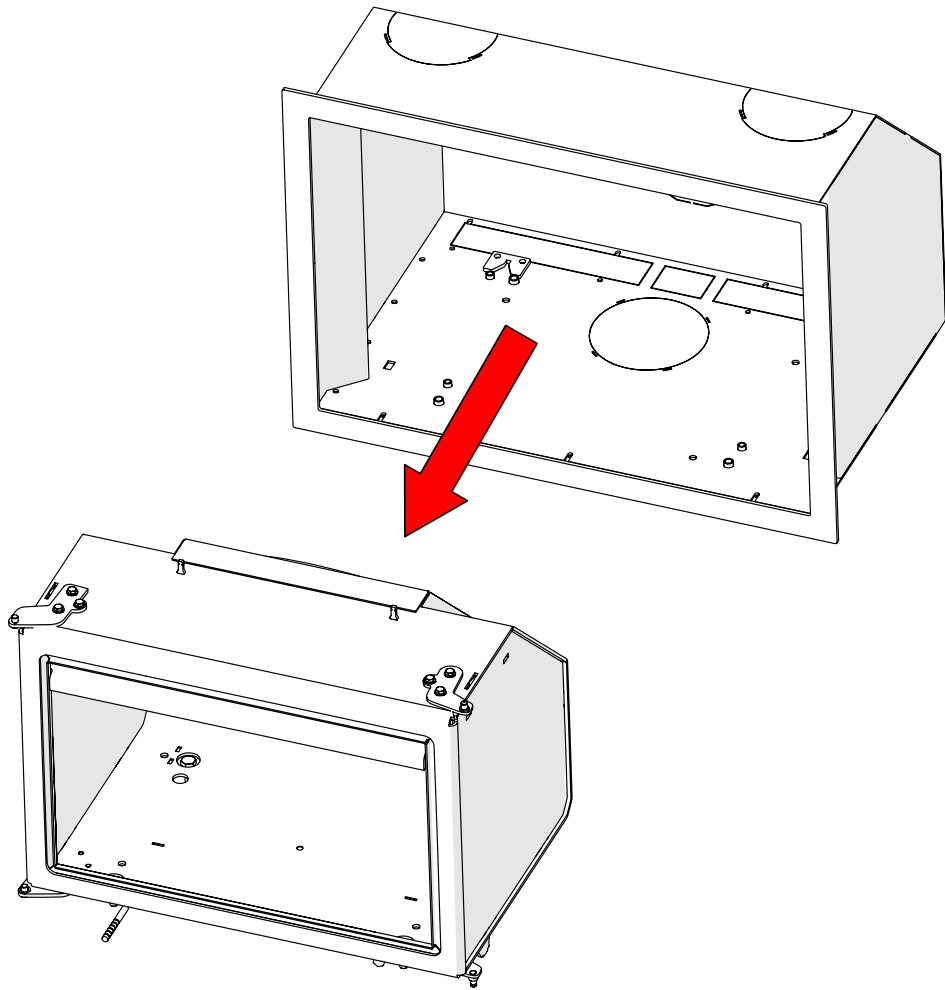

Option H307

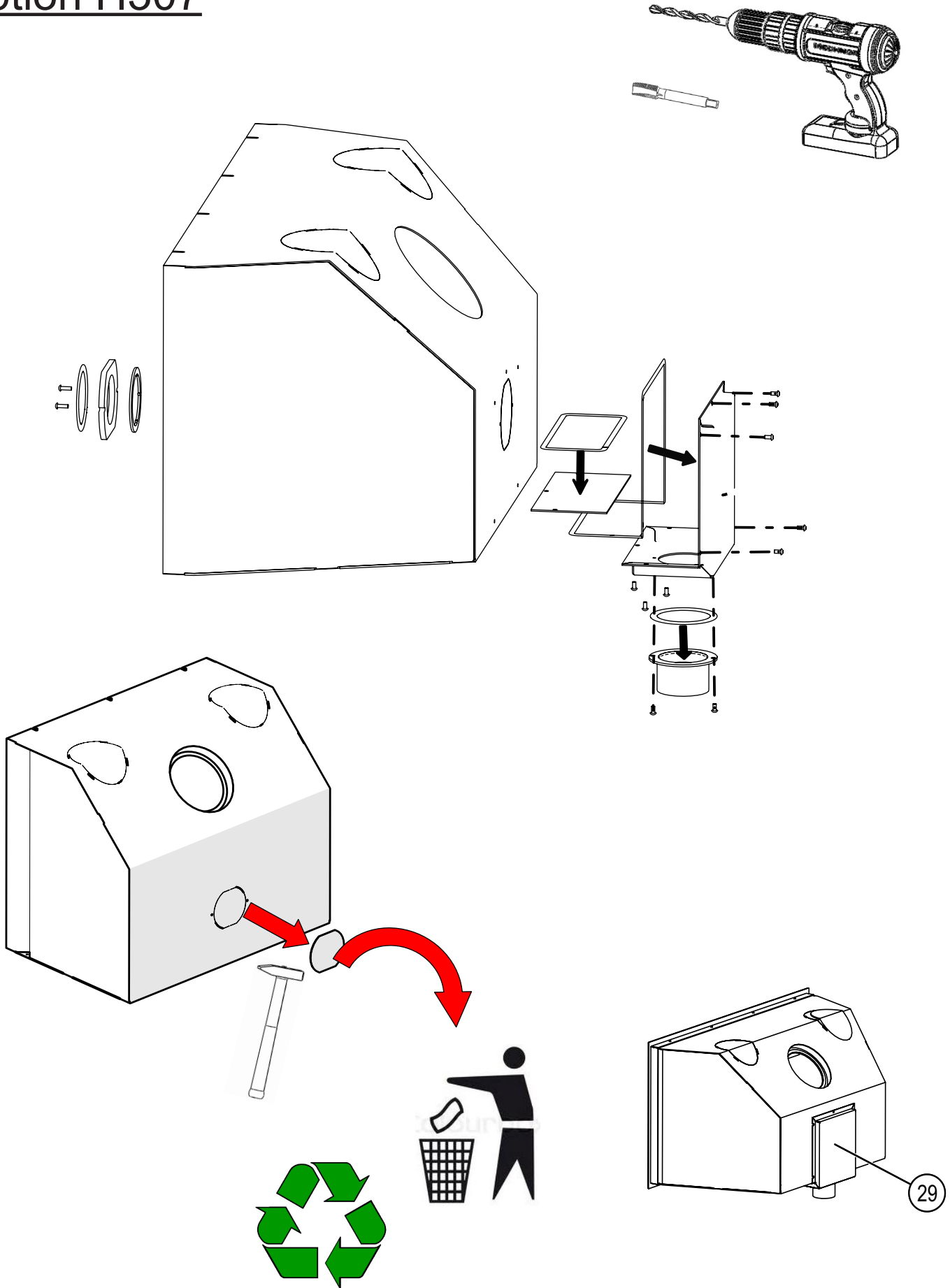

Option H307

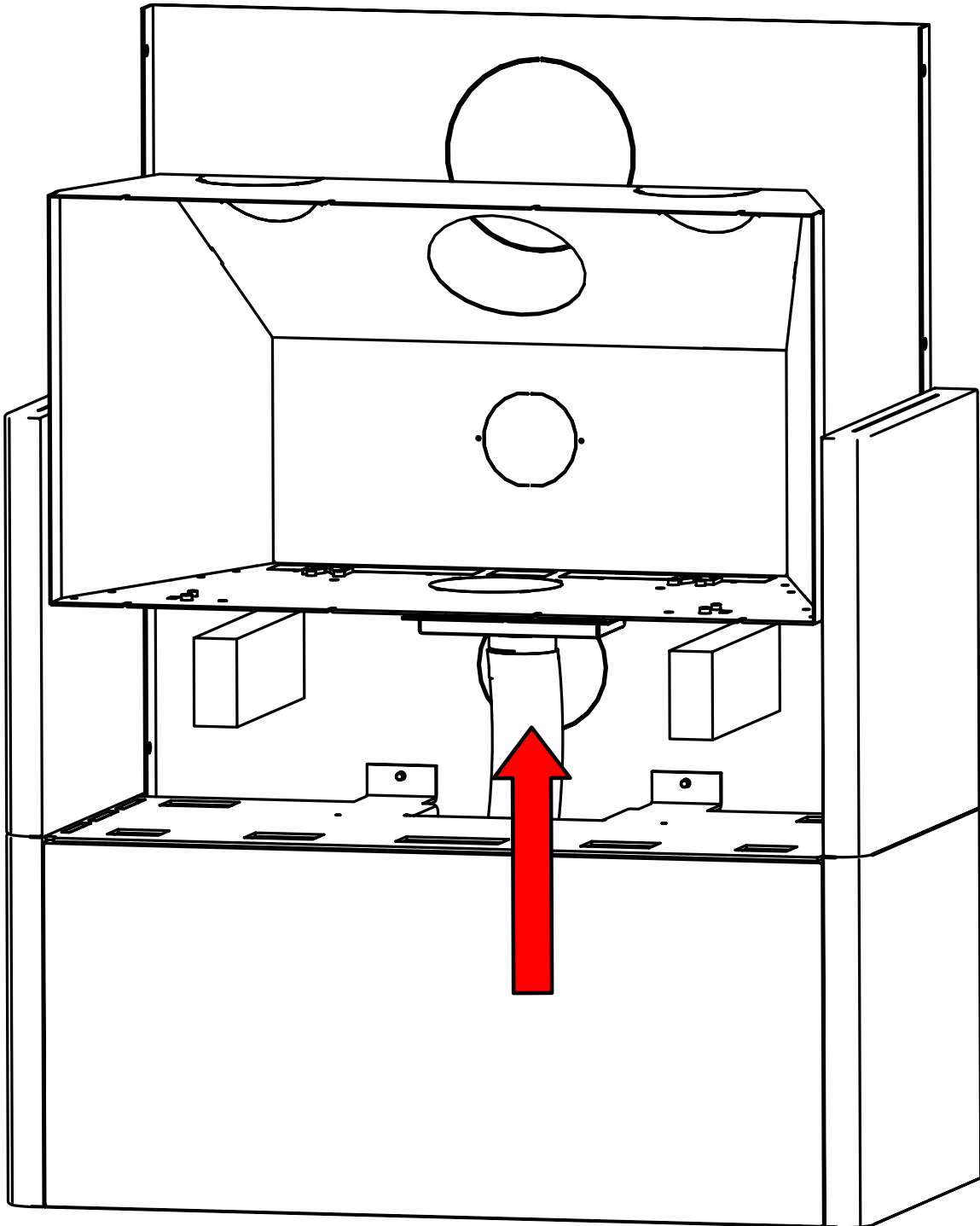

H470

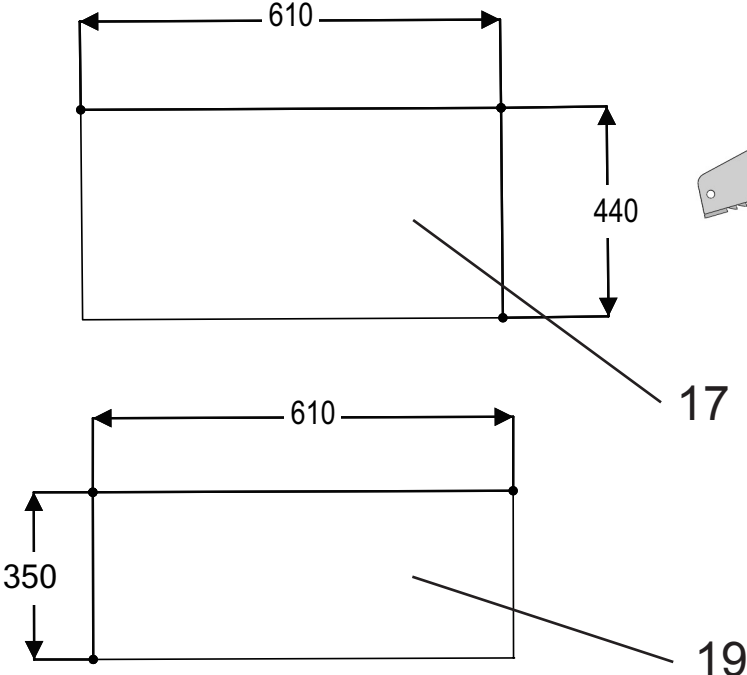

H470W

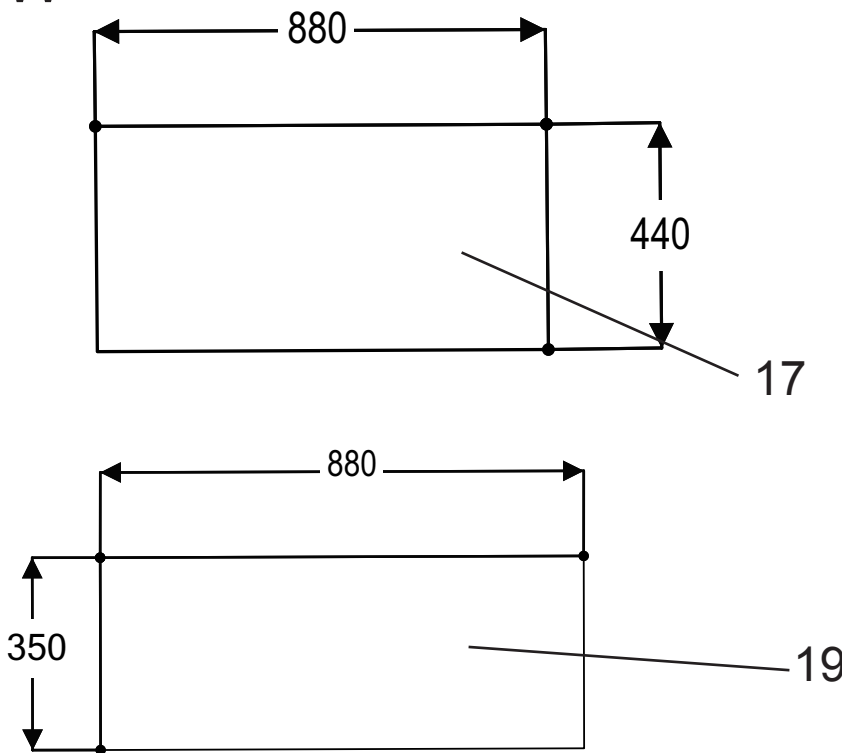

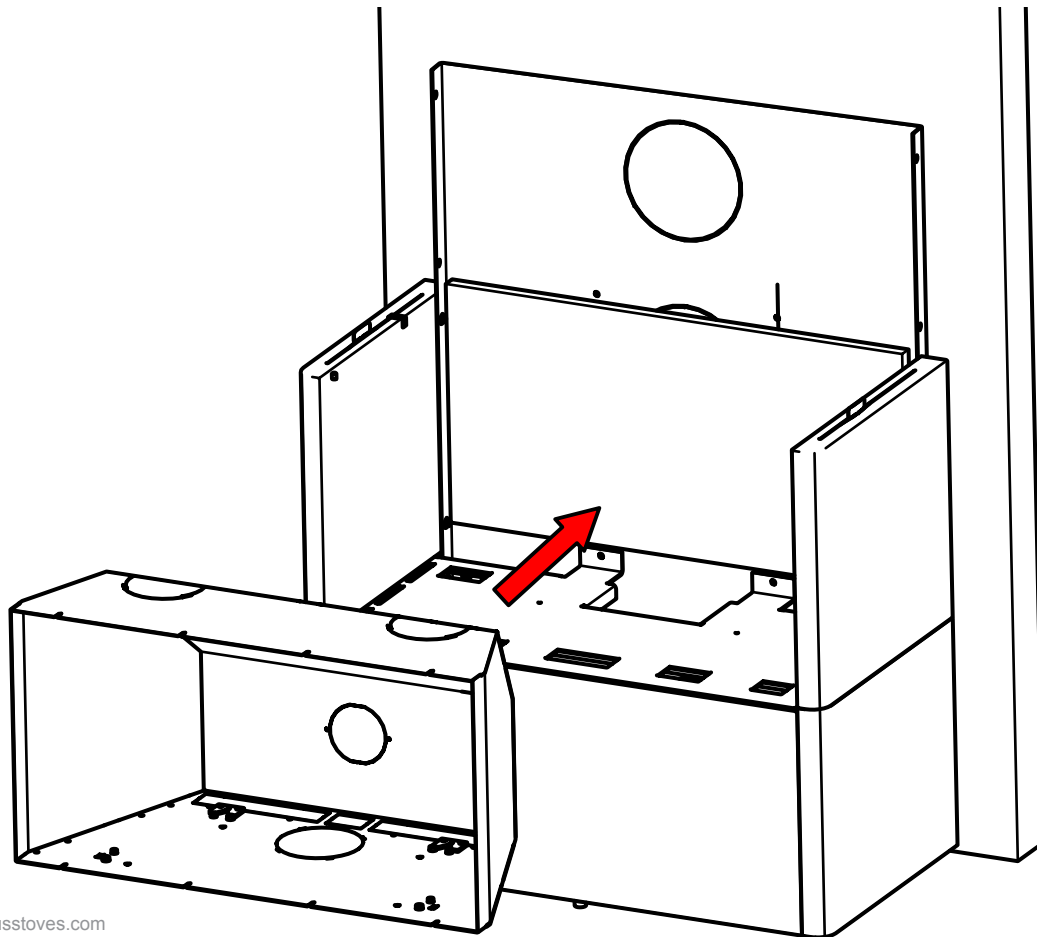
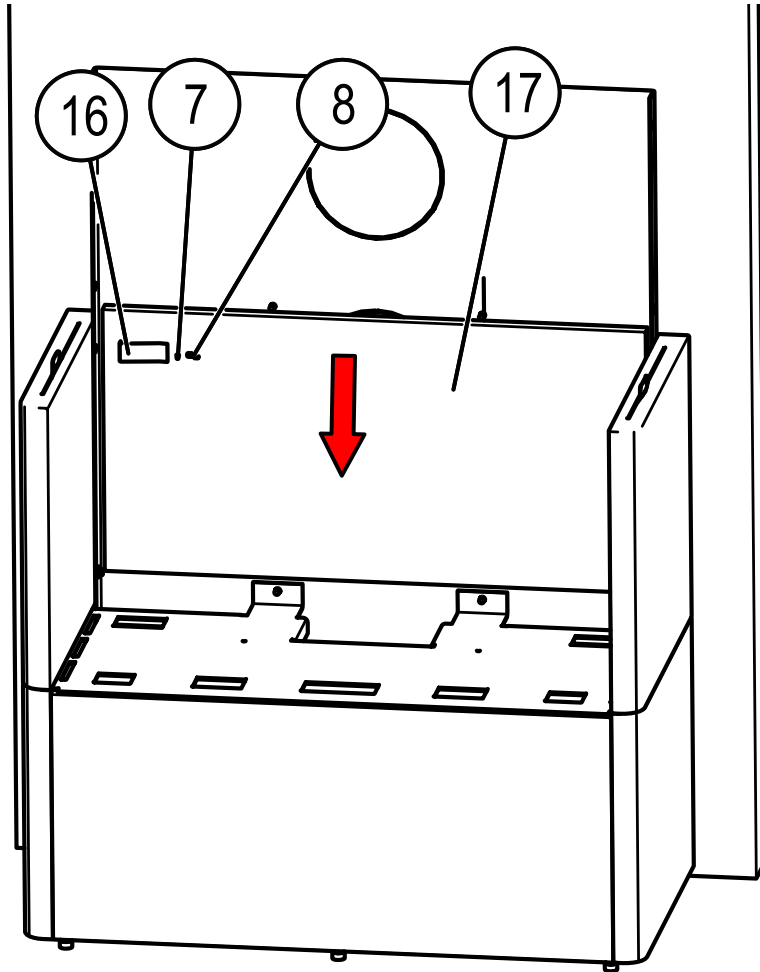

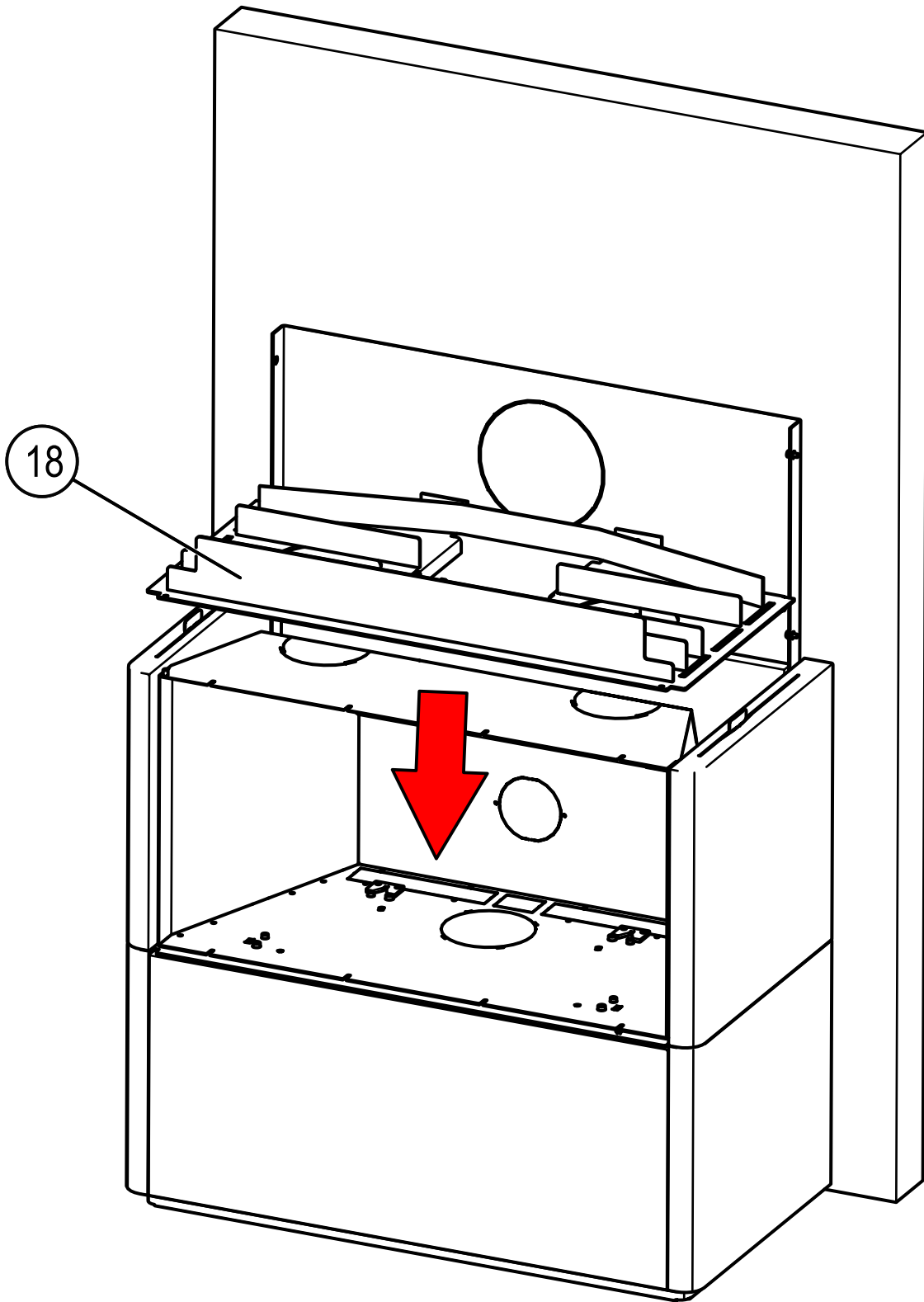

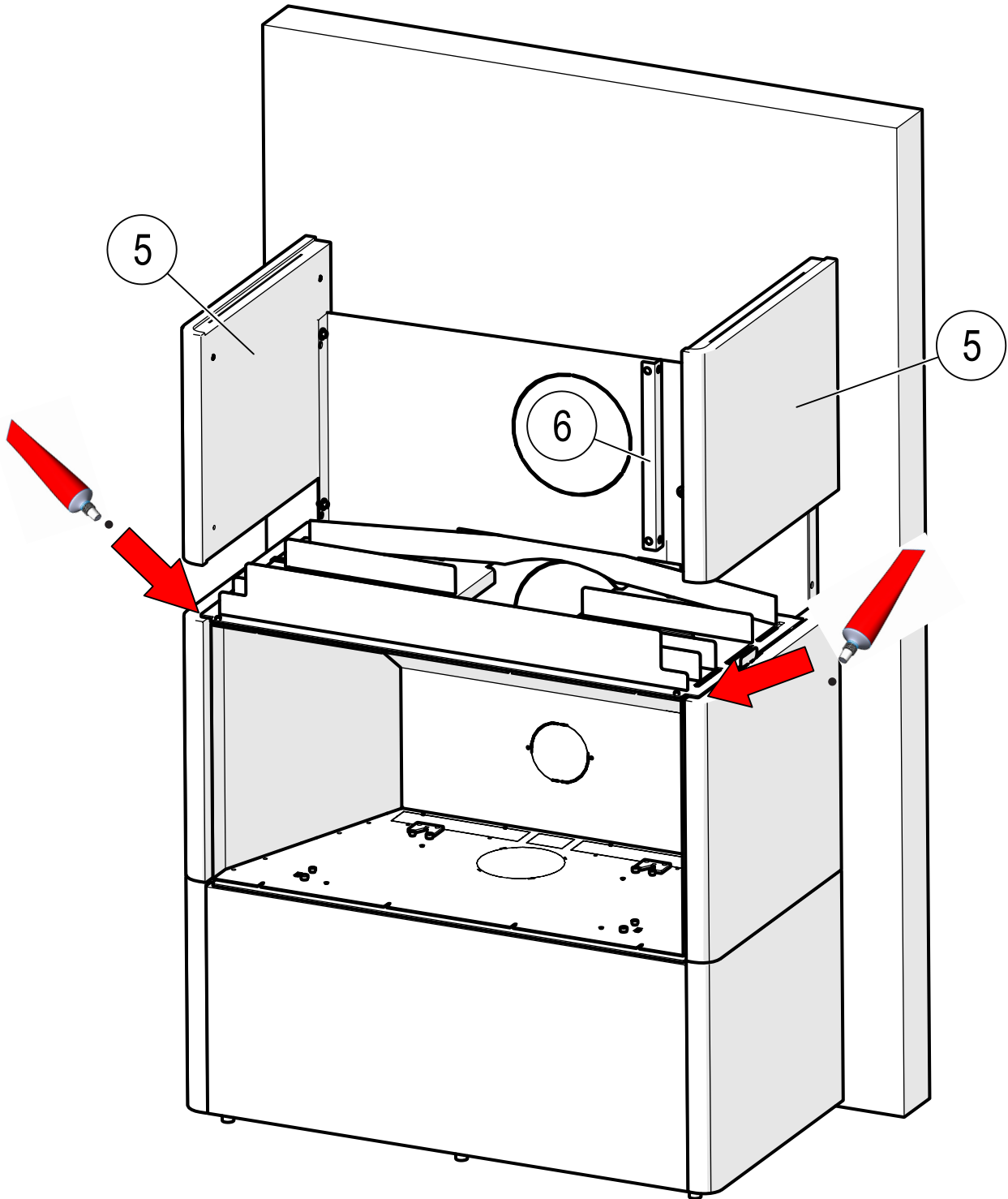

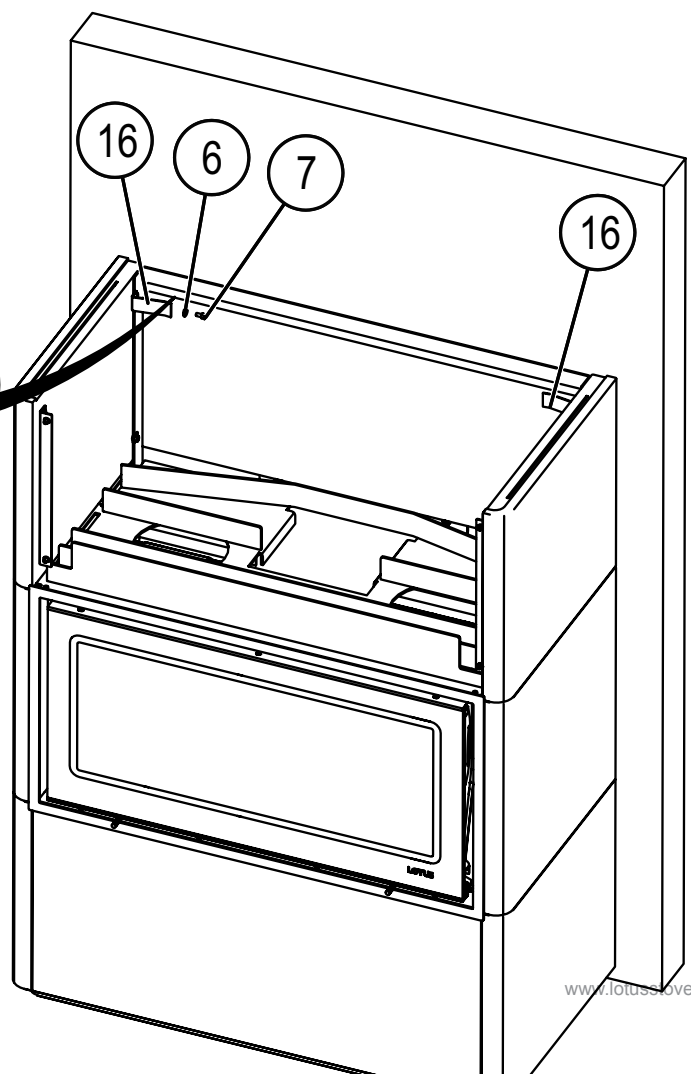
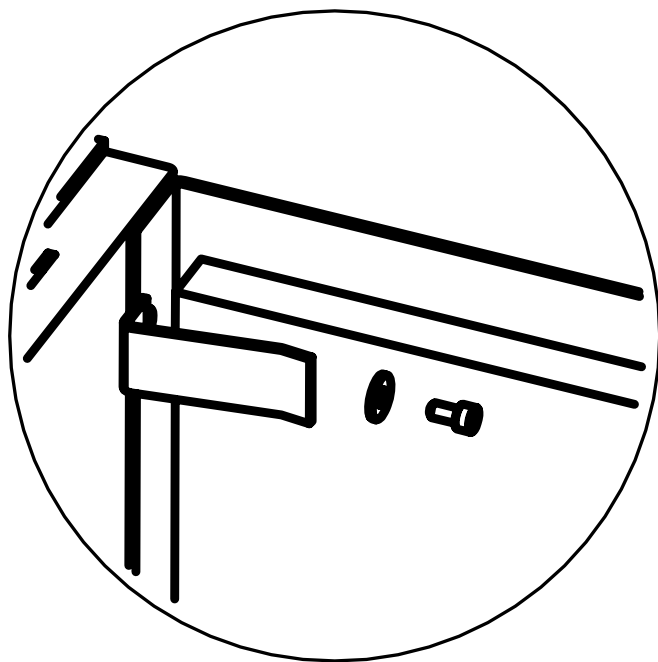
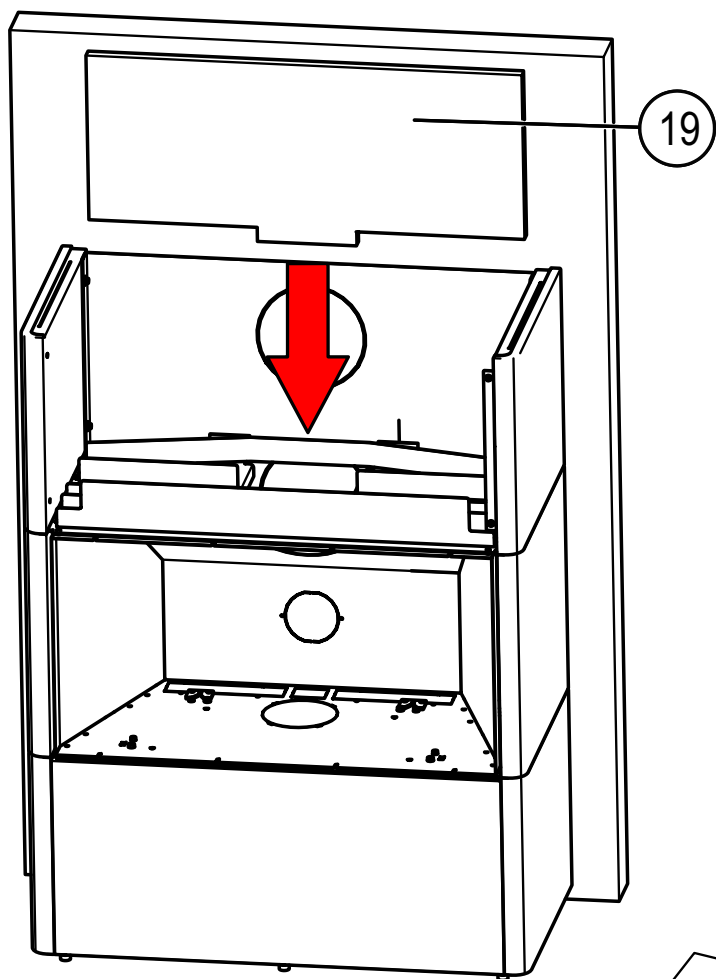

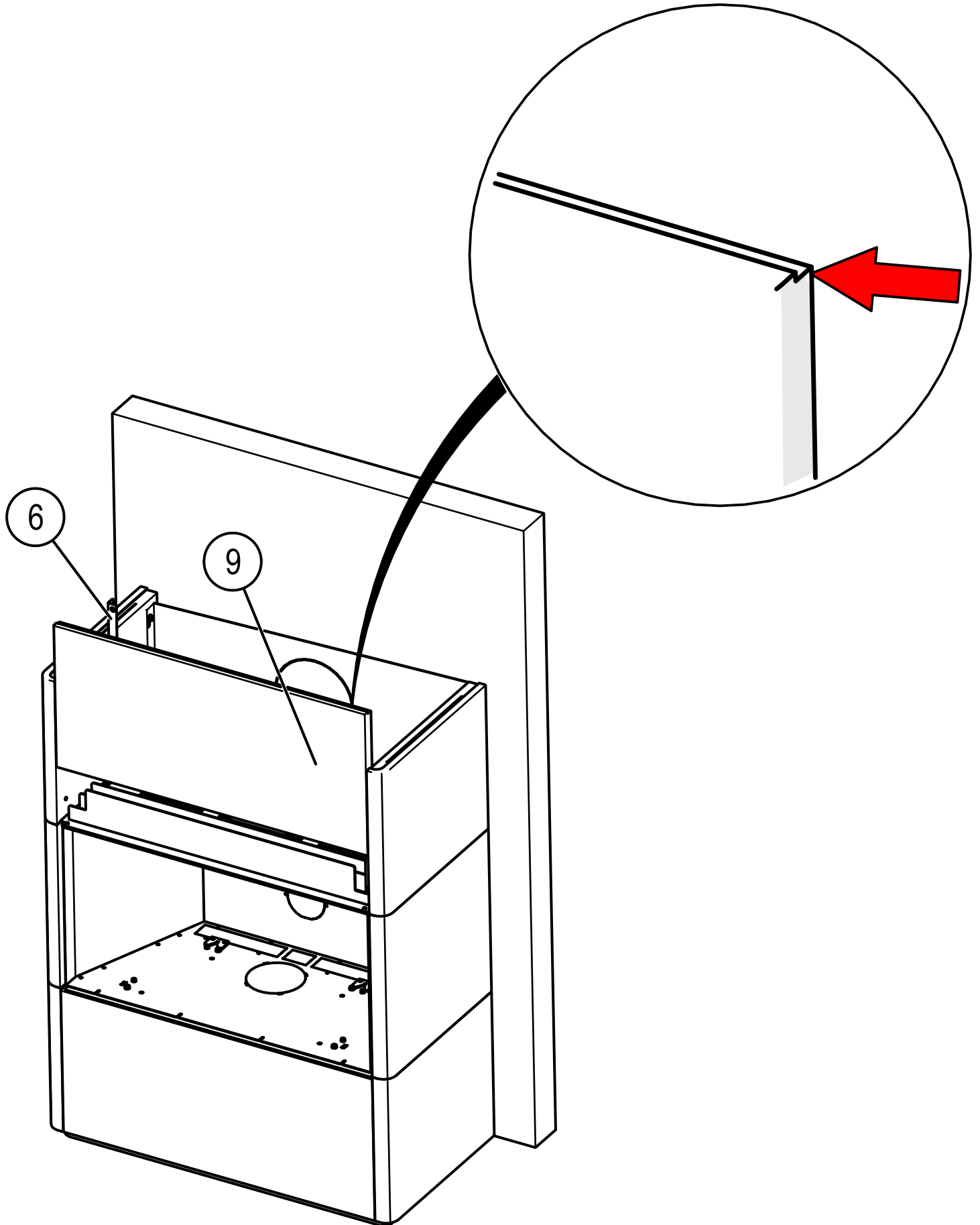

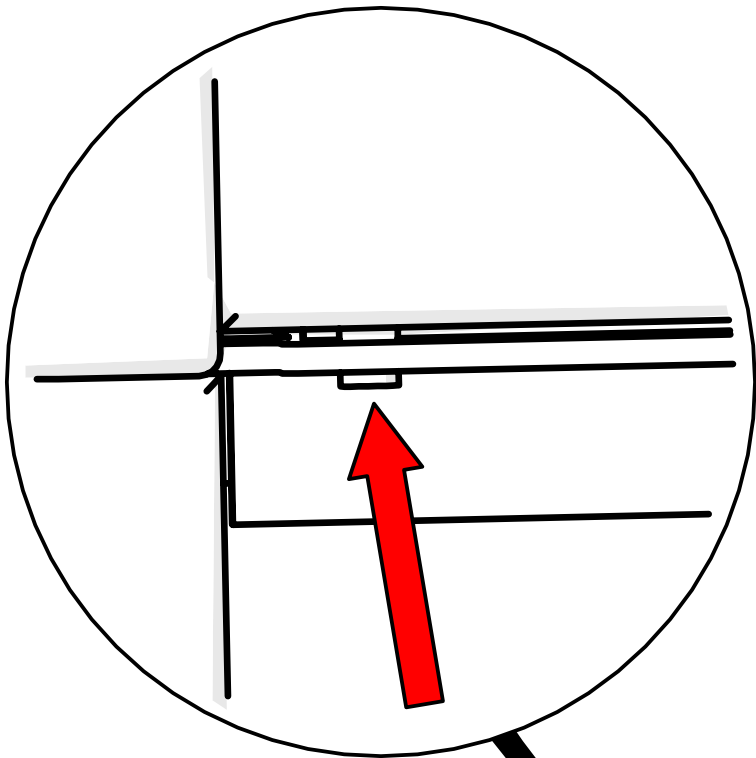

20

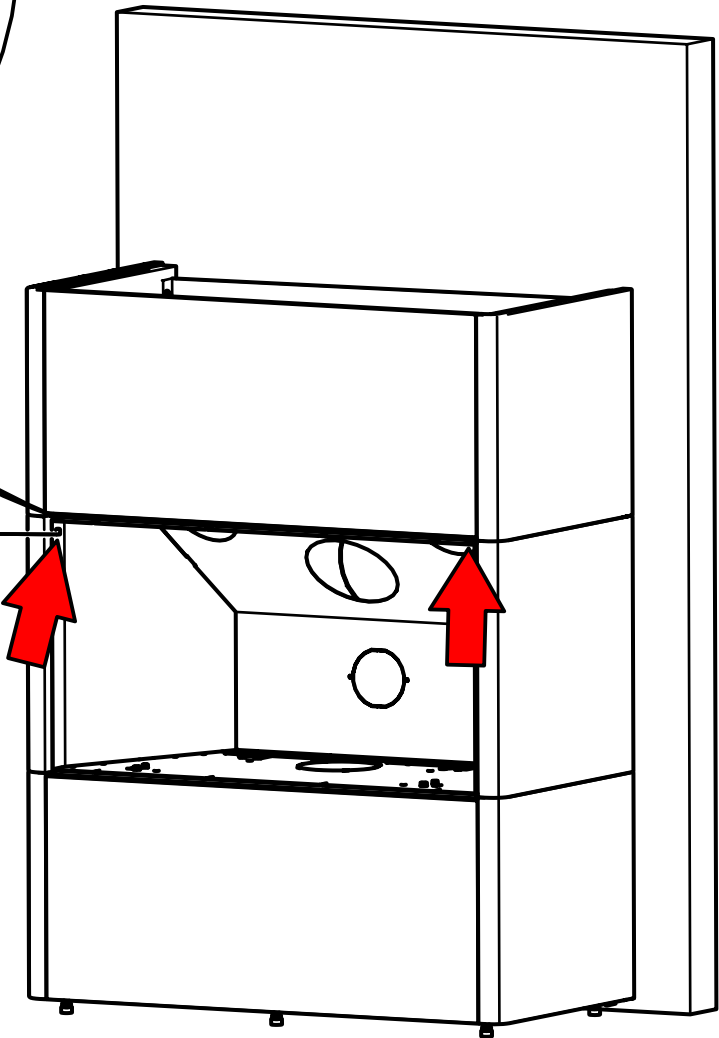

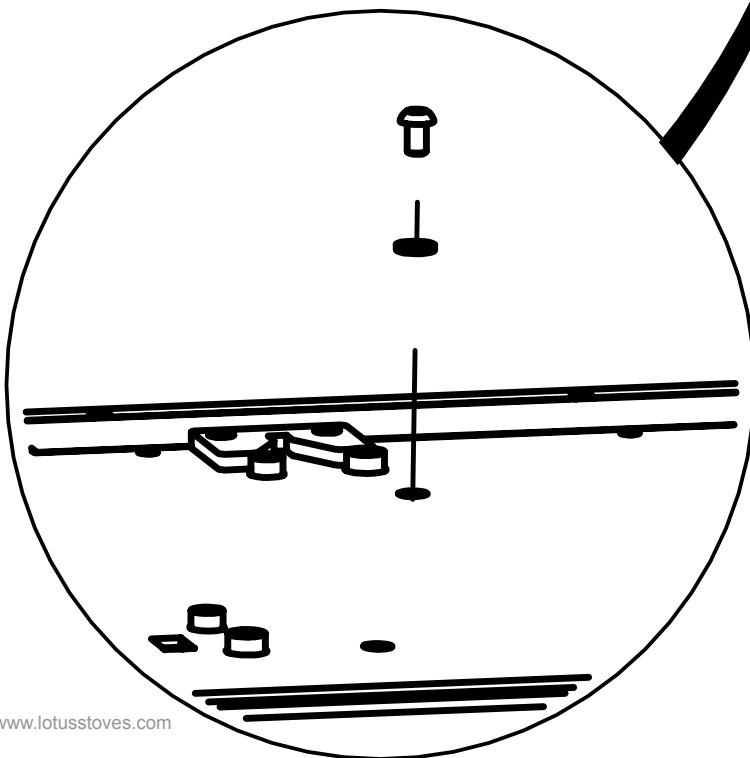
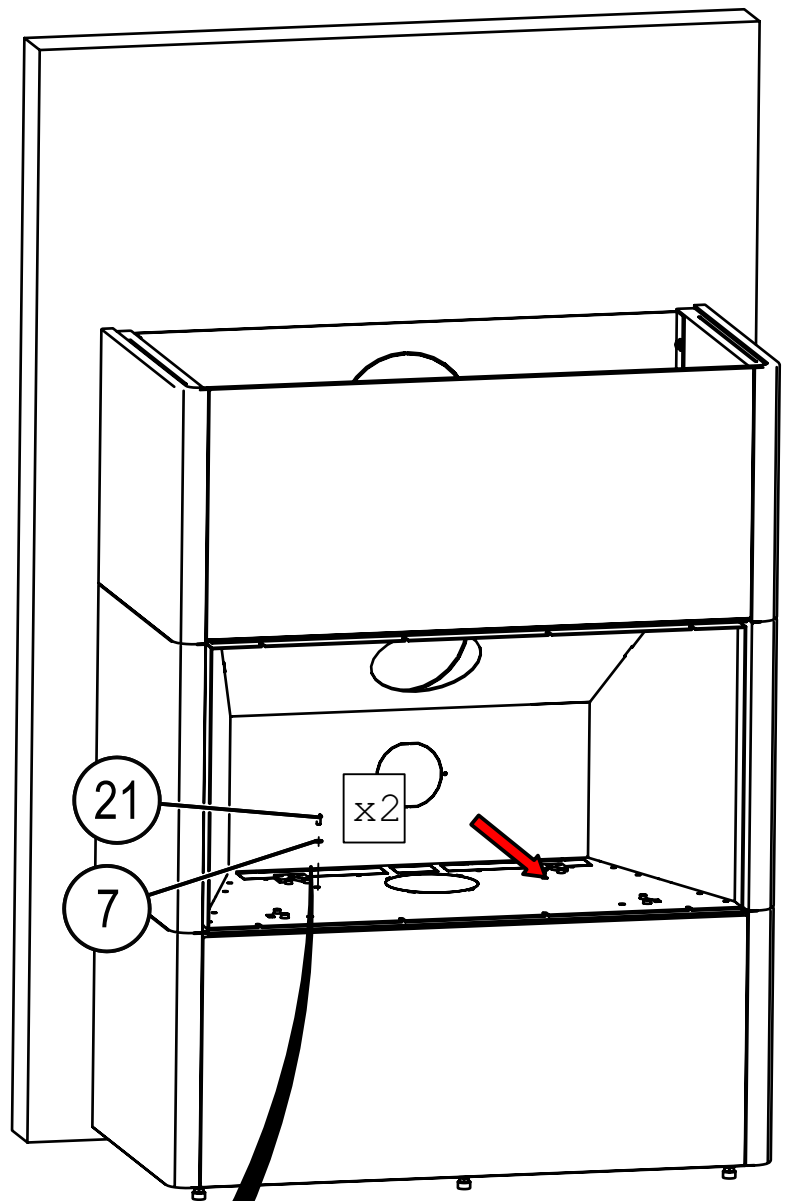

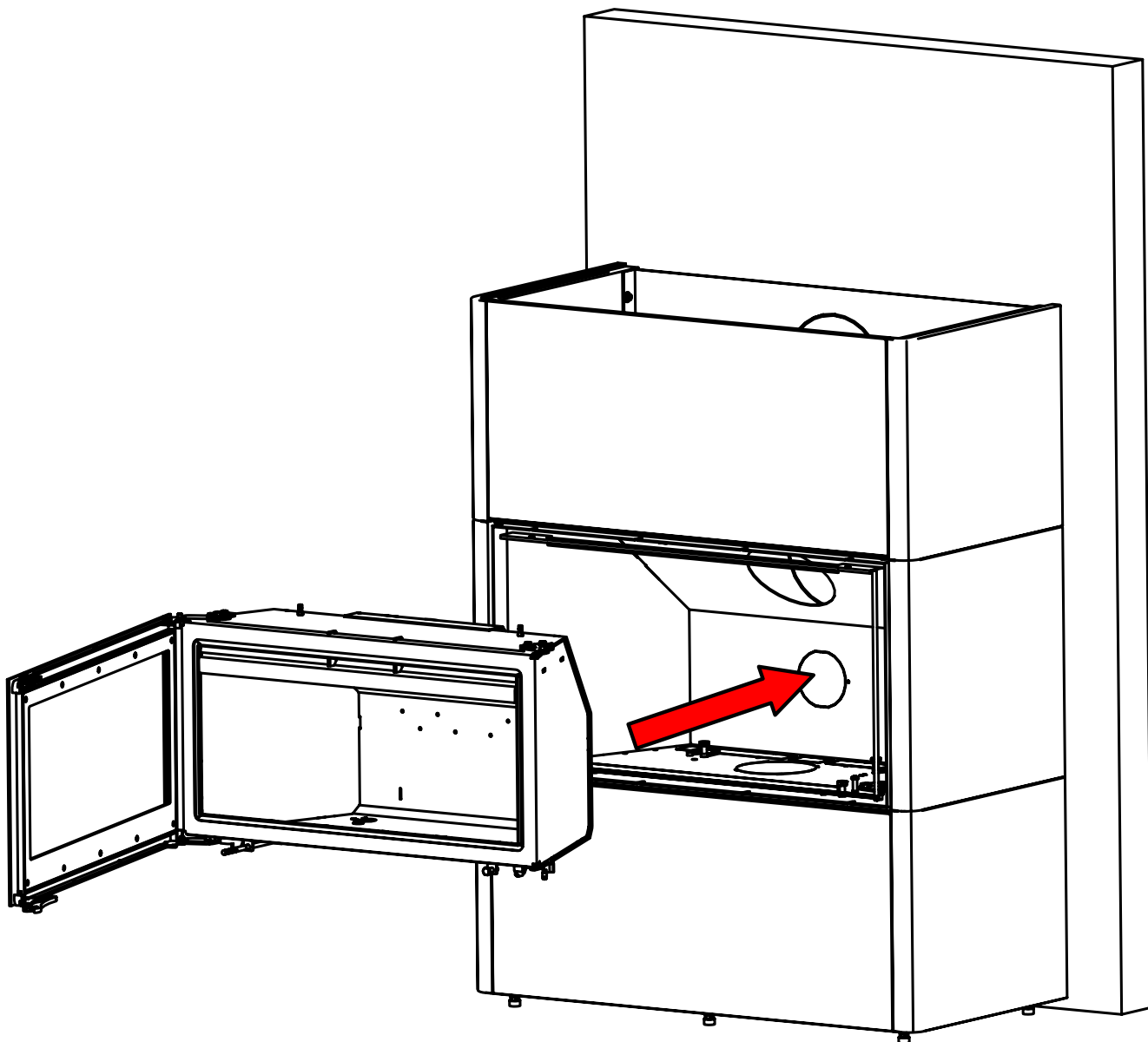

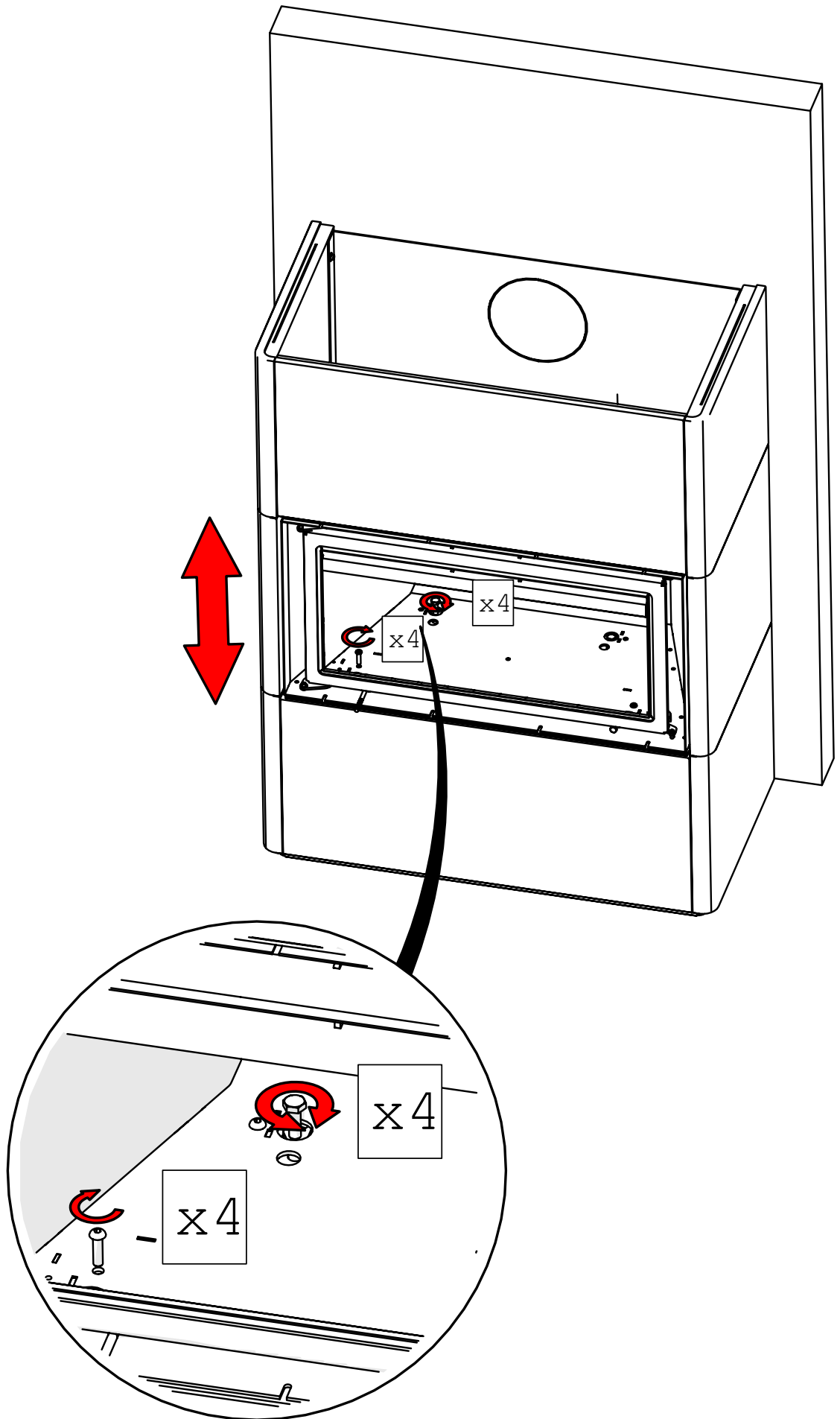

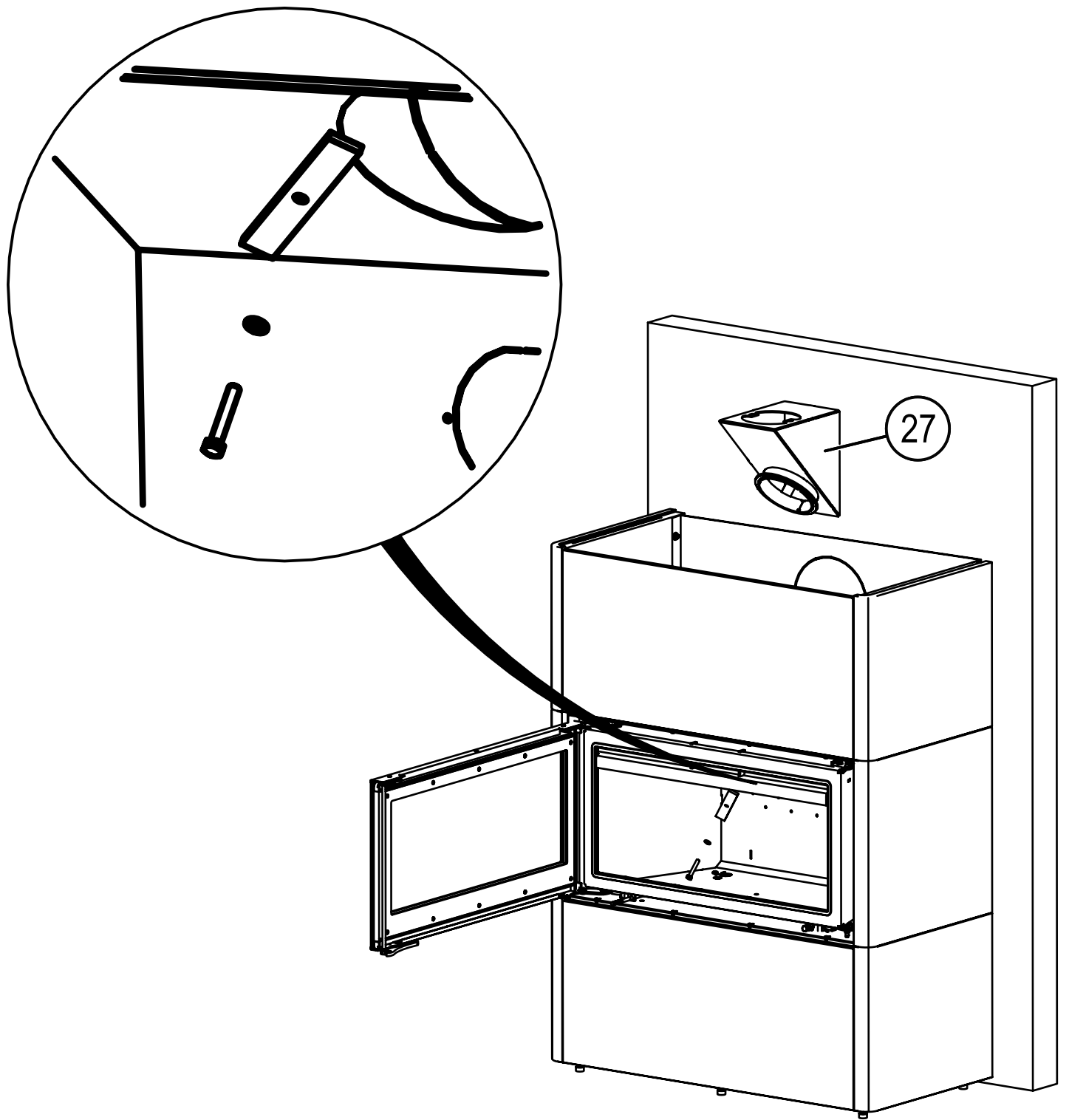

H470W

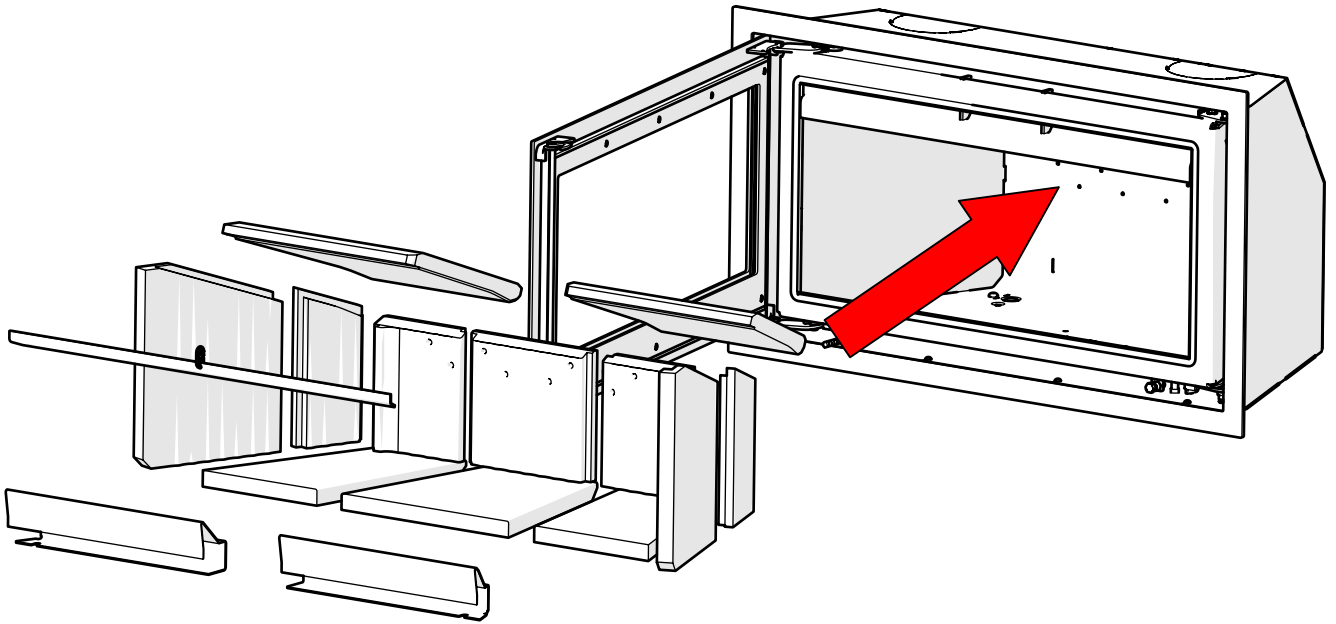

H470

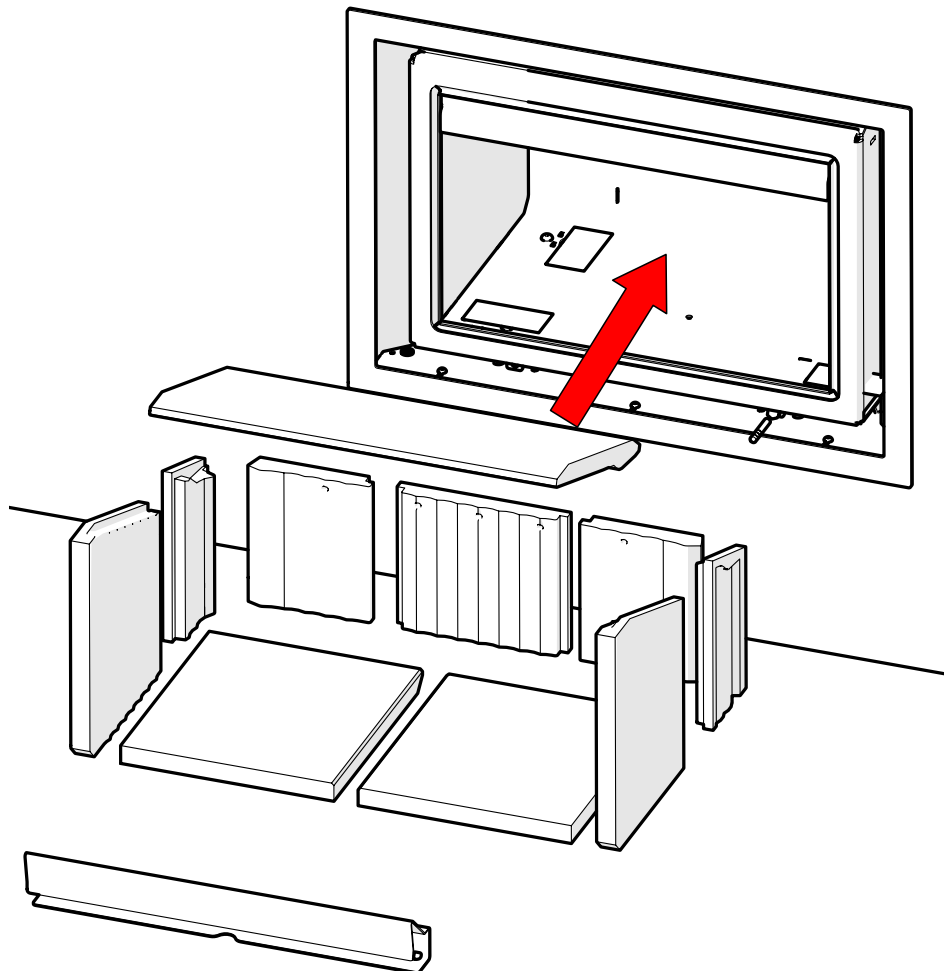

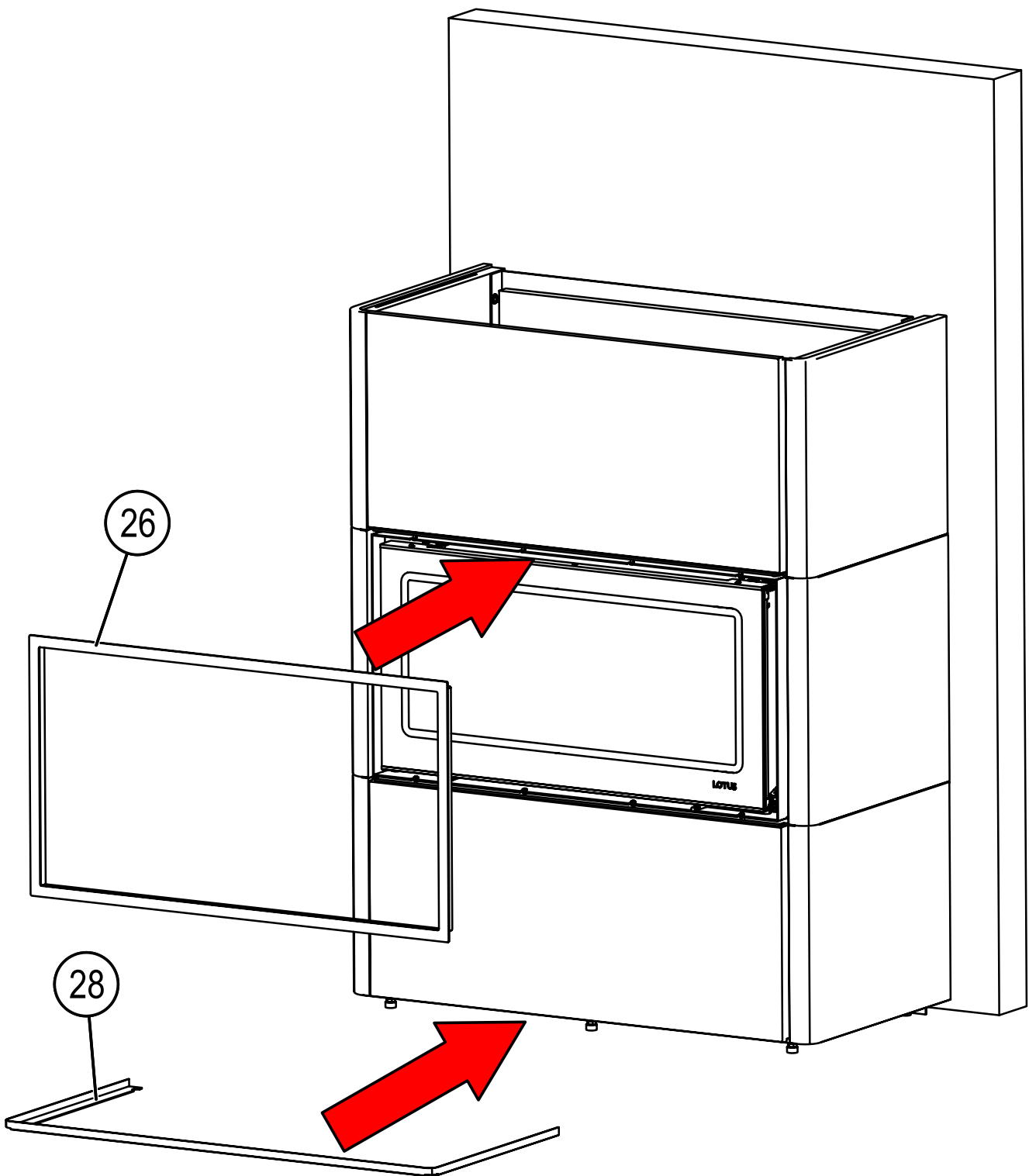

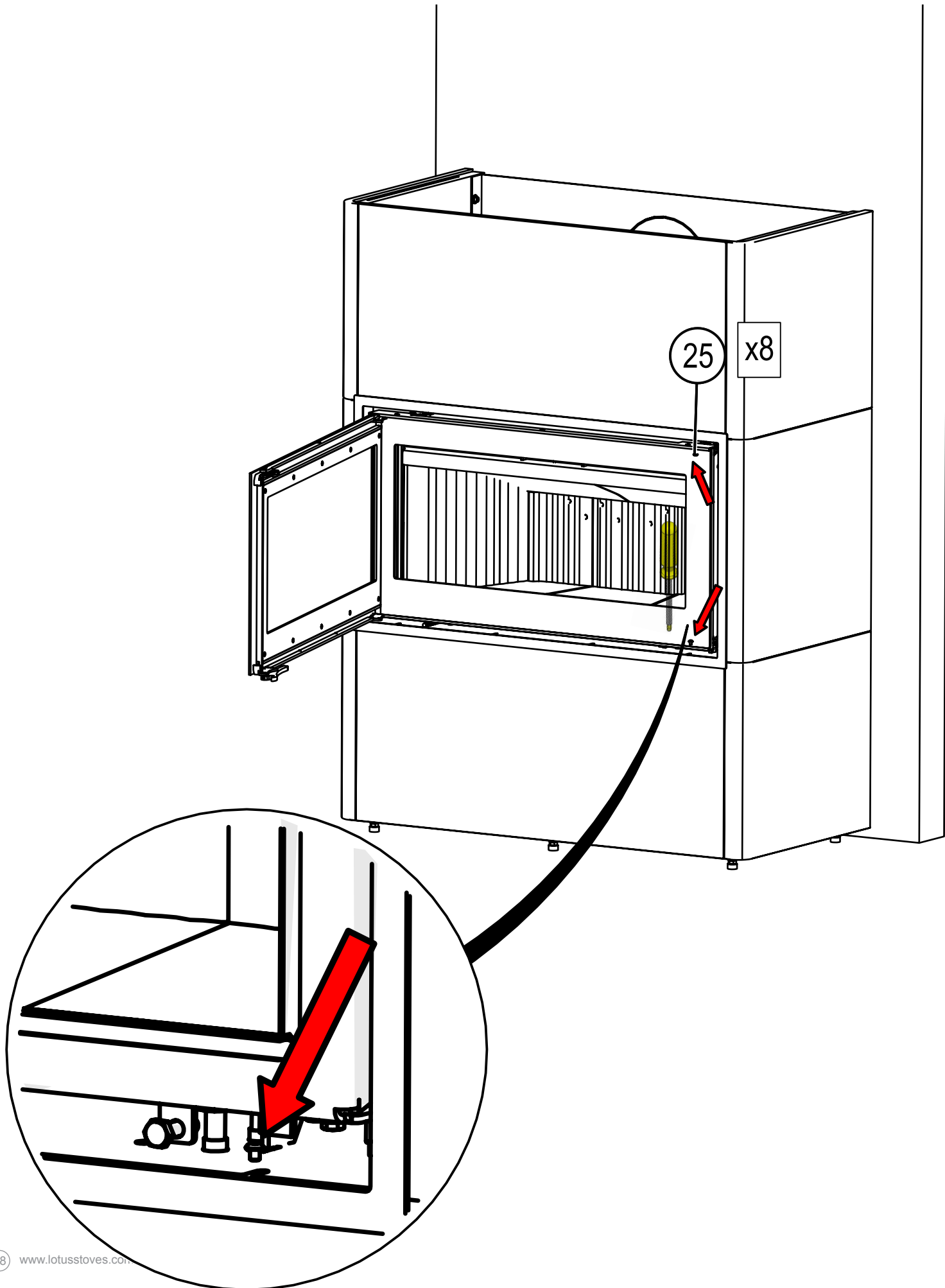

H470

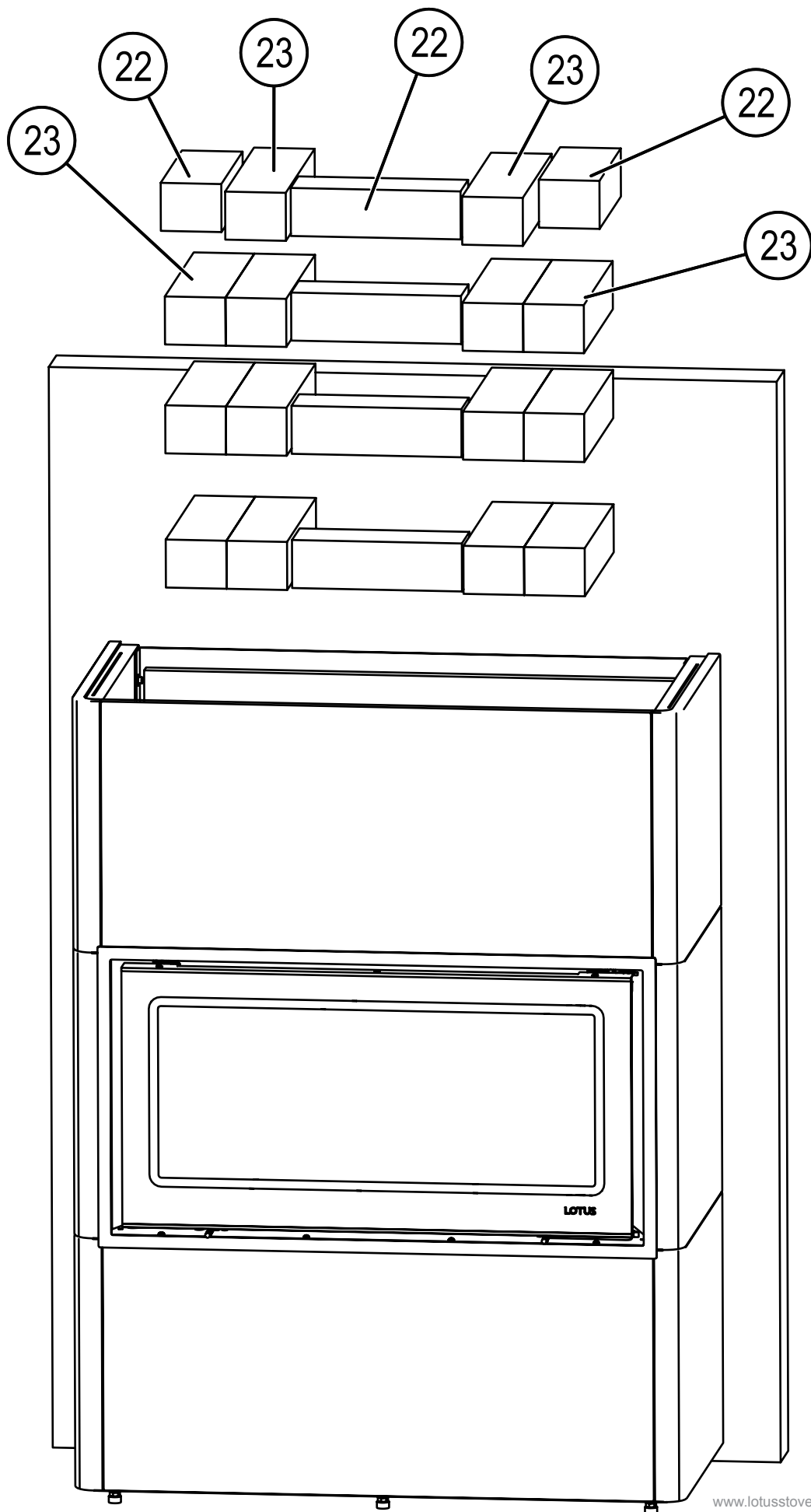

H470W

