

TBparts Stage 1 Clutch – CRF110

For ease of installation, we recommend following steps 1-3 first:

1. Drain the engine oil.
2. Remove peg bar and skid plate if equipped.
3. Move the rear brake pedal out of the way. Remove the kick starter too.

Now, with everything out of the way.

4. Start by taking the nut off the clutch adjuster bolt in the center of the clutch cover. This makes removing the cover easier.
5. COMPLETELY remove all 10 case bolts holding the clutch cover on.
6. Remove clutch the cover.
7. The clutch lifter cam will probably fall off while you remove the cover. If not remove that.
8. Remove the clutch lever off the shift shaft.
9. Remove the 3 bolts holding the cover plate onto the one-way clutch. This will expose the Lock nut, #20 below.

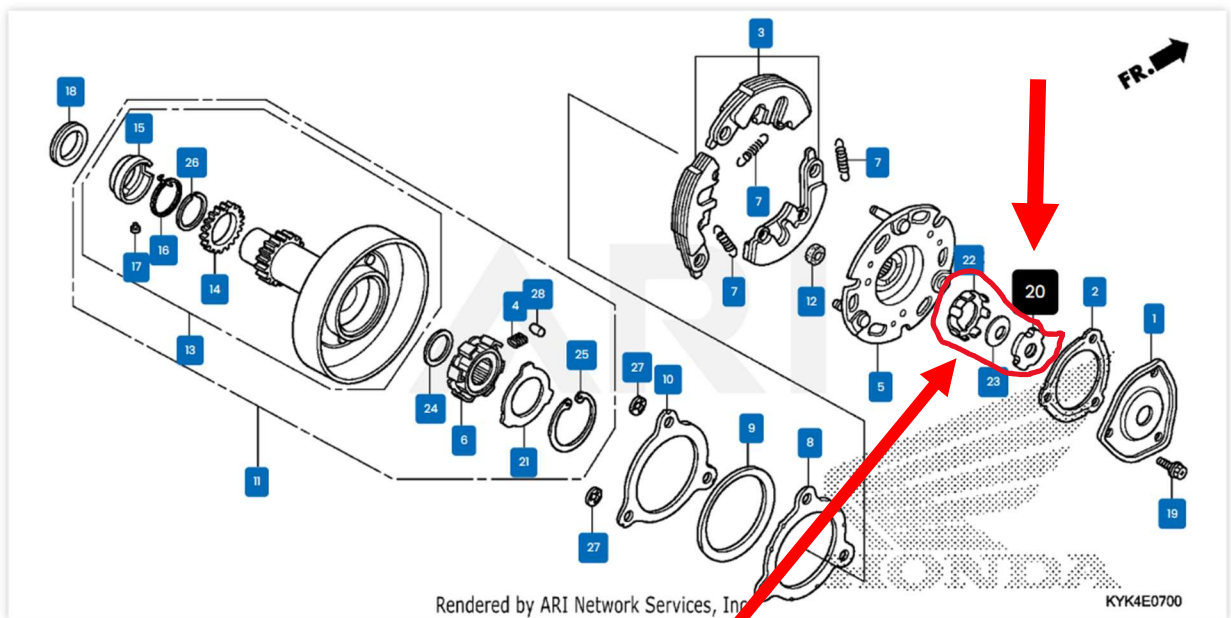

10. Remove the lock nut and 2 lock washers.

11. Remove the lifter plate bearing.

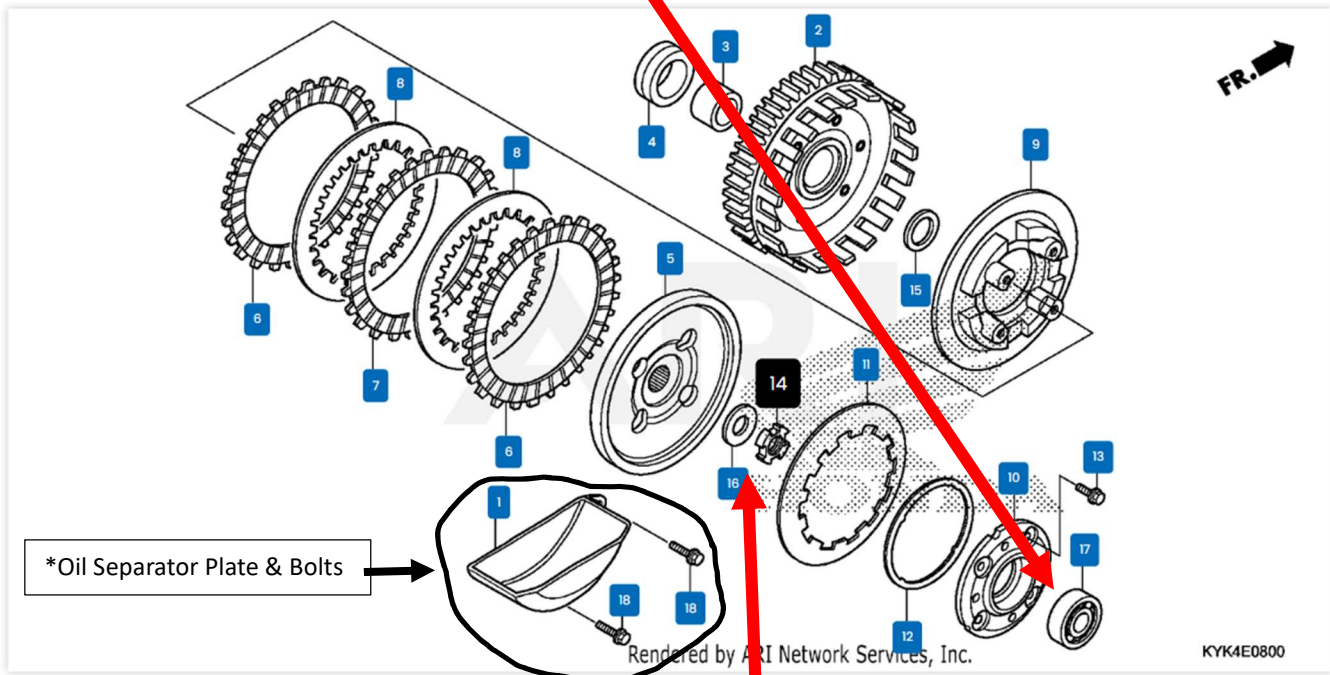

12. Remove the clutch locking nut and washer.

13. Remove the 2 oil separator plate bolts.

14. Remove the OEM primary gear, clutch assembly, and oil separator plate. Like below-

*TBparts clutch assembly is used for reference in this picture.

(Not the OEM clutch assembly)

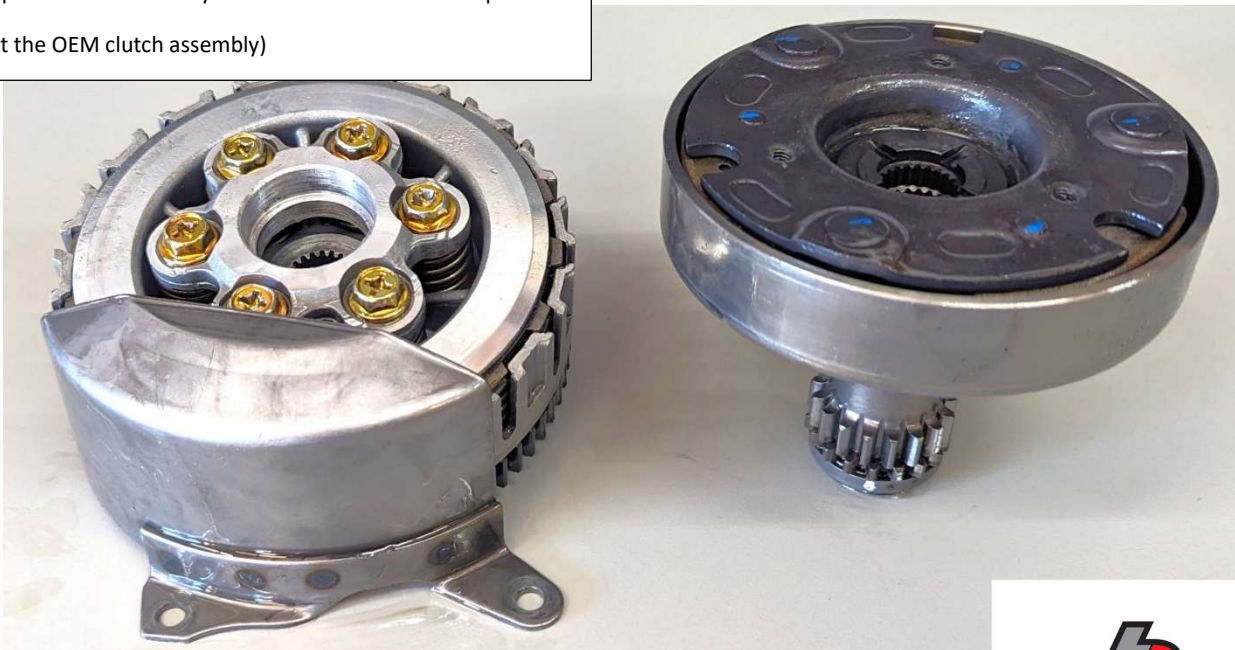

15. Before you install the new clutch assembly. A note from the diagram below. #3 Collar & #4 guide are reused. Additionally, #15 thrust washer is optional. (If you ever use a manual clutch lever on the bars you will need it)

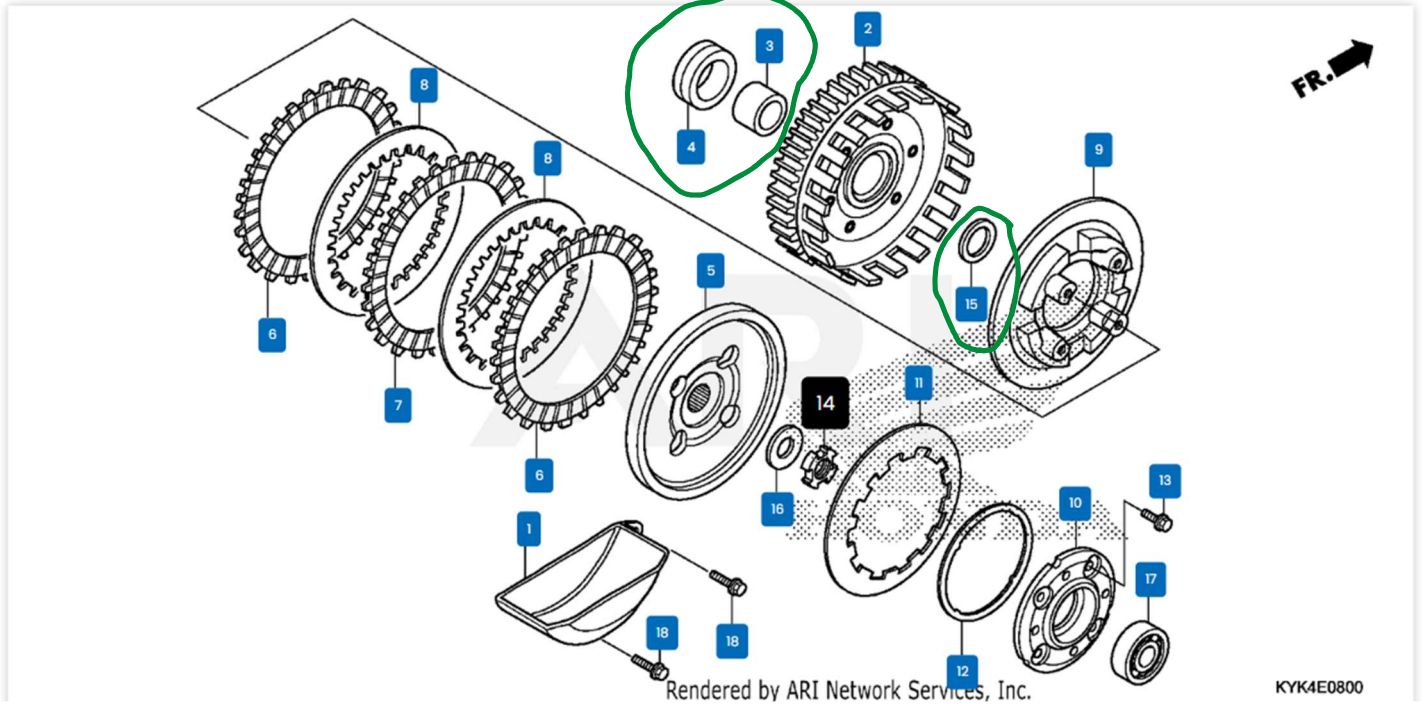

16. Use brake cleaner (or something similar) to remove all the oil off the threads for the locking clutch nut and one-way locking clutch nut. Do the same for the clutch locking nut and one-way clutch locking nut. This will prepare them for proper tightening later.

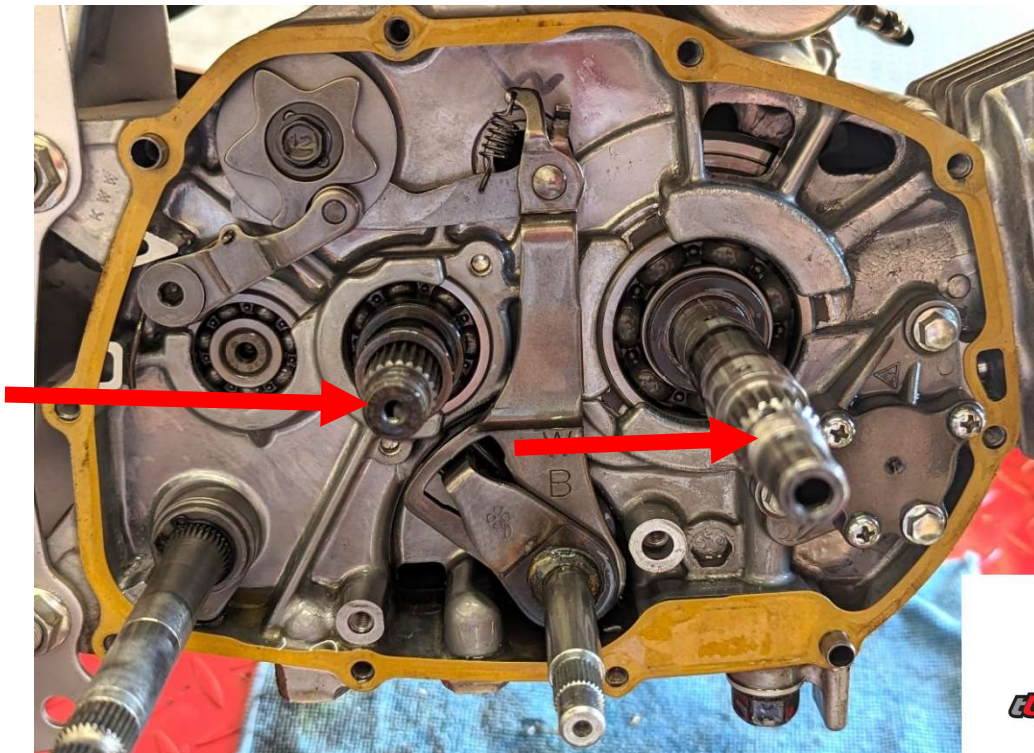

17. Leave these three spacers/collars in place.

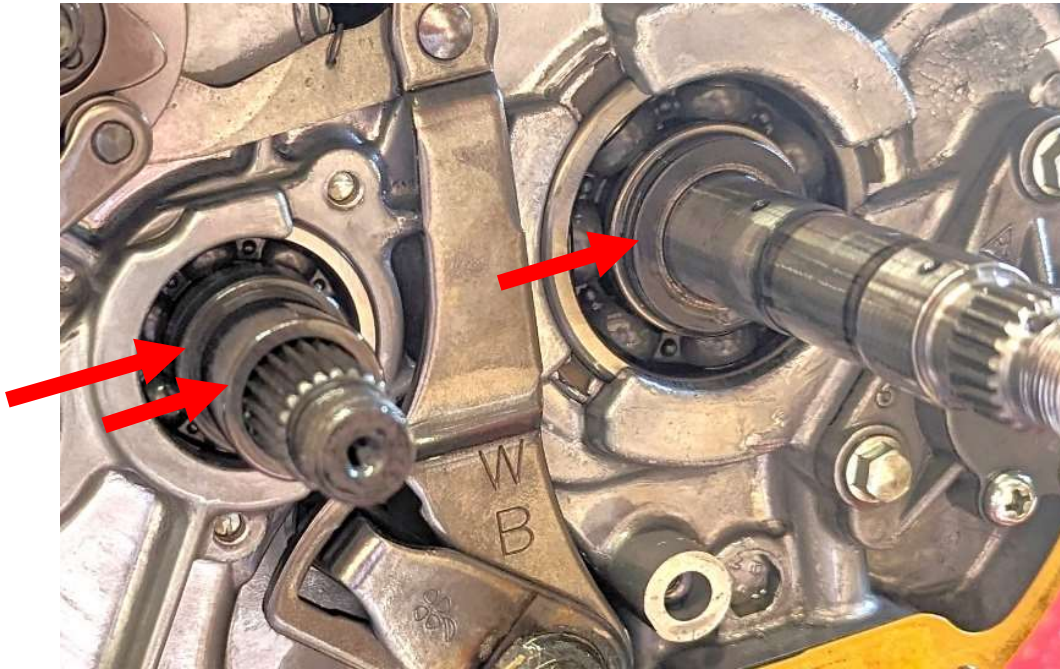

Installing the new TBparts Clutch Assembly TBW1599

18. Now you can install the new clutch assembly. Note - you must slide the clutch assembly, oil separator plate, and the primary gear/one way clutch on all at once. The clutch basket will bind up with the primary gear/one way clutch if not assembled in the correct order back into the engine just as it was removed. This can also be tricky because the transmission input shaft must align with the gears in the clutch basket and on the back of the clutch basket to the primary gear.

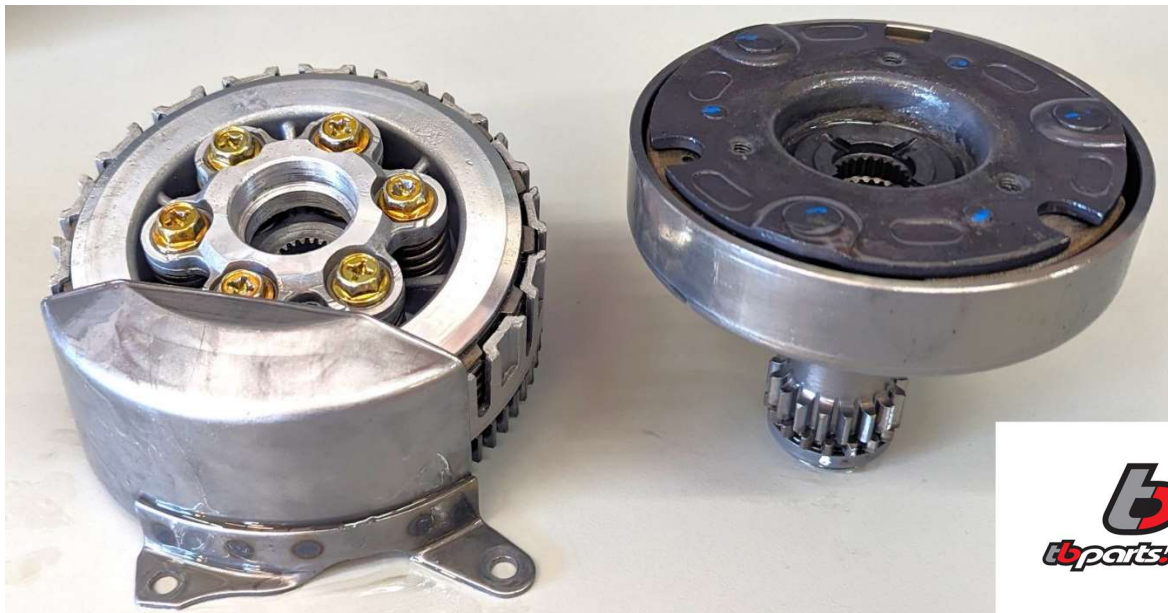

19. Tighten the 2 bolts that hold the oil separator plate in place. 80 INCH LBS
20. Install the clutch nut washer. Note - we included a narrower clutch nut washer to fit through our new lifter plate. (The OEM washer is about the same size as the new lifter plate hole, so it does not fit through well)

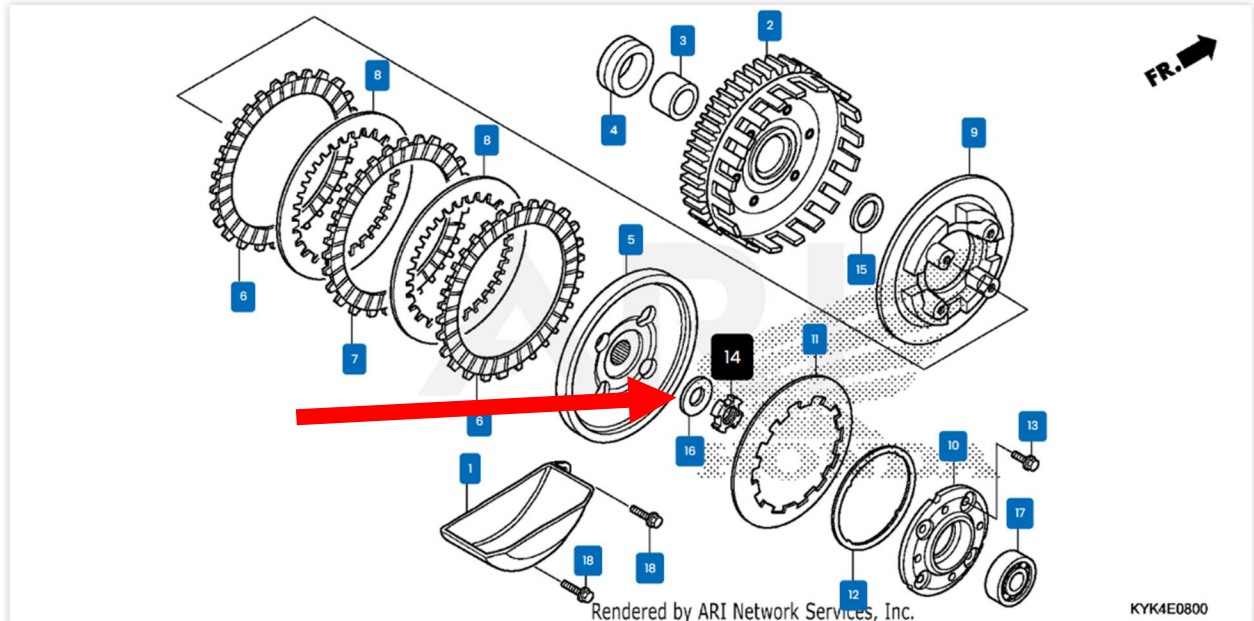

21. Next apply red thread lock to the cleaned/oil free locking clutch nut. This will help ensure there is no chance the nut can come loose. Then install and torque the locking clutch nut to 47 FT-LBS. (#14 in above diagram)
22. Double check the primary gear/one-way clutch is still seated in place. Then with the locking plate and convex lock washer in place torque the one-way clutch lock nut to 40 FT-LBS. Be sure to use one of the lock plate tabs so the nut cannot back off.

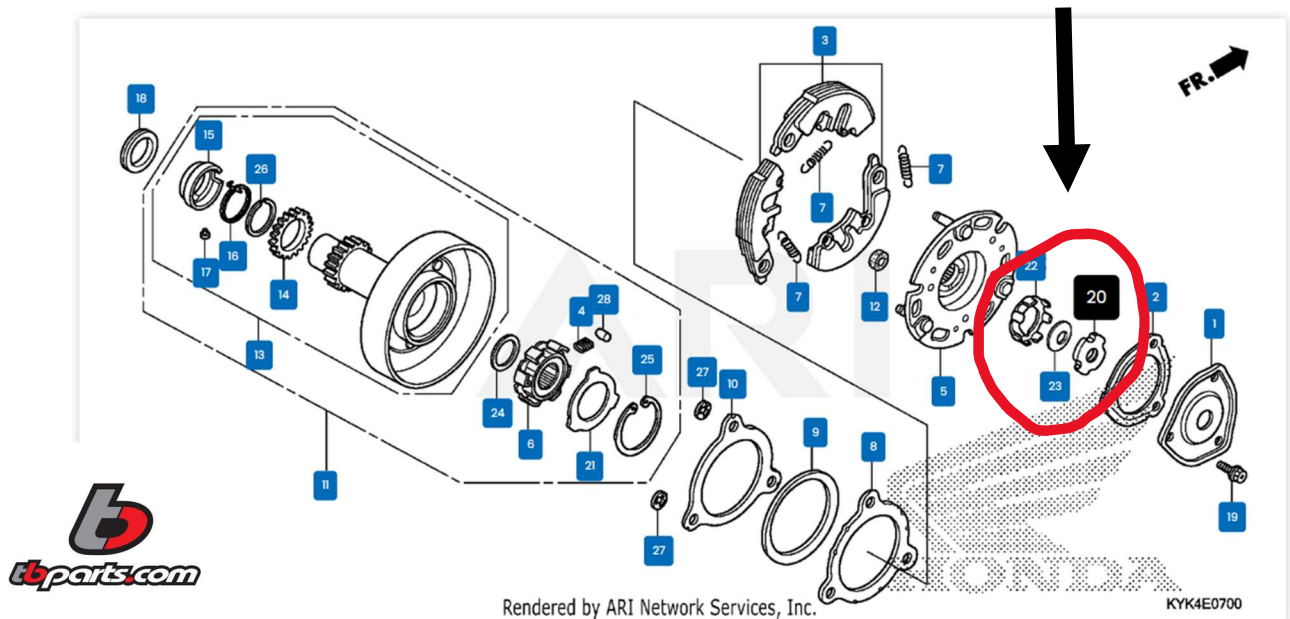

23. Bolt the one-way clutch cover and gasket back on using the 3 original bolts. 65 INCH LBS
24. Install the OEM lifer plate bearing. Make sure it is seated 100% into the lifer plate.
25. Install the lifer cam (picture below for reference). This can be tricky, so if you lean the bike backward and put a bunch of grease on the lifer plate bearing where the lifer cam goes it will help hold it in place.

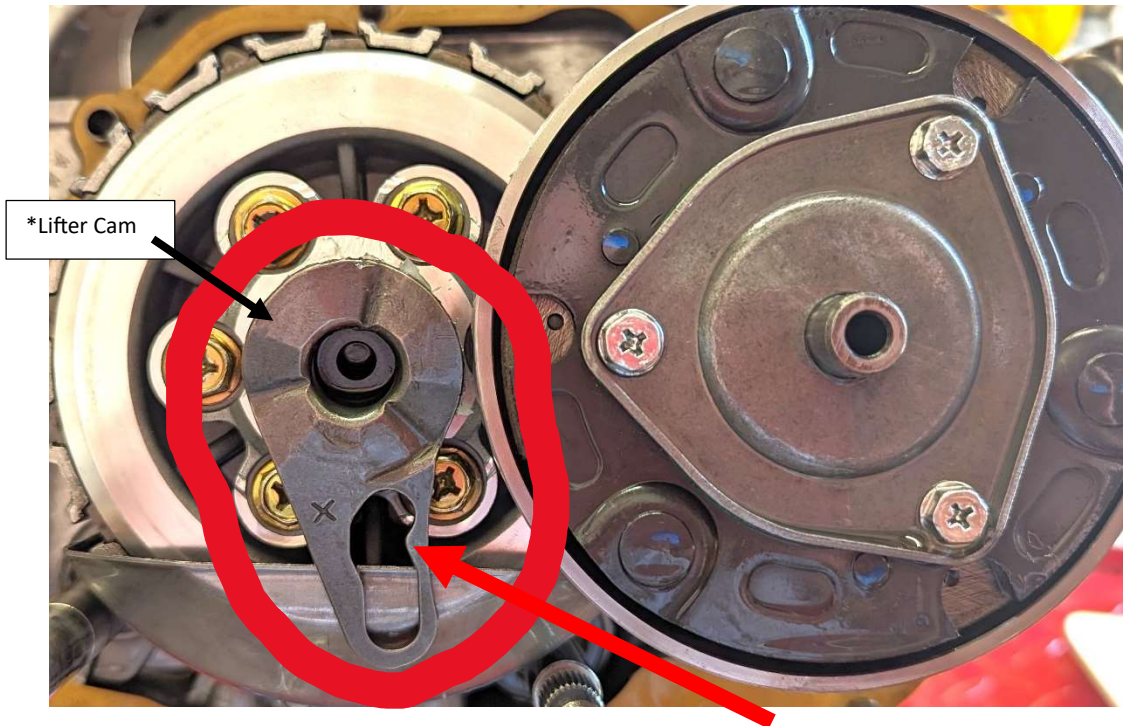

26. Install the clutch lever/arm. It must land here on the lifer cam.

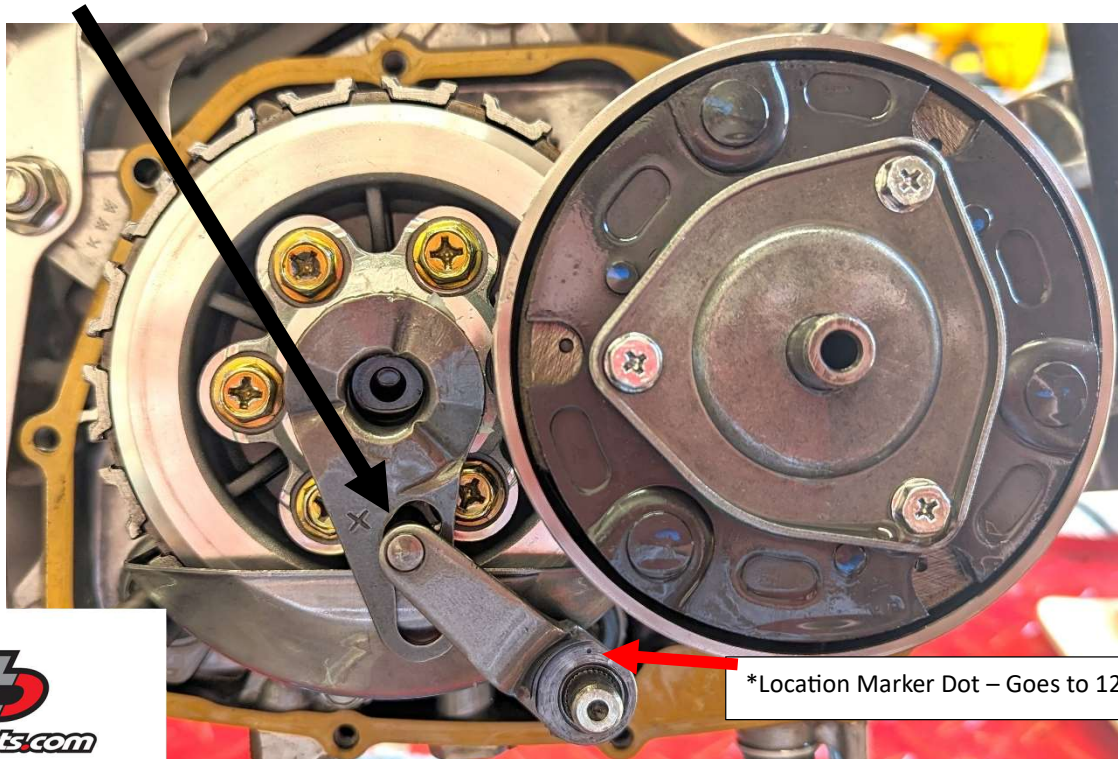

27. For ease of installation, we put the 2 dowel pins in on the engine side and hang the clutch cover gasket on them on the engine side. (Make sure all gasket surfaces are prepped)
28. Install the clutch adjuster bolt, lifter plate, and retainer/bearing plate into the back of the clutch cover. (Two photos for reference below)

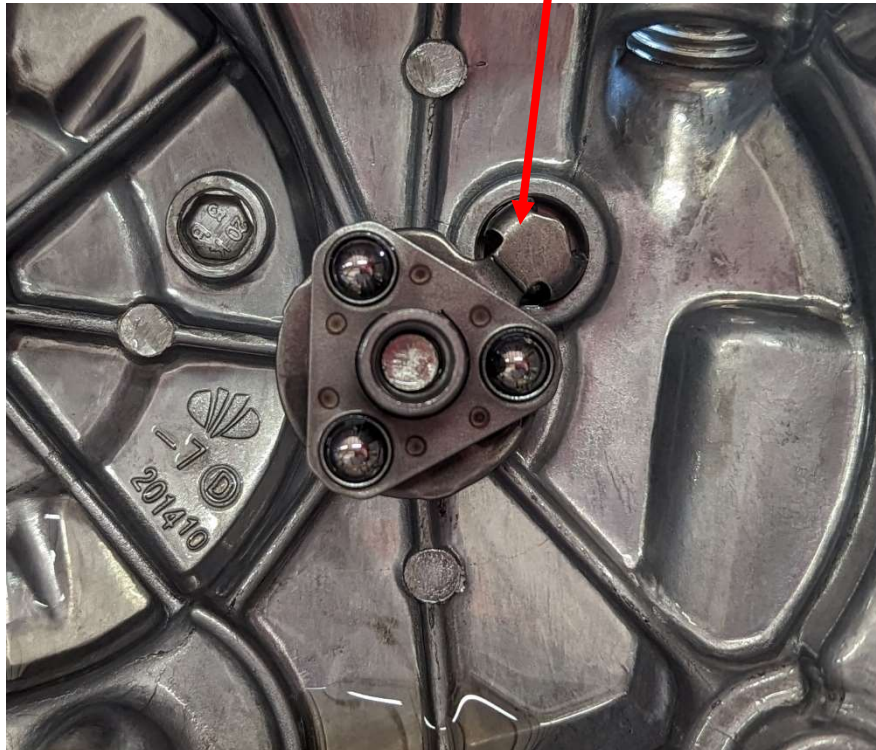
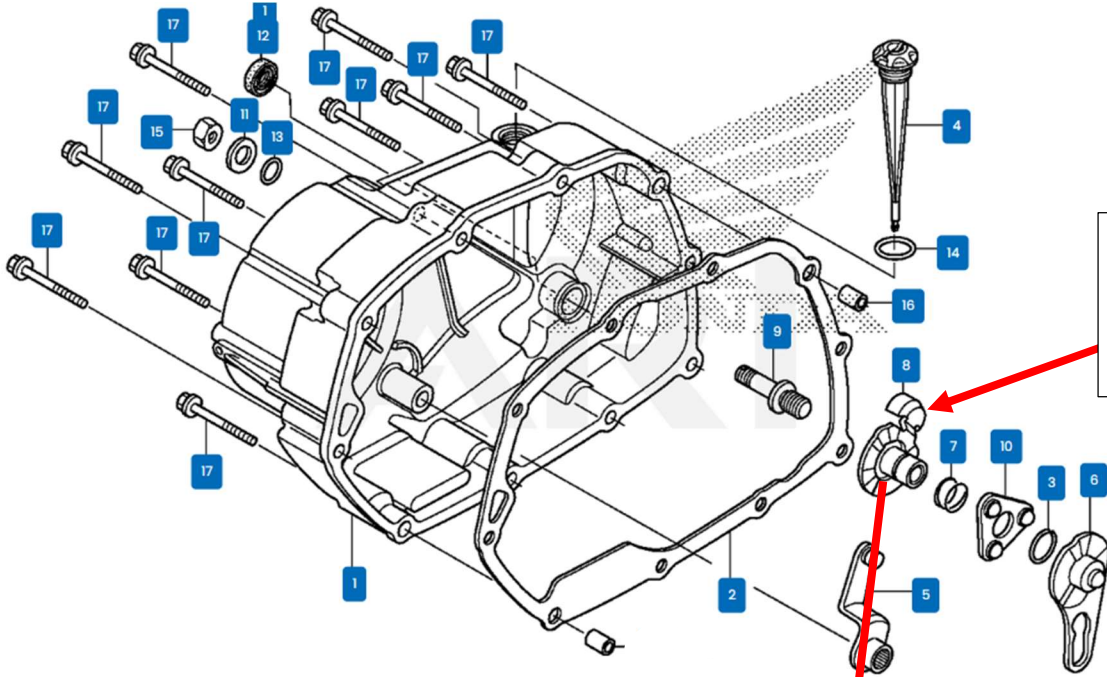

29. Make sure the clutch adjustment is all the way out. From the outside of the cover turn the clutch adjustment bolt clockwise until tight. This will max out the adjustment making it easier to install.
30. Install the clutch cover. Then tighten all 10 bolts that hold it in place. 80 INCH LBS
31. Reinstall your peg bar, skid plate (if equipped), brakes, and kick starter. Refill with the appropriate amount of wet clutch approved motorcycle oil. (If you do not use wet clutch approved oil it will prematurely wear your clutch plates)

Honda CRF110 - Adjusting the Clutch

- Leave $1/16$ – $1/8$ turn of play into the clutch adjustment. Not enough play and the clutch will slip when you shift. Too much play and it will shift rough, hard, or notchy.
- Clockwise is more play. Counterclockwise is less play.

