











ASSEMBLY INSTRUCTIONS

800/900-10 DRESSER

Caution: Please fully read instructions before unpacking assembly parts.

1. We recommend that you assemble this product with the assistance of another person to avoid injury and prevent damage to the product.
2. Be sure to check all packing materials carefully for small parts or hardware that may have come loose inside the carton during shipment.
3. Please put all parts on a non-abrasive surface before assembling. Follow the steps to assemble your newly purchased product correctly.

Code	Parts	Qty
A	Dresser 	1pc
B	Leg 	4pcs
C	Center Support Leg 	1pc

Code	Hardware	Qty
1	$\Phi 1/4$ "x2-1/4"L Allen Head Bolt 	4pcs
2	$\Phi 1/4$ " Spring Washer 	4pcs
3	$\Phi 1/4$ " Flat Washer 	4pcs
4	$\Phi 1/4$ " Allen Wrench 	1pc
5	Tipping Restraint Kit 	1set
6	Handle (Pre-installed) 	6pcs
7	Screw For Handle M4*22mm (Pre-installed) 	12pcs

STEP 1

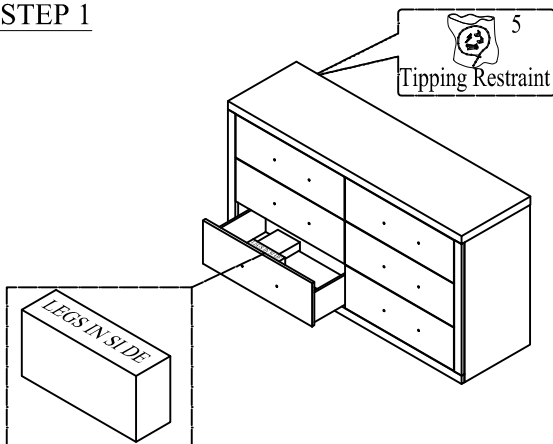

STEP 2

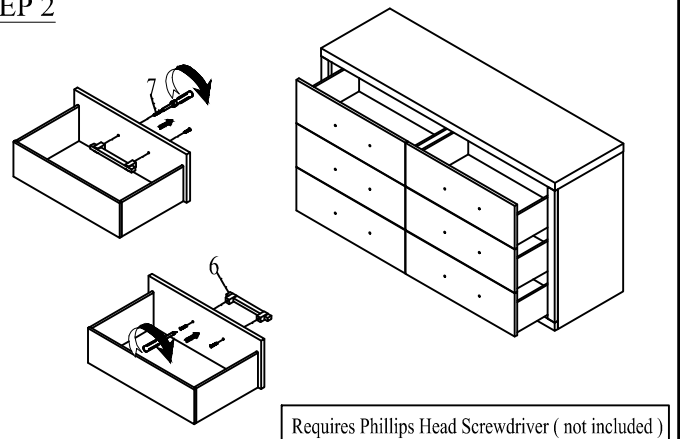

STEP 3

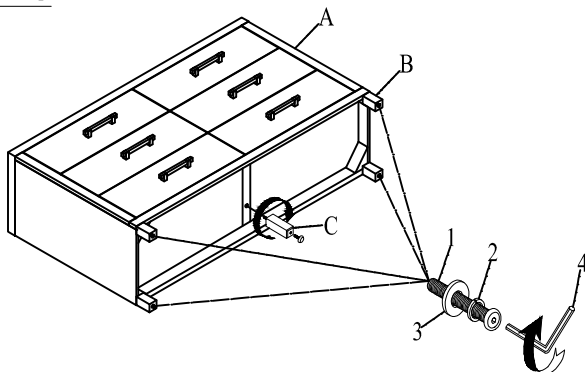

COMPLETE

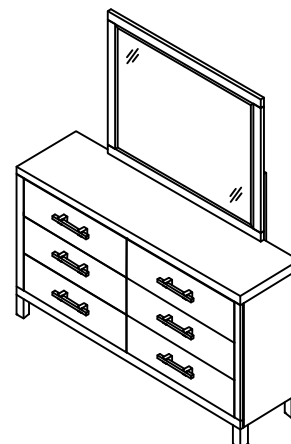

Hardware Pack Location(s):

800/900-10 DRESSER



1 of 1







MADE IN VIETNAM

INSTRUCTIONS D'ASSEMBLAGE

800/900-10 COMMODE

1. Nous vous recommandons d'assembler ce produit avec l'aide d'une autre personne afin de faciliter l'assemblage et d'éviter les blessures.
2. Ne jetez rien des produits d'emballage et du contenu de la boîte jusqu'à ce l'assemblage soit terminé, afin d'éviter de jeter par mégarde de petites pièces ou des morceaux.

Code	Liste Des Pieces	Qté
A	Commode 	1pc
B	Pied 	4pcs
C	Pied Support 	1pc

Code	Liste De Quincaillerie	Qté
1	Ø1/4"x2-1/4"L Boulon Jcbc 	4pcs
2	Ø1/4" Rondelle Ressort 	4pcs
3	Ø1/4" Rondelle Plste 	4pcs
4	Ø1/4" Clé Allen 	1pc
5	Système De Quincaillerie Anti-Bascul Ement 	1set
6	Poignée (Pre-installé) 	6pcs
7	Vis Pour Poignée M4*22mm (Pre-installé) 	12pcs

ÉTAPE 1

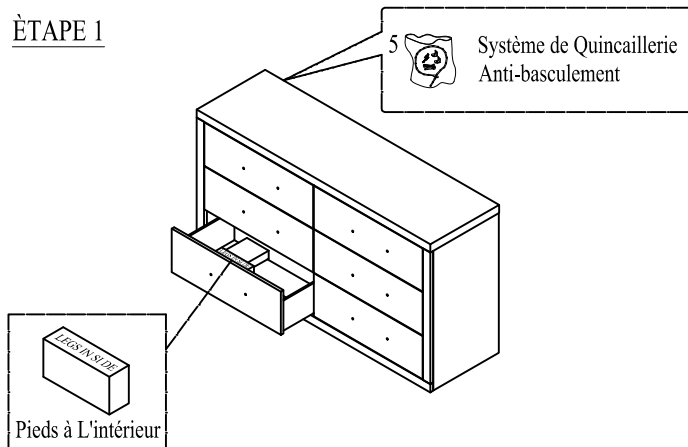

ÉTAPE 2

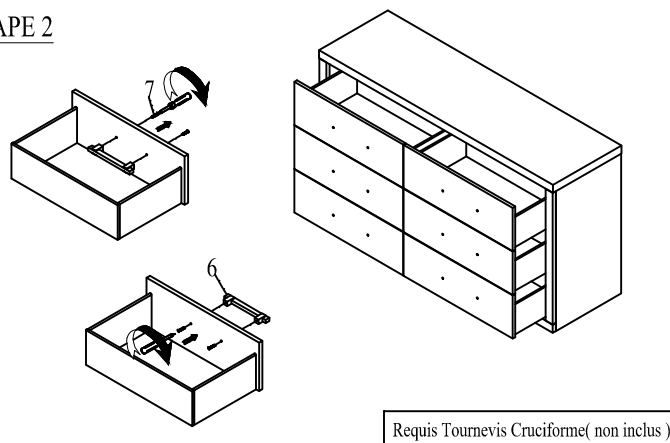

ÉTAPE 3

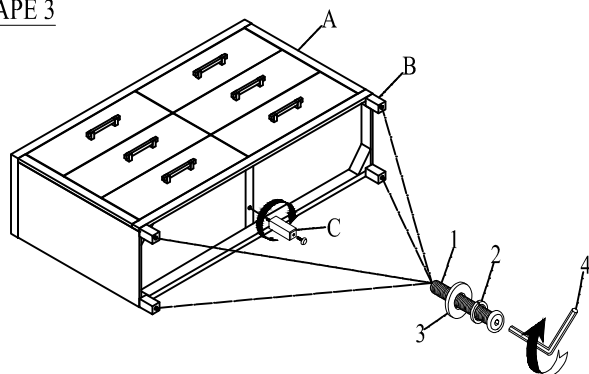

COMPLÉTÉ

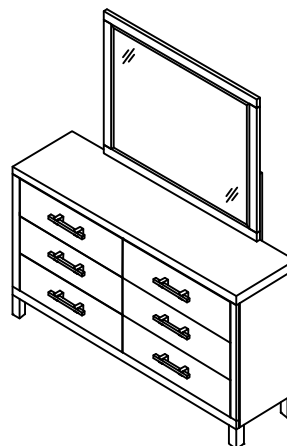

Emplacement Quincaillerie:

800/900-10 COMMODE

1 of 1

FABRIQUÉ AU VIETNAM