

ASSEMBLY INSTRUCTIONS (INSTRUCTIONS D'ASSEMBLAGE)

ITEM NO.: RICOXCTB/RICO LIFT COFFEE TABLE



NO ARTICLE: RICOXCTB/TABLE À CAFÉ RICO

Thank you for purchasing this quality product. Be sure to check all packing material carefully for small parts, which may have come loose inside the carton during shipment. Identify and count all parts and compare with the parts list below.
(Merci d'avoir acheté ce produit de qualité. Assurez-vous de vérifier le carton d'emballage, car les petites pièces auraient pu se déplacer pendant le transport. Comptez toutes les pièces et comparez-les à la liste ci-dessous)



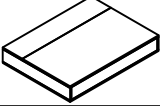
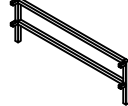
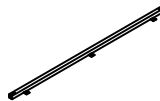

Notes:

- 1: Estimated assembled time 20 minutes.
(L'assemblage devrait prendre 20 minutes environ.)
- 2: Do not tighten bolts until completely assembled.
(Attendre avant de serrer complètement tous les boulons.)
- 3: When ready to tighten the bolts, ensure to tighten on a flat and level surface.
(Pour serrer complètement tous les boulons, s'assurer d'être sur une surface plane et nivelée.)

PARTS LIST (LISTE DES PIÈCES)

1		COFFEE TABLE TOP (Dessus de table à café)	1PC (1PCE)
2		COFFEE TABLE SIDE FRAME (Armature latérale - Table à café)	2 PCS (2 PCES)
3		COFFEE TABLE UPPER CONNECTING BAR (Barre de liaison en haut - Table à café)	2 PCS (2 PCES)
4		COFFEE TABLE LOWER CONNECTING BAR (Barre de liaison en bas - Table à café)	2 PCS (2 PCES)

HARDWARE LIST (LISTE DES OUTILS)

A		BOLT(BOULON) (M6X15mmL)	22 PCS (22 PCES)
B		LOCK WASHER (RONDELLE FREIN) (M6)	22 PCS (22 PCES)
C		WASHER(RONDELLE) (M6)	22 PCS (22 PCES)
D		ALLEN KEY (CLÉ HEXAGONALE) (4mm)	1PC (1PCE)

Step 1/ETAPE 1

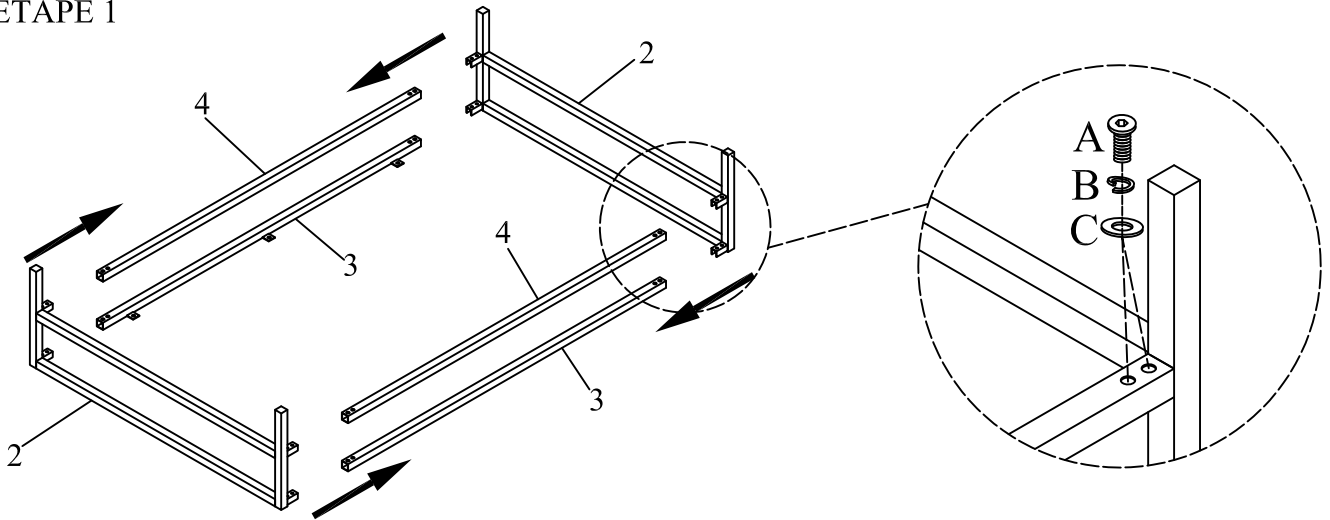

Step 2/ETAPE 2

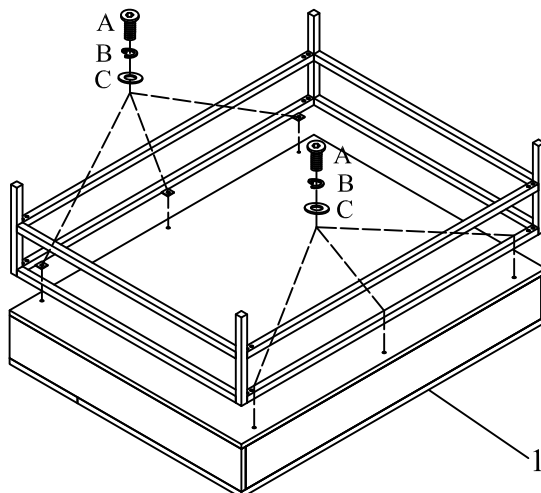

Step 3/ETAPE 3

